

# M79 / M79C

## Double-Balanced Mixer

Rev. V3

### Features

- LO 5 TO 18 GHz
- RF 7 TO 18 GHz
- IF DC TO 3000 MHz
- LO DRIVE: +10 dBm (NOMINAL)
- WIDE BANDWIDTH
- LOW NOISE FIGURE

### Description

The M79 is a double balanced mixer, designed for use in military, commercial and test equipment applications. This mixer can also be used as a phase detector or bi-phase modulator since the IF port is DC coupled to the diodes. Environmental screening available to MIL-STD-202, and MIL-DTL-28837, consult factory.

### Product Image

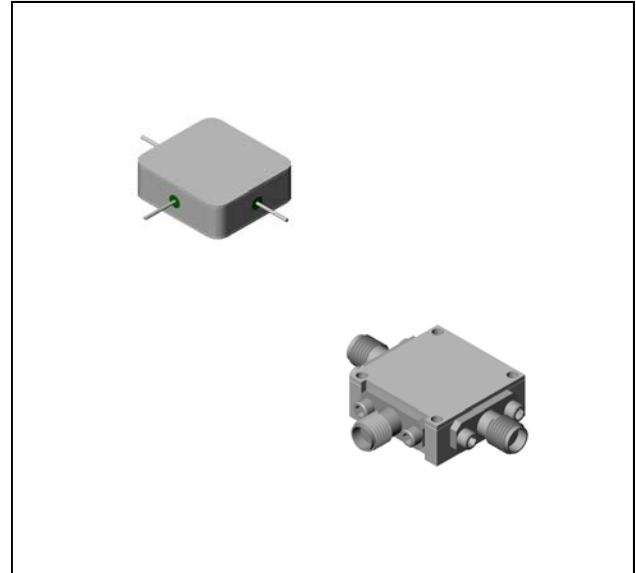

### Ordering Information

Part Number	Package
M79	Minpac
M79C	SMA Connectorized

### Electrical Specifications: $Z_0 = 50\Omega$ $Lo = +10$ dBm (Downconverter application only)

Parameter	Test Conditions	Units	Typical	Guaranteed	
				+25°C	-54° to +85°C
SSB Conversion Loss (max) & SSB Noise Figure (max)	fR = 7 to 16 GHz, fL = 6 to 17 GHz, fl = 30 to 1000 MHz	dB	5.7	7.5	8.0
	fR = 7 to 16 GHz, fL = 5 to 18 GHz, fl = 30 to 2000 MHz	dB	6.0	8.0	8.5
	fR = 8 to 16 GHz, fL = 5 to 16 GHz, fl = 30 to 3000 MHz	dB	6.0	8.0	8.5
	fR = 16 to 18 GHz, fL = 13 to 18 GHz, fl = 30 to 3000 MHz	dB	7.0	9.0	9.5
Isolation, L to R (min)	fL = 5 to 14 GHz	dB	35	22	20
	fL = 14 to 18 GHz	dB	33	15	13
Isolation, L to I (min)	fL = 5 to 8 GHz	dB	34	22	20
	fL = 8 to 18 GHz	dB	24	12	10
1 dB Conversion Comp.	fL = +10 dBm	dBm	+4		
Input IP3	fR1=13 GHz at -6 dBm, fR2=13.01GHz at -6 dBm, fL = 14 GHz at = 10 dBm	dBm	+14		

# M79 / M79C



## Double-Balanced Mixer

Rev. V3

### Absolute Maximum Ratings

Parameter	Absolute Maximum
Operating Temperature	-54°C to +100°C
Storage Temperature	-65°C to +100°C
Peak Input Power	+23 dBm max @ +25°C +20 dBm max @ +85°C
Peak Input Current	100 mA DC

### Typical Performance Curves

Conversion Loss vs. Input Power and Temperature

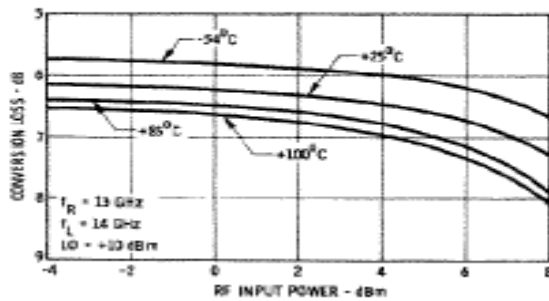

Conversion Loss vs. Frequency

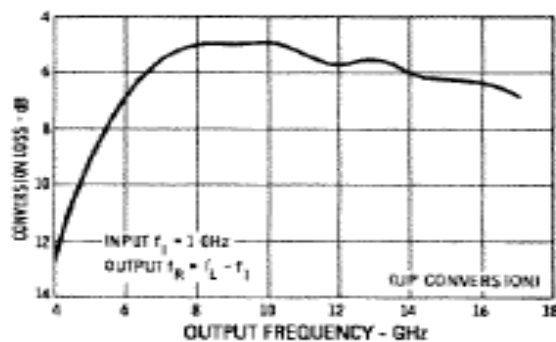

### Outline Drawing: Minpac \*

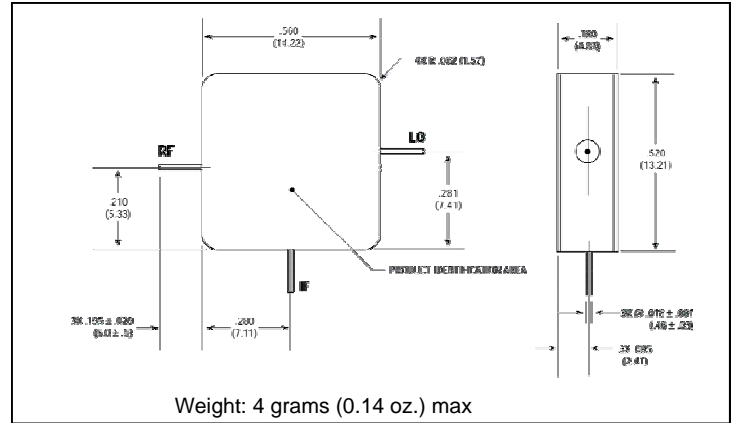

### Outline Drawing: SMA Connectorized \*

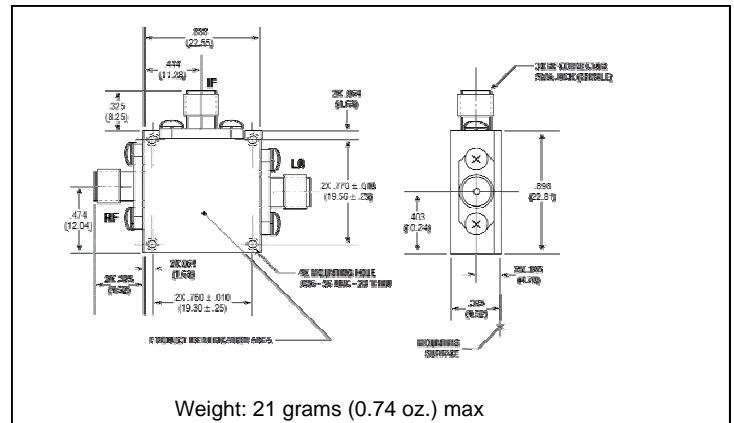

\* Dimensions are inches (millimeters) ±0.015 (0.38) unless otherwise specified.

Conversion Loss vs. LO Drive Power.

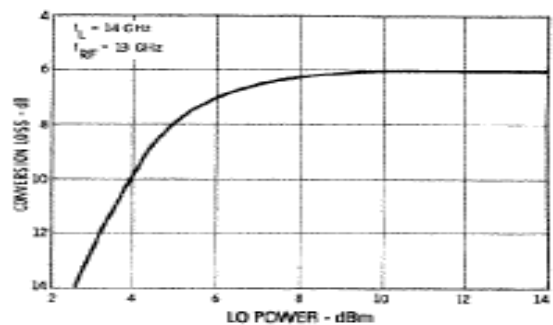

**ADVANCED:** Data Sheets contain information regarding a product M/A-COM Technology Solutions is considering for development. Performance is based on target specifications, simulated results, and/or prototype measurements. Commitment to develop is not guaranteed.  
**PRELIMINARY:** Data Sheets contain information regarding a product M/A-COM Technology Solutions has under development. Performance is based on engineering tests. Specifications are typical. Mechanical outline has been fixed. Engineering samples and/or test data may be available. Commitment to produce in volume is not guaranteed.

• **North America** Tel: 800.366.2266 • **Europe** Tel: +353.21.244.6400  
 • **India** Tel: +91.80.4155721 • **China** Tel: +86.21.2407.1588  
 Visit [www.macomtech.com](http://www.macomtech.com) for additional data sheets and product information.

M/A-COM Technology Solutions Inc. and its affiliates reserve the right to make changes to the product(s) or information contained herein without notice.

### Typical Performance Curves

#### Isolation

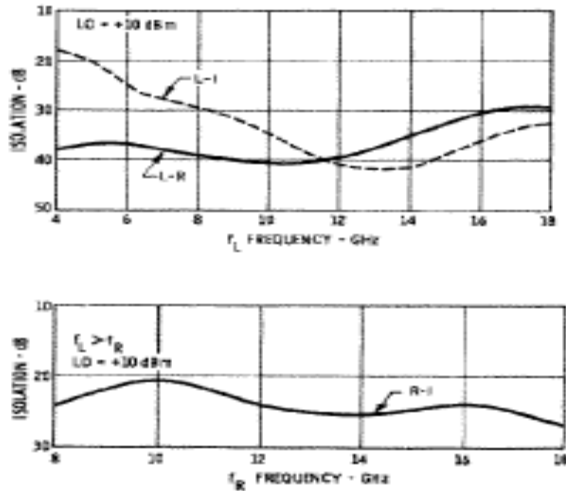

#### Conversion Loss vs. Frequency.

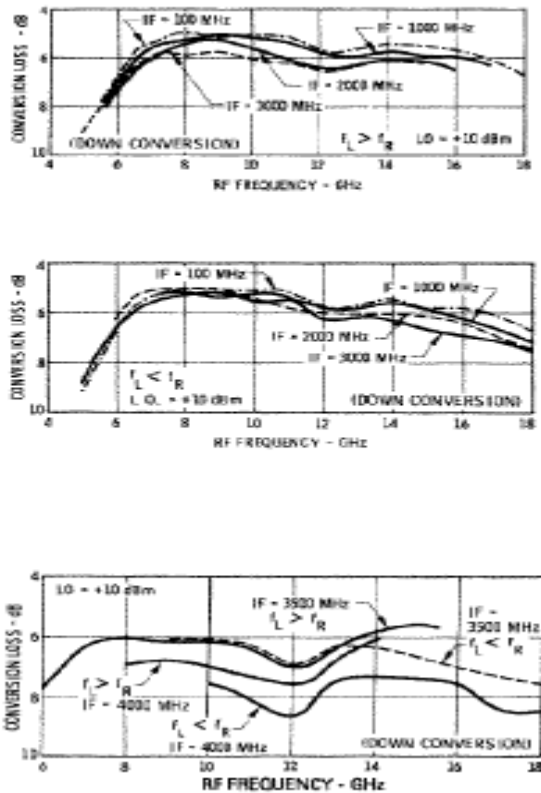

#### L-Port VSWR

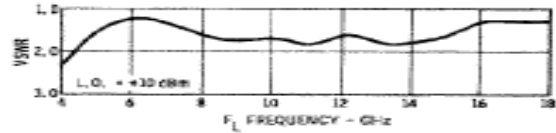

#### R-Port VSWR

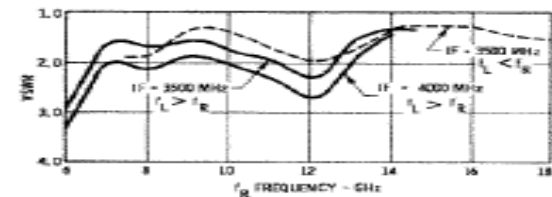
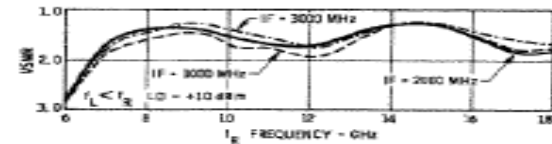
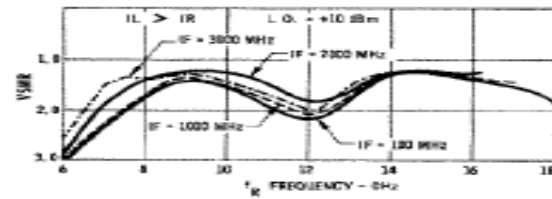

#### I-Port VSWR

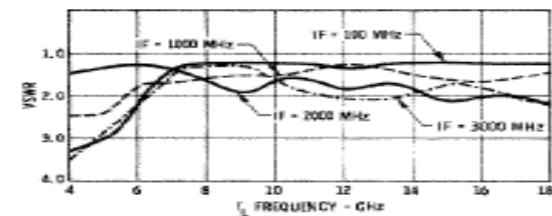
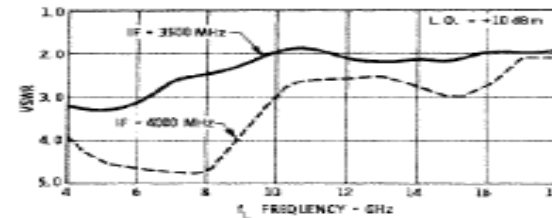

## Данный компонент на территории Российской Федерации

### Вы можете приобрести в компании MosChip.

Для оперативного оформления запроса Вам необходимо перейти по данной ссылке:

<http://moschip.ru/get-element>

Вы можете разместить у нас заказ для любого Вашего проекта, будь то серийное производство или разработка единичного прибора.

В нашем ассортименте представлены ведущие мировые производители активных и пассивных электронных компонентов.

Нашей специализацией является поставка электронной компонентной базы двойного назначения, продукции таких производителей как XILINX, Intel (ex.ALTERA), Vicor, Microchip, Texas Instruments, Analog Devices, Mini-Circuits, Amphenol, Glenair.

Сотрудничество с глобальными дистрибьюторами электронных компонентов, предоставляет возможность заказывать и получать с международных складов практически любой перечень компонентов в оптимальные для Вас сроки.

На всех этапах разработки и производства наши партнеры могут получить квалифицированную поддержку опытных инженеров.

Система менеджмента качества компании отвечает требованиям в соответствии с ГОСТ Р ИСО 9001, ГОСТ РВ 0015-002 и ЭС РД 009

### Офис по работе с юридическими лицами:

105318, г.Москва, ул.Щербаковская д.3, офис 1107, 1118, ДЦ «Щербаковский»

Телефон: +7 495 668-12-70 (многоканальный)

Факс: +7 495 668-12-70 (доб.304)

E-mail: [info@moschip.ru](mailto:info@moschip.ru)

Skype отдела продаж:

moschip.ru

moschip.ru\_4

moschip.ru\_6

moschip.ru\_9