

3-INPUT / 2-INPUT VIDEO SWITCH

■ GENERAL DESCRIPTION

The **NJM2508** is video switch for video and audio signal. It contains 3 input-1 output and 2 input-1 output video switch. One input terminal has clamp function and so is applied to fixed DC level of video signal. Its operating voltage is 4.75 to 13V and bandwidth is 10MHz. Crosstalk is 75dB (at $f = 4.43\text{MHz}$)

■ PACKAGE OUTLINE

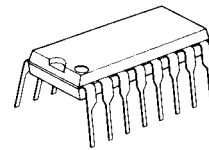

NJM2508D

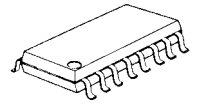

NJM2508M

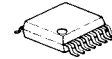

NJM2508V

■ FEATURES

- Operating Voltage (+4.75V to +13V)
- 3 Input-1 Output and 2 Input-1 Output
- Crosstalk 75dB (at 4.43MHz)
- Wide Frequency Range 10MHz (2V_{P-P} Input)
- Package Outline DIP16, DMP16, SSOP16
- Bipolar Technology

■ RECOMMENDED OPERATING CONDITION

- Operating Voltage V^+ 4.75V to 13.0V

■ APPLICATION

- VCR, Video Camera, AV-TV, Video Disk Player.

■ BLOCK DIAGRAM

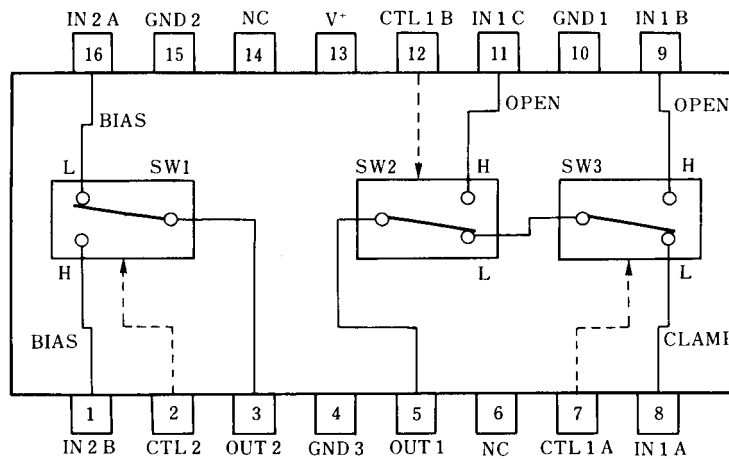

NJM2508D
NJM2508M
NJM2508V

NJM2508

■ ABSOLUTE MAXIMUM RATINGS

($T_a = 25^\circ\text{C}$)

PARAMETER	SYMBOL	RATINGS	UNIT
Supply Voltage	V^+	14	V
Power Dissipation	P_D	(DIP16) 700 (DMP16) 350 (SSOP16) 300	mW mW mW
Operating Temperature Range	T_{opr}	-40 to +85	$^\circ\text{C}$
Storage Temperature Range	T_{stg}	-40 to +125	$^\circ\text{C}$

■ ELECTRICAL CHARACTERISTICS

($V^+ = 5\text{V}$, $T_a = 25^\circ\text{C}$)

PARAMETER	SYMBOL	TEST CONDITION	MIN.	TYP.	MAX.	UNIT
Operating Current 1	I_{CC1}	$V^+ = 5\text{V}$ (Note1)	6.6	9.4	12.3	mA
Operating Current 2	I_{CC2}	$V^+ = 9\text{V}$ (Note1)	8.0	11.5	15.0	mA
Voltage Gain	G_V	$V_I = 2V_{P.P.} / 100\text{kHz}$, V_O / V_I	-0.6	-0.1	+0.4	dB
Frequency Response	G_f	$V_I = 2V_{P.P.}$, V_O (10MHz / 100kHz)	-1.0	0	+1.0	dB
Differential Gain	DG	$V_I = 2V_{P.P.}$, Staircase Signal	-	0.3	-	%
Differential Phase	DP	$V_I = 2V_{P.P.}$, Staircase Signal	-	0.3	-	deg
Output offset Voltage	V_{OS}	(Note2)	-10	0	+10	mV
Crosstalk	CT	$V_I = 2V_{P.P.}$, 4.43MHz, V_O / V_I	-	-75	-	dB
Switch Change Voltage	V_{CH}	All inside SW : ON	2.5	-	-	V
Switch Change Voltage	V_{CL}	All inside SW : OFF	-	-	1.0	V

(Note1) $S1 = S2 = S3 = S4 = S5 = S6 = S7 = 1$

(Note2) Output DC Voltage Difference is tested on $S6 = 1 \rightarrow 2$, $S1 = S2 = S3 = S4 = S5 = 1$, $S8 = 2$ and $S7 = 1$

■ TEST CIRCUIT

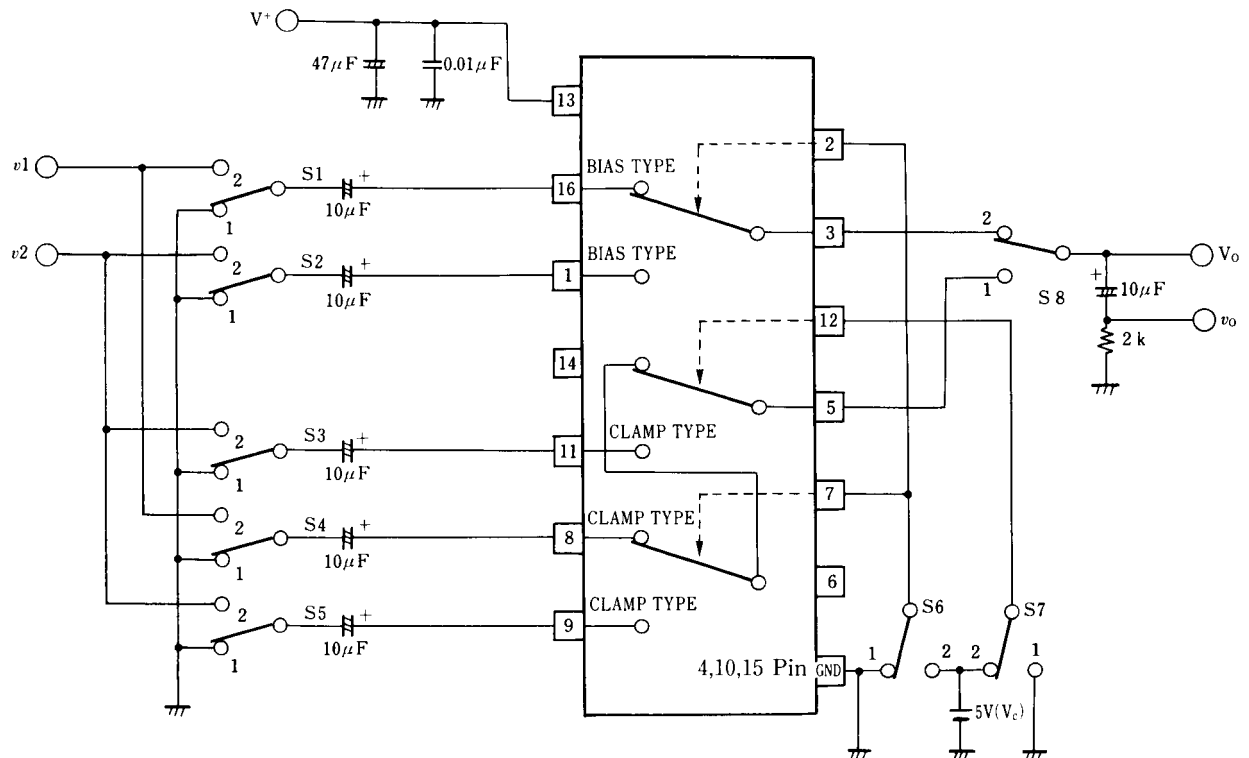

■ PIN FUNCTION

PIN No.	PIN NAME	DC VOLTAGE	INSIDE EQUIVALENT CIRCUIT
16 1	IN 2 A IN 2 B [Input]	2.5V	
8	IN 1 A [Input]	1.5V	
9 11	IN 1 B IN 1 C [Input]		
7 12 2	CTL 1 A CTL 1 B CTL 2 [Control]		
5	OUT1 [Output]	1.8V	
3	OUT2 [Output]	0.8V	
13	V ⁺	5V	
15 4 10	GND 1 GND 2 GND 3		

■ TYPICAL CHARACTERISTICS (Ta = +25°C)

Operating Current vs. Operating Voltage

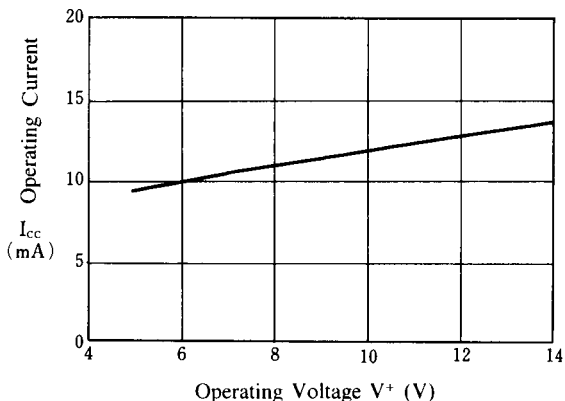

Operating Current vs. Ambient Temperature

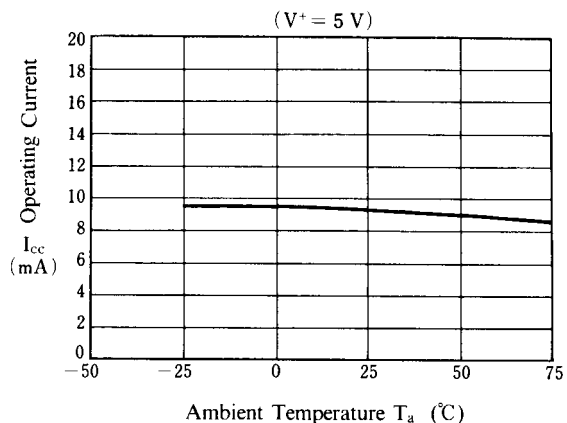

Operating Current vs. Ambient Temperature

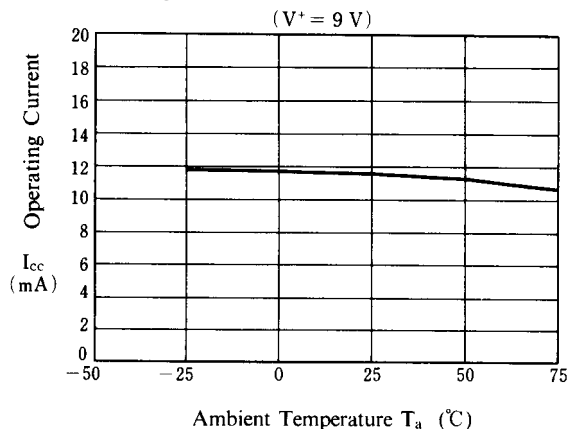

Voltage Gain vs. Operating Voltage

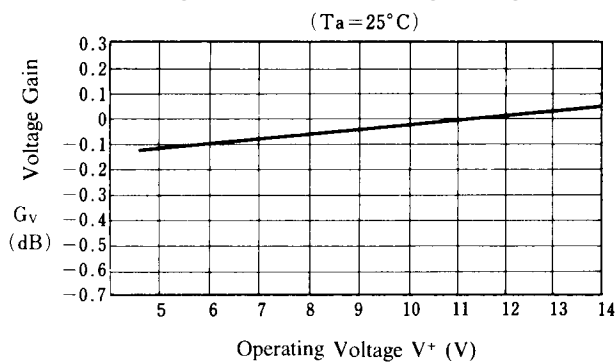

Voltage Gain vs. Frequency

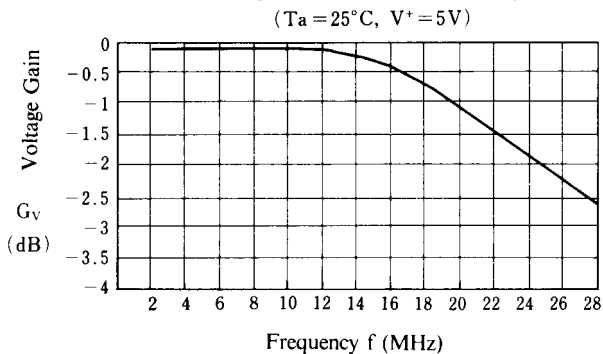

Voltage Gain vs. Ambient Temperature

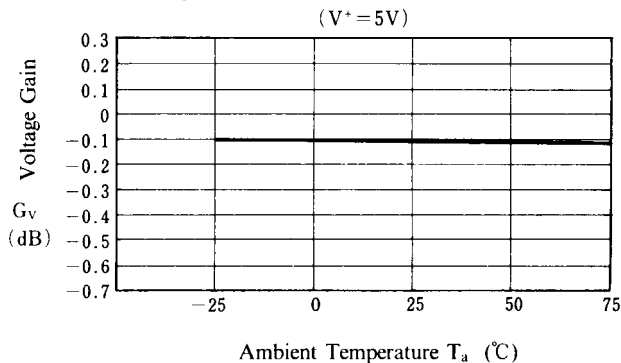

■ TYPICAL CHARACTERISTICS (Ta = +25°C)

Frequency Response vs. Operating Voltage

(Ta = 25°C)

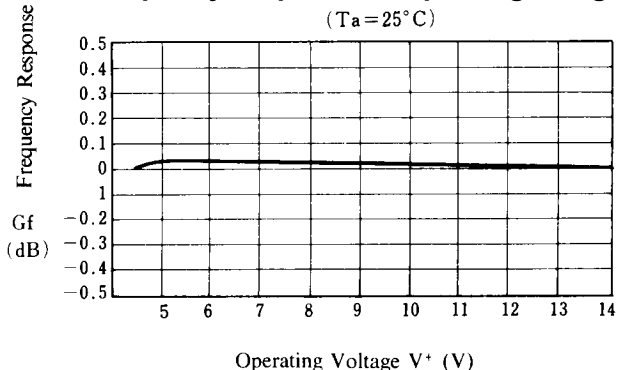

Frequency Response vs. Ambient Temperature

(V+ = 5V)

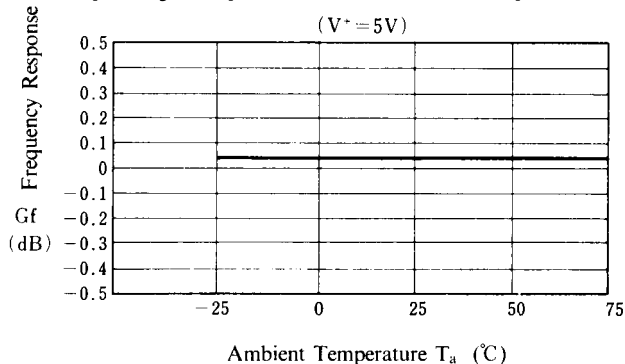

Offset Voltage vs. Operating Voltage

(Ta = 25°C)

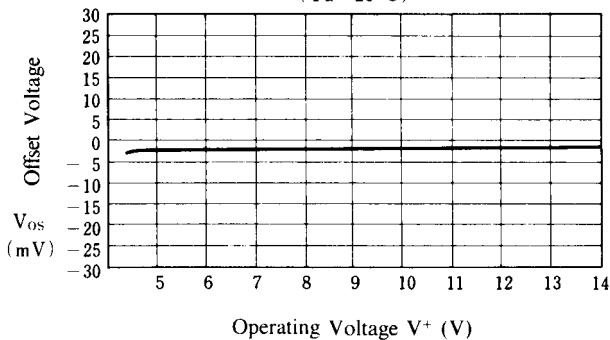

Offset Voltage vs. Ambient Temperature

(V+ = 5V)

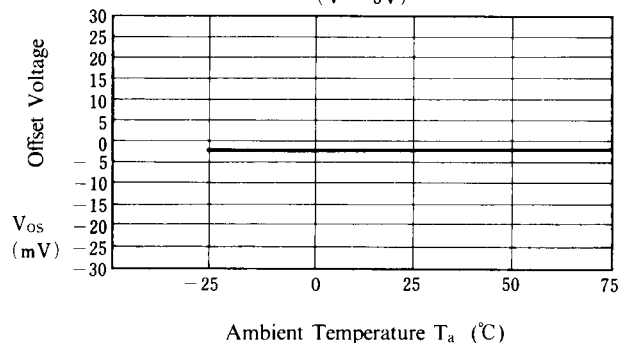

Switch Change Voltage vs. Operating Voltage

(Ta = 25°C)

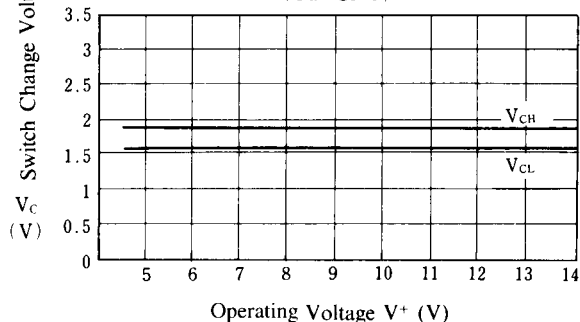

Switch Change Voltage vs. Ambient Temperature

(V+ = 5V)

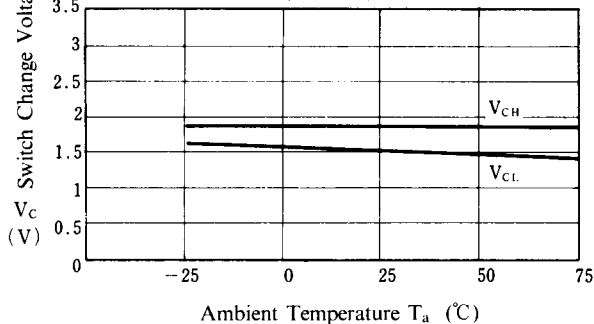

■ TYPICAL CHARACTERISTICS (Ta = +25°C)

Differential Gain vs. Operating Voltage

(Ta = 25°C)

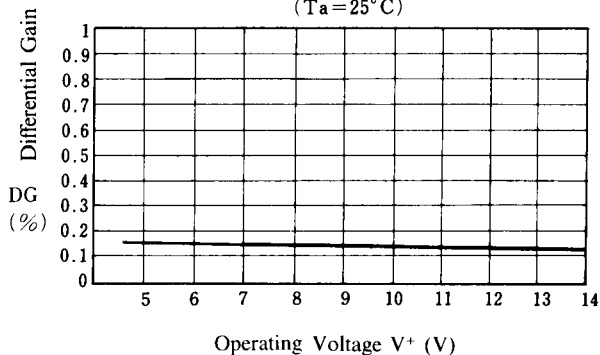

Differential Phase vs. Operating Voltage

(Ta = 25°C)

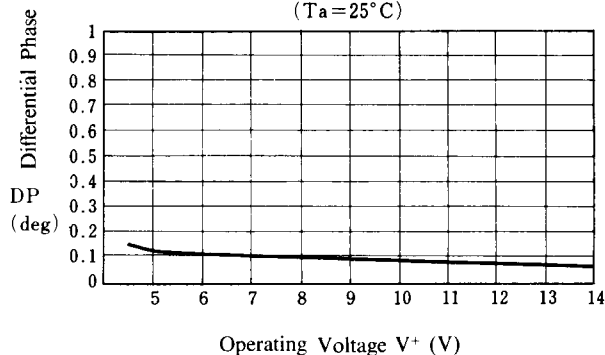

Differential Gain vs. Ambient Temperature

(V+ = 5V)

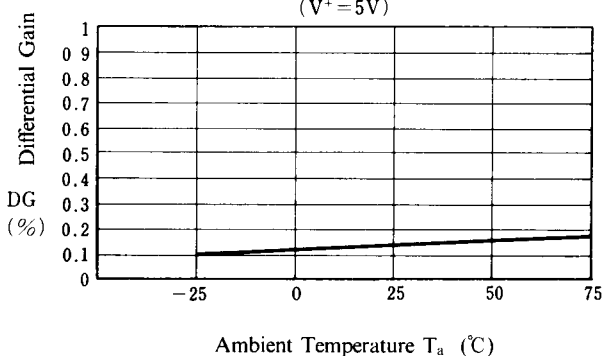

Differential Phase vs. Ambient Temperature

(V+ = 5V)

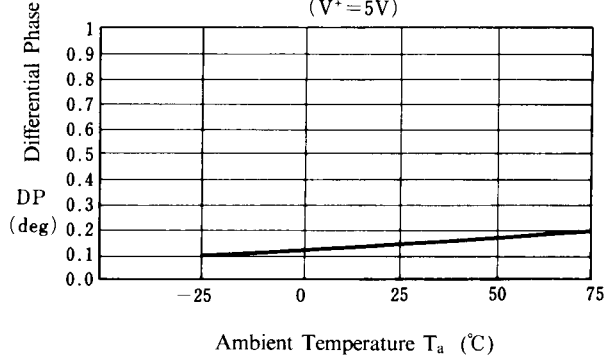

Differential Gain vs. Load

(Ta = 25°C, V+ = 5V)

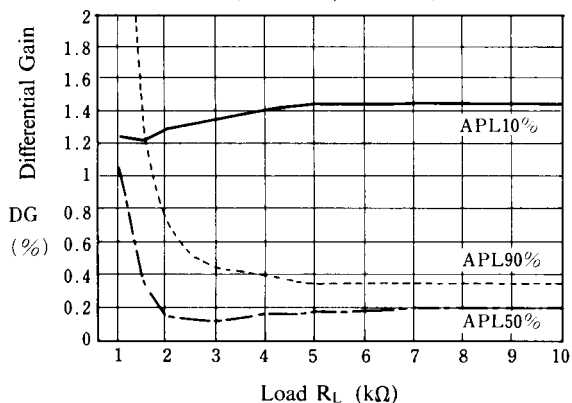

Differential Phase vs. Load

(Ta = 25°C, V+ = 5V)

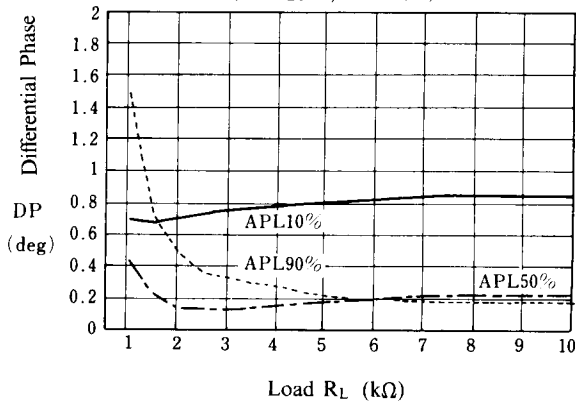

■ TYPICAL CHARACTERISTICS (Ta = +25°C)

Differential Gain vs. APL

(Ta = 25°C, V+ = 5V)

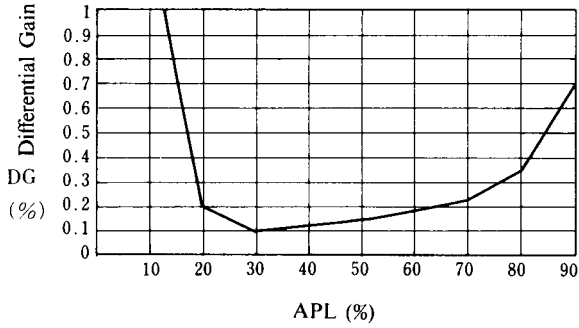

Differential Phase vs. APL

(Ta = 25°C, V+ = 5V)

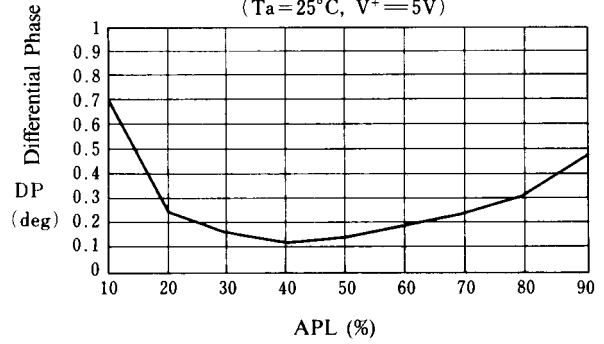

Differential Gain vs. Load

(Ta = 25°C, V+ = 5V)

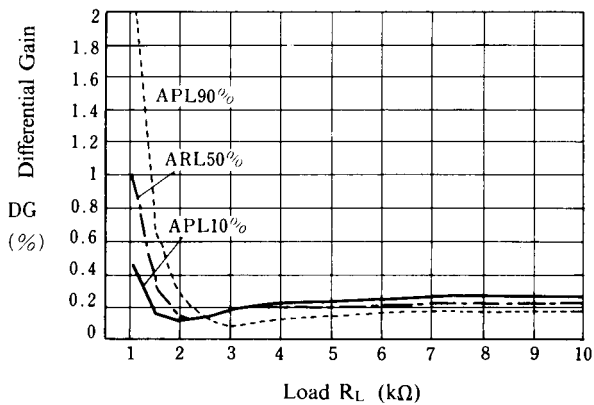

Differential Phase vs. Load

(Ta = 25°C, V+ = 5V)

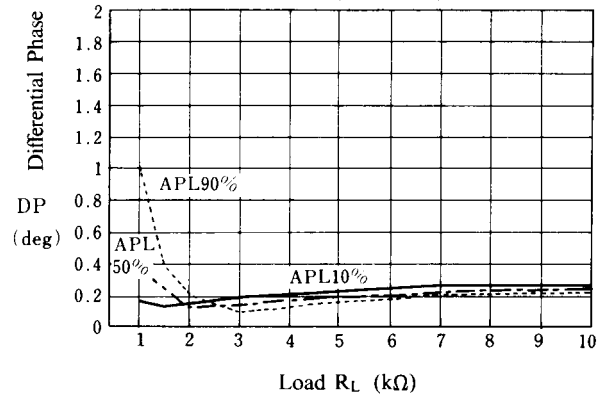

Differential Gain vs. APL

(Ta = 25°C, V+ = 5V)

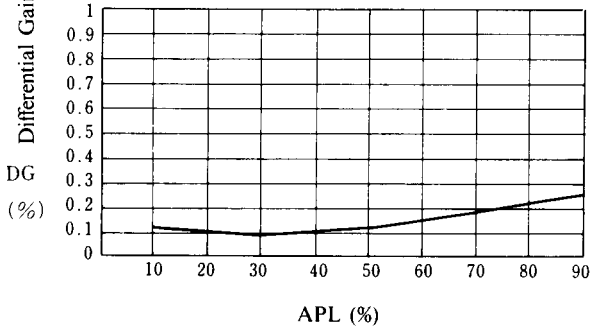

Differential Phase vs. APL

(Ta = 25°C, V+ = 5V)

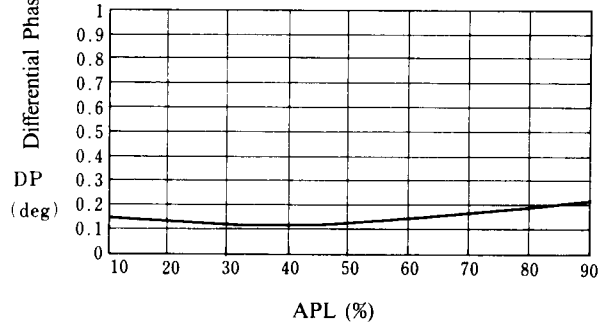

■ TYPICAL CHARACTERISTICS (Ta = +25°C)

Crosstalk vs. Operating Voltage

(Ta = 25°C)

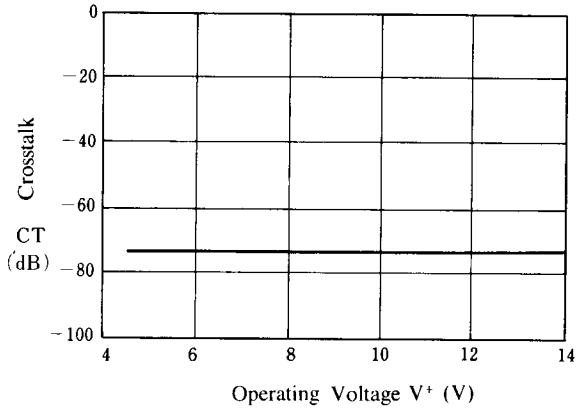

Crosstalk vs. Temperature

(V+ = 5V)

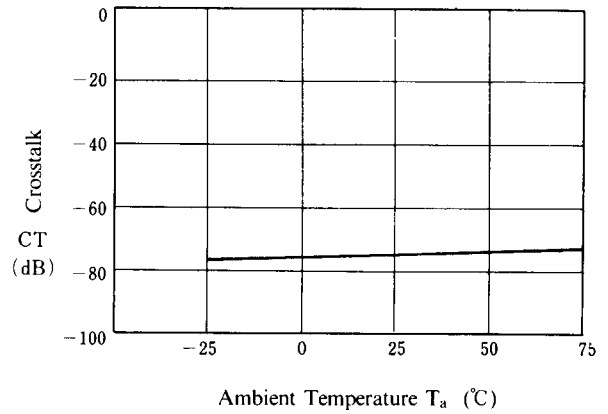

Crosstalk vs. Operating Voltage

(Ta = 25°C)

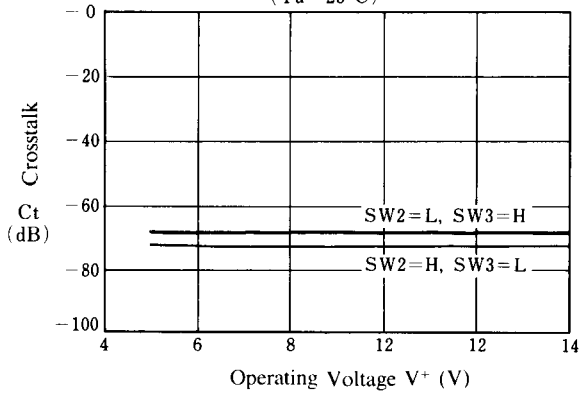

Crosstalk vs. Ambient Temperature

(V+ = 5V)

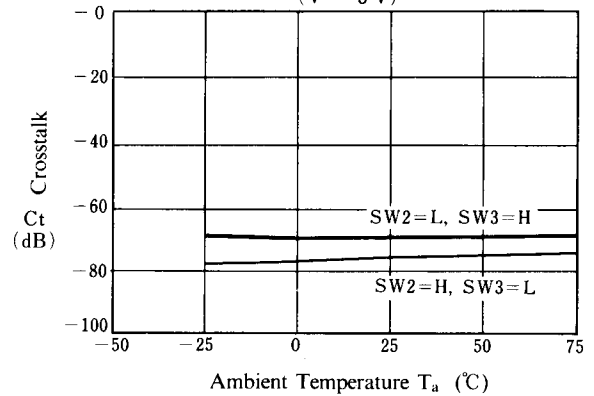

Crosstalk vs. Operating Voltage

(Ta = 25°C)

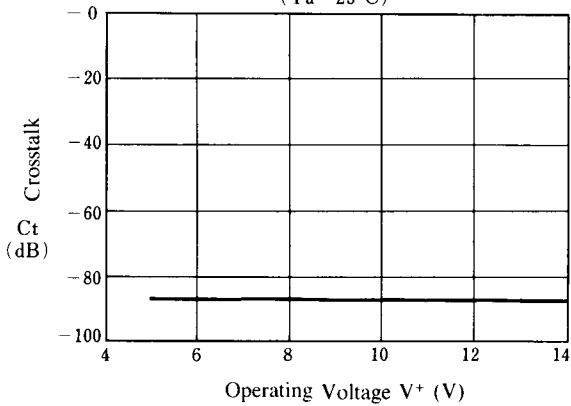

Crosstalk vs. Ambient Temperature

(V+ = 5V)

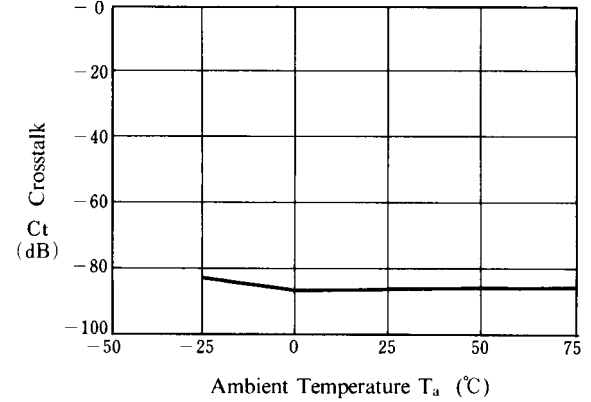

■ TYPICAL CHARACTERISTICS (T_a = +25°C)

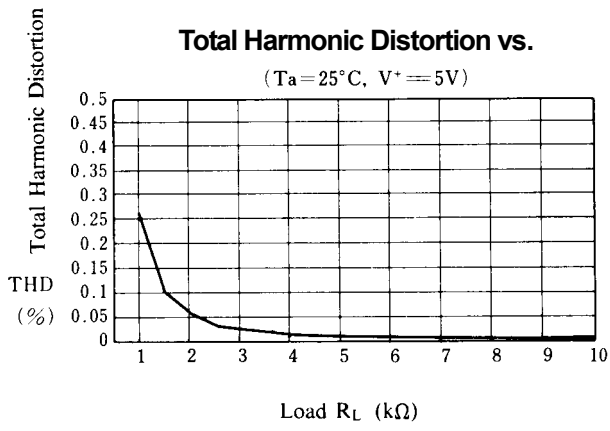

NJM2508

■ APPLICATION

This IC requires $1\text{M}\Omega$ resistance between INPUT and GND pin for clamp type input since the minute current causes an unstable pin voltage.

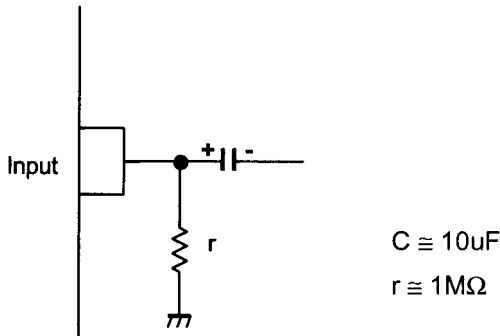

This IC requires $0.1\mu\text{F}$ capacitor between INPUT and GND, $1\text{M}\Omega$ resistance between INPUT and GND for clamp type input at mute mode.

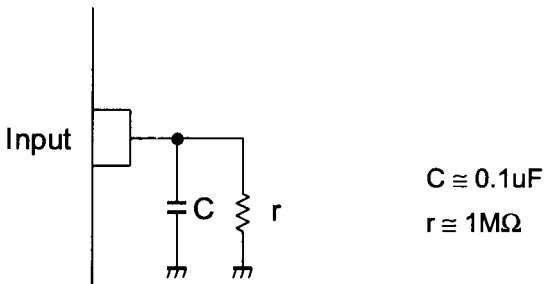

This IC requires $0.1\mu\text{F}$ capacitor between INPUT and GND for bias type input at mute mode.

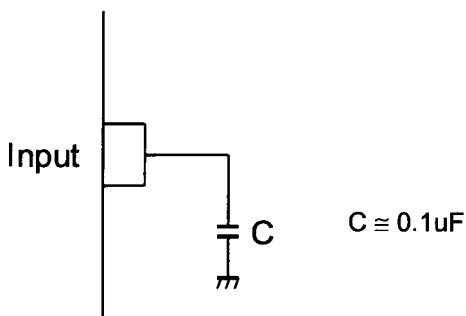

[CAUTION]
The specifications on this databook are only given for information, without any guarantee as regards either mistakes or omissions. The application circuits in this databook are described only to show representative usages of the product and not intended for the guarantee or permission of any right including the industrial rights.

Данный компонент на территории Российской Федерации

Вы можете приобрести в компании MosChip.

Для оперативного оформления запроса Вам необходимо перейти по данной ссылке:

<http://moschip.ru/get-element>

Вы можете разместить у нас заказ для любого Вашего проекта, будь то серийное производство или разработка единичного прибора.

В нашем ассортименте представлены ведущие мировые производители активных и пассивных электронных компонентов.

Нашей специализацией является поставка электронной компонентной базы двойного назначения, продукции таких производителей как XILINX, Intel (ex.ALTERA), Vicor, Microchip, Texas Instruments, Analog Devices, Mini-Circuits, Amphenol, Glenair.

Сотрудничество с глобальными дистрибьюторами электронных компонентов, предоставляет возможность заказывать и получать с международных складов практически любой перечень компонентов в оптимальные для Вас сроки.

На всех этапах разработки и производства наши партнеры могут получить квалифицированную поддержку опытных инженеров.

Система менеджмента качества компании отвечает требованиям в соответствии с ГОСТ Р ИСО 9001, ГОСТ РВ 0015-002 и ЭС РД 009

Офис по работе с юридическими лицами:

105318, г.Москва, ул.Щербаковская д.3, офис 1107, 1118, ДЦ «Щербаковский»

Телефон: +7 495 668-12-70 (многоканальный)

Факс: +7 495 668-12-70 (доб.304)

E-mail: info@moschip.ru

Skype отдела продаж:

moschip.ru

moschip.ru_4

moschip.ru_6

moschip.ru_9