

Specification

Patent Pending

- Part No. : SWDP.2458.15.4.A.02
- Product Name : 5dBi 15mm Embedded 2.4/5.8GHz Dual-Band
Wi-Fi Ceramic Patch Antenna
- Feature : 15mm*15mm*4mm
2400MHz to 2500MHz
5150MHz to 5850Mhz
SMD Mount
Lightweight and Robust
Supports IEEE 802.11 Dual-Band Wi-Fi systems
Dual Linear Polarization for Higher Isolation
Tuned for 70x70mm Ground Plane
Automotive IATF16949 Production and Quality
Approved
RoHS compliant



1. Introduction

This revolutionary patent pending 5dBi, high efficiency, embedded ceramic patch antenna is designed for professional Wi-Fi dual-band IEEE 802.11 applications. This antenna is the smallest, highest gain off the shelf WiFi dual-band patch solution in the market today, enabling vastly improved coverage for applications in small devices where a directional antenna is applicable, where options until now have been limited to low gain chip antennas.

The SWDP.15's high gain and high efficiency performance is the perfect solution for directional dual-band Wi-Fi applications, which need long range, but require small compact embedded antennas. The much higher gain and efficiency of the SWDP.15 over smaller, less efficient, more omni-directional chip antennas (these typically have no more than 2dBi gain, 30% efficiencies) means it can deliver much longer range over a wide sector. At only 3.5 grams, it is lightweight yet robust. SMD mounting allows for high volume manufacturing applications.

Typical applications include:

- Access Points
- Tablets
- High definition, high throughput video streaming routers
- High data MIMO bandwidth routers
- Automotive
- Home and industrial in-wall Wi-Fi automation
- Drones/Quad-copters
- UAV
- Long range Wi-Fi remote control applications

The WDP patch antenna has two distinct linear polarizations on the 2.4 and 5.8GHz bands, increasing isolation between bands, thus reducing interference from neighbouring transmitters.

Custom tuning may be necessary on different ground-planes and in individual device environments. Custom tuned versions for different ground-planes and housing environments can be designed and supplied subject to NRE and a minimum order quantity. Contact your regional Taoglas office for support to integrate and test this antenna performance in your device.

2. Specification

Electrical			
Frequency	2400~2500MHz	4900~5500MHz	5500~5850MHz
Efficiency (%)	48.45	44.95	42.64
Average Gain(dBi)	-3.15	-3.47	-3.70
Peak Gain(dBi)	5.70	5.29	4.03
Impedance	50Ω		
Polarization	Linear		
Input Power	10W		
Mechanical			
Dimensions	15x15x4 mm		
Weight	3.5g		
Environmental			
Operating and Storage Temperature Range	-40°C to 85°C		
Humidity	Non-condensing 65°C 95% RH		

*All tests done on a 70*70mm ground plane

3. Antenna Characteristics

3.1 Return Loss

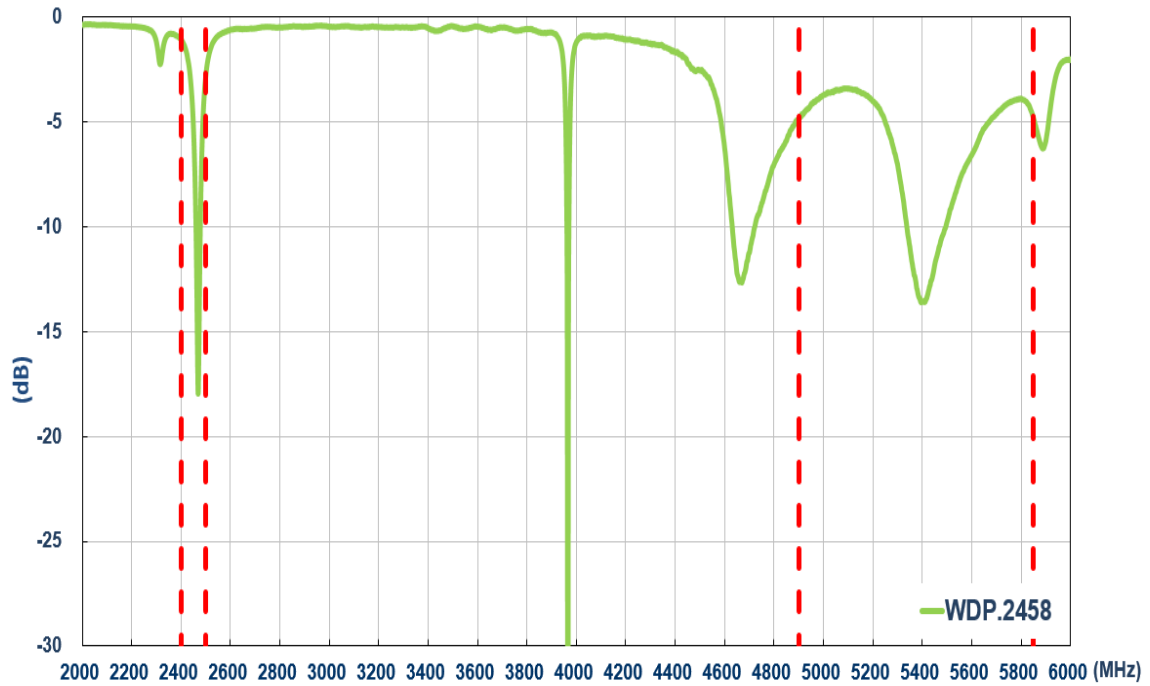

3.2 Efficiency

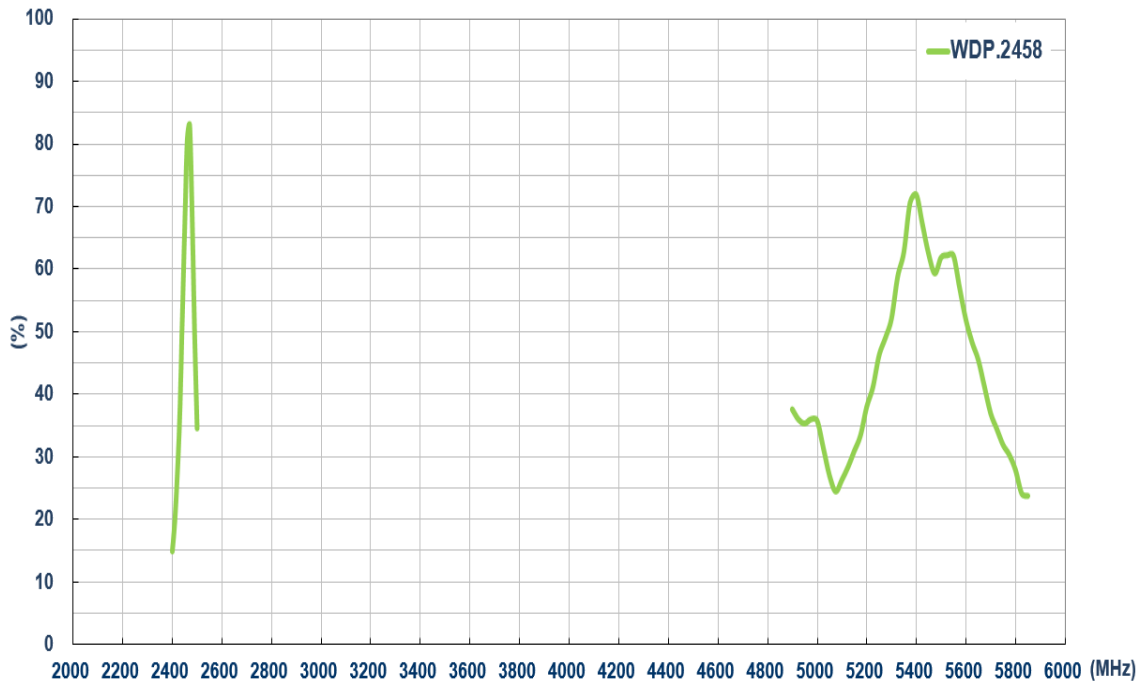

3.3 Peak Gain

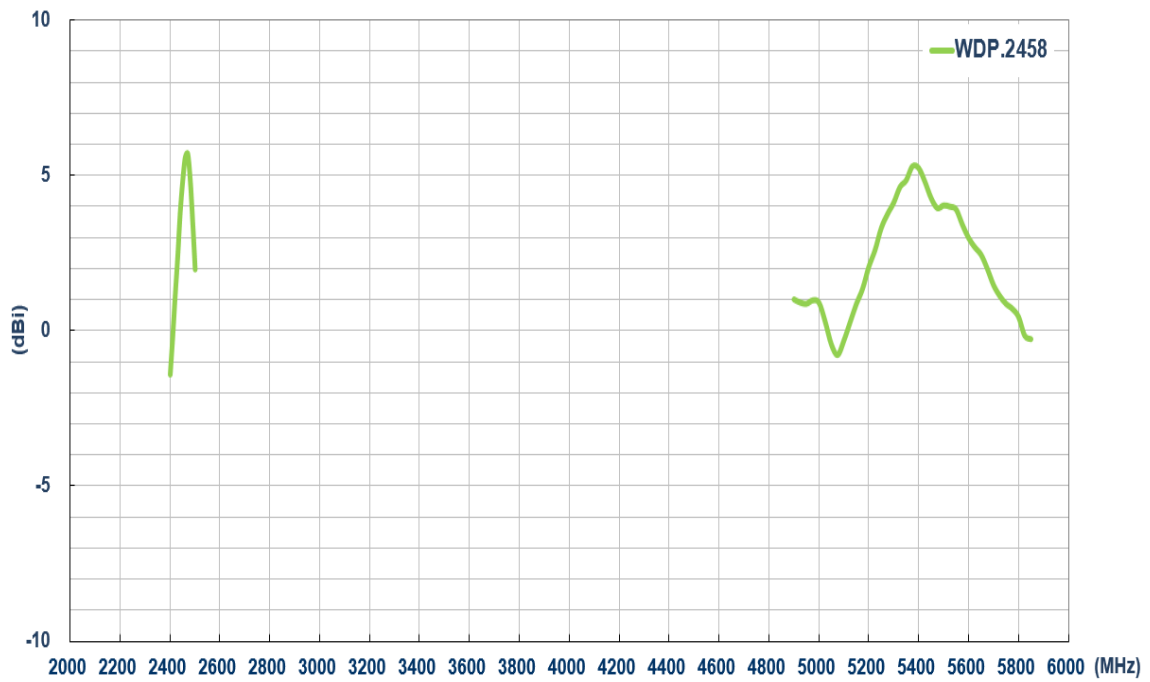

3.4 Average Gain

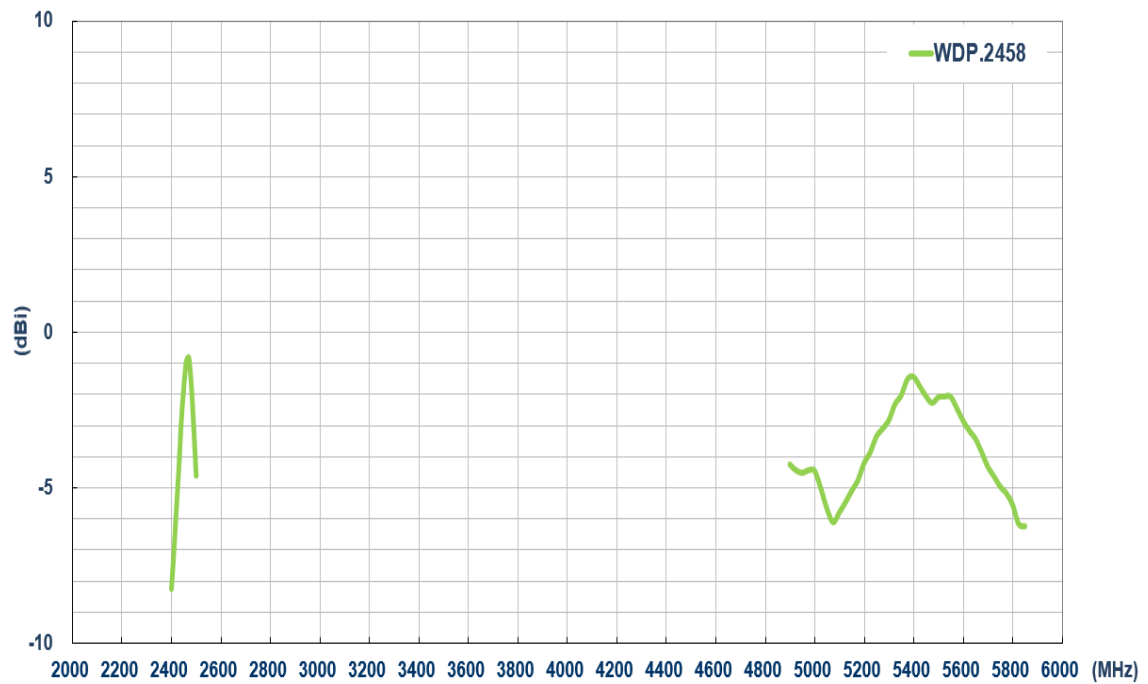

4 Antenna Radiation Patterns

4.1 Antenna setup (On the 70x70mm ground plane)

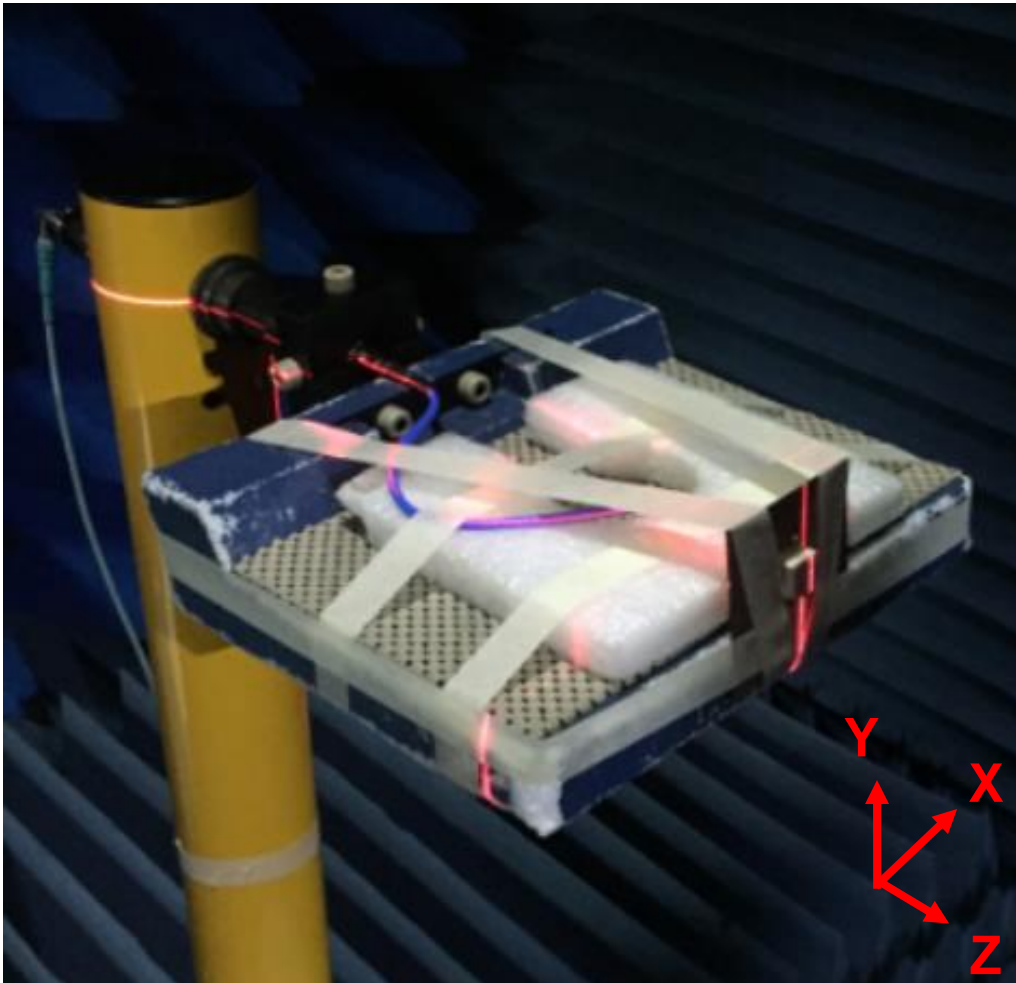

Antenna testing Setup in ETS Anechoic Chamber

4.2 2D Radiation Patterns (On the 70x70mm ground plane)

XY Plane

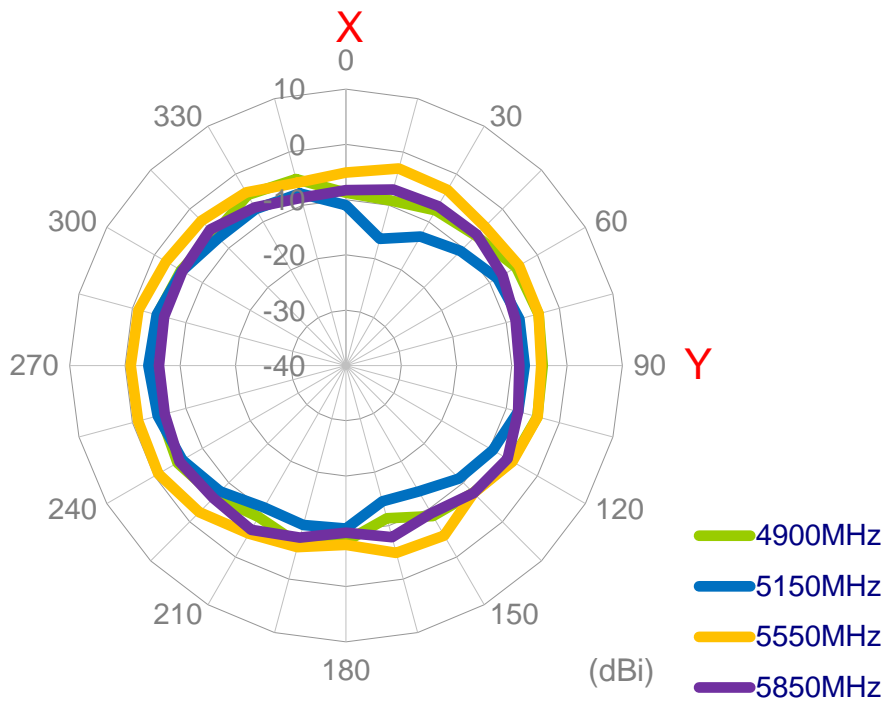
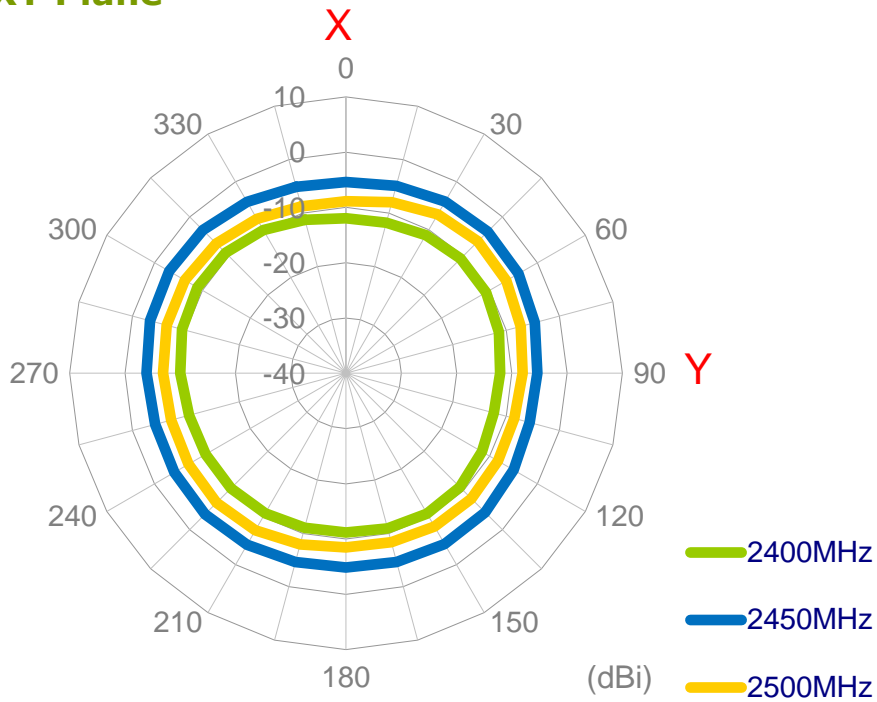

XZ Plane

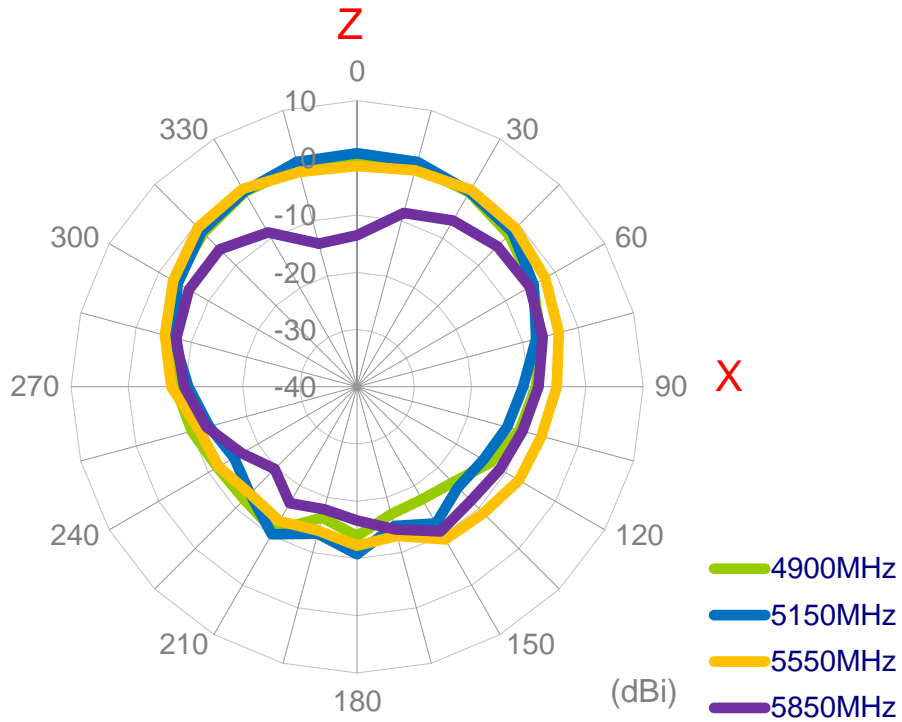
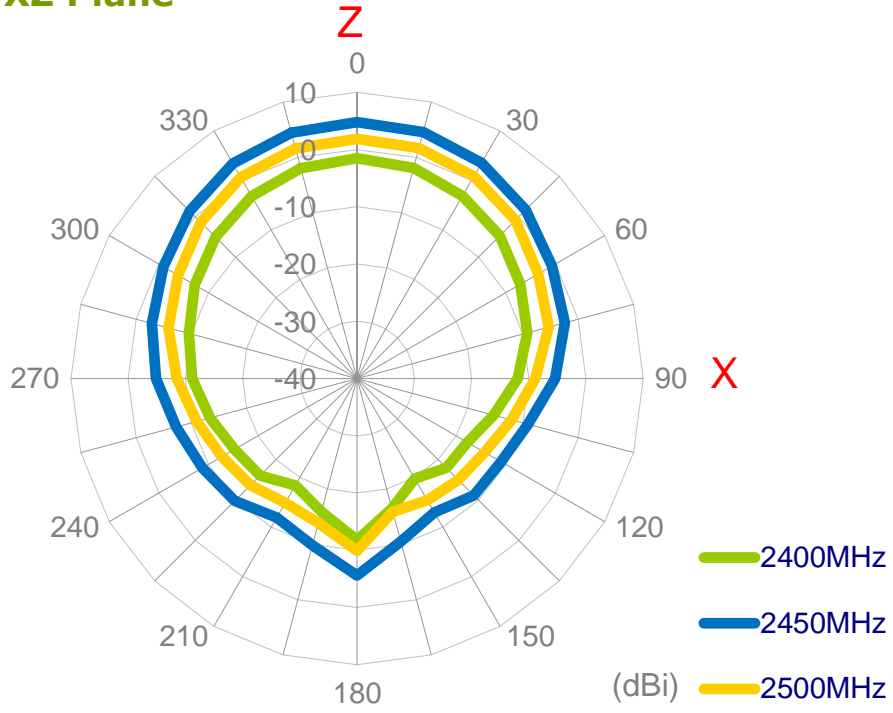

YZ Plane

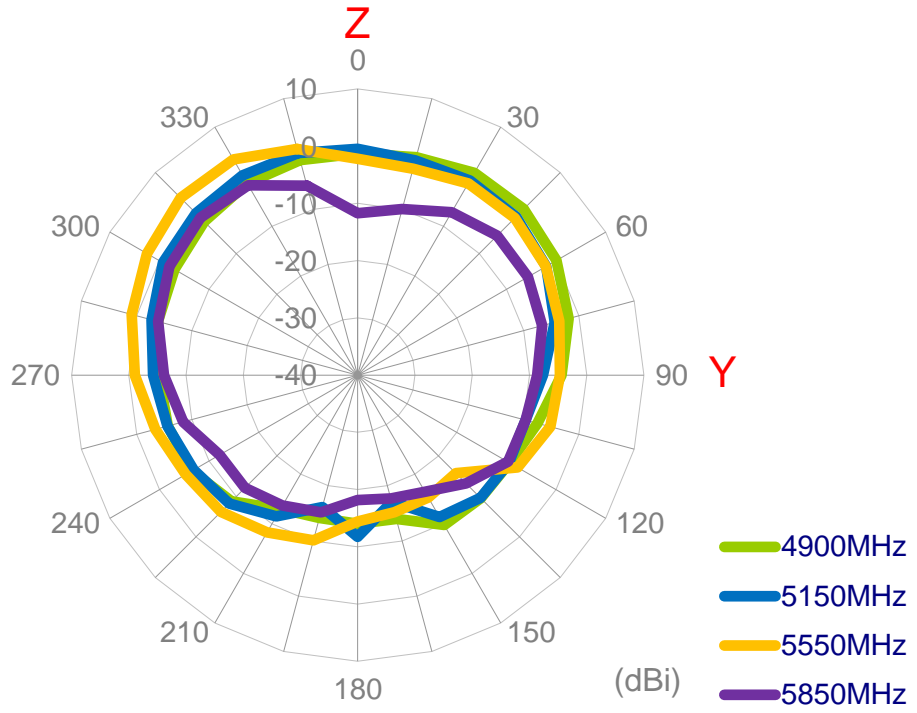
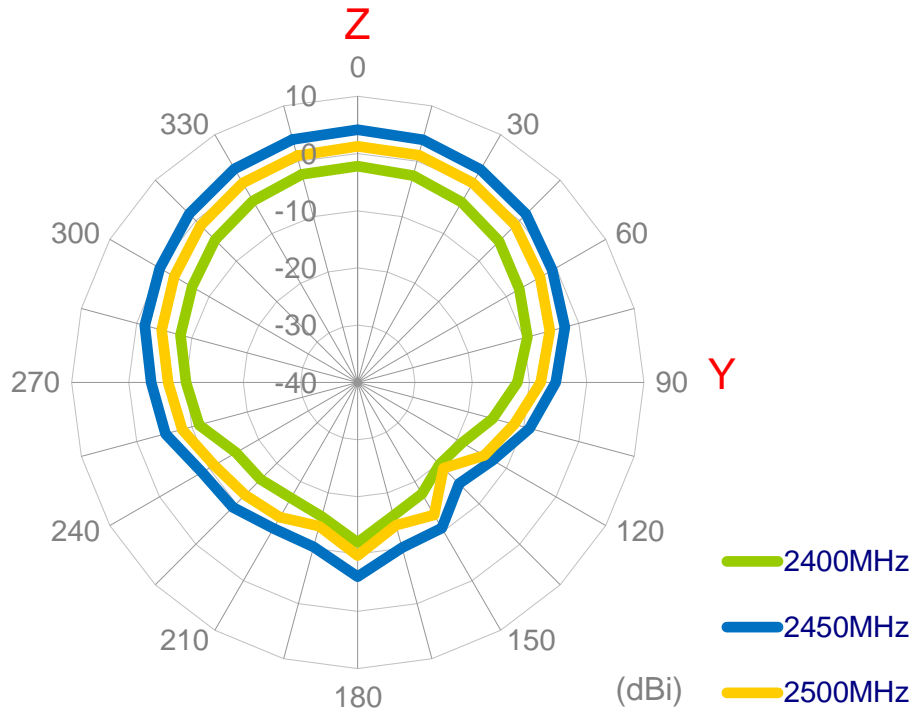

4.3 Antenna 3D Radiation Pattern (On the 70x70mm ground plane)

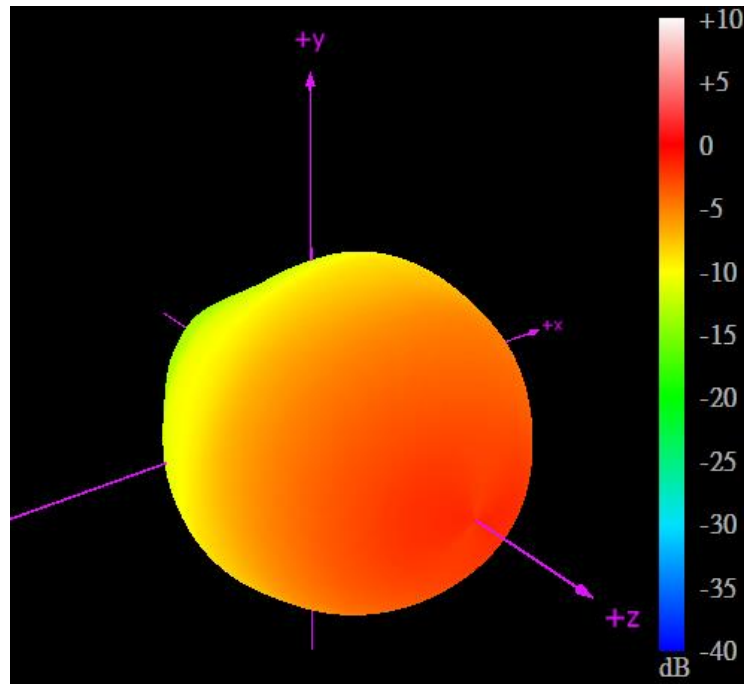

2400MHz

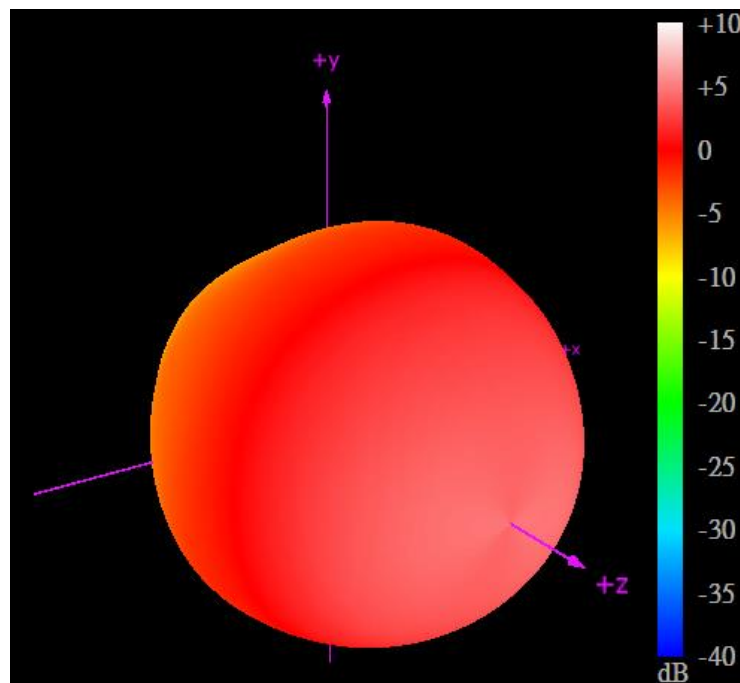

2450MHz

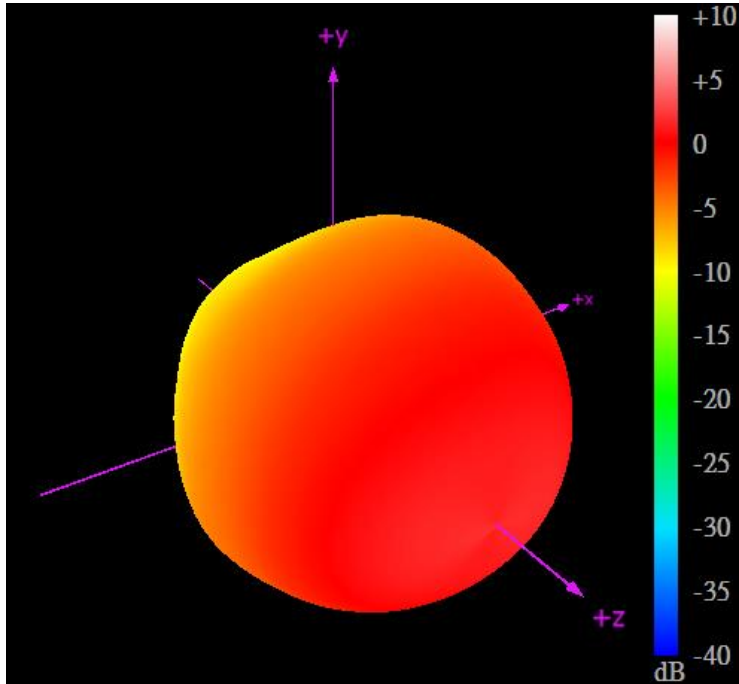

2500MHz

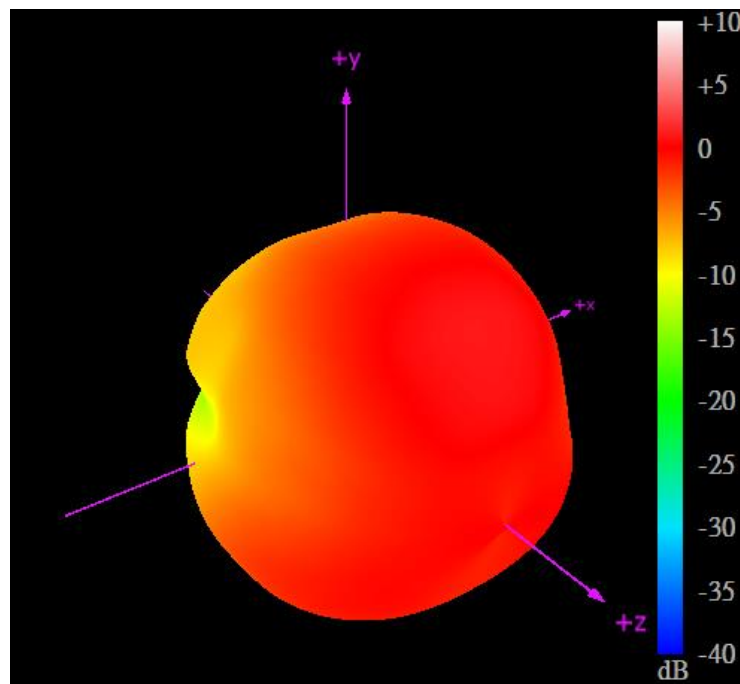

4900MHz

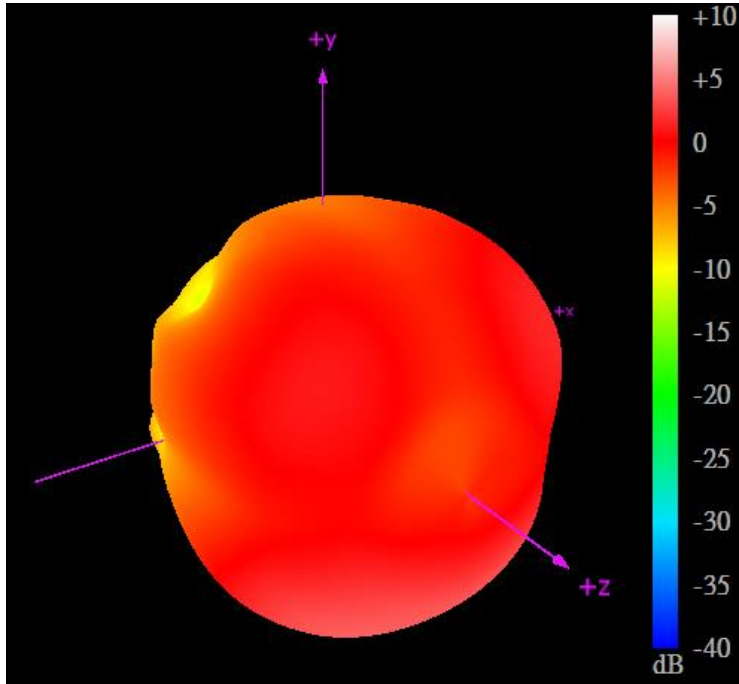



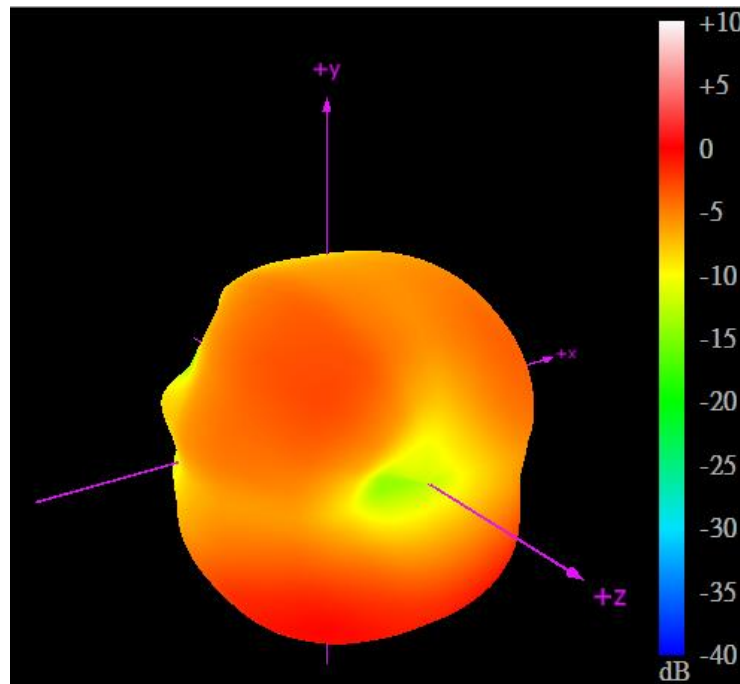





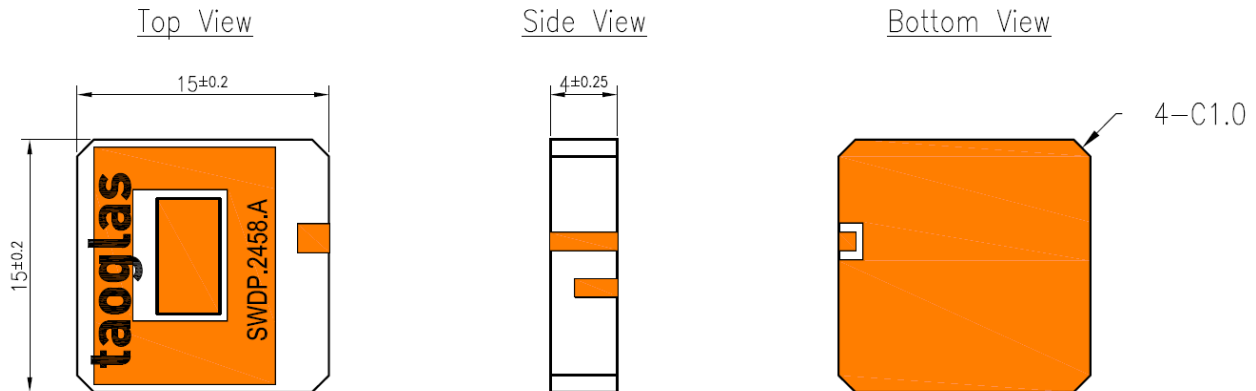

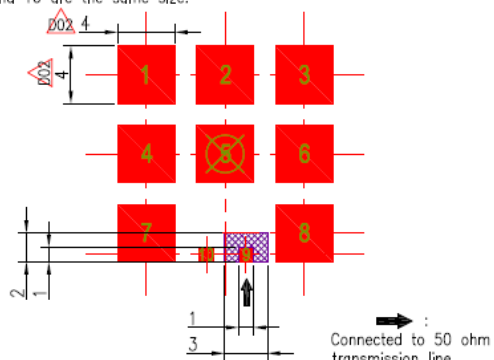
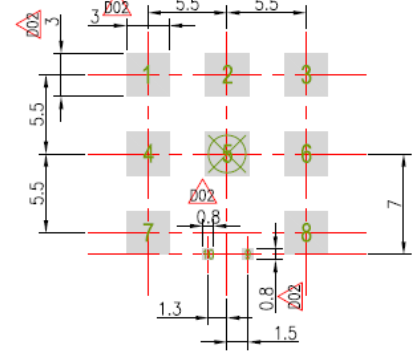
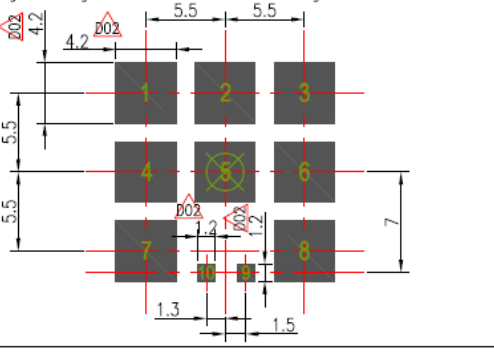
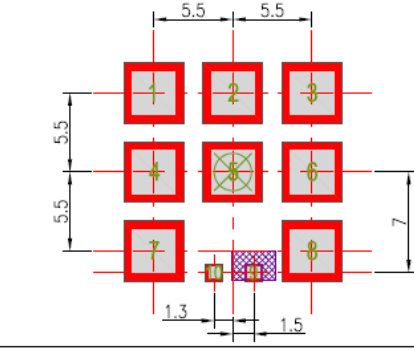





5550MHz



5850MHz

5 Mechanical Drawing (Unit: mm)



Foot Print																
<p>Top Copper</p> <p>Pads 9 should be connected to a 50 ohm transmission line. Pads 1, 2, 3, 4, 5, 6, 7, 8 and 10 should be connected to GND. Pads 9 and 10 are the same size.</p>  <p>Connected to 50 ohm transmission line.</p>	<p>Top Solder Paste</p> <p>Pads 1, 2, 3, 4, 5, 6, 7 and 8 are the same size. Pads 9 and 10 are the same size.</p> 															
<p>Top Solder Mask</p> <p>Pads 1, 2, 3, 4, 5, 6, 7 and 8 are the same size, This drawing is a negative of solder mask. Black regions are anti-mask.</p> 	<p>Composite Diagram</p> 															
<p>NOTE:</p> <table border="0"> <tr> <td>1. Ag Plated area</td> <td></td> <td>6. Copper keepout should extend through all PCB layers.</td> </tr> <tr> <td>2. Solder Mask area</td> <td></td> <td>7. Any vias in pads should be either filled or tented to prevent solder from wicking away from the pad during reflow.</td> </tr> <tr> <td>3. Copper area</td> <td></td> <td>8. The dimension tolerances should follow standard PCB manufacturing guidelines</td> </tr> <tr> <td>4. Paste area</td> <td></td> <td></td> </tr> <tr> <td>5. Copper Keepout Area</td> <td></td> <td></td> </tr> </table>		1. Ag Plated area		6. Copper keepout should extend through all PCB layers.	2. Solder Mask area		7. Any vias in pads should be either filled or tented to prevent solder from wicking away from the pad during reflow.	3. Copper area		8. The dimension tolerances should follow standard PCB manufacturing guidelines	4. Paste area			5. Copper Keepout Area		
1. Ag Plated area		6. Copper keepout should extend through all PCB layers.														
2. Solder Mask area		7. Any vias in pads should be either filled or tented to prevent solder from wicking away from the pad during reflow.														
3. Copper area		8. The dimension tolerances should follow standard PCB manufacturing guidelines														
4. Paste area																
5. Copper Keepout Area																

6 Packaging

500 pc SDWP.2458.15.4.A.02 per reel
 Dimensions - $\varnothing 330 \times 36.4 \text{mm}$

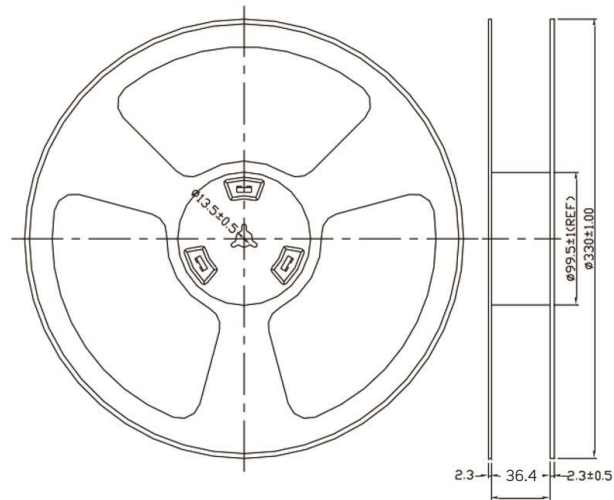

1 pc reel in small inner box
 Dimensions - $350 \times 340 \times 47 \text{mm}$

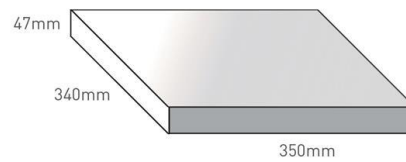

5 Reels / 2500 pcs in one carton
 Carton Dimensions - $370 \times 360 \times 275 \text{mm}$

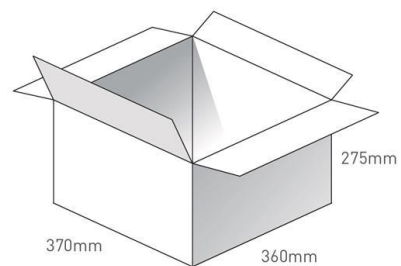

Taoglas makes no warranties based on the accuracy or completeness of the contents of this document and reserves the right to make changes to specifications and product descriptions at any time without notice. Taoglas reserves all rights to this document and the information contained herein.

Reproduction, use or disclosure to third parties without express permission is strictly prohibited.

Copyright © Taoglas Ltd.

Данный компонент на территории Российской Федерации

Вы можете приобрести в компании MosChip.

Для оперативного оформления запроса Вам необходимо перейти по данной ссылке:

<http://moschip.ru/get-element>

Вы можете разместить у нас заказ для любого Вашего проекта, будь то серийное производство или разработка единичного прибора.

В нашем ассортименте представлены ведущие мировые производители активных и пассивных электронных компонентов.

Нашей специализацией является поставка электронной компонентной базы двойного назначения, продукции таких производителей как XILINX, Intel (ex.ALTERA), Vicor, Microchip, Texas Instruments, Analog Devices, Mini-Circuits, Amphenol, Glenair.

Сотрудничество с глобальными дистрибьюторами электронных компонентов, предоставляет возможность заказывать и получать с международных складов практически любой перечень компонентов в оптимальные для Вас сроки.

На всех этапах разработки и производства наши партнеры могут получить квалифицированную поддержку опытных инженеров.

Система менеджмента качества компании отвечает требованиям в соответствии с ГОСТ Р ИСО 9001, ГОСТ РВ 0015-002 и ЭС РД 009

Офис по работе с юридическими лицами:

105318, г.Москва, ул.Щербаковская д.3, офис 1107, 1118, ДЦ «Щербаковский»

Телефон: +7 495 668-12-70 (многоканальный)

Факс: +7 495 668-12-70 (доб.304)

E-mail: info@moschip.ru

Skype отдела продаж:

moschip.ru

moschip.ru_4

moschip.ru_6

moschip.ru_9