

### FEATURES

- Low noise preamplifier (PrA)
- Voltage noise = 1.3 nV/ $\sqrt{\text{Hz}}$  typical
- Current noise = 2.4 pA/ $\sqrt{\text{Hz}}$  typical
- NF = 7 dB ( $R_S = R_{IN} = 50 \Omega$ )
- Single-ended input;  $V_{IN}$  maximum = 625 mV p-p
- Active input match
- Input SNR (noise bandwidth = 20 MHz) = 92 dB
- VGA
  - Differential output
  - $V_{OUT}$  maximum = 5 V p-p,  $R_L = 500 \Omega$  differential
  - Gain range (8 dB output gain step)
    - 10 dB to +38 dB—low gain mode
    - 2 dB to +46 dB—high gain mode
  - Accurate linear-in-dB gain control
- PrA + VGA performance
  - 3 dB bandwidth of 85 MHz
  - Excellent overload performance
  - Supply: 5 V
- Power consumption
  - 95 mW/channel (380 mW total)
  - 65 mW/channel (PrA off; 260 mW total)
- Power-down

### APPLICATIONS

- Medical imaging (ultrasound, gamma cameras)
- Sonar
- Test and measurement
- Precise, stable wideband gain control

### GENERAL DESCRIPTION

The AD8335 is a quad variable gain amplifier (VGA) with low noise preamplifier intended for cost and power sensitive applications. Each channel features a gain range of 48 dB, fully differential signal paths, active input preamplifier matching, and user-selectable maximum gains of 46 dB and 38 dB. Individual gain controls are provided for each channel.

The preamplifier (PrA) has a single-ended to differential gain of  $\times 8$  (18.06 dB) and accepts input signals  $\leq 625$  mV p-p. PrA noise is 1.2 nV/ $\sqrt{\text{Hz}}$  and the combined input referred voltage noise of the PrA and VGA is 1.3 nV/ $\sqrt{\text{Hz}}$  at maximum gain.

### FUNCTIONAL BLOCK DIAGRAM

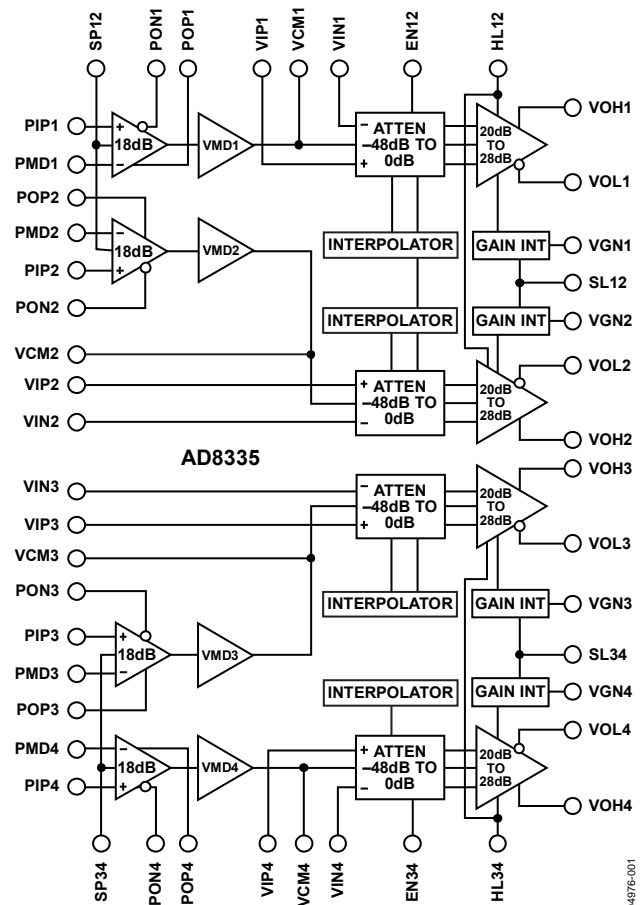

Figure 1.

Assuming a 20 MHz noise bandwidth (NBW), the Nyquist frequency for a 40 MHz ADC, the input SNR is 92 dB. The HLxx pin optimizes the output SNR for 10-bit and 12-bit ADCs with 1 V p-p or 2 V p-p full-scale (FS) inputs.

Channel 1 and Channel 2 are enabled through the EN12 pin, and Channel 3 and Channel 4 are enabled through the EN34 pin. For VGA only applications, the PrAs can be powered down, significantly reducing power consumption.

The AD8335 is available in a 64-lead lead frame chip scale package (9 mm  $\times$  9 mm) for the industrial temperature range of  $-40^\circ\text{C}$  to  $+85^\circ\text{C}$ .

#### Rev. B

Information furnished by Analog Devices is believed to be accurate and reliable. However, no responsibility is assumed by Analog Devices for its use, nor for any infringements of patents or other rights of third parties that may result from its use. Specifications subject to change without notice. No license is granted by implication or otherwise under any patent or patent rights of Analog Devices. Trademarks and registered trademarks are the property of their respective owners.

## TABLE OF CONTENTS

Features .....	1	VGA .....	18
Applications.....	1	Applications Information .....	20
Functional Block Diagram .....	1	Ultrasound .....	20
General Description .....	1	Basic Connections.....	21
Revision History .....	2	Preamp Connections .....	21
Specifications.....	3	Input Overdrive .....	22
Absolute Maximum Ratings.....	5	Logic Inputs.....	22
ESD Caution.....	5	Common-Mode Pins .....	22
Pin Configuration and Function Descriptions.....	6	Driving ADCs .....	22
Typical Performance Characteristics .....	7	Evaluation Board .....	23
Test Circuits.....	15	Board Layout.....	23
Theory of Operation .....	16	Outline Dimensions .....	28
Enable Summary .....	16	Ordering Guide .....	28
Preamp .....	17		

## REVISION HISTORY

### 2/12—Rev. A to Rev. B

Changes to Figure 1.....	1
Added Exposed Pad Notation to Figure 2 and Table 3.....	6
Changes to Figure 12 Caption.....	11
Deleted Measurement Setup Section .....	23
Changes to Figure 60 through Figure 68 .....	23
Deleted Table 7.....	27

### 8/08—Rev. 0 to Rev. A

Changes to Features Section.....	1
Changes to Table 1, Scale Factor Parameter.....	4
Changes to Theory of Operation Section.....	16
Changes to Figure 54.....	16
Changes to Equation 4 .....	18
Changes to Figure 58.....	21
Added Evaluation Board Section .....	23
Added Figure 60 to Figure 68.....	23
Updated Outline Dimensions .....	28
Changes to Ordering Guide .....	28

### 9/04—Revision 0: Initial Version

## SPECIFICATIONS

$V_S = 5\text{ V}$ ,  $T_A = 25^\circ\text{C}$ ,  $R_L = 500\ \Omega$ ,  $f = 5\text{ MHz}$ ,  $C_L = 10\text{ pF}$ , low gain range ( $-10\text{ dB}$  to  $+38\text{ dB}$ ),  $R_{FB} = 249\ \Omega$  (PrA  $R_{IN} = 50\ \Omega$ ) and signal voltage specified differential, per channel performance, dBm ( $50\ \Omega$ ), unless otherwise noted.

Table 1.

Parameter	Test Conditions/Comments	Min	Typ	Max	Unit
<b>PrA CHARACTERISTICS</b>					
Gain	Single-ended input to differential output		18		dB
	Single-ended input to single-ended output		12		dB
Input Voltage Range	PrA output limited to 5 V p-p differential		625		mV p-p
Input Resistance	$R_{FB} = 249\ \Omega$		50		$\Omega$
	$R_{FB} = 374\ \Omega$		75		$\Omega$
	$R_{FB} = 499\ \Omega$		100		$\Omega$
	$R_{FB} = \infty$ , low frequency value into PIPx		14.7		k $\Omega$
Input Capacitance	PIPx (Pin 2, Pin 15, Pin 18, Pin 63)		1.5		pF
-3 dB Small Signal Bandwidth	With $R_{FB} = 249\ \Omega$		110		MHz
Input Voltage Noise	$R_S = 0\ \Omega$ , $R_{FB} = \infty$		1.15		nV/ $\sqrt{\text{Hz}}$
Input Current Noise			2.4		pA/ $\sqrt{\text{Hz}}$
Noise Figure					
Active Termination Match	$R_S = R_{IN} = 50\ \Omega$ , $R_{FB} = 249\ \Omega$		7		dB
Unterminated	$R_S = 50\ \Omega$ , $R_{FB} = \infty$		4.4		dB
<b>PrA + VGA CHARACTERISTICS</b>					
-3 dB Small Signal Bandwidth	Unterminated: $R_S = 50\ \Omega$ , $R_{FB} = \infty$		70		MHz
	Matched: $R_S = R_{IN} = 50\ \Omega$		85		MHz
Slew Rate	Low gain, $V_{GN} = 3\text{ V}$ , $V_{OUT} = 2\text{ V p-p}$		250		V/ $\mu\text{s}$
	High gain, $V_{GN} = 3\text{ V}$ , $V_{OUT} = 2\text{ V p-p}$		350		V/ $\mu\text{s}$
Input Voltage Noise	$V_{GNx}$ pins = 3 V, $R_S = 0\ \Omega$ , $R_{FB} = \infty$		1.3		nV/ $\sqrt{\text{Hz}}$
Noise Figure	$V_{GNx}$ pins = 3 V, $f = 1\text{ MHz}$ to $10\text{ MHz}$				
Active Termination Match	$R_S = R_{IN} = 50\ \Omega$		7		dB
	$R_S = R_{IN} = 100\ \Omega$		4.5		dB
Unterminated	$R_S = 50\ \Omega$ , $R_{FB} = \infty$		5.0		dB
	$R_S = 500\ \Omega$ , $R_{FB} = \infty$		1.3		dB
Output Referred Noise	Low gain; $V_{GN} < 2\text{ V}$		33		nV/ $\sqrt{\text{Hz}}$
	High gain; $V_{GN} < 2\text{ V}$		80		nV/ $\sqrt{\text{Hz}}$
Peak Output Voltage	Differential, $R_L \geq 500\ \Omega$		5		V p-p
Output Resistance	$f < 1\text{ MHz}$ , $V_{OHx}$ , $V_{OLx}$ pins		1.2		$\Omega$
Common-Mode Level	Set to midsupply for PrA and VGA		$V_S/2$		V
Output Offset Voltage					
Differential	Between $V_{OHx}$ pins and $V_{OLx}$ pins, full gain range	-25	+5	+35	mV
Common-Mode	Between $V_{OHx}$ pins and $V_{CMx}$ pins, and between $V_{OLx}$ pins and $V_{CMx}$ pins	-20	+0	+20	mV
Harmonic Distortion	$V_{OUT} = 1\text{ V p-p}$ , low gain, $V_{GN} = 2\text{ V}$				
HD2	$f = 1\text{ MHz}$		-69		dBc
HD3	$f = 1\text{ MHz}$		-57		dBc
HD2	$f = 10\text{ MHz}$		-57		dBc
HD3	$f = 10\text{ MHz}$		-55		dBc
Harmonic Distortion	$V_{OUT} = 1\text{ V p-p}$ , high gain, $V_{GN} = 2\text{ V}$				
HD2	$f = 1\text{ MHz}$		-58		dBc
HD3	$f = 1\text{ MHz}$		-70		dBc
HD2	$f = 10\text{ MHz}$		-55		dBc
HD3	$f = 10\text{ MHz}$		-55		dBc
Output 1 dB Compression (OP1dB)	$V_{GN} = 3\text{ V}$		18		dBm
	$V_{GN} = 3\text{ V}$		8		dBV peak

Parameter	Test Conditions/Comments	Min	Typ	Max	Unit
Two-Tone IMD3 Distortion	$V_{OUT} = 1\text{ V p-p}$ , $V_{GN} = 3\text{ V}$ $f_1 = 1\text{ MHz}$ , $f_2 = 1.05\text{ MHz}$		-69		dBc
Output IP3 (OIP3)	$f_1 = 10\text{ MHz}$ , $f_2 = 10.05\text{ MHz}$ $V_{OUT} = 1\text{ V p-p}$ , $V_{GN} = 3\text{ V}$ $f = 1\text{ MHz}$		-65		dBc
Channel-to-Channel Crosstalk	$f = 10\text{ MHz}$		33		dBm
Overload Recovery	$V_{OUT} = 1\text{ V p-p}$ , $f = 1\text{ to }10\text{ MHz}$ PrA or VGA		31		dBm
Group Delay Variation	Full gain range, $f = 1\text{ MHz to }10\text{ MHz}$		-80		dBc
			10		ns
			3.0		ns
<b>GAIN CONTROL INTERFACE</b>	VGNx pins				
Normal Operating Range		0		3	V
Maximum Range	No gain foldover	0		$V_S$	V
Gain Range	Low gain mode; (HLxx pins = 0 V)		-10 to +38		dB
	High gain mode; (HLxx pins = $V_S$ )		-2 to +46		dB
Scale Factor	Nominal (Pin SL12 and Pin SL34 = 2.5 V)	19.1	20.1	21.1	dB/V
Bias Current			-0.3		$\mu\text{A}$
Response Bandwidth			5		MHz
Response Time	48 dB gain change		350		ns
<b>GAIN ACCURACY</b>	VGNx pins				
Absolute Gain Error	$0 \leq V_{GN} \leq 0.4\text{ V}$	1.25		7.5	dB
	$0.4 \leq V_{GN} \leq 2.6\text{ V}$ , $1\sigma$	-1.25	$\pm 0.2$	+1.25	dB
	$2.6 \leq V_{GN} \leq 3\text{ V}$	-7.5		-1.25	dB
Gain Law Conformance Over Temperature Intercept	$0.4 \leq V_{GN} \leq 2.6\text{ V}$ ; $-40^\circ\text{C} < T_A < +85^\circ\text{C}$ Low gain mode; PrA matched to $50\ \Omega$		$\pm 0.75$		dB
	High gain mode; PrA matched to $50\ \Omega$		-16.1		dB
Channel-to-Channel Matching	$0.4 \leq V_{GN} \leq 2.6\text{ V}$		-8.1		dB
			0.15		dB
<b>LOGIC LEVEL—HIGH/LOW, SHUTDOWN PREAMP, and ENABLE INTERFACES</b>	HLxx, SPxx, and ENxx pins				
Logic High		2.75		5	V
Logic Low		0		1	V
<b>BIAS CURRENT—HIGH/LOW, ENABLE</b>					
Logic High			80		$\mu\text{A}$
Logic Low			-12		$\mu\text{A}$
<b>INPUT RESISTANCE—HIGH/LOW, ENABLE</b>			50		k $\Omega$
<b>BIAS CURRENT—SHUTDOWN PREAMP</b>					
Logic High			20		$\mu\text{A}$
Logic Low			0		$\mu\text{A}$
<b>INPUT RESISTANCE—SHUTDOWN PREAMP</b>					
High/Low Response Time			500		k $\Omega$
Enable Response Time			0.6		$\mu\text{s}$
			100		$\mu\text{s}$
<b>POWER SUPPLY</b>	VPPx and VPVx pins				
Supply Voltage		4.5	5	5.5	V
Quiescent Current	Each channel—PrA and VGA enabled		19		mA
	Each channel—PrA disabled, VGA enabled		13		mA
	All channels enabled		76		mA
Over Temperature Quiescent Power	$-40^\circ\text{C} < T_A < +85^\circ\text{C}$ Each channel—PrA and VGA enabled	16	95	22.8	mA
	Each channel—PrA disabled, VGA enabled		65		mW
Disable Current	All channels disabled		0.8		mA
PSRR	$V_{GN} = 0\text{ V}$ , all bypass capacitors removed, 1 MHz		-60		dB

## ABSOLUTE MAXIMUM RATINGS

Table 2.

Parameter	Rating
Voltage	
Supply $V_S$	6 V
Preamp Input	$V_S$
VGA Inputs	$V_S$
Enable, Shutdown Preamp, and High/Low Interfaces	$V_S$
Gain	$V_S$
Power Dissipation (4-Layer JEDEC Board (2s2p))	2.46 W
$\theta_{JA}$	26.4°C/W
$\theta_{JC}$	6.8°C/W
Operating Temperature Range	−40°C to +85°C
Storage Temperature Range	−65°C to +150°C
Lead Temperature (Soldering 60 sec)	300°C

Stresses above those listed under Absolute Maximum Ratings may cause permanent damage to the device. This is a stress rating only; functional operation of the device at these or any other conditions above those indicated in the operational section of this specification is not implied. Exposure to absolute maximum rating conditions for extended periods may affect device reliability.

### ESD CAUTION



**ESD (electrostatic discharge) sensitive device.** Charged devices and circuit boards can discharge without detection. Although this product features patented or proprietary protection circuitry, damage may occur on devices subjected to high energy ESD. Therefore, proper ESD precautions should be taken to avoid performance degradation or loss of functionality.

# PIN CONFIGURATION AND FUNCTION DESCRIPTIONS



NOTES  
 1. THE EXPOSED PADDLE MUST BE SOLDERED TO THE PCB GROUND TO ENSURE PROPER HEAT DISSIPATION, NOISE, AND MECHANICAL STRENGTH BENEFITS.

Figure 2. Pin Configuration

Table 3. Pin Function Descriptions

Pin No.	Mnemonic	Description	Pin No.	Mnemonic	Description
1	PMD2	Preamp Input Common—CH2	35	VOL4	VGA Output Negative—CH4
2	PIP2	Preamp Input—CH2	36	VPV4	Positive Supply VGA—CH4
3	VPP2	Positive Supply Preamp—CH2	37	VPV3	Positive Supply VGA—CH3
4	PON2	Preamp Output Negative—CH2	38	VOL3	VGA Output Negative—CH3
5	POP2	Preamp Output Positive—CH2	39	VOH3	VGA Output Positive—CH3
6	VIP2	VGA Input Positive—CH2	40	GND3	Ground VGA—CH3
7	VIN2	VGA Input Negative—CH2	41	GND2	Ground VGA—CH2
8	COM2	Ground Preamp—CH2	42	VOH2	VGA Output Positive—CH2
9	COM3	Ground Preamp—CH3	43	VOL2	VGA Output Negative—CH2
10	VIN3	VGA Input Negative—CH3	44	VPV2	Positive Supply VGA—CH2
11	VIP3	VGA Input Positive—CH3	45	VPV1	Positive Supply VGA—CH1
12	POP3	Preamp Output Positive—CH3	46	VOL1	VGA Output Negative—CH1
13	PON3	Preamp Output Negative—CH3	47	VOH1	VGA Output Positive—CH1
14	VPP3	Positive Supply Preamp—CH3	48	GND1	Ground VGA—CH1
15	PIP3	Preamp Input—CH3	49	HL12	High/Low Pin—CH1 and CH2
16	PMD3	Preamp Input Common—CH3	50	SL12	Slope Decoupling Pin—CH1 and CH2
17	PMD4	Preamp Input Common—CH4	51	SP12	Shutdown—Preamp 1 and Preamp 2
18	PIP4	Preamp Input—CH4	52	EN12	Enable—CH1 and CH2
19	VPP4	Positive Supply Preamp—CH4	53	VCM2	Common-Mode Decoupling Pin—CH2
20	PON4	Preamp Output Negative—CH4	54	VGN2	Gain Control—CH2
21	POP4	Preamp Output Positive—CH4	55	VCM1	Common-Mode Decoupling Pin—CH1
22	VIP4	VGA Input Positive—CH4	56	VGN1	Gain Control—CH1
23	VIN4	VGA Input Negative—CH4	57	COM1	Ground Preamp—CH1
24	COM4	Ground Preamp—CH4	58	VIN1	VGA Input Negative—CH1
25	VGN4	Gain Control—CH4	59	VIP1	VGA Input Positive—CH1
26	VCM4	Common-Mode Decoupling Pin—CH4	60	POP1	Preamp Output Positive—CH1
27	VGN3	Gain Control—CH3	61	PON1	Preamp Output Negative—CH1
28	VCM3	Common-Mode Decoupling Pin—CH3	62	VPP1	Positive Supply Preamp—CH1
29	EN34	Enable—CH3 and CH4	63	PIP1	Preamp Input—CH1
30	SP34	Shutdown—Preamp 3 and Preamp 4	64	PMD1	Preamp Input Common—CH1
31	SL34	Slope Decoupling Pin—CH3 and CH4		EPAD	The exposed paddle must be soldered to the PCB ground to ensure proper heat dissipation, noise, and mechanical strength benefits.
32	HL34	High/Low Pin—CH3 and CH4			
33	GND4	Ground VGA—CH4			
34	VOH4	VGA Output Positive—CH4			

# TYPICAL PERFORMANCE CHARACTERISTICS

$V_S = 5\text{ V}$ ,  $T_A = 25^\circ\text{C}$ ,  $R_L = 500\ \Omega$ ,  $f = 5\text{ MHz}$ ,  $C_L = 10\text{ pF}$ , low gain range ( $-10\text{ dB}$  to  $+38\text{ dB}$ ),  $R_{FB} = 249\ \Omega$  ( $\text{PrA } R_{IN} = 50\ \Omega$ ) and signal voltage specified differential, per channel performance, unless otherwise noted.

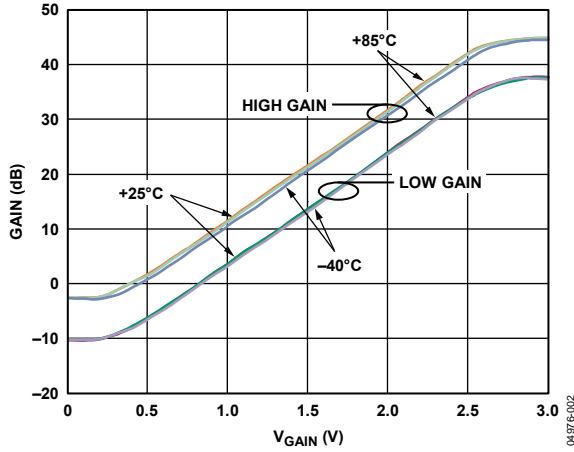

Figure 3. Gain vs.  $V_{GAIN}$  at Three Temperatures (See Figure 49)

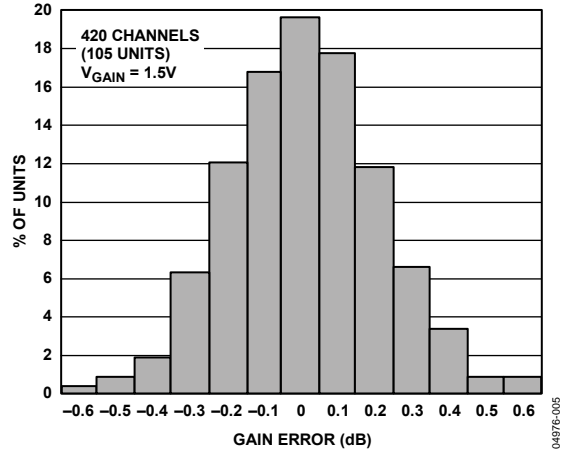

Figure 6. Gain Error Histogram



Figure 4. Gain Error vs.  $V_{GAIN}$  at Three Temperatures (See Figure 49)



Figure 7. Gain Match Histogram for  $V_{GAIN} = 1\text{ V}$  and  $2\text{ V}$



Figure 5. Gain Error vs.  $V_{GAIN}$  at Various Frequencies (See Figure 49)



Figure 8. Gain Scaling Factor Histogram for  $0.5\text{ V} < V_{GAIN} < 2.5\text{ V}$

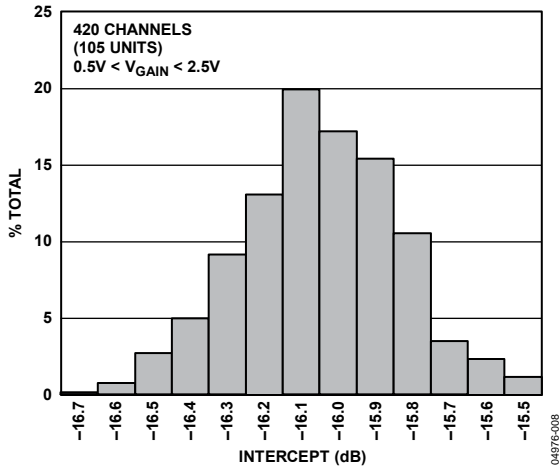

Figure 9. Intercept Histogram



Figure 12. Preamp Frequency Response for a Terminated and unterminated 50 Ω Source (See Figure 49)

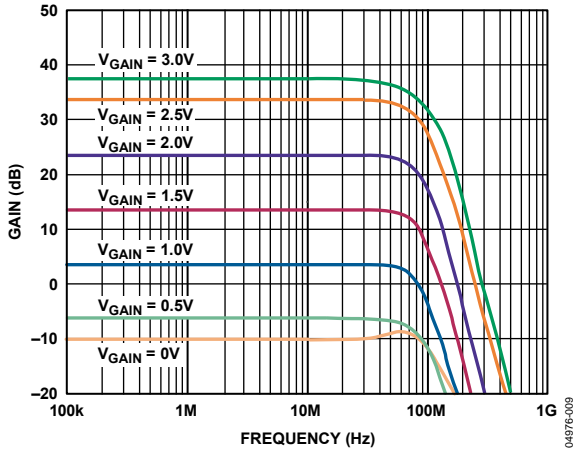

Figure 10. Frequency Response for Various Values of  $V_{GAIN}$  (See Figure 49)

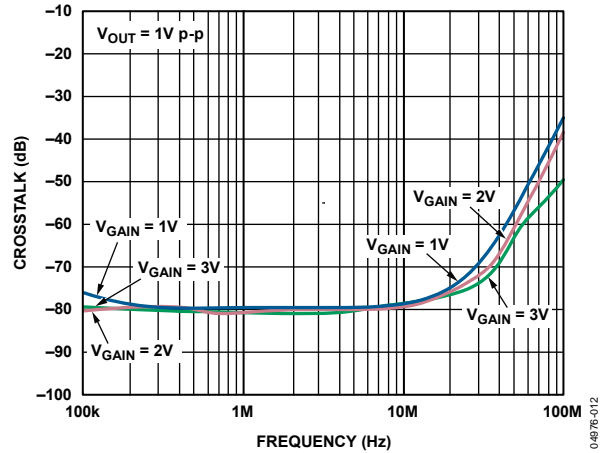

Figure 13. Channel-to-Channel Crosstalk vs. Frequency for Various Values of  $V_{GAIN}$

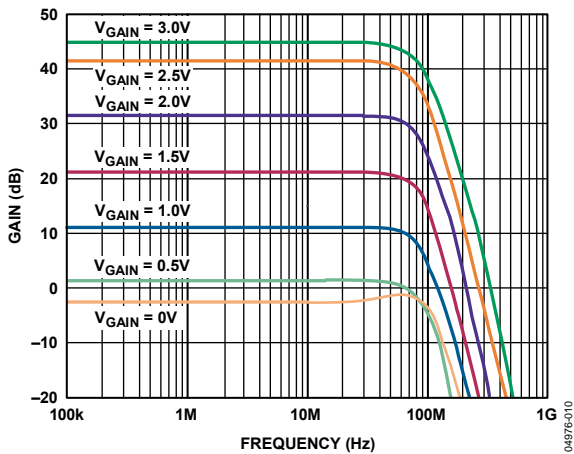

Figure 11. Frequency Response vs. Frequency for Various Values of  $V_{GAIN}$ ,  $HL_{xx}$  = High (See Figure 49)

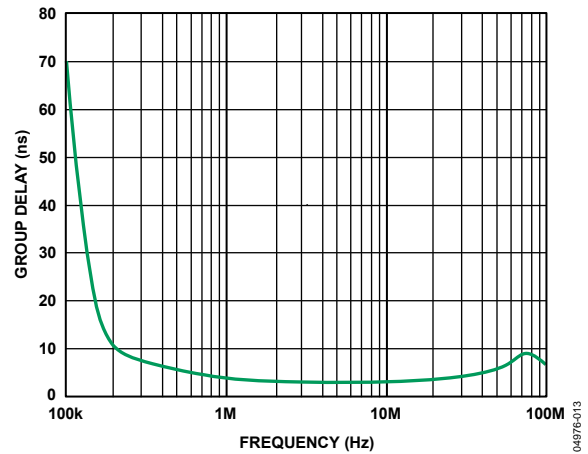

Figure 14. Group Delay vs. Frequency





Figure 15. Differential Output Offset Voltage vs.  $V_{GAIN}$  at Three Temperatures



Figure 18. Preamp Input Resistance vs. Frequency for Various Values of  $R_{FB}$

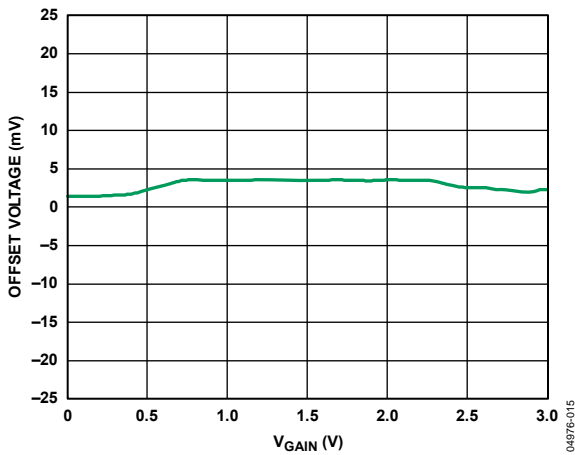

Figure 16. Absolute Offset vs.  $V_{GAIN}$  at  $VOH_x$  and  $VOL_x$  Pins Relative to  $VCM_x$  Pins



Figure 19. Smith Chart  $S_{11}$  vs. Frequency, 100 kHz to 1 GHz

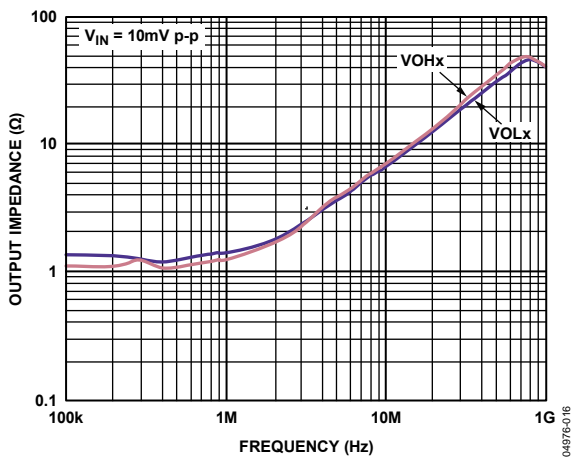

Figure 17. Output Resistance at  $VOH_x$  and  $VOL_x$  Pins vs. Frequency



Figure 20. Output Referred Noise vs.  $V_{GAIN}$  (See Figure 50)



Figure 21. Short-Circuit Input Referred Noise vs. Frequency at Maximum Gain (See Figure 50)



Figure 24. Noise Figure vs.  $V_{GAIN}$  for  $R_S = R_{IN} = 50 \Omega$

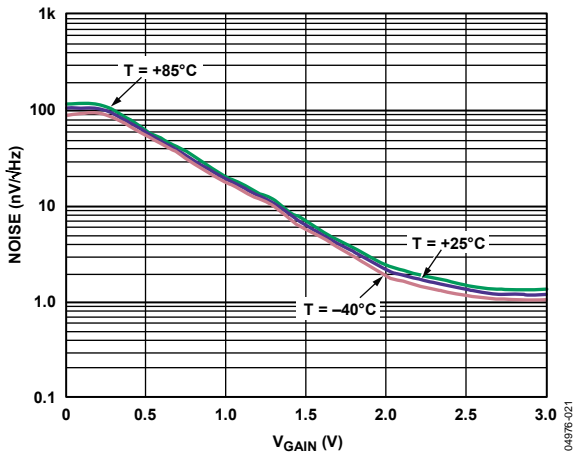

Figure 22. Input Referred Noise vs.  $V_{GAIN}$  at Three Temperatures (See Figure 50)



Figure 25. Harmonic Distortion vs.  $R_{LOAD}$  (See Figure 53)

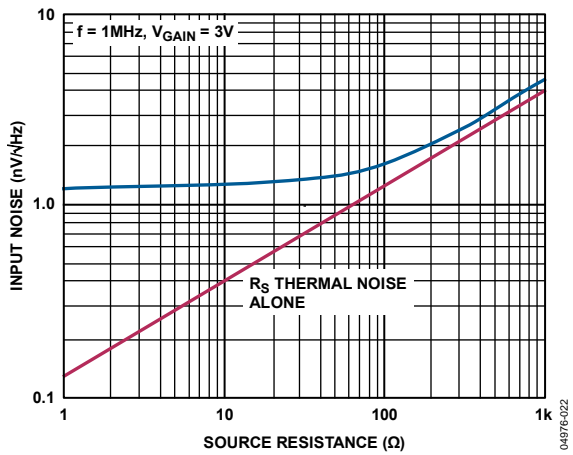

Figure 23. Input Referred Noise vs.  $R_S$



Figure 26. Harmonic Distortion vs.  $C_{LOAD}$  (See Figure 53)

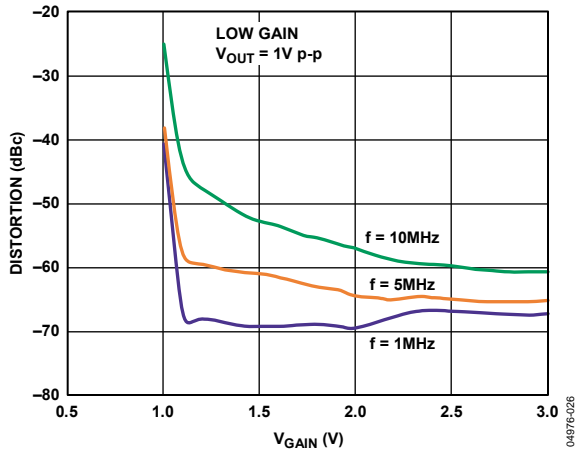

Figure 27. HD2 vs.  $V_{GAIN}$  at Three Frequencies, Low Gain (See Figure 53)



Figure 30. HD3 vs.  $V_{GAIN}$  at Three Frequencies, High Gain (See Figure 53)

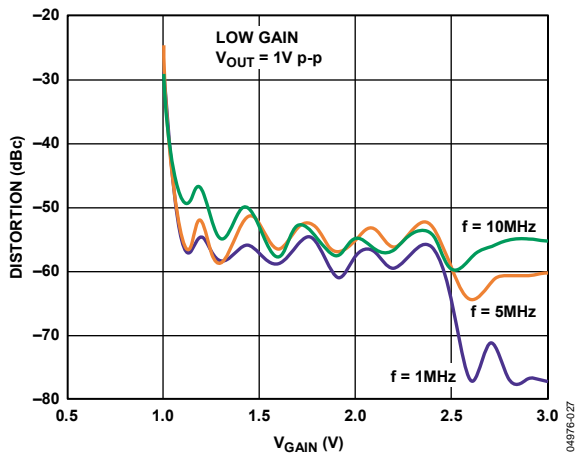

Figure 28. HD3 vs.  $V_{GAIN}$  at Three Frequencies, Low Gain (See Figure 53)

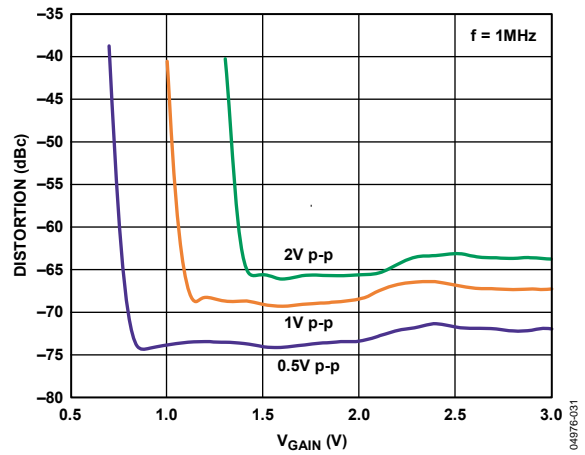

Figure 31. HD2 vs.  $V_{GAIN}$  at Three Output Voltages, Low Gain (See Figure 53)

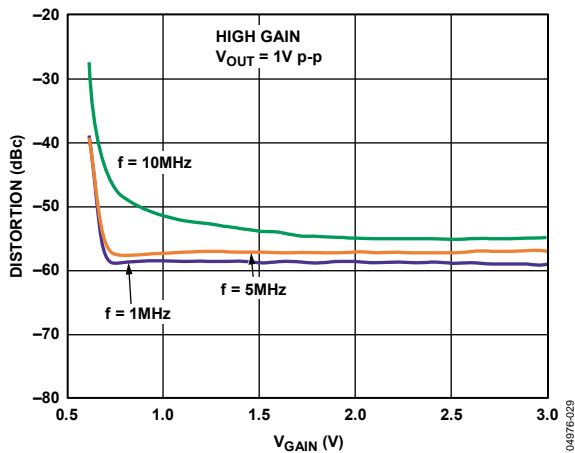

Figure 29. HD2 vs.  $V_{GAIN}$  at Three Frequencies, High Gain (See Figure 53)

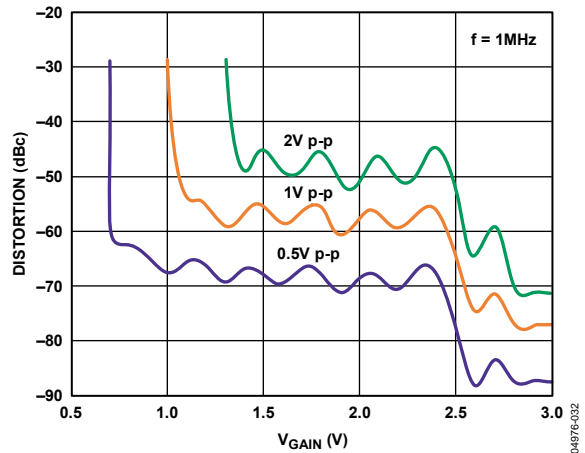

Figure 32. HD3 vs.  $V_{GAIN}$ , at Three Output Voltages, Low Gain (See Figure 53)

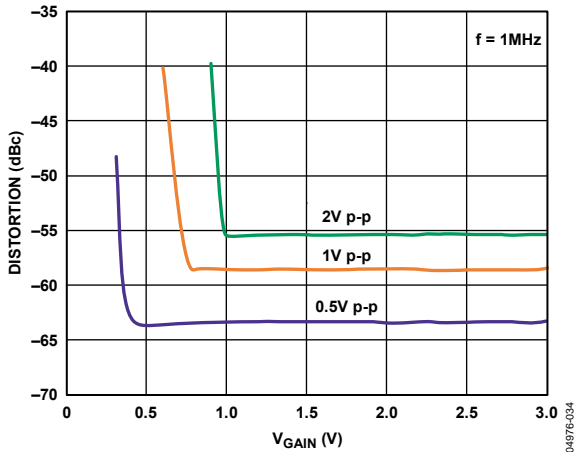

Figure 33. HD2 vs.  $V_{GAIN}$  at Three Output Voltages, High Gain,  $f = 1$  MHz (See Figure 53)

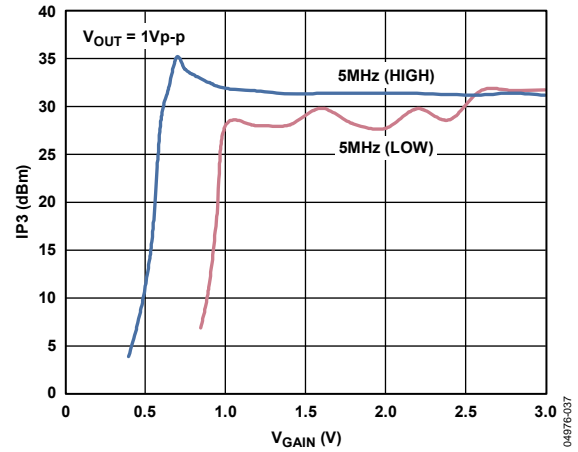

Figure 36. Output Referred IP3 (OIP3) vs.  $V_{GAIN}$

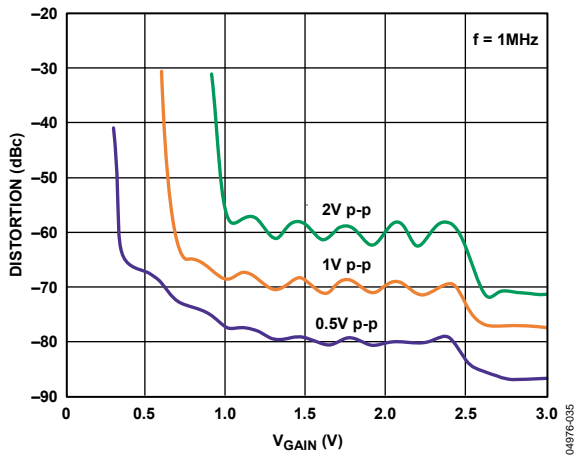

Figure 34. HD3 vs.  $V_{GAIN}$  at Three Output Voltages, High Gain (See Figure 53)

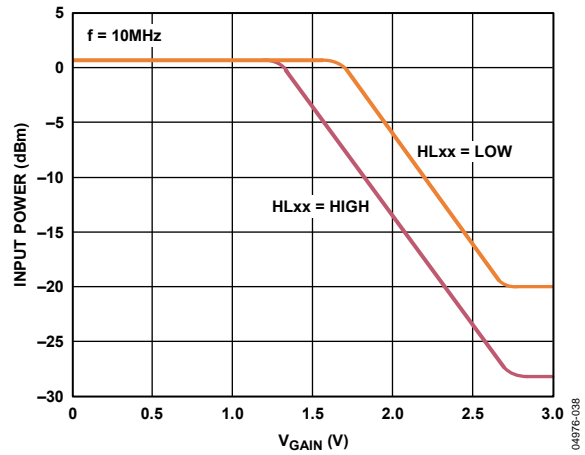

Figure 37. Input P1dB (IP1dB) vs.  $V_{GAIN}$

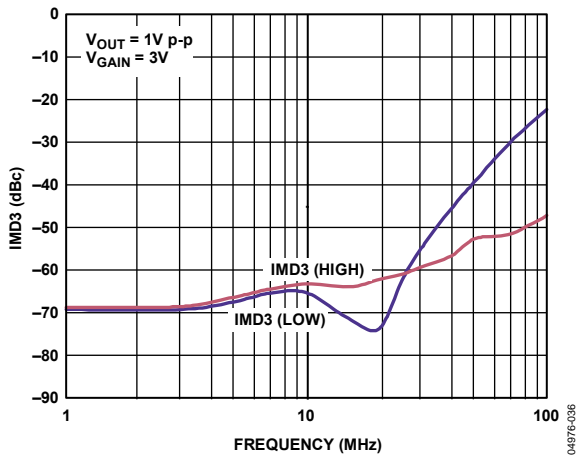

Figure 35. IMD3 vs. Frequency

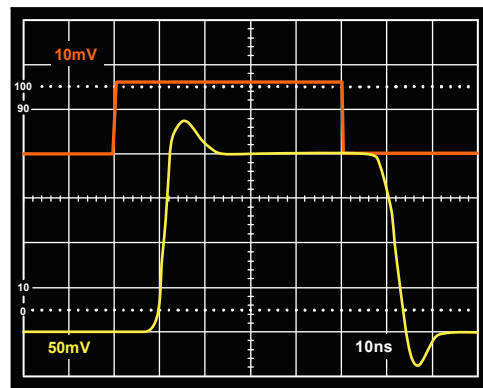

Figure 38. Small Signal Pulse Response, Low Gain (See Figure 51)



Figure 39. Large Signal Pulse Response, Low Gain (See Figure 51)

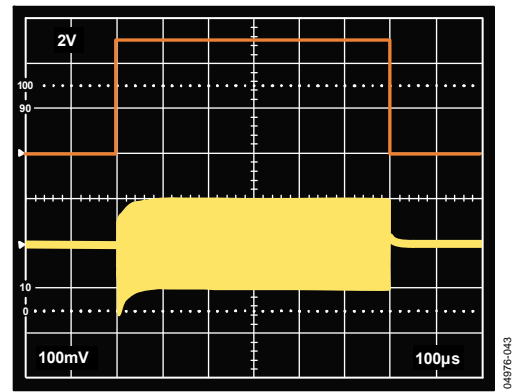

Figure 42. Small Signal Enable Response (See Figure 51)



Figure 40. Large Signal Pulse Response for Various Capacitive Loads,  $C_L = 0\text{ pF}, 10\text{ pF}, 20\text{ pF}, 47\text{ pF}$  Each Output (See Figure 51)

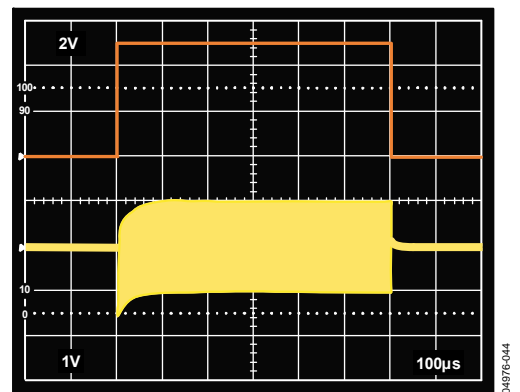

Figure 43. Large Signal Enable Response (See Figure 51)

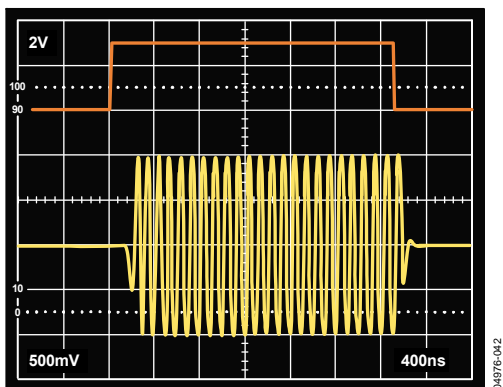

Figure 41. Gain Response,  $V_{GAIN}$  Stepped from  $0\text{ V}$  to  $3\text{ V}$ ,  $V_{OUT} = 2\text{ V p-p}$  (See Figure 51)

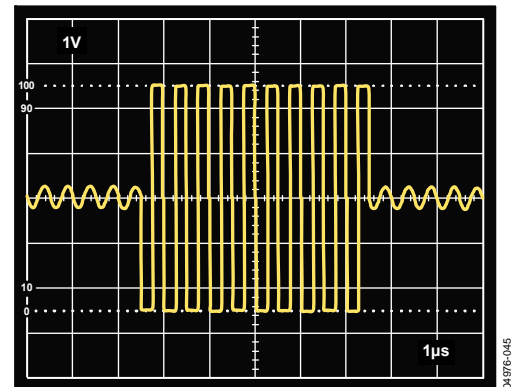

Figure 44. Preamp Overdrive Recovery,  $50\text{ mV p-p}$  to  $1.5\text{ V p-p}$  at Preamp Input (Measured at Preamp Output)



Figure 45. VGA Overdrive Recovery, 40 mV to 500 mV Input,  $V_{GAIN} = 2.5 V$



Figure 47. Quiescent Supply Current vs. Temperature

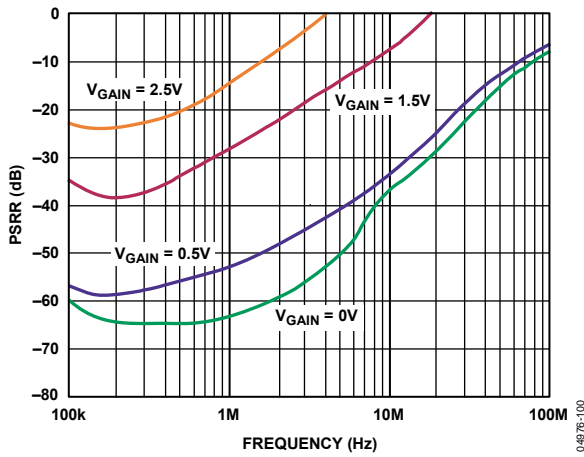

Figure 46. PSRR vs. Frequency (All Bypass Capacitors Removed)

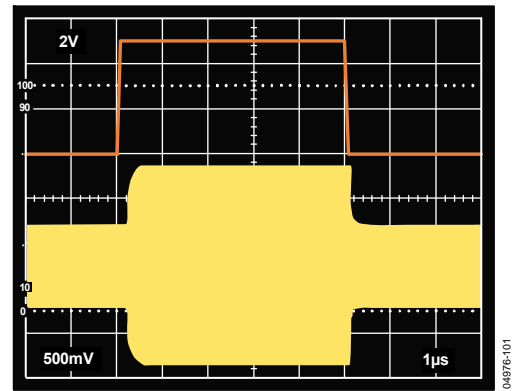

Figure 48 High/Low Response Time

TEST CIRCUITS

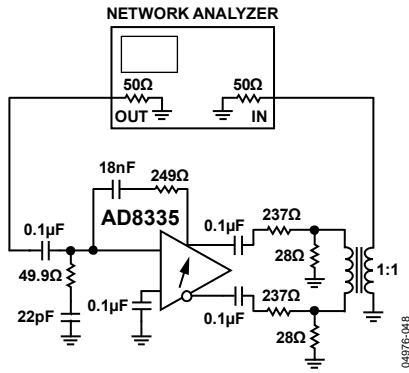

Figure 49. Test Circuit for Gain and Bandwidth Measurements

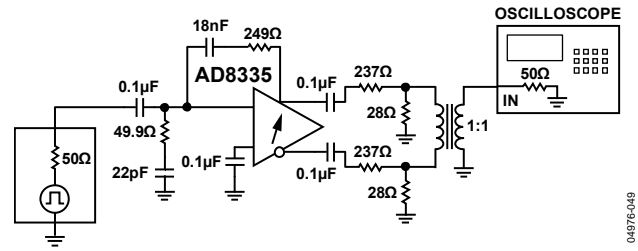

Figure 51. Test Circuit for Transient Measurements

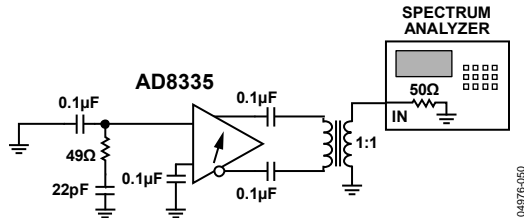

Figure 50. Test Circuit for Noise Measurements

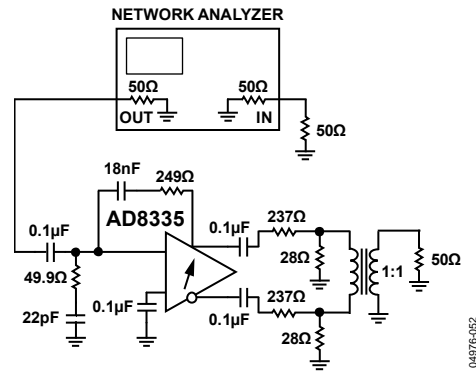

Figure 52. Test Circuit for S11 Measurements

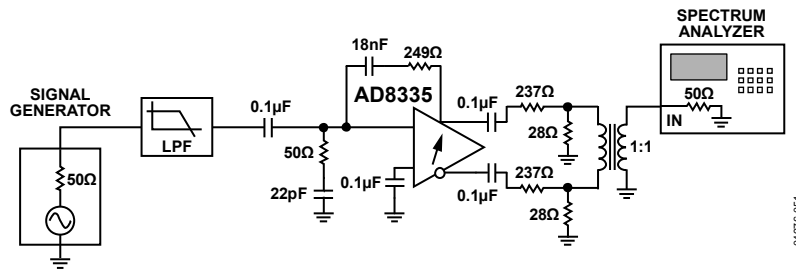

Figure 53. Test Circuit Used for Distortion Measurements

## THEORY OF OPERATION

Figure 54 is a simplified block diagram of a single channel. Each channel consists of a low noise preamplifier (PrA) followed by a VGA with a user-selectable gain of 20 dB or 28 dB. Channels are enabled in pairs, Channel 1 and Channel 2, and Channel 3 and Channel 4. The preamps are enabled by grounding the SPxx pins and powered down by connecting them to the positive supply. The ENxx pins are connected to the positive supply to enable the VGAs and the overall channel. HLxx configures VGA for a fixed gain of 20 dB or 28 dB, with 0 V or 5 V applied to the HLxx pins, respectively. Channel 1 and Channel 2 share Pin HL12, and Channel 3 and Channel 4 share Pin HL34. The HLxx pins are typically hardwired to adjust the VGA gain according to an ADC resolution of 12 bits for low gain and 10 bits for high gain.

The signal path is fully differential throughout to maximize signal swing and reduce even-order distortion; however, the preamplifiers are designed to be driven from a single-ended signal source. Gain values are referenced from the single-ended PrA input to the differential output of either the PrA or the VGA. Again referring to Figure 54, the system gain is distributed as listed in Table 4.

In the remainder of this document, the gain values are rounded to  $-10$  dB to  $+38$  dB for low gain mode and to  $-2$  dB to  $+46$  dB for high gain mode. If desired, Equation 1 can be used to calculate the gain at a value of  $V_{GAIN}$ .

$$Gain[dB] = 20.1 \frac{dB}{V} VGN + ICPT \quad (1)$$

where  $ICPT = -16.1$  dB for low gain mode  $-8.1$  dB for high gain mode.

Power consumption is 95 mW/channel from a 5 V supply, or 380 mW for all four channels. Power is distributed 35% for the PrA, and 65% for the remainder of the circuit. The preamps can be shut down via the SP12 and SP34 pins if a user wants to use the VGAs only. However, to avoid feedthrough around the preamp, feedback resistors should not be installed.

**Table 4. Channel Gain Distribution**

Section	Low Nominal Gain (dB)	High Nominal Gain (dB)
PrA	18.06	18.06
Attenuator	0 to $-48.16$	0 to $-48.16$
Output Amp	20	27.96
Aggregate	$-10.1$ to $+38.6$	$-2.14$ to $+46.02$

## ENABLE SUMMARY

Table 5 summarizes the enable/shutdown logic and resulting supply current.

**Table 5. Control Pin Logic and Power Consumption**

EN12	SP12	EN34	SP34	PrA1/PrA2	VGA1/VGA2	PrA3/PrA4	VGA3/VGA4	I <sub>s</sub>
High	Low	High	Low	On	On	On	On	76 mA
High	High	High	High	Off	On	Off	On	52 mA
Low	Low	Low	Low	Off	Off	Off	Off	0.8 mA
Low	High	Low	High	Off	Off	Off	Off	0.8 mA



Figure 54. Simplified Block Diagram of Single Channel



## PREAMP

Although the preamp signal path is fully differential, the design is optimized for single-ended input drive and signal source resistance matching. Thus, the negative input to the differential preamplifier PMD<sub>x</sub> pins must be ac-grounded to provide a balanced differential signal at the PrA outputs. Detailed information regarding the preamplifier architecture is found in the LNA section of the AD8331/AD8332 data sheet.

The preamplifier consists of a fixed gain amplifier with differential outputs. With the negative output available and a fixed gain of 8 (18.06 dB), an active input termination is synthesized by connecting a feedback resistor between the negative output and the positive input, Pin PIP<sub>x</sub>. This technique is well known and results in the input resistance shown in Equation 2.

$$R_{IN} = \frac{R_{FB}}{(1 + A/2)} \quad (2)$$

where  $A/2$  is the single-ended gain, or the gain from the PIP<sub>x</sub> inputs to the PON<sub>x</sub> outputs. Since the amplifier has a gain of  $\times 8$  from its input to its differential output, it is important to note that the gain  $A/2$  is the gain from Pin PIP<sub>x</sub> to Pin PON<sub>x</sub>, which is 6 dB lower, or 12.04 dB ( $\times 4$ ). The input resistance is reduced by an internal bias resistor of 14.7 k $\Omega$  in parallel with the source resistance connected to Pin PIP<sub>x</sub>, with Pin PMD<sub>x</sub> ac-grounded. Equation 3 can be used to calculate the needed  $R_{FB}$  for a desired  $R_{IN}$ , and is used for higher values of  $R_{IN}$ .

$$R_{IN} = \frac{R_{FB}}{(1 + 4)} \parallel 14.7 \text{ k}\Omega \quad (3)$$

For example, to set  $R_{IN} = 200 \Omega$ , the value of  $R_{FB}$  is 1.013 k $\Omega$ . If the simplified Equation 2 is used to calculate  $R_{IN}$ , the value is 197  $\Omega$ , resulting in a less than 0.1 dB gain error. Factors such as a widely varying source resistance might influence the absolute gain accuracy more significantly. At higher frequencies, the input capacitance of the PrA needs to be considered. The user must determine the level of matching accuracy and adjust  $R_{FB}$  accordingly.

The bandwidths (BW) of the preamplifier and VGA are approximately 110 MHz each, resulting in a cascaded BW of approximately 80 MHz. Ultimately the BW of the PrA limits the accuracy of the synthesized  $R_{IN}$ . For  $R_{IN} = R_S$  up to approximately 200  $\Omega$ , the best match is between 100 kHz and 10 MHz, where the lower frequency limit is determined by the size of the ac coupling capacitors, and the upper limit is determined by the preamplifier BW. Furthermore, the input capacitance and  $R_S$  limits the BW at higher frequencies.

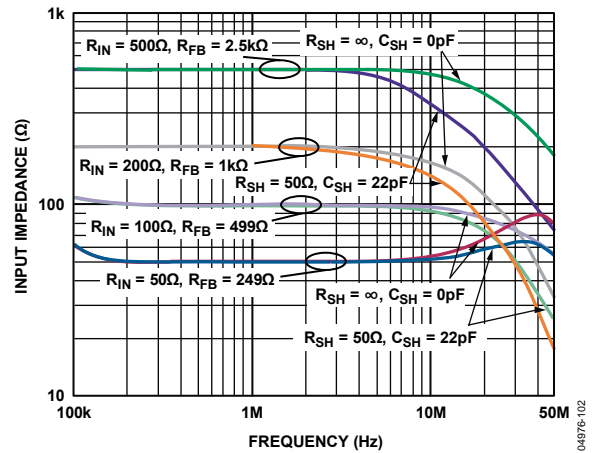

Figure 55.  $R_{IN}$  vs. Frequency for Various Values of  $R_{FB}$ ; Effects of  $R_{SH}$  and  $C_{SH}$  are also shown.

Figure 55 shows  $R_{IN}$  vs. frequency for various values of  $R_{FB}$ . Note that at the lowest value, 50  $\Omega$ ,  $R_{IN}$  peaks at frequencies greater than 10 MHz. This is due to the BW roll-off of the PrA as mentioned earlier. The  $R_{SH}$  and  $C_{SH}$  network shown in Figure 58 reduces this peaking.

However, as can be seen for larger  $R_{IN}$  values, parasitic capacitance starts rolling off the signal BW before the PrA can produce peaking and the  $R_{SH}/C_{SH}$  network further degrades the match. Therefore,  $R_{SH}$  and  $C_{SH}$  should not be used for values of  $R_{IN}$  greater than 50  $\Omega$ .

## Noise

The total input referred noise (IRN) is approximately 1.3 nV/ $\sqrt{\text{Hz}}$ . Allowing for a gain of  $\times 8$  in the preamp, the VGA noise is 0.46 nV/ $\sqrt{\text{Hz}}$  referred to the PrA input. The preamp noise is 1.2 nV/ $\sqrt{\text{Hz}}$ . It is important to note that these noise values include all amplifier noise sources, including the VGA and the preamplifier gain resistors. Frequently, manufacturer noise specifications exclude gain setting resistors, and the voltage noise spectral density of an op amp might be presented as 1 nV/ $\sqrt{\text{Hz}}$ . Including the gain resistors results in a much higher noise specification.

Figure 56 shows the simulated noise figure (NF) vs. source resistance, and various values of preamplifier  $R_{IN}$  from 50  $\Omega$  to 14.7 k $\Omega$ , the value seen looking into the PIPx pins when  $R_{FB} = \infty$ . As shown in the figure, the minimum NF for  $R_{IN} = 50 \Omega$  is slightly less than 7 dB. Note that, for this preamplifier, the NF is optimized for the  $R_{IN}$  from 50  $\Omega$  to 200  $\Omega$ ; for  $R_{FB} = \infty$ , the minimum NF is at approximately 480  $\Omega$ . This optimum noise resistance can also be calculated by dividing the input referred voltage noise by the current noise.



Figure 56. Simulated Noise Figure vs.  $R_S$  for Various Fixed Values of  $R_{IN}$ , Actively Matched

## VGA

As seen in Figure 54, the basic architecture, an X-AMP®, consists of a ladder attenuator, followed by a fixed gain amplifier with selectable input stages. Earlier examples of this architecture are to be found in the AD60x series, AD8331/AD8332, and AD8367 VGAs. Through a proprietary, temperature-compensated interpolator design, the bias currents to the input  $g_m$  stages are continuously steered from right to left (decreasing attenuation) resulting in increasing gain.

The HLxx gain pins (HL12 and HL34) select one of two output amplifier networks consisting of the feedback resistors, amplifier stages, and buffers.

### Optimizing the System Dynamic Range

The VGA output gain switch of 8 dB ( $\times 2.5$ ) optimizes the VGA noise floor for a 10-bit or 12-bit ADC, assuming a full-scale ADC input voltage of 1 V p-p.

At low gain, the ADC SNR should limit the system noise performance, whereas at high gains, the noise is defined by the source and preamplifier. The maximum voltage swing is bounded by the full-scale, peak-to-peak ADC input voltage (typically 1 V p-p to 2 V p-p). The noise performance is optimized by adjusting the noise floor of the VGA according to the ADC resolution. The SNR of a 12-bit converter is theoretically 12 dB better than a 10-bit; however, approximately 8 dB is typical in practice, accounting for the 8 dB gain option of the AD8335. The IRN and the power consumption of the VGA are unaffected by either gain setting; therefore, only the output referred noise (ORN) changes (by 8 dB) without affecting any other parameters.

## Attenuator

The attenuator is an 8-stage differential R-2R ladder with a total attenuation of 48.16 dB or 6.02 dB per tap. The effective input resistance per side is 320  $\Omega$  nominal for a total differential resistance of 640  $\Omega$ . The common-mode voltage of the attenuator and the VGA is controlled by an amplifier that uses the same midsupply voltage derived in the preamplifier, permitting dc coupling of the PrA to the VGA without introducing large offsets due to common-mode differences. However, when dc coupling between the PrA and VGA, any offset from the PrA is amplified as the gain is increased, producing an exponentially increasing VGA output offset. When the PrA and the VGA are ac-coupled, the output offset is unchanged with changes in gain (see Figure 15). As a result, ac coupling is recommended for most applications. As can be seen from Figure 54, The VCMx pins connect to the respective midpoints on each channel and are used to ac decouple the common-mode node at high frequencies. It is very important that at least a 0.1  $\mu$ F capacitor be used, with better decoupling at higher frequencies when another smaller capacitor (10 nF) is connected in parallel. The internal +1 buffer provides correct common-mode bias levels and any dynamic currents have to be absorbed by the external decoupling capacitors.

## Gain Control

The gain control interface has two inputs,  $V_{GAIN}$  (VGNx pins) and VSLP (SLxx pins). The slope input is intended only as a decoupling pin, and the only guaranteed gain slope is the 20 dB/V default. However, if a voltage is applied to the VSLP inputs, the gain slope can be increased by reducing the slope voltage. For example, if a voltage of 1.67 V is applied to the SLxx pins, the gain slope changes to 30 dB/V. Use Equation 4 to calculate the gain slope.

$$VSLP = \frac{2.5 V \times 20.1 \text{ dB/V}}{\text{Slope}} \quad (4)$$

$V_{GAIN}$  varies the gain of the VGA through the interpolator by selecting the appropriate input stages connected to the input attenuator. The nominal  $V_{GAIN}$  range for 20 dB/V is 0 V to 3 V, with the best gain linearity from approximately 0.5 V to 2.5 V, where the error is typically less than  $\pm 0.2$  dB. For  $V_{GAIN}$  voltages above 2.5 V and less than 0.5 V, the error increases (see Figure 4). The value of the  $V_{GAIN}$  voltage can be increased to that of the supply voltage, without gain foldover.

Each channel has separate gain control pins that can be connected to a common voltage source such as found in most ultrasound applications. For control of individual channels, connect the appropriate gain control signal to each channel.

### Output Stage

Duplicate output stages of the VGA provide an 8 dB ( $\times 2.5$ ) gain switch. The gain switch is intended to optimize the output noise floor for either a 10-bit or a 12-bit ADC. The VGA gain is 20 dB ( $\times 10$ ) in low gain mode and 28 dB ( $\times 25$ ) in high gain mode. The logic setting of the HLxx pins selects between output amplifiers including the gain resistors and feedback buffers.

100 MHz bandwidth is maintained between the amplifiers by changing the compensation capacitance as the gain switches gain settings. Power consumption is the same for either level of gain.

In certain applications, power consumption can be reduced by lowering the supply voltage as much as possible; however, the output dynamic range is affected by the more limited swing. The fully differential signal path of the AD8335 restores 6 dB of dynamic range, and the common-mode level is maintained automatically at half the supply voltage for maximum signal swing. The differential signal has the added benefit of suppressing the even order harmonics.

The output amplifier is designed to drive a nominal differential load of 500  $\Omega$  or greater; the signal swing can be as large as 5 V p-p differential before clipping occurs. However, that distortion increases before reaching the clipping level. Distortion is shown in Figure 25 through Figure 34 for typical values of 1 V p-p or 2 V p-p (full-scale inputs for many ADCs). The output is ac-coupled to a differential antialias filter driving a differential ADC. Most modern ADCs have differential inputs and achieve optimum performance when driven differentially. For more information, see the Applications Information section.

### VGA Noise

As with all X-AMPs, the output noise of the VGA is constant with gain. This causes the input referred noise to increase as the gain is decreased. This characteristic is desirable in receiver applications where wide dynamic range input signals are compressed with a fixed ceiling and noise floor into an ADC. The VGA output noise is approximately 33 nV/ $\sqrt{\text{Hz}}$  in low gain mode and 2.5 times higher than this, 83 nV/ $\sqrt{\text{Hz}}$ , in high gain mode. As the gain increases, the noise of the preamplifier prevails and, at the maximum VGA gain, the output noise is approximately 90 nV/ $\sqrt{\text{Hz}}$  and 225 nV/ $\sqrt{\text{Hz}}$  for low and high gain modes, respectively.

The output SNR is determined by the noise floor and the largest signal level, typically limited by the FS of the ADC. Modulation noise, essentially the noise introduced by the gain control input, can be troublesome. Normally one tends to look at the main amplifier signal path for noise, but a VGA is really a multiplier with the following function:

$$V_{OUT} = \frac{V_{GAIN} \times V_{IN}}{V_{REF}} \quad (5)$$

where  $V_{REF}$  (bias) and  $V_{GAIN}$  (gain control interface) are both noise contributors under certain conditions. It is therefore important that the gain control signals be kept clean, especially at higher gain control slopes.

## APPLICATIONS INFORMATION

### ULTRASOUND

The primary application for the AD8335 is medical ultrasound. Figure 57 shows a simplified block diagram of an ultrasound system. The most critical function of an ultrasound system is the time gain control (TGC) compensation for physiological signal attenuation. Because the attenuation of ultrasound signals is exponential with respect to distance (time), a linear-in-dB VGA is the optimal solution.

Key requirements in an ultrasound signal chain are very low noise, active input termination, fast overload recovery, low power, and differential drive to an ADC. Because ultrasound machines use beamforming techniques requiring large binary weighted numbers (for example, 32 to 512) of channels, the lowest power at the lowest possible noise is of key importance.

Most modern machines use digital beamforming. In this technique, the signal is converted to digital format immediately following the TGC amplifier; beamforming is done digitally.

Typical ADC resolution in general purpose machines is 10 bits with sampling rates greater than 40 MSPS, and high-end systems use 12 bits.

Power consumption and low cost are of primary importance in low-end and portable ultrasound machines, and the AD8335 is designed for these criteria.

For additional information regarding ultrasound systems, refer to “How Ultrasound System Considerations Influence Front-End Component Choice”, Analog Dialogue, Vol. 36, No. 3, May–July 2003. ([www.analog.com/library/analogDialogue/archives/36-03/ultrasound/index.html](http://www.analog.com/library/analogDialogue/archives/36-03/ultrasound/index.html))



Figure 57. Simplified Ultrasound System Block Diagram

04876-053

**BASIC CONNECTIONS**

Figure 58 shows the basic connections for the AD8335. Input signals enter from the left and output signals exit from the right, providing straight line signal paths. Of course, a device with four differential VGAs such as this requires a multilayer printed circuit board. Power supply isolation is shown for the preamps, and for the VGA sections. If components are mounted to both sides of the board, those in the signal path should be located on the top, with power-supply decoupling components on the wiring side.

**PREAMP CONNECTIONS**

To configure the AD8335 for input matching, a feedback resistor ( $R_{FB}$ ) is ac-coupled between Pin PONx and Pin PIPx. AC coupling accommodates dissimilar common-mode voltages at the input and output ports. For values of  $R_{SOURCE}$  between 50  $\Omega$  and 200  $\Omega$ ,  $R_{FB}$  is simply  $5 \times R_{SOURCE}$ . Table 6 lists a few larger values of source

resistor (or  $R_{IN}$ ), along with the exact value and nearest standard 1% feedback resistor. For values other than those listed in Table 6,  $R_{FB}$  can be calculated using Equation 6. For values larger than 1 k $\Omega$ , it may be advantageous to simply remove  $R_{FB}$ .

**Table 6. Feedback Resistor Values for Various Input Resistances**

$R_{IN}$ ( $\Omega$ )	Exact $R_{FB}$ Value ( $\Omega$ )	Nearest Standard 1% Value ( $\Omega$ )
200	1014	1.02 k
500	2588	2.61 k
1000	5365	5.36 k

$$R_{FB}(\Omega) = \frac{5 \times R_{IN}}{1 - \frac{R_{IN}}{14.7k}} \quad (6)$$

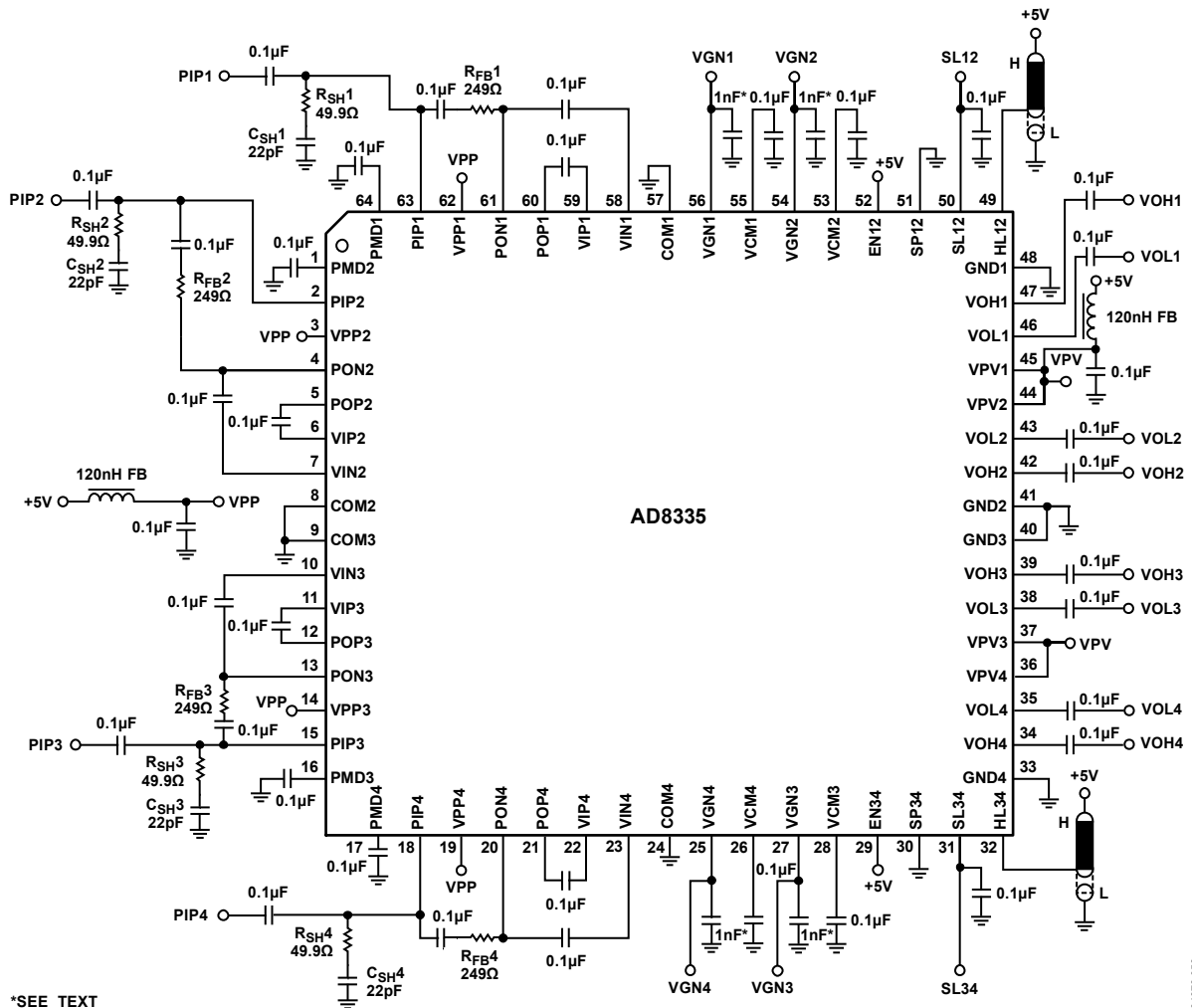

\*SEE TEXT

Figure 58. Basic Connections for  $R_{IN} = 50 \Omega$

04976-056

The preamp PMD pins must be capacitively coupled to ground. Although the preamplifier is a differential design, the PMD pins are the internal input bias nodes and are made available for bypassing only. Do not use these pins as signal inputs.

The PIPx inputs must be capacitively coupled from the signal source because they have a nominal dc level of more than half the supply voltage. AC coupling capacitors throughout the circuit should be as large as possible for the application. Although 0.1  $\mu\text{F}$  capacitors are shown in Figure 58 (and used in most positions in the evaluation board), values of these capacitors should be determined by the application. Capacitors used for coupling PMDx and PIPx pins should be the same value.

When synthesizing low values of  $R_{IN}$ , the bandwidth of the preamplifier produces some peaking at the high end of the frequency response. The optional series  $R_{SHX}/C_{SHX}$  network shown in Figure 58 flattens the response (see Figure 55). With a 50  $\Omega$  source, the resistor and capacitor values should be 49.9  $\Omega$  and 22 pF. For  $R_S$  values greater than 100  $\Omega$ , the network is not needed. The circuit is stable in either scenario.

The starred capacitors in Figure 58 (\*) on the VGNx pins can be removed when faster gain control signals are required.

## INPUT OVERDRIVE

Excellent overload behavior is of primary importance in ultrasound. Both the preamplifier and VGA have built-in overdrive protection and quickly recover after an overload event.

### Input Overload Protection

As with any amplifier, voltage clamping prior to the inputs is highly recommended if the application is subject to high transient voltages.

A block diagram of a simplified ultrasound transducer interface is shown in Figure 59. A common transducer element serves the dual functions of transmit and receive of ultrasound energy. During the transmit phase, high voltage pulses are applied to the ceramic elements. A typical T/R (transmit/receive) switch may consist of four high voltage diodes in a bridge configuration. Although they ideally block transmit pulses from the sensitive receiver input, diode characteristics are not ideal, and resulting leakage transients impinging on the PIPx inputs can be problematic.

Because ultrasound is a pulse system, and time-of-flight is used to determine depth, quick recovery from input overloads is essential. Overload can occur in the preamp and the VGA. Immediately following a transmit pulse, the typical VGA gains are low, and the PrA is subject to overload from T/R switch leakage. With increasing gain, the VGA can become overloaded from strong echoes that occur with near field echoes and acoustically dense materials, such as bone.

Figure 59 illustrates an external overload protection scheme. A pair of back-to-back Schottky diodes is installed prior to installing the ac-coupling capacitors. Although the BAS40 is shown, many types are available and merit investigation by the user. With such

diodes, clamping levels of  $\pm 0.5$  V or less greatly enhance the system overload performance.



Figure 59. Input Overload Protection

## LOGIC INPUTS

The EN12 and EN34 enable pins, the SP12 and SP34 preamp shutdown pins, and the HL12 and HL34 high/low pins are all logic inputs of the AD8335. The enable inputs turn on and off each of the corresponding pairs of channels; the preamp shutdown pins do the same for the preamplifiers only; inputs HL12 and HL34 set the high/low gain for Channel 1 and Channel 2, and Channel 3 and Channel 4, respectively.

Shutting down the preamplifiers allows use of the VGAs alone, while reducing power consumption. The VGAs cannot be shut down independently. The SPxx (shutdown preamp) pins are logic high; thus, the pins are grounded to enable the preamplifiers.

The pins can be enabled by connecting to the supply or to ground for fixed enable or disable, or to the output of a logic device. Be sure to check the data sheet of the device for voltage and current requirements.

## COMMON-MODE PINS

The common-mode VCMx pins are provided for bypassing the internal common-mode reference for each channel to ground. They require a capacitor at each of the four pins and can neither be connected together nor driven by an external source.

## DRIVING ADCs

The AD8335 VGA is designed to drive 10-bit and 12-bit ADCs with minimal extra components. Because the AD8335 is a single supply 5 V part and many of the newest ADCs operate from a 3 V supply, dissimilar common-mode voltages exist between the VGA output and the ADC input. This level shift is most easily accommodated by ac coupling, especially if the signal is filtered, as is the case in most ultrasound and communications applications.

When an antialiasing filter (AAF) is called for, it is advantageous to implement a differential configuration. A fully differential AAF requires approximately 1.5 times the number of components than a single-ended filter, because the components that in the single-ended case are tied to ground, now connect across the differential signal path. Although the series components double, the component count for the differential filter is more economical when compared to simply building a pair of single-ended filters requiring twice as many components.



## EVALUATION BOARD

The AD8335 evaluation board is a convenient way to experiment with the operation and features of the AD8335 quad VGA. Switches connect or disconnect the low noise preamp and VGA channels and the two gain ranges. Just connect a 5 V/200 mA power supply to the red and black test loop and a differential probe (or two single-ended scope probes) to the output 2-pin headers to observe the output voltage. Test loops are also provided for the gain voltage inputs, which are typically dc bias voltages between 0 V and 3 V. The LNA and VGA channels are enabled independently. All channels are tested functionally before shipment. The low noise preamp active input matching is configured for 50  $\Omega$  to terminate a corresponding signal generator or network

analyzer. Input impedances up to 14.7 k $\Omega$  are possible by adjusting  $R_{FB}^1$  through  $R_{FB}^4$  using the resistor values listed in Table 6. All passive components are 0603 size surface-mount components. A low noise voltage source (be careful of noise at the switching supply terminals) is recommended for gain control voltage (VGN1, VGN2, VGN3, and VGN4) inputs.

### BOARD LAYOUT

The evaluation board has a four-layer construction that provides a solid near-zero impedance ground, with power and ground on the inner layers, and interconnecting circuitry on the outer layers. Figure 63 through Figure 68 illustrate various board layers.

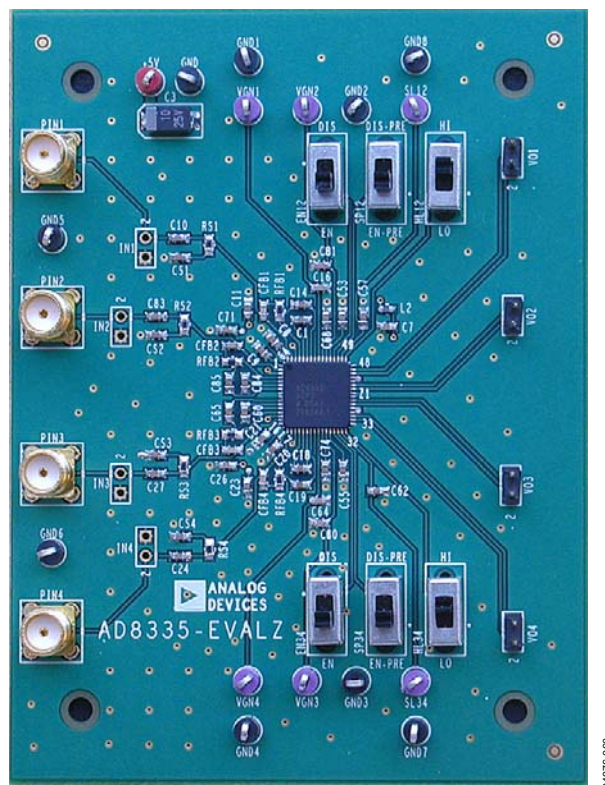

Figure 60. Photograph of the AD8335-EVALZ Evaluation Board







Figure 62. AD8335-EVALZ Typical Test Connections

0497E-063



Figure 63. AD8335-EVALZ Assembly

04976-064

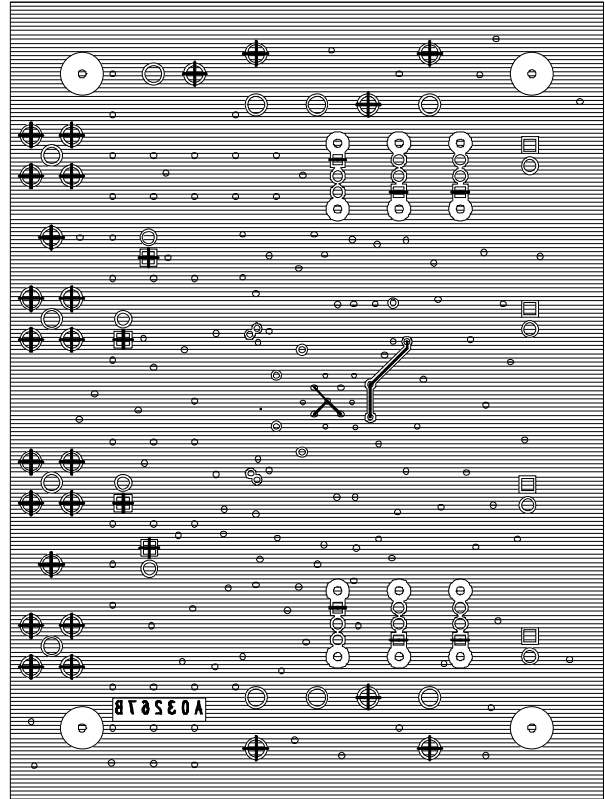

Figure 65. AD8335-EVALZ Secondary Side Copper

04976-068



Figure 64. AD8335-EVALZ Component Side Copper

04976-065

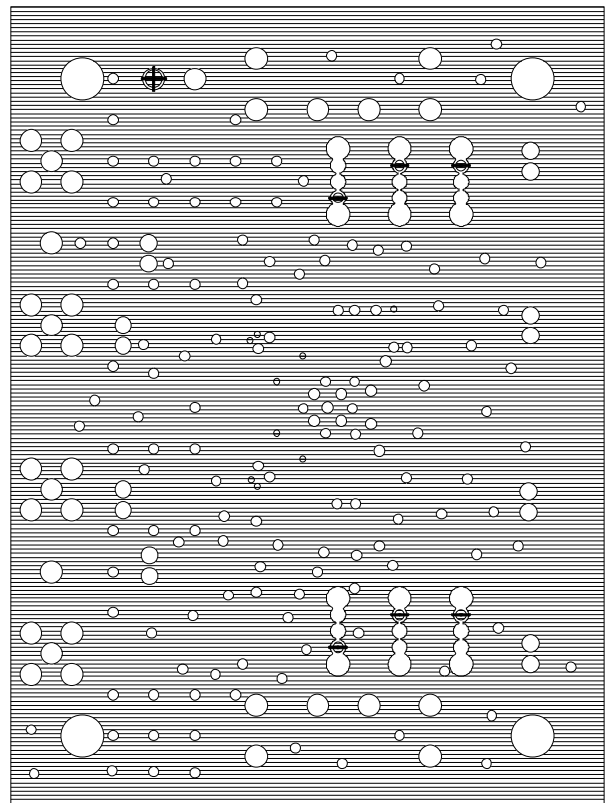

Figure 66. AD8335-EVALZ Internal Power Plane

04976-070



Figure 67. AD8335-EVALZ Internal Ground Plane

04976-071

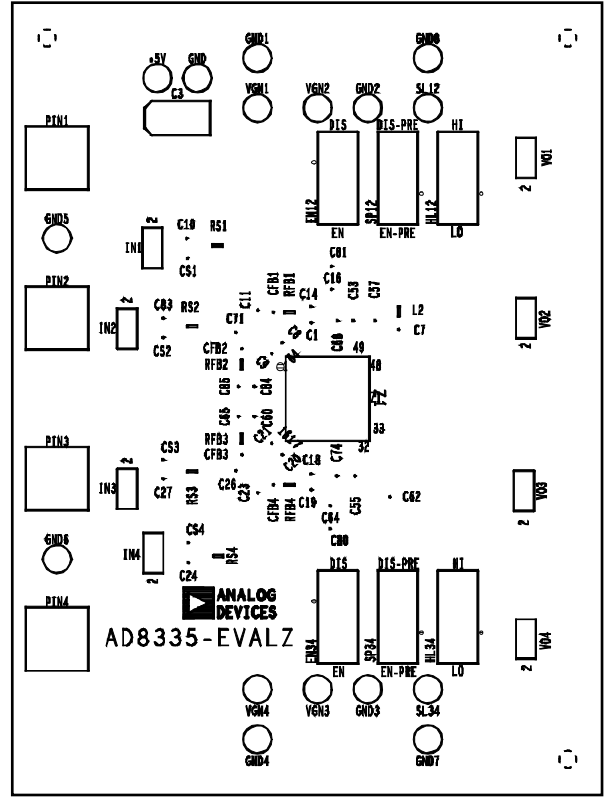

Figure 68. AD8335-EVALZ Primary Side Silk screen

04976-072

OUTLINE DIMENSIONS



\*COMPLIANT TO JEDEC STANDARDS MO-220-VMM4-4 EXCEPT FOR EXPOSED PAD DIMENSION

Figure 69. 64-Lead Lead Frame Chip Scale Package [LFCSP\_VQ]  
 9 mm × 9 mm Body, Very Thin Quad  
 (CP-64-1)  
 Dimensions shown in millimeters

ORDERING GUIDE

Model <sup>1</sup>	Temperature Range	Package Description	Package Option
AD8335ACPZ	-40°C to +85°C	64-Lead Lead Frame Chip Scale Package [LFCSP_VQ]	CP-64-1
AD8335ACPZ-REEL	-40°C to +85°C	64-Lead Lead Frame Chip Scale Package [LFCSP_VQ]	CP-64-1
AD8335ACPZ-REEL7	-40°C to +85°C	64-Lead Lead Frame Chip Scale Package [LFCSP_VQ]	CP-64-1
AD8335-EVALZ		Evaluation Board	

<sup>1</sup> Z = RoHS Compliant Part.

## Данный компонент на территории Российской Федерации

### Вы можете приобрести в компании MosChip.

Для оперативного оформления запроса Вам необходимо перейти по данной ссылке:

<http://moschip.ru/get-element>

Вы можете разместить у нас заказ для любого Вашего проекта, будь то серийное производство или разработка единичного прибора.

В нашем ассортименте представлены ведущие мировые производители активных и пассивных электронных компонентов.

Нашей специализацией является поставка электронной компонентной базы двойного назначения, продукции таких производителей как XILINX, Intel (ex.ALTERA), Vicor, Microchip, Texas Instruments, Analog Devices, Mini-Circuits, Amphenol, Glenair.

Сотрудничество с глобальными дистрибьюторами электронных компонентов, предоставляет возможность заказывать и получать с международных складов практически любой перечень компонентов в оптимальные для Вас сроки.

На всех этапах разработки и производства наши партнеры могут получить квалифицированную поддержку опытных инженеров.

Система менеджмента качества компании отвечает требованиям в соответствии с ГОСТ Р ИСО 9001, ГОСТ РВ 0015-002 и ЭС РД 009

### Офис по работе с юридическими лицами:

105318, г.Москва, ул.Щербаковская д.3, офис 1107, 1118, ДЦ «Щербаковский»

Телефон: +7 495 668-12-70 (многоканальный)

Факс: +7 495 668-12-70 (доб.304)

E-mail: [info@moschip.ru](mailto:info@moschip.ru)

Skype отдела продаж:

moschip.ru

moschip.ru\_4

moschip.ru\_6

moschip.ru\_9