

ZXRE1004
SOT23 MICROPOWER (4µA) 1.22V VOLTAGE REFERENCE

Description

The ZXRE1004 is a 1.22 volt bandgap reference circuit designed for ultra low current operation, typically 4µA. The device is available in a SOT23 surface mount package offering the ultimate in space and power saving. These features make the ZXRE1004 particularly suitable for portable and battery powered applications.

SOT23 tolerance selection is available to 0.5% for precision applications. Excellent performance is maintained over the 8µA to 20mA operating current range with a typical temperature coefficient of only 20ppm/°C. The device has been designed to be highly tolerant of capacitive loads so maintaining excellent stability.

As well as the SOT23, the ZXRE1004 can offer a pin for pin compatible alternative to the REF1004, LT1004 and LM185/385 series of voltage references with an E-Line (TO92 style) equivalent.

Features

- High performance alternative to REF1004, LT1004 and LM185/385 references
- 4µA typical knee current
- Small outline SOT23 package
- 20ppm/°C typical temperature coefficient
- Unconditionally stable
- 1% tolerance
- Contact Diodes marketing for availability of tighter tolerance devices
- "Green molding compound"

Applications

- Battery powered equipment
- Precision power supplies
- Portable instrumentation
- Portable communications devices
- Notebook and palmtop computers
- Data acquisition systems
- A/D and D/A converters
- Test equipment

Applications Circuit

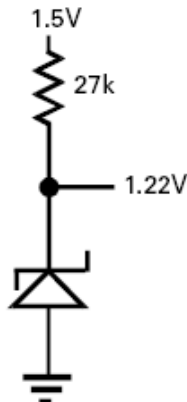

Pin Assignments

SOT23 Package Suffix - F



(Top View)

Pin 1 floating or connected to pin 2

E-Line, 3 pin, Rev Package Suffix – R

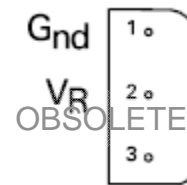

(Bottom View)

Pin 3 floating or connected to pin 1

Schematic Diagram

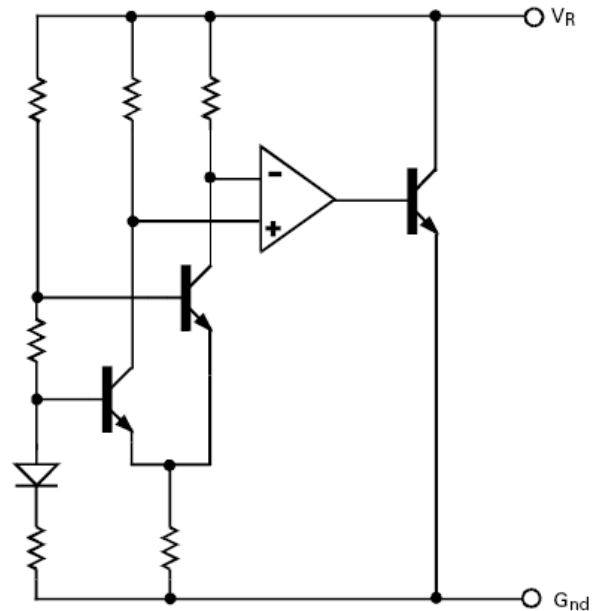

Absolute Maximum Ratings (Voltages to GND Unless Otherwise Stated)

Parameter	Rating	Unit
Reverse Current	30	mA
Forward Current	10	mA
Operating Temperature	-40 to 85	°C
Storage Temperature	-55 to 125	°C
Power Dissipation (T _{AMB} = 25°C) SOT23	330	mW

Electrical Characteristics (Test conditions: T_{amb} = 25°C, unless otherwise specified.)

Symbol	Parameter	Condition	Min.	Typ.	Max.	Tol. (%)	Unit
V _R	Reverse breakdown voltage	I _R = 100µA	1.208 1.183	1.22 1.22	1.232 1.257	1 3	V
I _{MIN}	Minimum knee current			4	8		µA
I _R	Recommended operating current range		0.008		20		mA
T _C ^(*)	Average reverse breakdown voltage temperature coefficient	I _R (MIN) to I _R (MAX)		20	75		ppm/°C
$\frac{\Delta V_R}{\Delta I_R}$	Reverse breakdown voltage change with current	I _R =8µA to 1mA I _R =1mA to 20mA			1 10		mV
Z _R	Reverse dynamic impedance	I _R = 1mA f = 100Hz I _{AC} = 0.1I _R		0.2	0.6		Ω
E _N	Wideband noise voltage	I _R =8µA to 100µA f=10Hz to 10kHz		60			µV(rms)

Notes:

$$(*) T_C = \frac{(V_{R(MAX)} - V_{R(MIN)}) \times 1000000}{V_R \times (T_{(MAX)} - T_{(MIN)})}$$

Note: V_{R(MAX)} - V_{R(MIN)} is the maximum deviation in reference voltage measured over the full operating temperature range.

(†) 0.5% SOT23 only

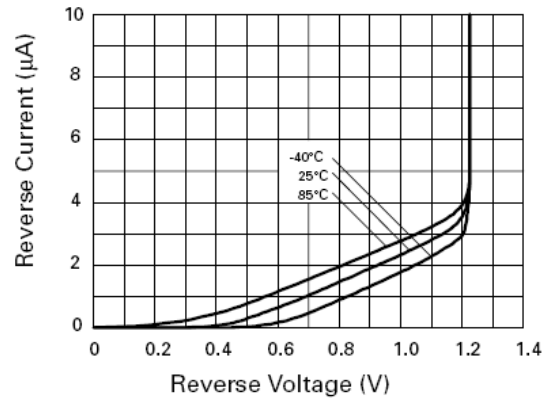

Reverse Characteristics

Typical Characteristics

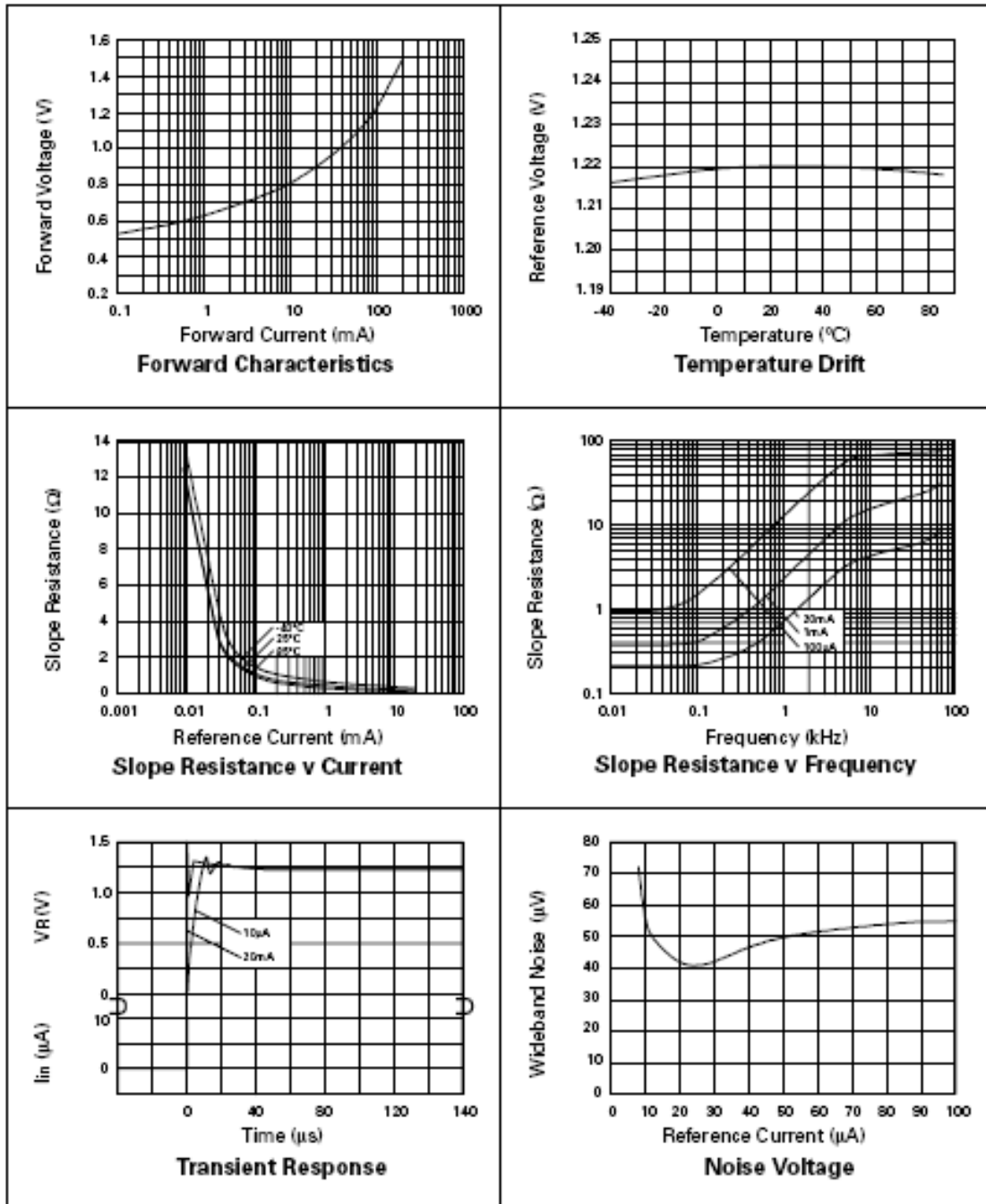

Ordering Information^(*)

Order Reference	Tol (%)	Package	Device Mark	Status (*)	Reel Size (inches)	Quantity per reel	Tape Width (mm)
ZXRE1004CF TA	0.5	SOT23	10D	Obsolete	7	3000	8
ZXRE1004DF TA	1	SOT23	10C	Released	7	3000	8
ZXRE1004EF TA	2	SOT23	10B	NRND	7	3000	8
ZXRE1004FF TA	3	SOT23	10A	Released	7	3000	8

Notes: *All ZXRE1004xR variants (E-Line) are obsolete.
NRND = Not Recommended for New Designs
For tape and reel options add suffix TA to the part number eg ZXRE1004DF TA

Package Outline Dimensions

SOT23

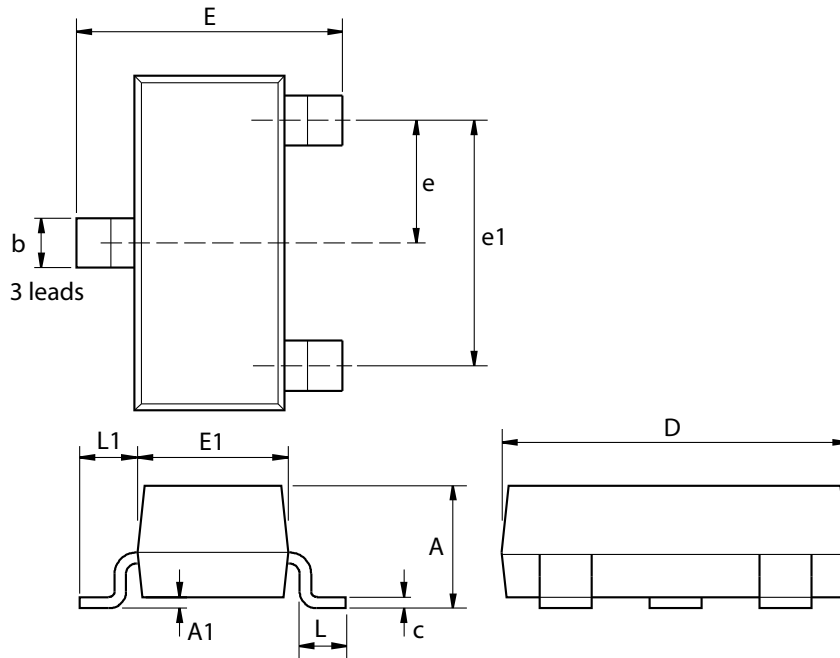

Dim.	Millimeters		Inches		Dim.	Millimeters		Inches	
	Min.	Max.	Min.	Max.		Min.	Max.	Min.	Max.
A	-	1.12	-	0.044	e1	1.90 NOM		0.075 NOM	
A1	0.01	0.10	0.0004	0.004	E	2.10	2.64	0.083	0.104
b	0.30	0.50	0.012	0.020	E1	1.20	1.40	0.047	0.055
c	0.085	0.20	0.003	0.008	L	0.25	0.60	0.0098	0.0236
D	2.80	3.04	0.110	0.120	L1	0.45	0.62	0.018	0.024
e	0.95 NOM		0.037 NOM		-	-	-	-	-

Note: Controlling dimensions are in millimeters. Approximate dimensions are provided in inches

IMPORTANT NOTICE

DIODES INCORPORATED MAKES NO WARRANTY OF ANY KIND, EXPRESS OR IMPLIED, WITH REGARDS TO THIS DOCUMENT, INCLUDING, BUT NOT LIMITED TO, THE IMPLIED WARRANTIES OF MERCHANTABILITY AND FITNESS FOR A PARTICULAR PURPOSE (AND THEIR EQUIVALENTS UNDER THE LAWS OF ANY JURISDICTION).

Diodes Incorporated and its subsidiaries reserve the right to make modifications, enhancements, improvements, corrections or other changes without further notice to this document and any product described herein. Diodes Incorporated does not assume any liability arising out of the application or use of this document or any product described herein; neither does Diodes Incorporated convey any license under its patent or trademark rights, nor the rights of others. Any Customer or user of this document or products described herein in such applications shall assume all risks of such use and will agree to hold Diodes Incorporated and all the companies whose products are represented on Diodes Incorporated website, harmless against all damages.

Diodes Incorporated does not warrant or accept any liability whatsoever in respect of any products purchased through unauthorized sales channel.

Should Customers purchase or use Diodes Incorporated products for any unintended or unauthorized application, Customers shall indemnify and hold Diodes Incorporated and its representatives harmless against all claims, damages, expenses, and attorney fees arising out of, directly or indirectly, any claim of personal injury or death associated with such unintended or unauthorized application.

Products described herein may be covered by one or more United States, international or foreign patents pending. Product names and markings noted herein may also be covered by one or more United States, international or foreign trademarks.

LIFE SUPPORT

Diodes Incorporated products are specifically not authorized for use as critical components in life support devices or systems without the express written approval of the Chief Executive Officer of Diodes Incorporated. As used herein:

A. Life support devices or systems are devices or systems which:

1. are intended to implant into the body, or
2. support or sustain life and whose failure to perform when properly used in accordance with instructions for use provided in the labeling can be reasonably expected to result in significant injury to the user.

B. A critical component is any component in a life support device or system whose failure to perform can be reasonably expected to cause the failure of the life support device or to affect its safety or effectiveness.

Customers represent that they have all necessary expertise in the safety and regulatory ramifications of their life support devices or systems, and acknowledge and agree that they are solely responsible for all legal, regulatory and safety-related requirements concerning their products and any use of Diodes Incorporated products in such safety-critical, life support devices or systems, notwithstanding any devices- or systems-related information or support that may be provided by Diodes Incorporated. Further, Customers must fully indemnify Diodes Incorporated and its representatives against any damages arising out of the use of Diodes Incorporated products in such safety-critical, life support devices or systems.

Copyright © 2010, Diodes Incorporated

www.diodes.com

Данный компонент на территории Российской Федерации

Вы можете приобрести в компании MosChip.

Для оперативного оформления запроса Вам необходимо перейти по данной ссылке:

<http://moschip.ru/get-element>

Вы можете разместить у нас заказ для любого Вашего проекта, будь то серийное производство или разработка единичного прибора.

В нашем ассортименте представлены ведущие мировые производители активных и пассивных электронных компонентов.

Нашей специализацией является поставка электронной компонентной базы двойного назначения, продукции таких производителей как XILINX, Intel (ex.ALTERA), Vicor, Microchip, Texas Instruments, Analog Devices, Mini-Circuits, Amphenol, Glenair.

Сотрудничество с глобальными дистрибьюторами электронных компонентов, предоставляет возможность заказывать и получать с международных складов практически любой перечень компонентов в оптимальные для Вас сроки.

На всех этапах разработки и производства наши партнеры могут получить квалифицированную поддержку опытных инженеров.

Система менеджмента качества компании отвечает требованиям в соответствии с ГОСТ Р ИСО 9001, ГОСТ РВ 0015-002 и ЭС РД 009

Офис по работе с юридическими лицами:

105318, г.Москва, ул.Щербаковская д.3, офис 1107, 1118, ДЦ «Щербаковский»

Телефон: +7 495 668-12-70 (многоканальный)

Факс: +7 495 668-12-70 (доб.304)

E-mail: info@moschip.ru

Skype отдела продаж:

moschip.ru

moschip.ru_4

moschip.ru_6

moschip.ru_9