

Patch cable - VS-04-2X2X26C7/7-67A/OE/1,0 - 1655742

Please be informed that the data shown in this PDF Document is generated from our Online Catalog. Please find the complete data in the user's documentation. Our General Terms of Use for Downloads are valid (<http://download.phoenixcontact.com>)



Assembled USB cable, shielded, color: RAL 5021 (water blue), PUR outer sheath, USB type A/IP67 on open cable end, length: 1 m



Key commercial data

Packing unit	1 pc
Weight per Piece (excluding packing)	97.6 GRM
Custom tariff number	85444290
Country of origin	Germany

Technical data

Mechanical characteristics

Number of positions	4
Shielded	Yes
Insertion/withdrawal cycles	≥ 500
Cable diameter	6.70 mm
Cable structure	2x2xAWG26/7 + 2xAWG20/19; S/FTP
Length of cable	1 m

Ambient conditions

Ambient temperature (operation)	-20 °C ... 60 °C (cable, fixed installation)
	0 °C ... 50 °C (cable, flexible installation)
	(Plug / socket)
Degree of protection	IP67

Material data

Housing material	PA
Sealing material	NBR
Material, O-ring	FPM

Patch cable - VS-04-2X2X26C7/7-67A/OE/1,0 - 1655742

Technical data

Material data

Outer sheath, material	PUR
External sheath, color	water blue RAL 5021

Electrical characteristics

Rated voltage (III/3)	125 V
Rated current	1 A
Transmission characteristics (category)	USB 2.0

Line characteristics

Cable type	FireWire
Cable structure	2x2xAWG26/7 + 2xAWG20/19; S/FTP
Conductor cross section	2x 2x 0.14 mm ² (signal line)
	2x 0.5 mm ² (Power supply)
AWG signal line	26
Conductor structure signal line	7x 0.15 mm
AWG power supply	20
Conductor structure, voltage supply	19x 0.20 mm
Core diameter including insulation	≤ 1.05 mm (signal line)
	nom. 1.4 mm (Power supply)
External cable diameter	6.7 mm
Wire colors	White-blue, white-orange, white, black
External sheath, color	water blue RAL 5021
Insulation resistance	5 GΩ*km
Conductor resistance	150 Ω/km
Transmission characteristics (category)	CAT7, for USB 2.0 (480 Mbps)
Working capacitance	42 pF (per meter)
Wave impedance	100 Ω ±5 % (at 100 MHz)
Signal speed	0.72 c
Signal runtime	4.6 ns/m
Shield attenuation	60 dB (Up to 1000 MHz)
Interference suppression	90 dB (Up to 1000 MHz)
Coupling resistance	5.00 mΩ/m (At 10 MHz)
Nominal voltage, cable	≤ 125 V
Test voltage, cable	1000 V
Twisted pairs	2 cores to the pair
Type of pair shielding	Aluminum-lined polyester foil
Overall twist	Two pairs and two power supply wires to the core
Shielding	Tinned copper braided shield

Patch cable - VS-04-2X2X26C7/7-67A/OE/1,0 - 1655742

Technical data

Line characteristics

Outer sheath, material	PUR
Material conductor insulation	Cell PE (signal line) PVC (Power supply)
Conductor material	Bare Cu litz wires
Cable weight	59 kg/km
Minimum bending radius, fixed installation	5 x D
Minimum bending radius, flexible installation	5 x D
Tensile strength short-term/long-term	≤ 30 N
Special properties	Free of substances which would hinder coating with paint or varnish
Flame resistance	complying with IEC 60332-2-2
Resistance to oil	according to EN 60811-2-1
Other resistance	Microbe resistance as per DIN VDE 0282 Hydrolysis resistance as per DIN 53504
Ambient temperature (operation)	-40 °C ... 70 °C (cable, fixed installation) -10 °C ... 50 °C (cable, flexible installation)

Classifications

eCl@ss

eCl@ss 4.0	27140816
eCl@ss 4.1	27260701
eCl@ss 5.0	27260701
eCl@ss 5.1	27260701
eCl@ss 6.0	27279218
eCl@ss 7.0	27279218
eCl@ss 8.0	27279218

ETIM

ETIM 2.0	EC000830
ETIM 3.0	EC001855
ETIM 4.0	EC001855
ETIM 5.0	EC001855

UNSPSC

UNSPSC 6.01	31261501
UNSPSC 7.0901	31261501
UNSPSC 11	31261501
UNSPSC 12.01	31261501

Patch cable - VS-04-2X2X26C7/7-67A/OE/1,0 - 1655742

Classifications

UNSPSC

UNSPSC 13.2	31261501
-------------	----------

Drawings

Schematic diagram

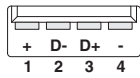

Pin assignment plug USB, type A

Dimensioned drawing

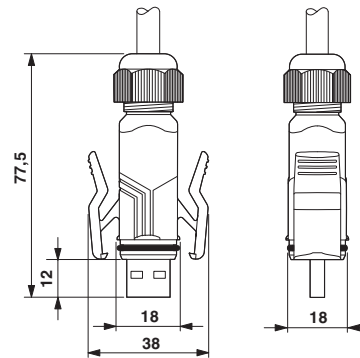

USB connector, type A, IP67

Circuit diagram

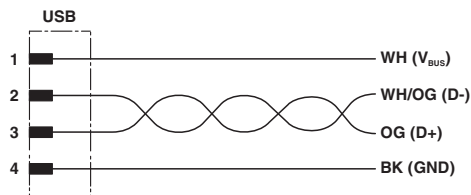

Данный компонент на территории Российской Федерации

Вы можете приобрести в компании MosChip.

Для оперативного оформления запроса Вам необходимо перейти по данной ссылке:

<http://moschip.ru/get-element>

Вы можете разместить у нас заказ для любого Вашего проекта, будь то серийное производство или разработка единичного прибора.

В нашем ассортименте представлены ведущие мировые производители активных и пассивных электронных компонентов.

Нашей специализацией является поставка электронной компонентной базы двойного назначения, продукции таких производителей как XILINX, Intel (ex.ALTERA), Vicor, Microchip, Texas Instruments, Analog Devices, Mini-Circuits, Amphenol, Glenair.

Сотрудничество с глобальными дистрибьюторами электронных компонентов, предоставляет возможность заказывать и получать с международных складов практически любой перечень компонентов в оптимальные для Вас сроки.

На всех этапах разработки и производства наши партнеры могут получить квалифицированную поддержку опытных инженеров.

Система менеджмента качества компании отвечает требованиям в соответствии с ГОСТ Р ИСО 9001, ГОСТ РВ 0015-002 и ЭС РД 009

Офис по работе с юридическими лицами:

105318, г.Москва, ул.Щербаковская д.3, офис 1107, 1118, ДЦ «Щербаковский»

Телефон: +7 495 668-12-70 (многоканальный)

Факс: +7 495 668-12-70 (доб.304)

E-mail: info@moschip.ru

Skype отдела продаж:

moschip.ru

moschip.ru_4

moschip.ru_6

moschip.ru_9