

## FEATURES

- Single in plane axis accelerometer with analog output
- Linear frequency response range from dc to 11 kHz (3 dB point)
- Resonant frequency of 21 kHz
- Ultralow noise density
  - 30  $\mu\text{g}/\sqrt{\text{Hz}}$  in  $\pm 100\text{ g}$  range (**ADXL1001**)
  - 25  $\mu\text{g}/\sqrt{\text{Hz}}$  in  $\pm 50\text{ g}$  range (**ADXL1002**)
- Overrange sensing plus dc coupling allows fast recovery time
- Complete electromechanical self-test
- Sensitivity performance
  - Sensitivity stability over temperature 5%
  - Linearity to  $\pm 0.1\%$  of full-scale range
  - Cross axis sensitivity  $\pm 1\%$  (ZX),  $\pm 1\%$  (YX),
- Single-supply operation
  - Output voltage ratiometric to supply
  - Low power consumption 1.0 mA
  - Power saving standby operation mode with fast recovery
- RoHS compliant
- $-40^{\circ}\text{C}$  to  $+125^{\circ}\text{C}$  temperature range
- 5 mm  $\times$  5 mm  $\times$  1.80 mm LFCSP package

## APPLICATIONS

- Condition monitoring
- Predictive maintenance
- Asset health
- Test and measurement
- Health usage monitoring system (HUMS)

## GENERAL DESCRIPTION

The **ADXL1001/ADXL1002** deliver ultralow noise density over an extended frequency range with two full-scale range options, and are optimized for industrial condition monitoring. The **ADXL1001** ( $\pm 100\text{ g}$ ) and the **ADXL1002** ( $\pm 50\text{ g}$ ) have typical noise densities of 30  $\mu\text{g}/\sqrt{\text{Hz}}$  and 25  $\mu\text{g}/\sqrt{\text{Hz}}$ , respectively. Both accelerometer devices have stable and repeatable sensitivity, which is immune to external shocks up to 10,000 g.

## FUNCTIONAL BLOCK DIAGRAM



Figure 1.

07510-001

The **ADXL1001/ADXL1002** have an integrated full electrostatic self test (ST) function and an overrange (OR) indicator that allow advanced system level features and are useful for embedded applications. With low power and single-supply operation of 3.3 V to 5.25 V, the **ADXL1001/ADXL1002** also enable wireless sensing product design. The **ADXL1001/ADXL1002** are available in a 5 mm  $\times$  5 mm  $\times$  1.80 mm LFCSP package, and are rated for operation over a  $-40^{\circ}\text{C}$  to  $+125^{\circ}\text{C}$  temperature range.

## TABLE OF CONTENTS

Features .....	1	Operating Modes.....	9
Applications.....	1	Bandwidth .....	9
Functional Block Diagram .....	1	Applications information .....	10
General Description .....	1	Application Circuit.....	10
Revision History .....	2	On Demand Self Test.....	10
Specifications.....	3	Ratiometric Output Voltage.....	10
Absolute Maximum Ratings.....	4	Interfacing Analog Output Below 10 kHz .....	11
Thermal Resistance .....	4	Interfacing Analog Output Beyond 10 kHz.....	12
Recommended Soldering Profile .....	4	Overrange .....	12
ESD Caution.....	4	Mechanical Considerations for Mounting.....	13
Pin Configuration and Function Descriptions.....	5	Layout and Design Recommendations .....	13
Typical Performance Characteristics .....	6	Outline Dimensions .....	14
Theory of Operation .....	9	Ordering Guide .....	14
Mechanical Device Operation .....	9		

## REVISION HISTORY

3/2017—Revision 0: Initial Version

## SPECIFICATIONS

$T_A = 25^\circ\text{C}$ ,  $V_{DD} = 5.0\text{ V}$ , acceleration = 0 g, unless otherwise noted.

Table 1.

Parameter <sup>1</sup>	Test Conditions/ Comments	ADX1001			ADX1002			Unit
		Min	Typ	Max	Min	Typ	Max	
SENSOR								
Measurement Range			±100			±50		g
Linearity	Percentage of full scale		±0.1			±0.1		%
Cross Axis Sensitivity <sup>2</sup>	ZX cross axis		±1.0			±1.0		%
	YX cross axis		±1.0			±1.0		%
SENSITIVITY (RATIOMETRIC TO $V_{DD}$ )								
Sensitivity	DC		20			40		mV/g
Sensitivity Change Due to Temperature <sup>3</sup>	$T_A = -40^\circ\text{C}$ to $+125^\circ\text{C}$		±5			±5		%
ZERO g OFFSET (RATIOMETRIC TO $V_{DD}$ )								
0 g Output Voltage			$V_{DD}/2$			$V_{DD}/2$		V
0 g Output Range over Temperature <sup>4</sup>	$-40^\circ\text{C}$ to $+125^\circ\text{C}$		5			5		g
NOISE								
Noise Density	100 Hz to 10 kHz		30			25		$\mu\text{g}/\sqrt{\text{Hz}}$
1/f Frequency Corner			0.1			0.1		Hz
FREQUENCY RESPONSE								
Sensor Resonant Frequency			21			21		kHz
5% Bandwidth <sup>5</sup>			4.7			4.7		kHz
3 dB Bandwidth <sup>5</sup>			11			11		kHz
SELF TEST								
Output Change (Ratiometric to $V_{DD}$ )	ST low to ST high	235	275		510	545		mV
Input Level								
High, $V_{IH}$		$V_{DD} \times 0.7$			$V_{DD} \times 0.7$			V
Low, $V_{IL}$				$V_{DD} \times 0.3$			$V_{DD} \times 0.3$	V
Input Current			25			25		$\mu\text{A}$
OUTPUT AMPLIFIER								
Short-Circuit Current			3			3		mA
Output Impedance			<0.1			<0.1		$\Omega$
Maximum Resistive Load			20			20		M $\Omega$
Maximum Capacitive Load <sup>6</sup>	No external resistor		100			100		pF
	With external resistor		22			22		nF
POWER SUPPLY ( $V_{DD}$ )								
Operating Voltage Range		3.3	5.0	5.25	3.3	5.0	5.25	V
Quiescent Supply Current			1.0	1.15		1.0	1.15	mA
Standby Current			225	285		225	285	$\mu\text{A}$
Standby Recovery Time (Standby to Measure Mode)	Output settled to 1% of final value		<50			<50		$\mu\text{s}$
Turn On Time <sup>7</sup>			<550			<550		$\mu\text{s}$
OPERATING TEMPERATURE RANGE								
		-40		+125	-40		+125	$^\circ\text{C}$

<sup>1</sup> All minimum and maximum specifications are guaranteed. Typical specifications may not be guaranteed.

<sup>2</sup> Cross axis sensitivity is defined as the coupling of excitation along a perpendicular axis onto the measured axis output.

<sup>3</sup> Includes package hysteresis from  $25^\circ\text{C}$ .

<sup>4</sup> Difference between maximum and minimum values in temperature range.

<sup>5</sup> Specified as frequency range that is within a deviation range relative to dc sensitivity, range is limited by an increase in response due to response gain at the sensor resonant frequency.

<sup>6</sup> For capacitive loads larger than 100 pF, an external series resistor must be connected (minimum 8 k $\Omega$ ). The output capacitance must not exceed 22 nF.

<sup>7</sup> Measured time difference from the instant  $V_{DD}$  reaches half its value to the instant at which the output settles to 1% of its final value.

## ABSOLUTE MAXIMUM RATINGS

Table 2.

Parameter	Rating
Acceleration (Any Axis, Unpowered)	10,000 g
Acceleration (Any Axis, Powered)	10,000 g
Drop Test (Concrete Surface)	1.2 m
V <sub>DD</sub>	-0.3 V to +5.5 V
Output Short-Circuit Duration (Any Pin to Common)	Indefinite
Temperature Range (Storage)	-55°C to +150°C

Stresses at or above those listed under Absolute Maximum Ratings may cause permanent damage to the product. This is a stress rating only; functional operation of the product at these or any other conditions above those indicated in the operational section of this specification is not implied. Operation beyond the maximum operating conditions for extended periods may affect product reliability.

### THERMAL RESISTANCE

Thermal performance is directly linked to printed circuit board (PCB) design and operating environment. Careful attention to PCB thermal design is required.

$\theta_{JA}$  is the natural convection junction to ambient thermal resistance measured in a one cubic foot sealed enclosure.  $\theta_{JC}$  is the junction to case thermal resistance.

Table 3. Package Characteristics

Package Type	$\theta_{JA}$	$\theta_{JC}$	Device Weight
CP-32-26 <sup>1</sup>	48°C/W	14.1°C/W	<0.2 g

<sup>1</sup> Thermal impedance simulated values are based on a JEDEC 252P thermal test board with nine thermal vias. See JEDEC JESD51.

### RECOMMENDED SOLDERING PROFILE

Figure 2 and Table 4 provide details about the recommended soldering profile.

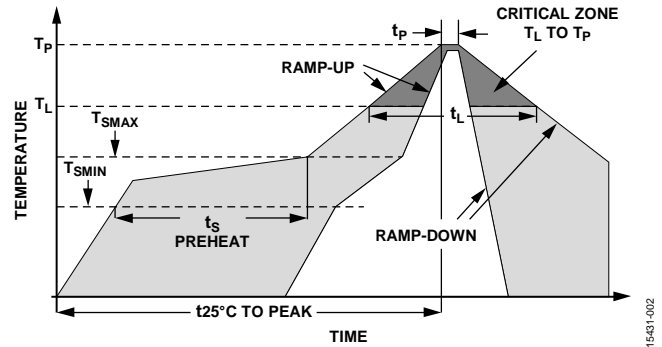

Figure 2. Recommended Soldering Profile

Table 4. Recommended Soldering Profile

Profile Feature	Condition	
	Sn63/Pb37	Pb-Free
Average Ramp Rate (T <sub>L</sub> to T <sub>P</sub> )	3°C/sec maximum	3°C/sec maximum
Preheat		
Minimum Temperature (T <sub>SMIN</sub> )	100°C	150°C
Maximum Temperature (T <sub>SMAX</sub> )	150°C	200°C
Time, T <sub>SMIN</sub> to T <sub>SMAX</sub> (t <sub>s</sub> )	60 sec to 120 sec	60 sec to 180 sec
T <sub>SMAX</sub> to T <sub>L</sub>		
Ramp-Up Rate	3°C/sec maximum	3°C/sec maximum
Time Maintained Above Liquidous (T <sub>L</sub> )		
Liquidous Temperature (T <sub>L</sub> )	183°C	217°C
Time (t <sub>t</sub> )	60 sec to 150 sec	60 sec to 150 sec
Peak Temperature (T <sub>P</sub> )	240°C + 0°C/-5°C	260°C + 0°C/-5°C
Time Within 5°C of Actual Peak Temperature (t <sub>p</sub> )	10 sec to 30 sec	20 sec to 40 sec
Ramp-Down Rate	6°C/sec maximum	6°C/sec maximum
Time 25°C to Peak Temperature (t <sub>25°C</sub> )	6 min maximum	8 min maximum

### ESD CAUTION



**ESD (electrostatic discharge) sensitive device.** Charged devices and circuit boards can discharge without detection. Although this product features patented or proprietary protection circuitry, damage may occur on devices subjected to high energy ESD. Therefore, proper ESD precautions should be taken to avoid performance degradation or loss of functionality.

# PIN CONFIGURATION AND FUNCTION DESCRIPTIONS



- NOTES**
1. NIC = NOT INTERNALLY CONNECTED.
  2. DNC = NO NOT CONNECT. LEAVE THIS PIN UNCONNECTED.
  3. THE EXPOSED PAD ON THE BOTTOM OF THE PACKAGE MUST BE CONNECTED TO GROUND.
  4. AXIS OF SENSITIVITY IS IN-PLANE TO THE PACKAGE AND HORIZONTAL AS SHOWN.

15431-003

Figure 3. Pin Configuration

Table 5. Pin Function Descriptions

Pin No.	Mnemonic	Description
1 to 9, 31, 32	NIC	Not Internally Connected.
10, 11, 17 to 19, 21 to 26, 29	DNC	Do Not Connect. Leave unconnected.
12	V <sub>DD</sub>	3.3 V to 5.25 V Supply Voltage.
13, 14, 27, 28	V <sub>SS</sub>	Supply Ground.
15	STANDBY	Standby mode Input, Active High.
16	ST	Self Test Input, Active High.
20	OR	Overrange Output. This pin instantaneously indicates when the overrange detection circuit identifies significant overrange activity. This pin is not latched.
30	V <sub>OUT</sub>	Analog Output Voltage.
33	EPAD	Exposed Pad. The exposed pad on the bottom of the package must be connected to ground.

TYPICAL PERFORMANCE CHARACTERISTICS



Figure 4. Frequency Response of ADXL1001/ADXL1002, High Frequency (>5 kHz) Vibration Response; a Laser Vibrometer Controller Referencing the ADXL1002 Package Used for Accuracy



Figure 7. ADXL1001/ADXL1002 Noise Power Spectral Density (Noise PSD) Below 10 Hz



Figure 5. ADXL1001 Noise Power Spectral Density (PSD) vs. Frequency



Figure 8. ADXL1002 Noise Power Spectral Density (PSD)



Figure 6. ADXL1001 Sensitivity vs. Temperature



Figure 9. ADXL1002 Sensitivity vs. Temperature



Figure 10. ADXL1001 Normalized Offset vs. temperature

15431-010



Figure 13. ADXL1002 Normalized Offset vs. Temperature

15431-013



Figure 11. ADXL1001/ADXL1002 Standby Current vs. Supply Voltage

15431-011



Figure 14. ADXL1001/ADXL1002 Measure Mode Supply Current vs. Supply Voltage

15431-014



Figure 12. ADXL1001 Sensitivity Histogram at 25°C

15431-112



Figure 15. ADXL1002 Sensitivity Histogram at 25°C

15431-015

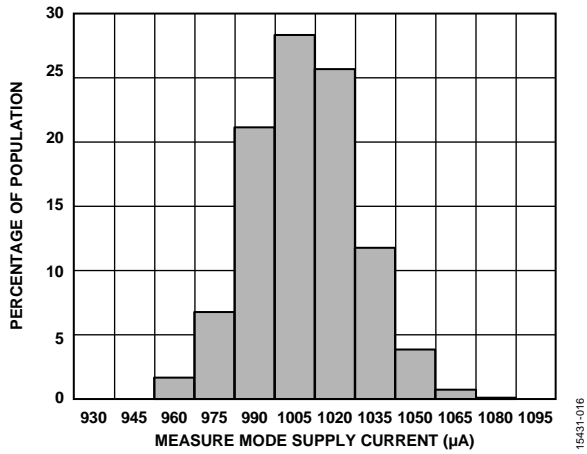

Figure 16. ADXL1001/ADXL1002 Measure Mode Supply Current Histogram at 5 V

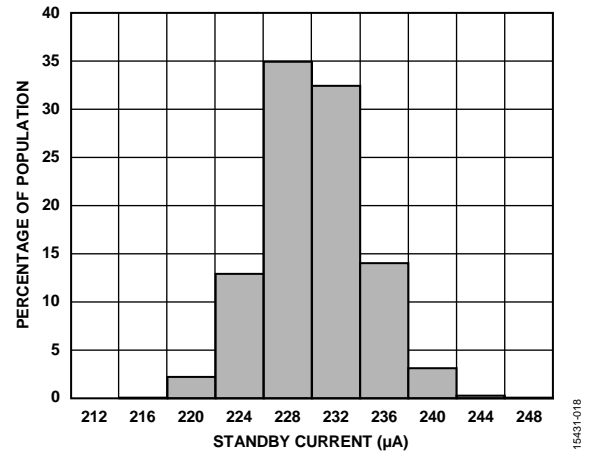

Figure 19. ADXL1001/ADXL1002 Standby Current Histogram at 5 V

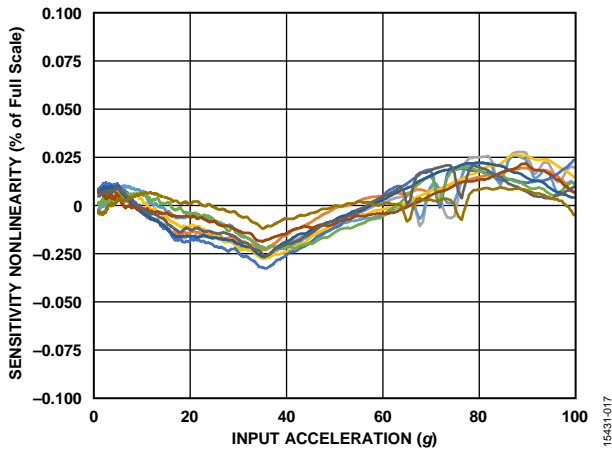

Figure 17. ADXL1001 Sensitivity Nonlinearity vs. Input Acceleration

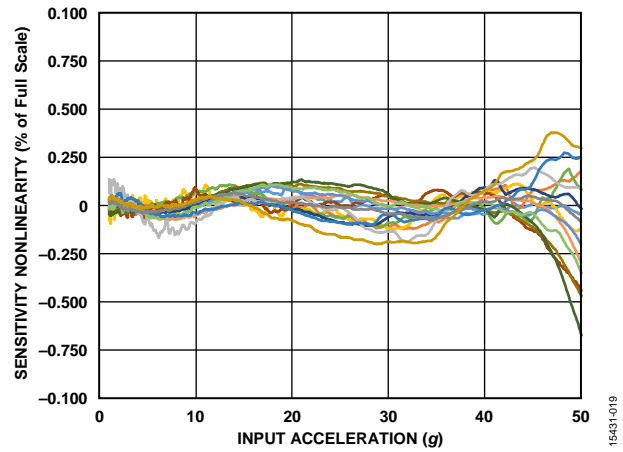

Figure 20. ADXL1002 Sensitivity Nonlinearity vs. Input Acceleration

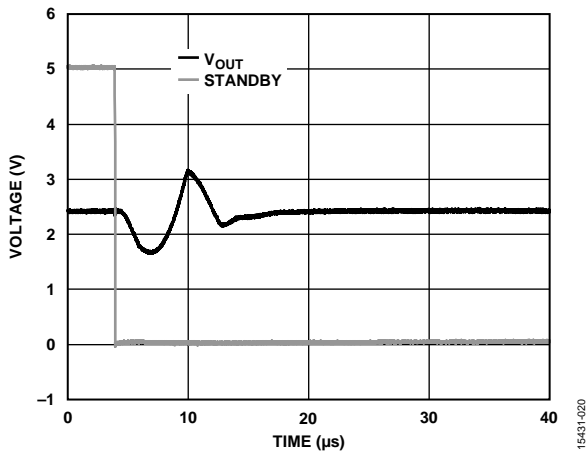

Figure 18. ADXL1001/ADXL1002 Output (Gray Trace) Settling in Standby (Black); Output Voltage Settles to Midrail (2.5 V) in Standby in  $<30 \mu s$ ; Effectively Unfiltered (No Low-Pass Filter) Output

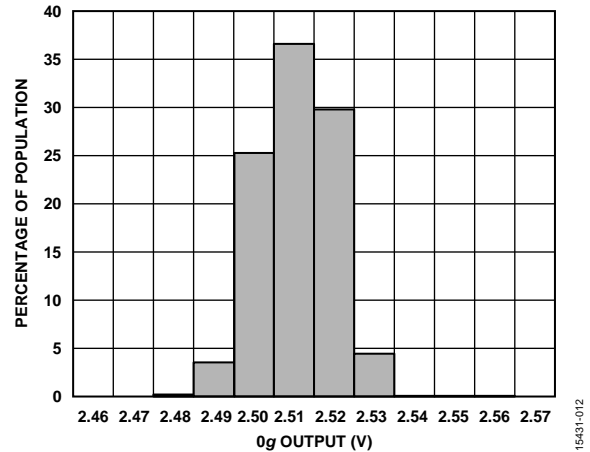

Figure 21. ADXL1001/ADXL1002 0 g Output Population



## THEORY OF OPERATION

The [ADXL1001/ADXL1002](#) are high frequency, low noise single-axis microelectromechanical systems (MEMS) accelerometers that provide an analog output that is proportional to mechanical vibration. The [ADXL1001/ADXL1002](#) have high  $g$  ranges of 100  $g$  and 50  $g$  and are suitable for vibration measurements in high bandwidth applications such as vibration analysis systems that monitor and diagnose machine or system health.

The low noise and high frequency bandwidth allows the measurement of vibration patterns caused by small moving parts, such as internal bearings, and the high  $g$  range provides the dynamic range to be used in high vibration environments such as heating, ventilation, and air conditioning (HVAC) and heavy machine equipment. To achieve proper performance, be aware of system noise, mounting, and signal conditioning.

System noise is affected by supply voltage noise. The analog output of the [ADXL1001/ADXL1002](#) is a ratiometric output; therefore, supply voltage modulation affects the output. Use a properly decoupled stable supply voltage to power the [ADXL1001/ADXL1002](#) and to provide a reference voltage for the digitizing system.

The output signal is impacted by an overrange stimulus. An overload indicator output feature is provided to indicate a condition that is critical for an intelligent measurement system. For more information about the overrange features, see the Overrange section.

Proper mounting is required to ensure full mechanical transfer of vibration to accurately measure the desired vibration rather than vibration of the measurement system, including the sensor. A common technique for high frequency mechanical coupling is to utilize a sensor stud mount system while considering the mechanical interface of fixing the [ADXL1001/ADXL1002](#) in the stud. For lower frequencies (below the full capable bandwidth of the sensor), it is possible to use magnetic or adhesive mounting. Proper mounting technique ensures proper and repeatable results that are not influenced by measurement system mechanical resonances and/or damping at the desired frequency, and represents an efficient and proper mechanical transfer to the system being monitored.

Proper application specific signal conditioning is required to achieve optimal results. An understanding of measurement frequency range and managing overload condition is important to achieve accurate results. The electrical output signal of the [ADXL1001/ADXL1002](#) requires some band limiting and proper digitization bandwidth. See the Interfacing Analog Output Below 10 kHz section and the Interfacing Analog Output Beyond 10 kHz section for more information.

## MECHANICAL DEVICE OPERATION

The moving component of the sensor is a polysilicon surface-micromachined structure built on top of a silicon wafer. Polysilicon springs suspend the structure over the surface of the wafer and provide a resistance against acceleration forces.

Deflection of the structure is measured using differential capacitors that consist of independent fixed plates and plates attached to the moving mass. Acceleration deflects the structure and unbalances the differential capacitor, resulting in a sensor output with an amplitude proportional to acceleration. Phase-sensitive demodulation determines the magnitude and polarity of the acceleration.

## OPERATING MODES

The [ADXL1001/ADXL1002](#) have two operating modes: measurement mode and standby mode. Measurement mode provides a continuous analog output for active monitoring. Standby mode is a nonoperational, low power mode.

### Measurement Mode

Measurement mode is the normal operating mode of the [ADXL1001/ADXL1002](#). In this mode, the accelerometer actively measures acceleration along the axis of sensitivity and consumes 1.0 mA (typical) using a 5.0 V supply.

### Standby

Placing the [ADXL1001/ADXL1002](#) in standby mode suspends the measurement with internal reduction of current consumption to 225  $\mu$ A (typical for 5.0 V supply). The transition time from standby to measurement mode is  $<50$   $\mu$ s. The transition from standby to measure mode is shown in Figure 18.

## BANDWIDTH

The [ADXL1001/ADXL1002](#) circuitry supports an output signal bandwidth beyond the resonant frequency of the sensor, measuring acceleration over a bandwidth comparable to the resonant frequency of the sensor. The output response is a combination of the sensor response and the output amplifier response. Therefore, external band limiting or filtering is required; see the Interfacing Analog Output Below 10 kHz section and the Interfacing Analog Output Beyond 10 kHz section for more information.

When using the [ADXL1001/ADXL1002](#) beyond 10 kHz, consider the nonlinearity due to the resonance frequency of the sensor, the additional noise due to the wideband output of the amplifier, and the discrete frequency spurious tone due to coupling of the internal 200 kHz clock. Aliased interferers in the desired band cannot be removed, and observed performance degrades. A combination of high speed sampling and appropriate band limiting filtering is required for optimal performance.

## APPLICATIONS INFORMATION

### APPLICATION CIRCUIT

For most applications, a single 1  $\mu\text{F}$  capacitor adequately decouples the accelerometer from noise on the power supply. A band limiting filter at the output provides suppression of out of band noise and signal. A capacitive load between 100 pF and 22 nF is recommended.

The output amplifier can drive resistive loads up to 2 mA of source current, for example greater than 2.5 k $\Omega$  for 5 V operation. If the output is to drive a capacitive load greater than or equal to 100 pF, a series resistor of at least 8 k $\Omega$  is required to maintain the amplifier stability.

When inactive, the ST and STANDBY pins are forced low. The overrange indicator is an output that can be monitored to identify the status of the system.



Figure 22. ADXL1001/ADXL1002 Application Circuit

### ON DEMAND SELF TEST

A fully integrated electromechanical self test function is designed into the ADXL1001/ADXL1002. This function electrostatically actuates the accelerometer proof mass, resulting in a displacement of the capacitive sense fingers. This displacement is equivalent to the displacement that occurs as a result of external acceleration input. The proof mass displacement is processed by the same signal processing circuitry as a true acceleration output signal, providing complete coverage of both the electrical and mechanical responses of the sensor system.

The self test feature can be exercised by the user with the following steps:

1. Measure the output voltage.
2. Turn on self test by setting the ST pin to  $V_{DD}$ .
3. Measure the output again.
4. Subtract the two readings and compare the result to the expected value from Table 1, while factoring in the response curve due to supply voltage, if necessary, from Figure 23.

The self test function can be activated at any point during normal operation by setting the ST pin to  $V_{DD}$ . Self test takes approximately 300  $\mu\text{s}$  from the assertion of the ST pin to a result, and acceleration outputs return approximately 300  $\mu\text{s}$  after the release of the ST pin. While performing the self test measurement, do not use the accelerometer output to measure external acceleration.

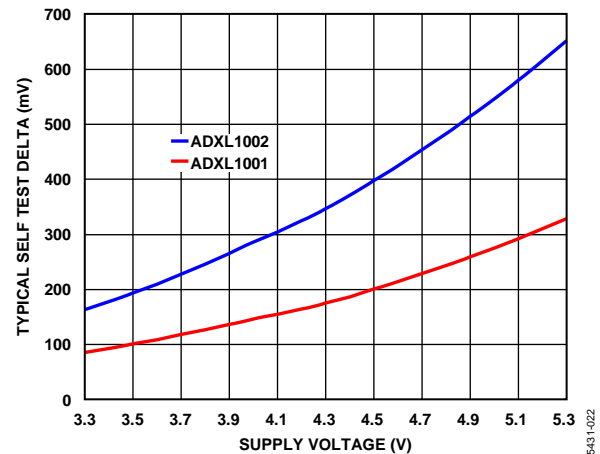

Figure 23. ADXL1002 Typical Self Test Delta vs. Supply Voltage

### RATIOMETRIC OUTPUT VOLTAGE

The ADXL1001/ADXL1002 are tested and specified at  $V_{DD} = 5.0\text{ V}$ ; however, it can be powered with  $V_{DD}$  as low as 3.3 V or as high as 5.25 V. Some performance parameters change as the supply voltage is varied.

The ADXL1001/ADXL1002 output is ratiometric to the supply voltage  $V_{DD}$ ; therefore, the output sensitivity (or scale factor) varies proportionally to the supply voltage. At  $V_{DD} = 5.0\text{ V}$ , the output sensitivity is typically 40 mV/g and 20 mV/g in the ADXL1002 and ADXL1001, respectively.

The zero g bias output is ratiometric also and is nominally midscale relative to the supply voltage ( $V_{DD}/2$ ).



Figure 24. ADXL1002 Sensitivity vs. Supply Voltage

### INTERFACING ANALOG OUTPUT BELOW 10 kHz

The ADXL1001/ADXL1002 sense mechanical motion along a single axis and produces a voltage output. The system performance depends on the output response that is a result of mechanical vibration sensed and signal processing of the electrical output.

The sensor must be effectively mechanically coupled. Mechanical coupling can be a complex integration of multiple components, typically unique for each application. Consideration must be made for all mechanical interfaces including the mounting of the MEMS to the PCB (location on the PCB as well as solder chemistry), the size of the PCB (both thickness and active surface area), and the mounting of the PCB to the system being monitored (either in a module or directly mounted).

In general, the following guidelines for effective mechanical interface must be used to support up to 10 kHz bandwidth:

- Keep the ADXL1001/ADXL1002 near a stable mechanical mounting on the PCB.
- Provide multiple hard mounting points.
- Keep the PCB thick and avoid a large surface area PCB that induces higher magnitude and lower frequency resonances.
- Ensure the mechanical connection is sufficiently stiff to transfer mechanical forces up to the desired frequency. Below 10 kHz, magnetic and adhesive mounting is possible with proper attention. The EVAL-ADXL1001Z and the EVAL-ADXL1002Z evaluation boards can be used as a reference.

The ADXL1001/ADXL1002 electrical output supports a bandwidth beyond the resonance of the sensor. The small signal bandwidth of the output amplifier in the ADXL1001/ADXL1002 is 70 kHz. During the digitization process, aliasing, which is the folding of higher frequency noise and signals into the desired band, can occur. To avoid aliasing noise from the amplifier and other internal circuits (for example, coupling of the internal 200 kHz clock), it is recommended that an external filter be implemented at

the desired bandwidth and the chosen ADC sampling rate be faster than the amplifier bandwidth.

The output amplifier is ratiometric to the supply voltage, and there are two distinct cases regarding digital conversion, as follows:

- The user has an analog-to-digital (ADC) downstream of the accelerometer that can use the  $V_{DD}$  voltage as a reference. In this case, the voltage supply tolerance and voltage temperature coefficient (commonly associated with external regulators) tracks between the sensor and the ADC and, therefore, the supply and reference voltage induced error cancels out. This design approach is recommended.
- If the ADC cannot reference the same 5 V supply as the sensor for any reason, the sensitivity of the digitized sensor output reflects the regulator tolerance and temperature coefficient.

The ADXL1001/ADXL1002 output amplifier is stable while driving capacitive loads up to 100 pF directly without a series resistor. At loads greater than 100 pF, an 8 k $\Omega$  series resistor or greater must be used.

See Figure 25 for an example of the interface including components when measuring mechanical vibration from 0 kHz to 5 kHz, using the AD4000 ADC. For a 5 kHz pass band, a single-pole RC filter is acceptable; however, in some applications, use a more aggressive filter and lower sample rate. The following components are recommended to form a two-pole RC filter at the output of the ADXL1001/ADXL1002: R1 = 91 k $\Omega$ , C1 = 330 pF, R2 = 0  $\Omega$ , and C2 = not required. A minimum ADC sample rate of 16 kHz is recommended to avoid aliasing.

See Figure 25 for an example of the interface including components when measuring mechanical vibration from 0 kHz to 10 kHz. The following components are recommended to form a two-pole RC filter at the output of the ADXL1001/ADXL1002: R1 = 16 k $\Omega$ , C1 = 300 pF, R2 = 32 k $\Omega$ , and C2 = 300 pF. A minimum ADC sample rate of 32 kHz is recommended to avoid aliasing. The two-pole RC filter produces an attenuation of approximately 84 dB at 200 kHz, the internal clock frequency.

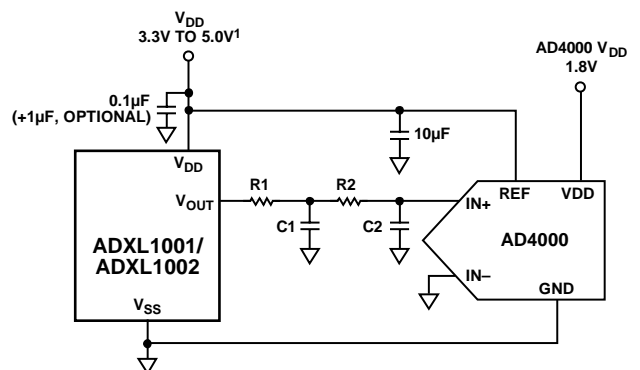

13.3V LIMITED BY ADXL1001/ADXL1002; 5.0V LIMITED BY AD4000

Figure 25. Application Circuit for the ADXL1001/ADXL1002

### INTERFACING ANALOG OUTPUT BEYOND 10 kHz

The [ADXL1001/ADXL1002](#) are high frequency, single-axis MEMS accelerometer devices that provide an output signal pass band beyond the resonance frequency range of the sensor. Although the output 3 dB frequency response bandwidth is approximately 11 kHz (note that this is a 3 dB response, meaning there is a gain in sensitivity at this frequency), in some cases, it is desirable to observe frequency beyond this range. To accommodate this, the [ADXL1001/ADXL1002](#) output amplifier supports a 70 kHz small signal bandwidth, which is well beyond the resonant frequency of the sensor.

Although a mechanical interface is always important to achieve accurate and repeatable results in MEMS applications, it is critical in cases when measuring greater than a few kilohertz. Typically, magnetic and adhesive mounting are not sufficient to maintain proper mechanical transfer of vibration through these frequencies. Mechanical system analysis is required for these applications.

When using the [ADXL1001/ADXL1002](#) beyond 10 kHz, consider the nonlinearity due to the resonance frequency of the sensor, the additional noise due to the wideband output of the amplifier, and the discrete frequency spurious tone due to coupling of the internal 200 kHz clock. If any of these interferers alias in the desired band, it cannot be removed and observed performance degrades. A combination of high speed sampling and appropriate filtering is required for optimal performance.

The first consideration is the effect of the sensor resonance frequency at 21 kHz. Approaching and above this frequency, the output response to an input stimulus peaks, as shown in Figure 4. At frequencies near or above the resonance, the output response is outside the linear response range and, therefore, the sensitivity is different than observed at lower frequencies. In these frequency ranges, the relative response (as opposed to absolute value) over time is typically observed.

The [ADXL1001/ADXL1002](#) output amplifier small signal bandwidth is 70 kHz. The user must properly interface to the device with proper signal filtering to avoid issues with out of band noise aliasing into the desired band. The amplifier frequency response roll off can be modeled as a single-pole, low-pass filter at 70 kHz. In the absence of additional external low-pass filtering, to avoid aliasing of high frequency noise, choose a sampling rate of at least twice the equivalent noise bandwidth (ENBW) for a single-pole, low-pass filter, as follows:

$$ENBW = \frac{\pi}{2} \times 70 \text{ kHz} \approx 110 \text{ kHz}$$

That is, sampling rate must be at least 220 kHz. This sample rate addresses reducing broadband noise due to the amplifier from folding back (aliasing) in-band, but does not prevent out of band signals from aliasing in-band. To prevent out of band responses, additional external low-pass filtering is required.

Another issue that must be addressed is the coupling of the internal clock signal at 200 kHz onto the output signal. This clock spur must be filtered by analog or digital filtering so as not to affect the analysis of results.

For example, to achieve the lowest rms noise and noise density for extended bandwidth applications, it is recommended to use at least a multiple order low-pass filter at the output of the [ADXL1001/ADXL1002](#) and a digitization sample rate of at least 4× the desired bandwidth, assuming sufficient filtering of the 200 kHz internal clock signal. Use an ADC sample rate of 1 MSPS or greater along with digital low-pass filtering to achieve similar performance.

### OVERRANGE

The [ADXL1001/ADXL1002](#) have an output (OR pin) to signal when an overrange event (acceleration larger than twice the full-scale range). Built in overrange detection circuitry provides an alert to indicate a significant overrange event occurred that is greater than approximately 2× the specified g range. When an overrange is detected, the internal clock is disabled to the sensor for 200 μs to maximize protection of the sensor element during an overrange event. If a sustained overrange event is encountered, the overrange detection circuitry triggers periodically, approximately every 500 μs.



Figure 26. [ADXL1001/ADXL1002](#) Behavior During a Continuous Overrange

**MECHANICAL CONSIDERATIONS FOR MOUNTING**

Mount the [ADXL1001/ADXL1002](#) on the PCB in a location close to a hard mounting point of the PCB. Mounting the [ADXL1001/ADXL1002](#) at an unsupported PCB location, as shown in Figure 27, may result in large, apparent measurement errors due to undamped PCB vibration. Placing the accelerometer near a hard mounting point ensures that any PCB vibration at the accelerometer is above the mechanical sensor resonant frequency of the accelerometer and, therefore, effectively invisible to the accelerometer. Multiple mounting points, close to the sensor, and a thicker PCB also help to reduce the effect of system resonance on the performance of the sensor.



Figure 27. Incorrectly Placed Accelerometers

**LAYOUT AND DESIGN RECOMMENDATIONS**

Figure 28 shows the recommended printed circuit board land pattern.



Figure 28. Recommended Printed Wiring Board Land Pattern

OUTLINE DIMENSIONS



\*COMPLIANT TO JEDEC STANDARDS MO-220-VHHD-4 WITH EXCEPTION TO PACKAGE HEIGHT.

Figure 29. 32-Lead Lead Frame Chip Scale Package (LFCSP)  
5 mm × 5 mm Body and 1.8 mm Package Height  
(CP-32-26)  
Dimensions shown in millimeters

ORDERING GUIDE

Model <sup>1</sup>	Temperature Range	g Range	Package Description	Package Option
ADXL1001BCPZ	-40°C to +125°C	±100 g	32-Lead Lead Frame Chip Scale Package [LFCSP]	CP-32-26
ADXL1001BCPZ-RL	-40°C to +125°C	±100 g	32-Lead Lead Frame Chip Scale Package [LFCSP]	CP-32-26
ADXL1001BCPZ-RL7	-40°C to +125°C	±100 g	32-Lead Lead Frame Chip Scale Package [LFCSP]	CP-32-26
ADXL1002BCPZ	-40°C to +125°C	±50 g	32-Lead Lead Frame Chip Scale Package [LFCSP]	CP-32-26
ADXL1002BCPZ-RL	-40°C to +125°C	±50 g	32-Lead Lead Frame Chip Scale Package [LFCSP]	CP-32-26
ADXL1002BCPZ-RL7	-40°C to +125°C	±50 g	32-Lead Lead Frame Chip Scale Package [LFCSP]	CP-32-26
EVAL-ADXL1002Z			ADXL1002 Evaluation Board	
EVAL-ADXL1001Z			ADXL1001 Evaluation Board	

<sup>1</sup> Z = RoHS Compliant Part.

## Данный компонент на территории Российской Федерации

### Вы можете приобрести в компании MosChip.

Для оперативного оформления запроса Вам необходимо перейти по данной ссылке:

<http://moschip.ru/get-element>

Вы можете разместить у нас заказ для любого Вашего проекта, будь то серийное производство или разработка единичного прибора.

В нашем ассортименте представлены ведущие мировые производители активных и пассивных электронных компонентов.

Нашей специализацией является поставка электронной компонентной базы двойного назначения, продукции таких производителей как XILINX, Intel (ex.ALTERA), Vicor, Microchip, Texas Instruments, Analog Devices, Mini-Circuits, Amphenol, Glenair.

Сотрудничество с глобальными дистрибьюторами электронных компонентов, предоставляет возможность заказывать и получать с международных складов практически любой перечень компонентов в оптимальные для Вас сроки.

На всех этапах разработки и производства наши партнеры могут получить квалифицированную поддержку опытных инженеров.

Система менеджмента качества компании отвечает требованиям в соответствии с ГОСТ Р ИСО 9001, ГОСТ РВ 0015-002 и ЭС РД 009

### Офис по работе с юридическими лицами:

105318, г.Москва, ул.Щербаковская д.3, офис 1107, 1118, ДЦ «Щербаковский»

Телефон: +7 495 668-12-70 (многоканальный)

Факс: +7 495 668-12-70 (доб.304)

E-mail: [info@moschip.ru](mailto:info@moschip.ru)

Skype отдела продаж:

moschip.ru

moschip.ru\_4

moschip.ru\_6

moschip.ru\_9