

CBT-90 TE

Thermally Enhanced LED Chipset



Table of Contents

Technology Overview2

Test Specifications2

Ordering Information3

Monochrome Binning Structure4

Monochrome Bin Kits6

Optical and Electrical Characteristics6

Angular Distribution and Spectrum.....9

Thermal Resistance 10

Mechanical Dimensions .. 11

Packaging Information ... 13

Revision History 15

Features:

- Large, monolithic chip with uniform emitting area of 9 mm²
- Wide color gamut available from Red , Green, Blue single color LEDs. White and UV CBT-90 LEDs are also available with the same package format
- Ultra High thermal conductivity package allows operation at up to 27A CW.
- High precision LEDs placement on copper core PCB for easier thermal management and optical integration
- Unencapsulated die with low profile protective window optimizes optical coupling in etendue-limited applications
- Environmentally friendly: RoHS and Halogen compliant

Applications

- Fiber-coupled Illumination
- Architectural and Entertainment Lighting
- Medical Lighting
- Machine Vision
- Microscopy
- Displays and Signage
- General Illumination
- Spot Lighting
- Emergency Vehicle Lighting
- Projection Systems

Technology Overview

Luminus LEDs™ benefit from a suite of innovations in the fields of chip technology, packaging and thermal management. These breakthroughs allow illumination engineers and designers to achieve solutions that are high brightness and high efficiency.

Luminus LED Technology

Luminus' Devices vertical chip LED technology enables large area LED chips with uniform brightness over the entire LED chip surface. The optical power and brightness produced by these large monolithic chips enable solutions which replace arc and halogen lamps where arrays of traditional high power LEDs cannot.

Packaging Technology

Thermal management is critical in high power LED applications. With a thermal resistance from junction to heat sink of 0.5° C/W, Luminus CBT-90 LEDs have the lowest thermal resistance of any LED on the market. This allows the LED to be driven at higher current densities while maintaining a low junction temperature, thereby resulting in brighter solutions and longer lifetimes.

Reliability

Designed from the ground up, Luminus LEDs are one of the most reliable light sources in the world today. Luminus LEDs have passed a rigorous suite of environmental and mechanical stress tests, including mechanical shock, vibration, temperature cycling and humidity, and have been fully qualified for use in extreme high power and high current applications. With very low failure rates and median lifetimes that typically exceed 60,000 hours, Luminus LEDs are ready for even the most demanding applications.

Environmental Benefits

Luminus LEDs help reduce power consumption and the amount of hazardous waste entering the environment. All LED products manufactured by Luminus are RoHS compliant and free of hazardous materials, including lead and mercury.

Understanding Luminus LED Test Specifications

Every Luminus LED is fully tested to ensure that it meets the high quality standards expected from Luminus' products.

Testing of Luminus LEDs

Luminus core board products are typically measured in such a way that the characteristics reported agree with how the devices will actually perform when incorporated into a system. This measurement is accomplished by mounting the devices on a 40°C heat sink and allowing the device to reach thermal equilibrium while fully powered. Only after the device reaches equilibrium are the measurements taken. This method of measurement ensures that Luminus LEDs perform in the field just as they are specified.

Expected flux values in real world operation can be extrapolated based on the information contained within this product data sheet.

CBT-90 Monochromatic Binning Structure

All CBT-90 monochromatic LEDs are tested for luminous flux/ dominant wavelength and placed into one of the following flux/ wave length bins. The binning structure is universally applied across each monochromatic color of the CBT-90 product line.

Flux Bins*

Color	Luminous Flux Bin (FF)	Minumum Flux (lm) @ 13.5A	Maximum Flux (lm) @ 13.5A	Min Power (Watts) @ 13.5A	Max Power (Watts) @ 13.5A
Red	BM	770	970		
	BN	970	1150		
	BP	1150	1350		
	BQ	1350	1570		
Green	CK	1,500	2,000		
	CM	2,000	2,300		
	CN	2,300	2,600		
Blue	G			8.3	9.1
	H			9.1	10.0
	J			10.0	11.0
	K			11.0	12.1

Wavelength Bins

Color	Wavelength Bin	Minumum Wavelength @ 13.5A	Maximum Wavelength @ 13.5A
Red (Dominant WL)	R2	611	615
	R3	615	619
	R4	619	623
	R5	623	627
	R6	627	631
Green (Dominant WL)	G2	510	515
	G3	515	520
	G4	520	525
	G5	525	530
	G6	530	535
	G7	535	540
Blue (Peak WL)	445	445	450
	450	450	455
	455	455	460
	460	460	465
	465	465	470

*Note: Luminus maintains a +/- 6% tolerance on flux measurements.

Ordering Information

Ordering Part Number ^{1,2,3}	Color	Description
CBT-90-RX-L15-BM100	Red	Red LED™ CBT-90 consisting of 9 mm ² LED, thermistor, and connector mounted on a copper-core PCB.
CBT-90-G-L11-CK100	Green	Green LED™ CBT-90 consisting of 9 mm ² LED, thermistor, and connector mounted on a copper-core PCB.
CBT-90-B-L11-G100	Blue	Blue CBT-90 consisting of 9 mm ² LED, thermistor, and connector mounted on a copper-core PCB.

Part Number Nomenclature

CBT — 90 — CC — L## — FF###

Product Family	Chip Area	Color	Package Configuration	Bin Kit ^{1,2,3}
CBT: Copper-core PCB, No Encapsulation	90: 9 mm ²	RX= Red G= Green B= Blue	L15: 28 mm x 26.75 mm - Common Cathode Package L11: 28 mm x 26.75 mm - Common Anode Package See Mechanical Drawing section	See page 5 for complete bin definition table

Note 1: A Bin Kit represents a group of individual flux or power bins that are shippable for a given ordering part number. Individual flux bins are not orderable..

Note 2: Flux Bin listed is minimum bin shipped - higher bins may be included at Luminus' discretion

Note 3: CBT-90-RX-L15-BM100 represents a red CBT-90 Device with a minimum Flux of 770lm and a Dominant Wavelength between 611-631nm
 CBT-90-G-L11-CK100 represents a green CBT-90 Device with a minimum flux of 1500lm and a Dominant Wavelength between 510-540nm
 CBT-90-B-L11-J100 represents a blue CBT-90 Device with a minimum Power of 10Watts and a Peak Wavelength between 445-470nm

CBT-90 Orderable Bin Kits

Color	Luminous Flux		Wavelength Bins	Kit Number
	Min. Flux Bin	Min. Flux/ Power		
Red	BM	770 lm	R2, R3, R4, R5, R6	BM100
			R3, R4, R5	BM101
	BN	970 lm	R2, R3, R4, R5, R6	BN100
			R3,R4,R5	BN101
Green	CK	1,500 lm	G2, G3, G4, G5, G6, G7	CK100
			G4, G5, G6	CK101
	CM	2,000 lm	G2, G3, G4, G5, G6, G7	CM100
			G4, G5, G6	CM101
Blue	G	8.30 W	445,450,455,460,465	G100
			450,455,460	G101
	H	9.10 W	445,450,455,460,465	H100
			450,455,460	H101
	J	10.0 W	445,450,455,460,465	J100
			450,455,460	J101

Optical & Electrical Characteristics

Typical Device Performance

General Characteristics		Symbol	Red ⁸	Green	Blue	Unit
Emitting Area			9.0	9.0	9.0	mm ²
Emitting Area Dimensions			3.0x3.0	3.0x3.0	3.0x3.0	mm x mm
Characteristics at Recommended Test Drive Current, I_f ^{1,2,3}						
Reference Duty Cycle			100	100	100	%
Test Peak Drive Current	typ	I_F	13.5	13.5	13.5	A
Peak Luminous Flux ^{4,5,6}	typ	Φ_v	1,030	2,100	500	lm
Peak Radiometric Flux ^{4,5,6}	typ	Φ_r	5.3	4.4	10.3	W
Dominant Wavelength ⁴	typ	λ_d	620	527	460	nm
Peak Wavelength ⁴	typ	λ_d	631	520	456	nm
FWHM- Spectral bandwidth at 50% of Φ_v ⁴	typ		17	35	21	nm
Chromaticity Coordinates ⁷	typ	x	.694	.173	.146	
	typ	y	.306	.712	.035	
Forward Voltage	min	V_{Fmin}	2	2.9	2.9	V
	typ	V_F	2.8	4.5	3.5	V
	max	V_{Fmax}	3.8	5.5	4.8	V
Dynamic Resistance	typ	Ω_{dyn}	0.03	0.05	0.02	Ω
Device Thermal Characteristics						
Thermal Coefficient of Photometric Flux	typ		-1	-0.2	-0	% / °C
Thermal Coefficient of Radiometric Flux	typ		-0.7	-0.2	-0.2	% / °C
Forward Voltage Temperature Coefficient	typ		-1.6	-2	-3	mV/ °C

Optical & Electrical Characteristics

Absolute Maximum Ratings

	Symbol	Red	Green	Blue	Unit
Absolute Minimum Current (CW or Pulsed) ^{8,9}		0.2	0.2	0.2	A
Absolute Maximum Current (CW) ¹⁰		27	27	27	A
Absolute Maximum Surge Current ¹⁰ (Frequency > 240 Hz, duty cycle =10%, t=1ms)		31.5	31.5	31.5	A
Absolute Maximum Junction Temperature ¹⁰	T _{jmax}	125	150	150	°C
Storage Temperature Range		-40/+100	-40/+100	-40/+100	°C

Note 1: All ratings are based on operation with a constant heat sink temperature $T_{hs} = 40^{\circ}\text{C}$. See Thermal Resistance section for T_{hs} definition.

Note 2: CBT-90 RGB devices can be driven at currents ranging from 200mA to 27A and at duty cycles ranging from 1% to 100%. Drive current and duty cycle should be adjusted as necessary to maintain the junction temperature desired to meet application lifetime requirements. In pulsed operation, rise time from 10-90% of forward current should be larger than 0.5 microseconds.

Note 3: Tested at Current Density of 1.5 A/mm².

Note 4: Unless otherwise noted, values listed are typical. Devices are production tested and specified at 13.5 A.

Note 5: Total flux from emitting area at listed dominant wavelength. Reported performance is included to show trends for a selected power level. For specific minimum and maximum values, use bin tables. For product roadmap and future performance of devices, contact Luminus.

Note 6: Caution must be taken not to stare at the light emitted from these LEDs. Under special circumstances, the high intensity could damage the eye.

Note 7: In CIE 1931 chromaticity diagram coordinates, normalized to $X+Y+Z=1$.

Note 8: For reference only.

Note 9: Special design considerations must be observed for operation under 1 A. Please contact Luminus for further information.

Note 10: CBT-90 RGB LEDs are designed for operation to an absolute maximum current and temperature as specified above. Product lifetime data is specified at recommended forward drive currents. Sustained operation at or beyond absolute maximum currents or temperatures will result in a reduction of device life time compared to recommended conditions. Refer to the lifetime derating curves for further information.

Optical & Electrical Characteristics

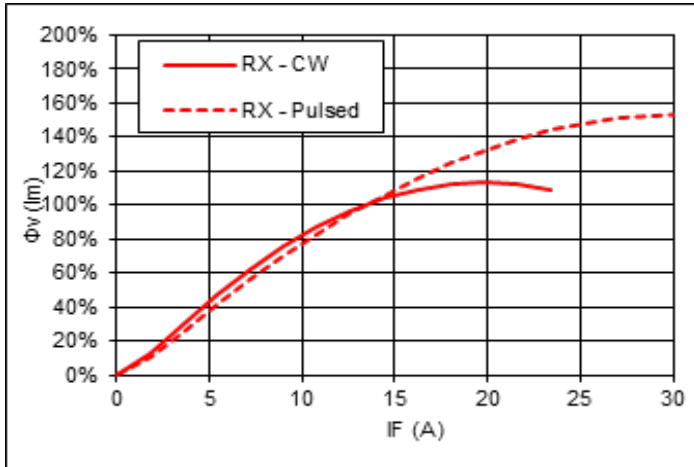
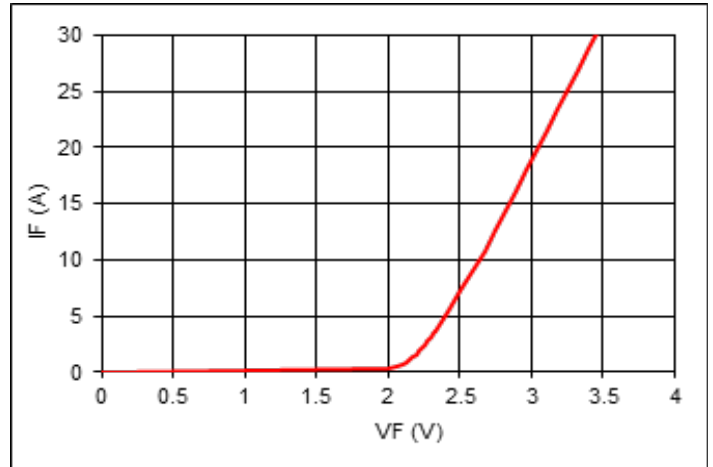
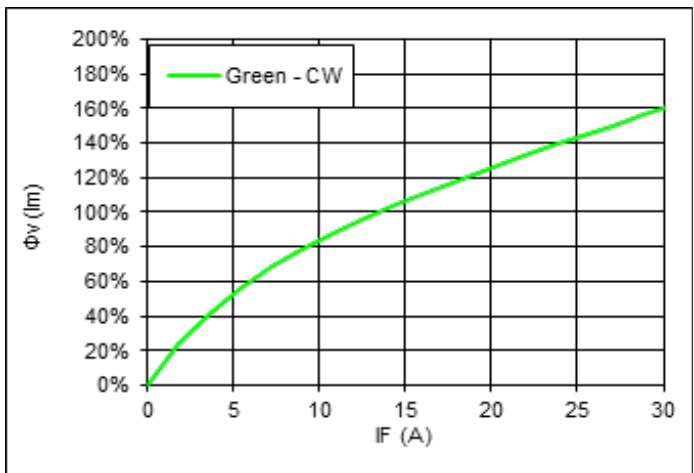
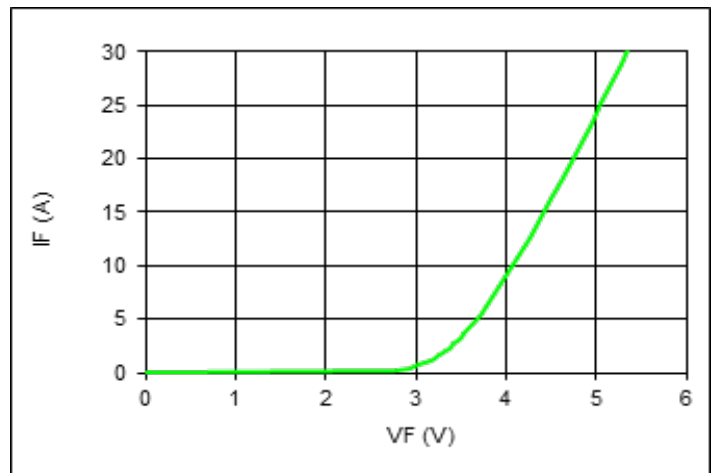
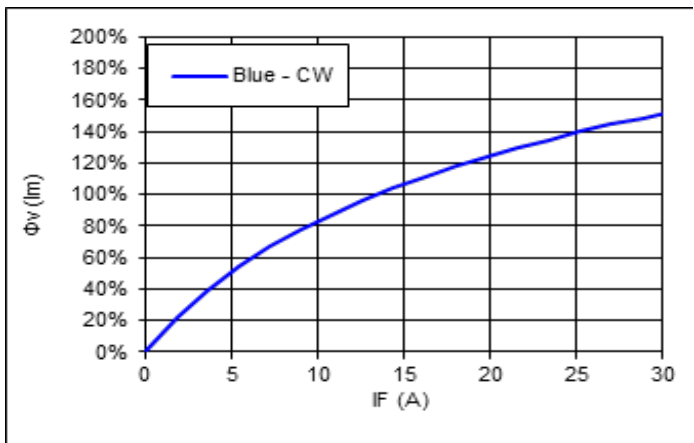
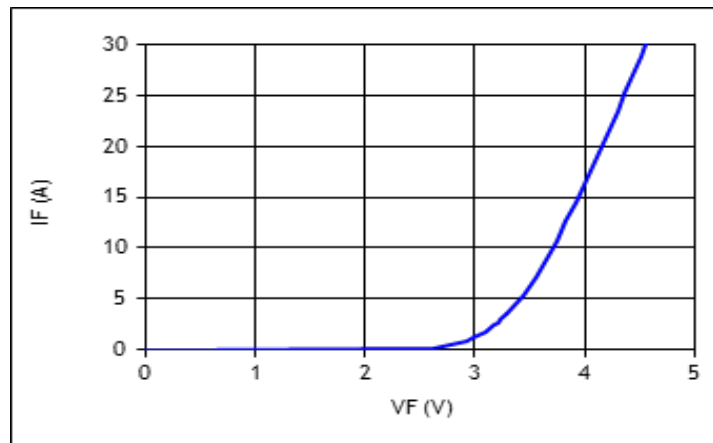
Relative Output Flux vs. Forward Current¹

Forward Current vs. Forward Voltage

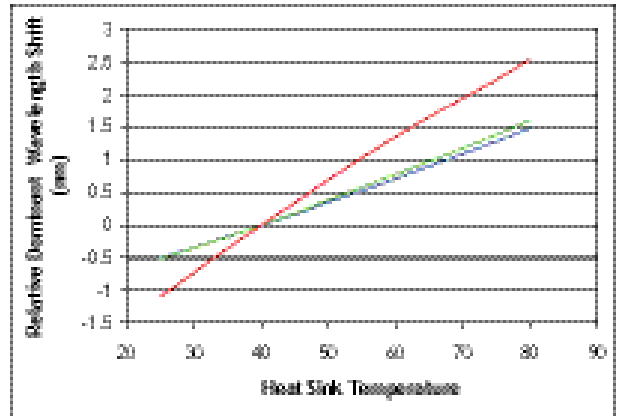
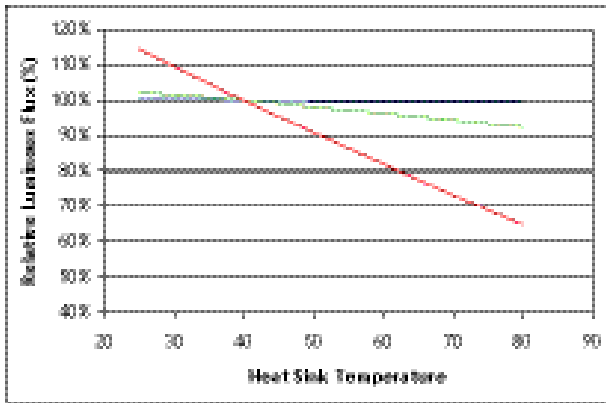
Relative Output Flux vs. Forward Current¹

Forward Current vs. Forward Voltage

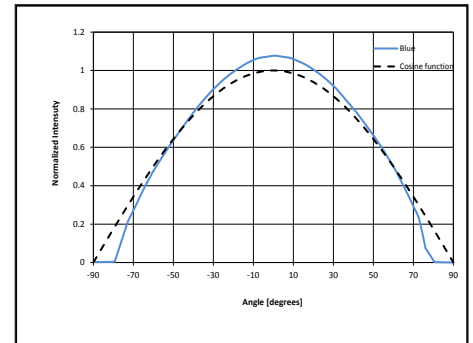
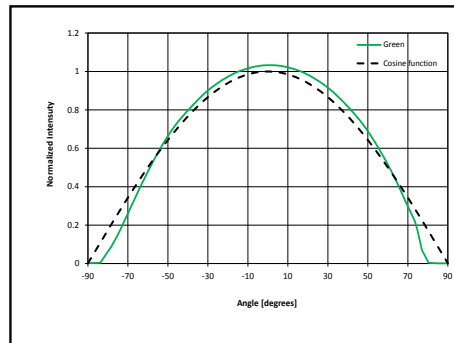
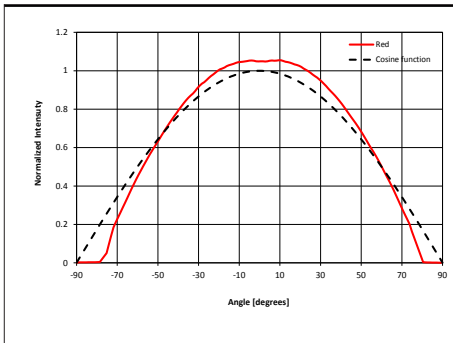
Relative Output Flux vs. Forward Current¹

Forward Current vs. Forward Voltage

Light Output and Spectral Characteristics Over Heat Sink Temperature



Angular Intensity Distribution (Typical)



Typical Spectrum¹

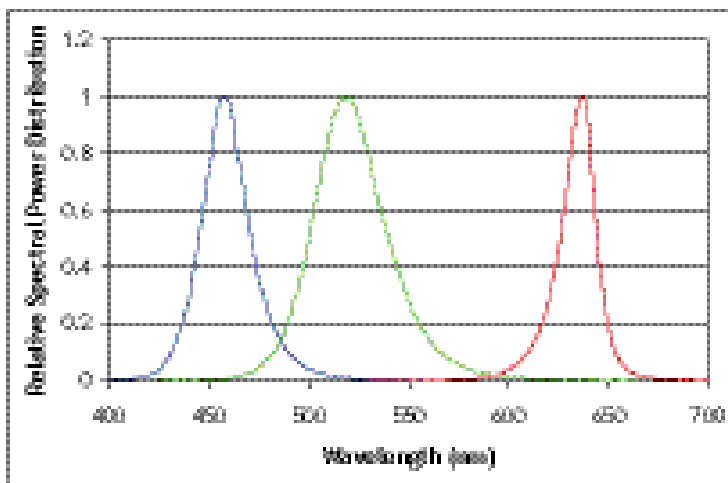

Note 1: Typical spectrum at current density of 0.35 A/mm² in continuous operation.

Thermal Resistance

Typical Thermal Resistance

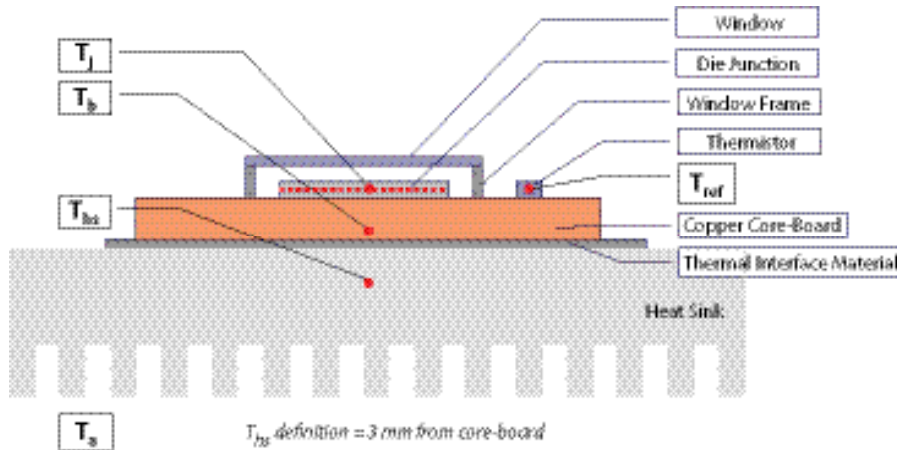

$R_{\theta j-b}^{-1}$	0.5 °C/W
$R_{\theta b-hs}^{-1}$	0.1 °C/W
$R_{\theta j-hs}^{-2}$	0.6 °C/W
$R_{\theta j-ref}^{-1}$	0.5 °C/W

Note 1: Thermal resistance values are based on FEA model results correlated to measured $R_{\theta j-hs}$ data.

Note 2: Thermal resistance is measured using eGraf 1205 thermal interface material.

Thermistor Information

The thermistor used in CBT-90 LEDs mounted on core-boards is from Murata Manufacturing Co. The global part number is NCP15XH103J03RC. Please see <http://www.murata.com/> for details on calculating thermistor temperature.

Electrical Pinout

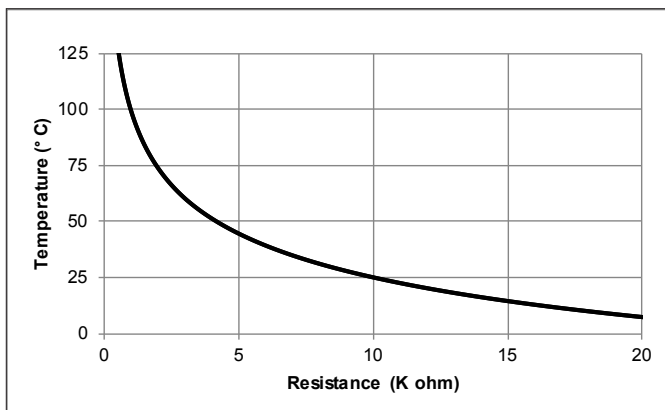
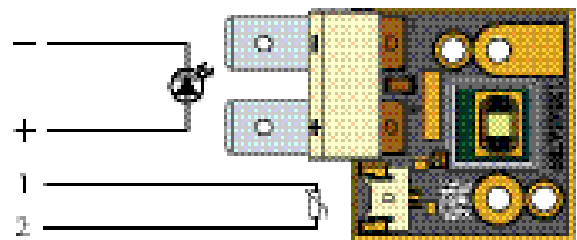

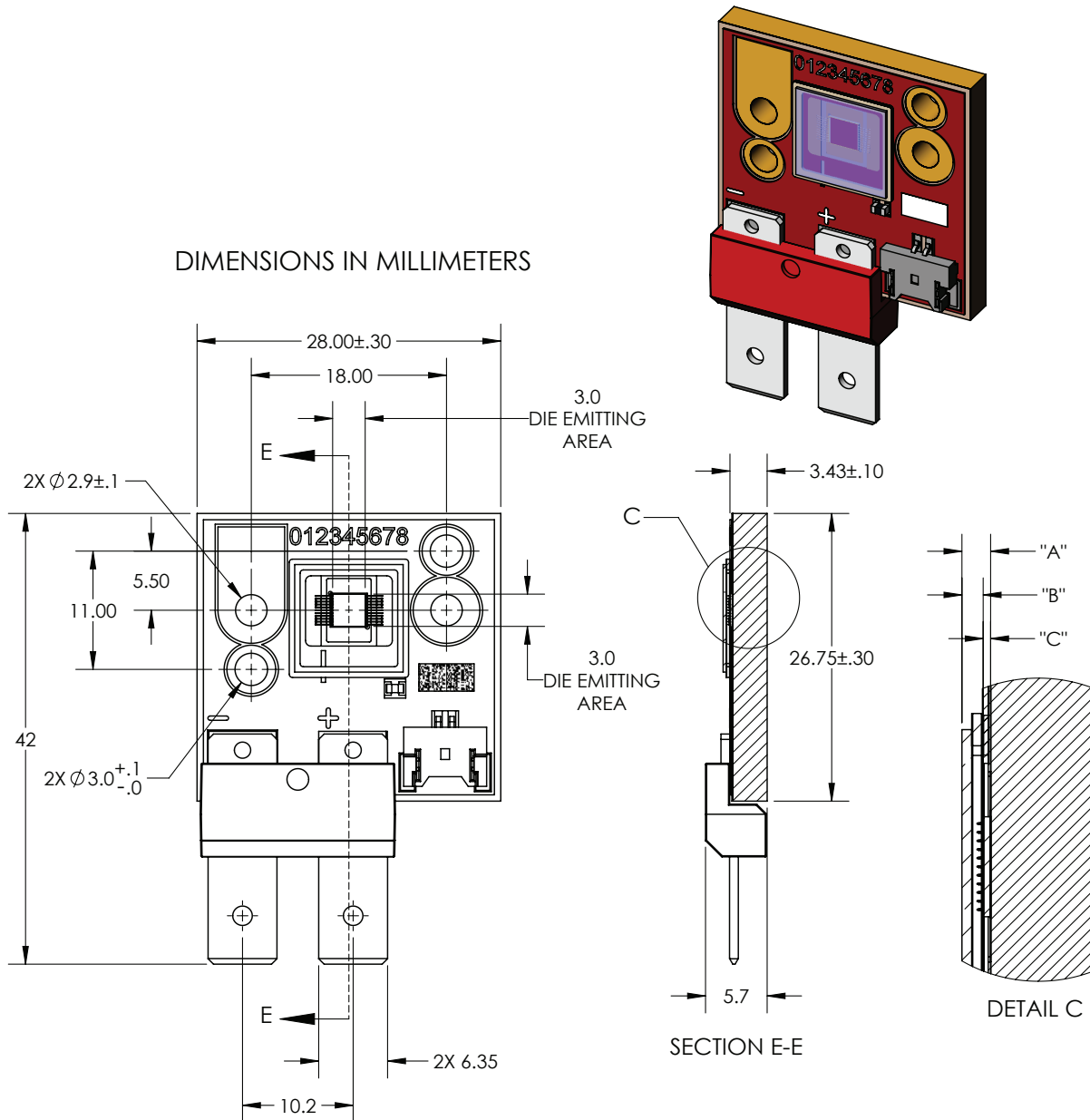
Mechanical Dimensions – CBT-90-RX Common Cathode LED

DIMENSION NAME	DESCRIPTION	NOMINAL DIMENSION	TOLERANCE
"A"	TOP OF METAL SUBSTRATE TO TOP OF WINDOW	.88	±.13
"B"	TOP OF DIE EMITTING AREA TO TOP OF WINDOW	.65	±.11
"C"	TOP OF METAL SUBSTRATE TO TOP OF DIE EMITTING AREA	.23	±.02

DWG-002506

Recommended connector for Anode and Cathode: Panduit Disco Lok™ Series P/N: DNG14-250FL-C

Thermistor Connector: MOLEX P/N 53780-0270 or GCT P/N WTB08-021S-F.

Recommended Female: MOLEX P/N 51146-0200, GCT P/N WTB06-021S-F or equivalent

For detailed drawing please refer to DWG-002506 document

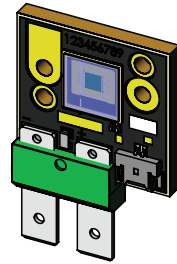
Mechanical Dimensions – CBT-90-G,B Common Anode LED

GREEN LED DEVICE

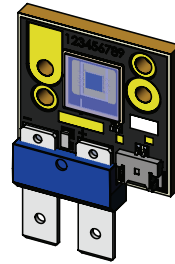

BLUE LED DEVICE

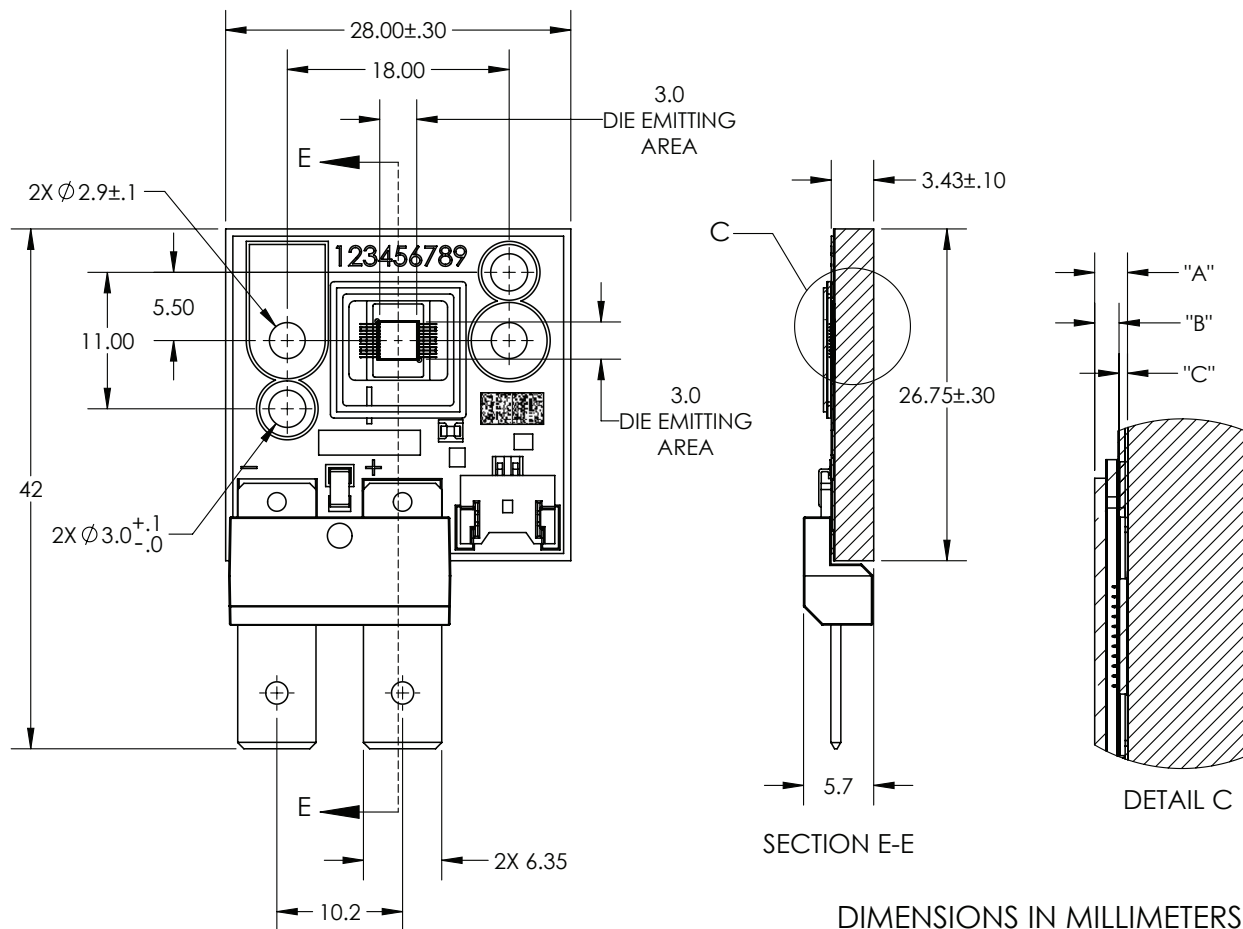

DIMENSION NAME	DESCRIPTION	NOMINAL DIMENSION	TOLERANCE
"A"	TOP OF METAL SUBSTRATE TO TOP OF WINDOW	.88	±.13
"B"	TOP OF DIE EMITTING AREA TO TOP OF WINDOW	.65	±.11
"C"	TOP OF METAL SUBSTRATE TO TOP OF DIE EMITTING AREA	.23	±.02

Recommended connector for Anode and Cathode: Panduit Disco Lok™ Series P/N: DNG14-250FL-C

DWG-002309

Thermistor Connector: MOLEX P/N 53780-0270 or GCT P/N WTB08-0215-F.

Recommended Female: MOLEX P/N 51146-0200, GCT P/N WTB06-0215-F or equivalent

For detailed drawing please refer to DWG-002309 document

Shipping Tray Outline

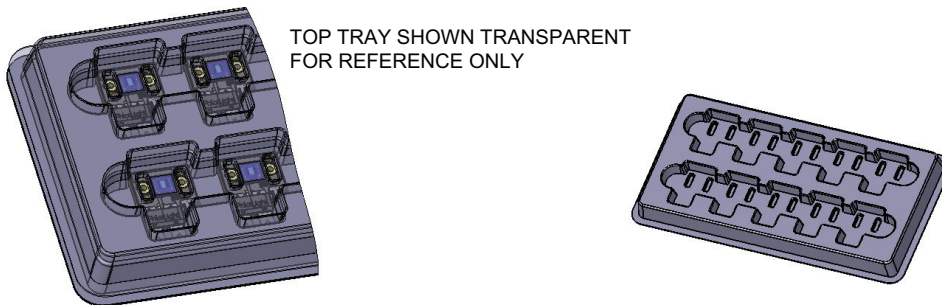
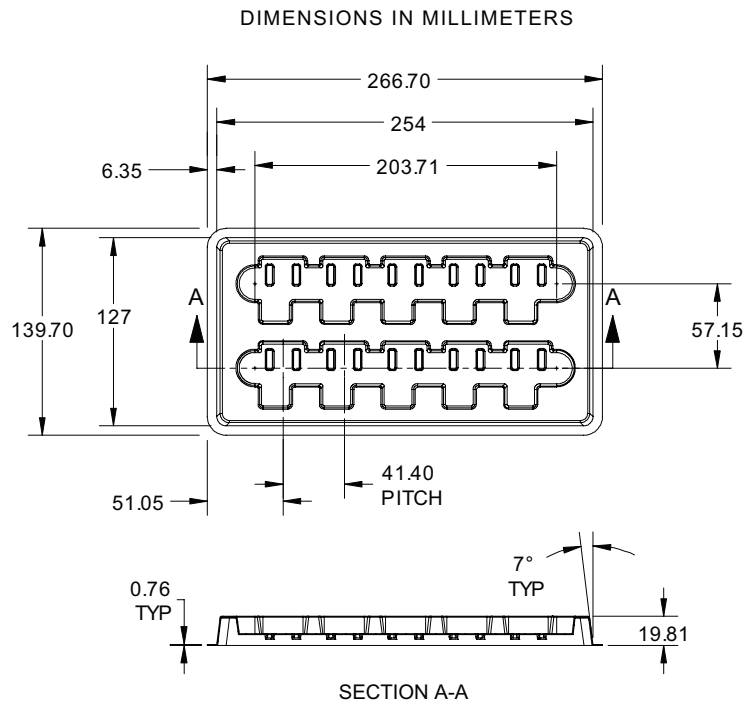

For detailed drawing of shipping trays, please refer to document TO-0479, available upon request.

Packing and Shipping Specification (CBT-90)

Packing Specification

Packing Configuration	Qty /Pack	Reel Dimensions (diameter x W, mm)	Gross Weight (kg)
Stack of 5 trays with 10 devices per tray Each pack is enclosed in ESD bag	50	150 x 280 x 85	2.7

Product Label Specification

Label Fields (subject to change):

- 6-8 digit Box number (for Luminus internal use)
- Luminus ordering part number
- Quantity of devices in pack
- Part number revision (for Luminus internal use)
- Customer's part number (optional)
- Bin (FF-WW) as defined page 3
- 2D Bar code





LUMINUS
LEADER IN BIG CHIP LEDS Solid State Filament™

BT-012345

Box number

PT-120-G-L11-MPG

Luminus part number

12345678

Customer part number

5F

Bin

Qty: 50

Rev 01

RoHS Compliant

for traceability peel off label and attach

Sample label – for illustration only

Shipping Box

Shipping Box	Quantity	Material	Dimensions (L x W x H, mm)
Carton Box	1 -20 packs (50 - 1000 Devices)	S4651	560 x 560 x 200



History of Changes

Rev		Description of Change
01	12/01/2015	Initial Release - Preliminary Specifications
02	02/09/2015	Editorial Changes and Update of Blue Bin Kit Offering
03	02/15/2015	Corrected Green Bin Kit Definition
04	06/17/2017	Revised wording in last page; Removed "Preliminary"
05	07/19/2017	Updated Red flux bin

Luminus Devices assumes no liability for errors that may appear in this document, and no liability otherwise arising from the application or use of the product or information contained herein. None of the information provided herein should be considered to be a representation of the fitness or suitability of the product for any particular application or as any other form of warranty. Luminus Devices' product warranties are limited to only such warranties as accompany a purchase contract or purchase order for such products. Nothing herein is to be construed as constituting an additional warranty. No information contained in this publication may be considered as a waiver by Luminus Devices of any intellectual property rights that Luminus Devices may have in such information.

This product is protected by U.S. Patents 6,831,302; 7,074,631; 7,083,993; 7,084,434; 7,098,589; 7,105,861; 7,138,666; 7,166,870; 7,166,871; 7,170,100; 7,196,354; 7,211,831; 7,262,550; 7,274,043; 7,301,271; 7,341,880; 7,344,903; 7,345,416; 7,348,603; 7,388,233; 7,391,059 Patents Pending in the U.S. and other countries.

Данный компонент на территории Российской Федерации

Вы можете приобрести в компании MosChip.

Для оперативного оформления запроса Вам необходимо перейти по данной ссылке:

<http://moschip.ru/get-element>

Вы можете разместить у нас заказ для любого Вашего проекта, будь то серийное производство или разработка единичного прибора.

В нашем ассортименте представлены ведущие мировые производители активных и пассивных электронных компонентов.

Нашей специализацией является поставка электронной компонентной базы двойного назначения, продукции таких производителей как XILINX, Intel (ex.ALTERA), Vicor, Microchip, Texas Instruments, Analog Devices, Mini-Circuits, Amphenol, Glenair.

Сотрудничество с глобальными дистрибьюторами электронных компонентов, предоставляет возможность заказывать и получать с международных складов практически любой перечень компонентов в оптимальные для Вас сроки.

На всех этапах разработки и производства наши партнеры могут получить квалифицированную поддержку опытных инженеров.

Система менеджмента качества компании отвечает требованиям в соответствии с ГОСТ Р ИСО 9001, ГОСТ РВ 0015-002 и ЭС РД 009

Офис по работе с юридическими лицами:

105318, г.Москва, ул.Щербаковская д.3, офис 1107, 1118, ДЦ «Щербаковский»

Телефон: +7 495 668-12-70 (многоканальный)

Факс: +7 495 668-12-70 (доб.304)

E-mail: info@moschip.ru

Skype отдела продаж:

moschip.ru

moschip.ru_4

moschip.ru_6

moschip.ru_9