

## FLORENCE-1R-O

~95° + 30° oval beam

### TECHNICAL SPECIFICATIONS:

Dimensions	285.6 x 19.5 mm
Height	7 mm
Fastening	glue, clips
ROHS compliant	yes ⓘ

### MATERIAL SPECIFICATIONS:

Component	Type	Material	Colour	Finish
FLORENCE-1R-O	Linear lens	PMMA	clear	

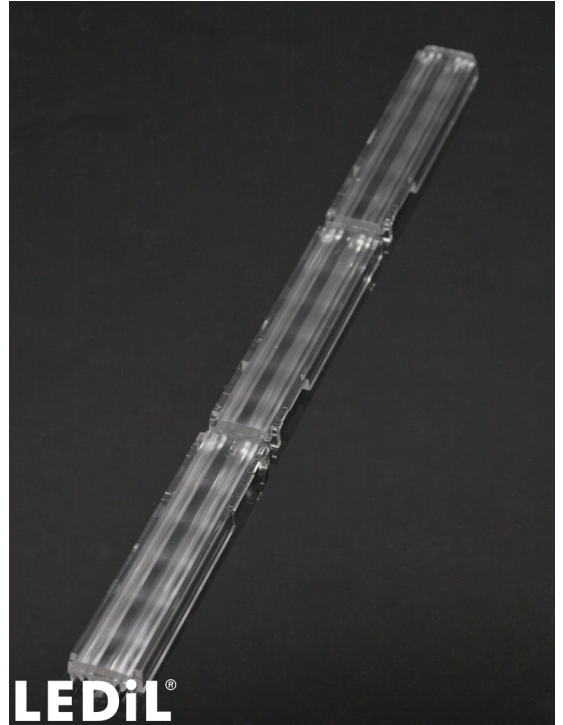

### ORDERING INFORMATION:

Component	Qty in box	MOQ	MPQ	Box weight (kg)
C14454_FLORENCE-1R-O » Box size: 480 x 280 x 300 mm	210	45	15	8.1

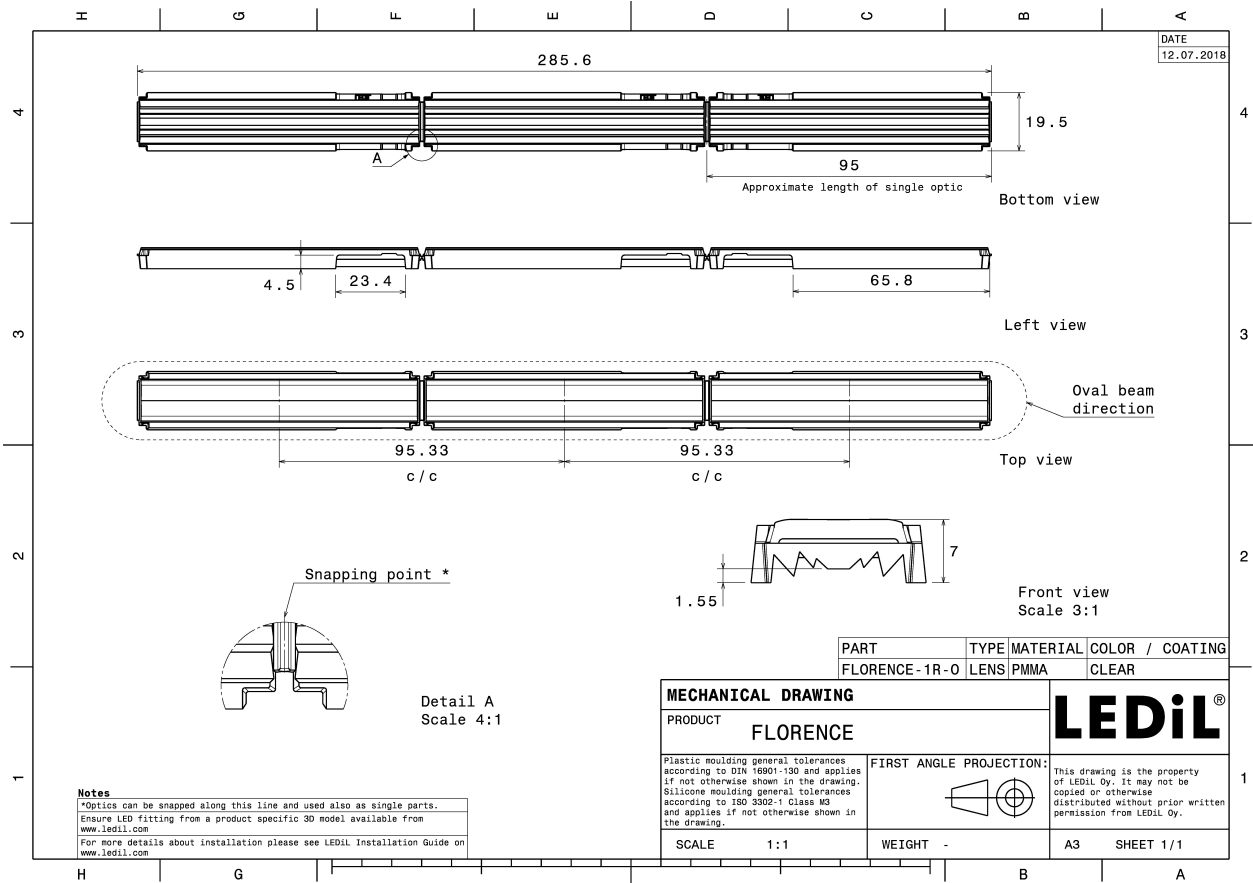

#### PHOTOMETRIC DATA (MEASURED):

#### CEZOS

LED L0-280024-xxx-C0800-L267  
 FWHM 92.0 + 35.0°  
 Efficiency 91 %  
 Peak intensity 0.8 cd/lm  
 LEDs/each optic 1  
 Light colour White  
 Required components:

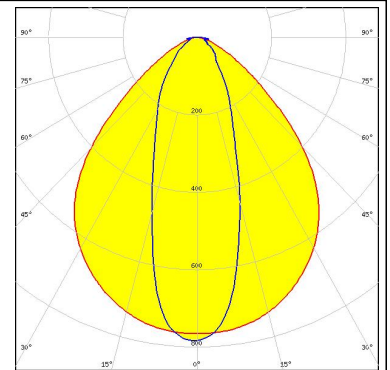
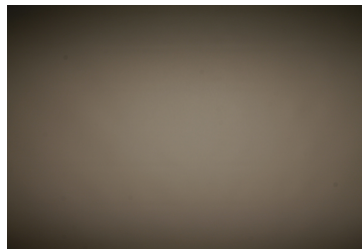

#### LUMILEDS

LED LUXEON 3014  
 FWHM 98.0 + 33.0°  
 Efficiency 93 %  
 Peak intensity 1 cd/lm  
 LEDs/each optic 1  
 Light colour White  
 Required components:

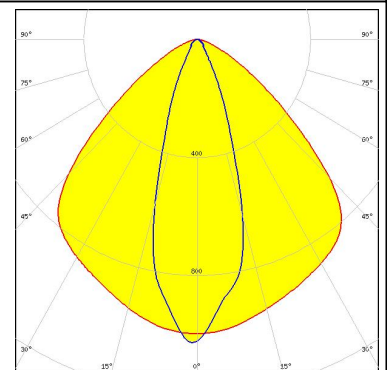
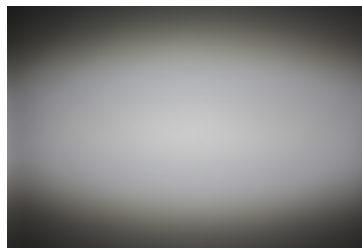

#### LUMILEDS

LED LUXEON 3020  
 FWHM 95.0 + 31.0°  
 Efficiency 93 %  
 Peak intensity 1.1 cd/lm  
 LEDs/each optic 1  
 Light colour White  
 Required components:

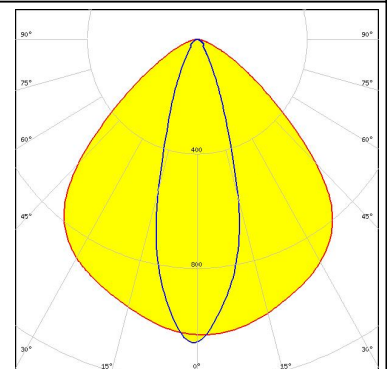
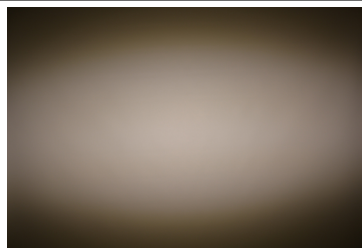

#### LUMILEDS

LED LUXEON 3030 2D (Round LES)  
 FWHM 93.0 + 34.0°  
 Efficiency 91 %  
 Peak intensity 0.9 cd/lm  
 LEDs/each optic 1  
 Light colour White  
 Required components:

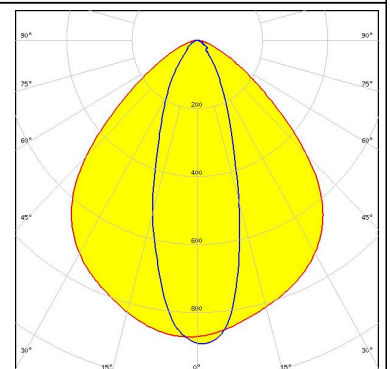
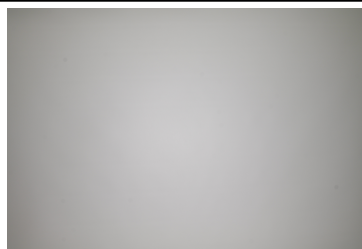

#### PHOTOMETRIC DATA (MEASURED):

##### LUMILEDS

LED LUXEON 3535L  
 FWHM 93.0 + 35.0°  
 Efficiency 93 %  
 Peak intensity 0.9 cd/lm  
 LEDs/each optic 1  
 Light colour White  
 Required components:

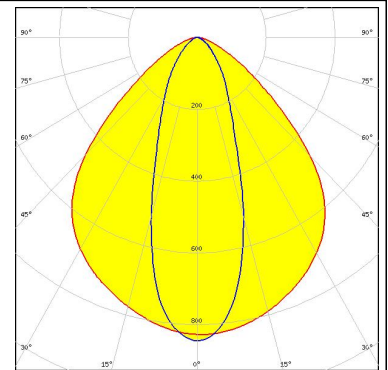
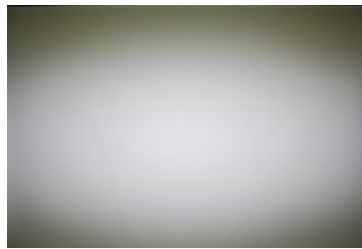

##### LUMINUS

LED MP-2016  
 FWHM 94.0 + 31.0°  
 Efficiency 92 %  
 Peak intensity 1.1 cd/lm  
 LEDs/each optic 1  
 Light colour White  
 Required components:

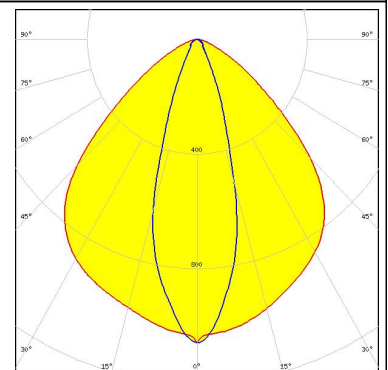
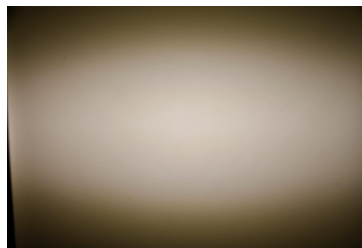

##### NICHIA

LED NF2x757D  
 FWHM 93.0 + 34.0°  
 Efficiency 94 %  
 Peak intensity 0.8 cd/lm  
 LEDs/each optic 1  
 Light colour White  
 Required components:

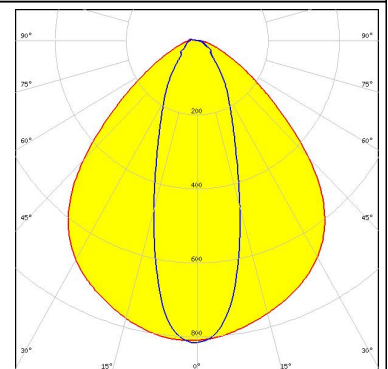
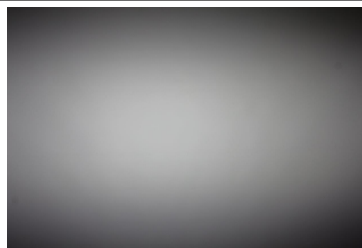

##### NICHIA

LED NF2x757G  
 FWHM 92.0 + 35.0°  
 Efficiency 90 %  
 Peak intensity 0.9 cd/lm  
 LEDs/each optic 1  
 Light colour White  
 Required components:

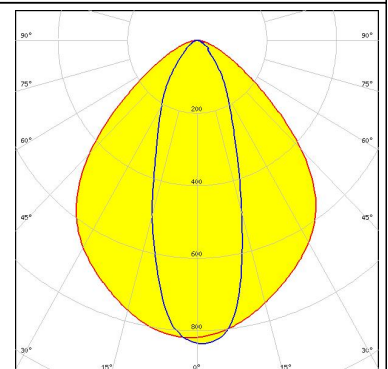
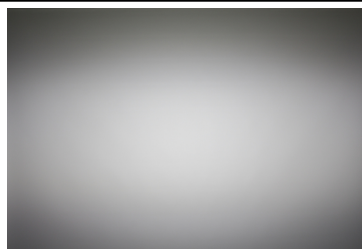

#### PHOTOMETRIC DATA (MEASURED):



**LED** NFSW757H  
**FWHM** 92.0 + 31.0°  
**Efficiency** 94 %  
**Peak intensity** 0.9 cd/lm  
**LEDs/each optic** 1  
**Light colour** White  
**Required components:**  
 C14353\_FLORENCE-1R-CLIP-A

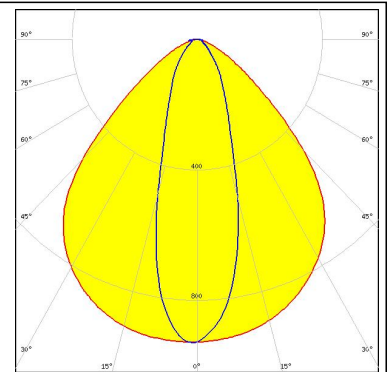

**LED** Duris S5 (2 chip)  
**FWHM** 92.0 + 33.0°  
**Efficiency** 91 %  
**Peak intensity** 0.9 cd/lm  
**LEDs/each optic** 1  
**Light colour** White  
**Required components:**

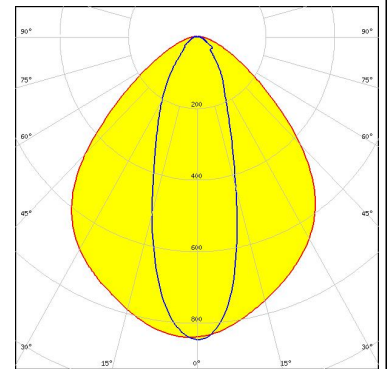

**LED** Fortimo LED Line 1ft 2000lm 1R HV4  
**FWHM** 95.0 + 31.0°  
**Efficiency** 94 %  
**Peak intensity** 0.9 cd/lm  
**LEDs/each optic** 1  
**Light colour** White  
**Required components:**  
 C14353\_FLORENCE-1R-CLIP-A

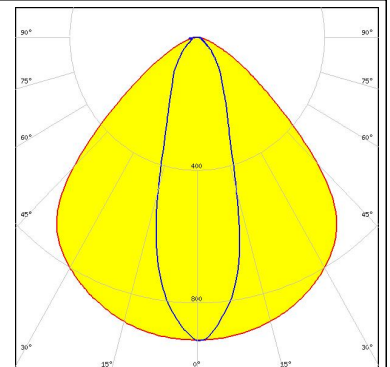
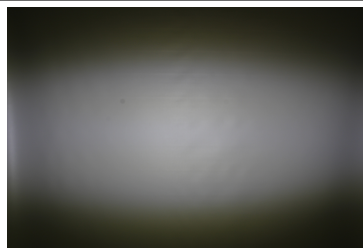

**LED** LM28xB Series  
**FWHM** 94.0 + 34.0°  
**Efficiency** 93 %  
**Peak intensity** 0.9 cd/lm  
**LEDs/each optic** 1  
**Light colour** White  
**Required components:**

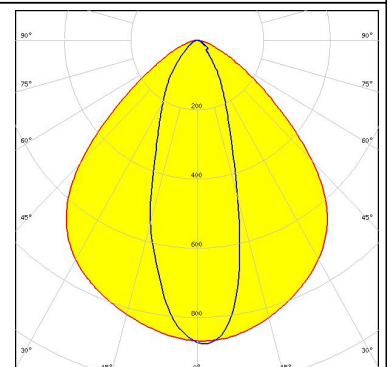
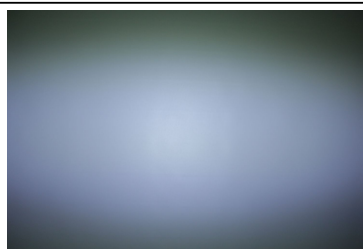

#### PHOTOMETRIC DATA (MEASURED):

#### SAMSUNG

LED LM301A  
 FWHM 93.0 + 32.0°  
 Efficiency 92 %  
 Peak intensity 1 cd/lm  
 LEDs/each optic 1  
 Light colour White  
 Required components:

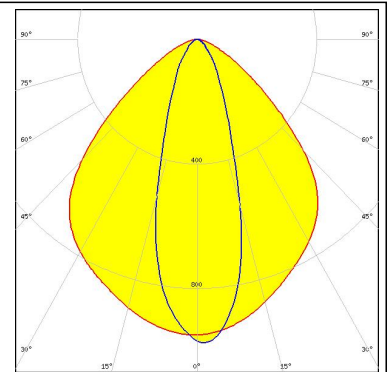

#### SAMSUNG

LED LM302A  
 FWHM 92.0 + 34.0°  
 Efficiency 92 %  
 Peak intensity 0.9 cd/lm  
 LEDs/each optic 1  
 Light colour White  
 Required components:

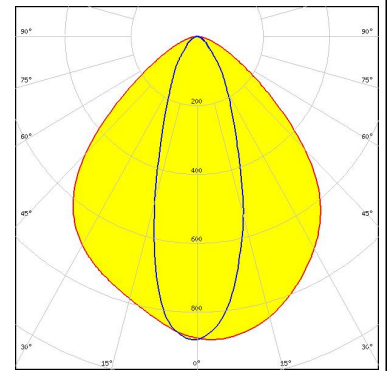

#### SAMSUNG

LED LM561C  
 FWHM 94.0 + 32.0°  
 Efficiency 93 %  
 Peak intensity 0.9 cd/lm  
 LEDs/each optic 1  
 Light colour White  
 Required components:

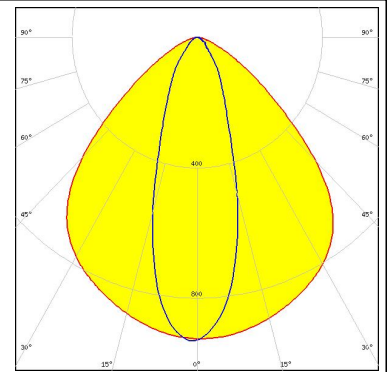
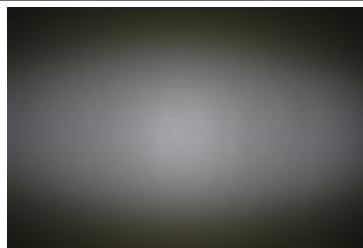

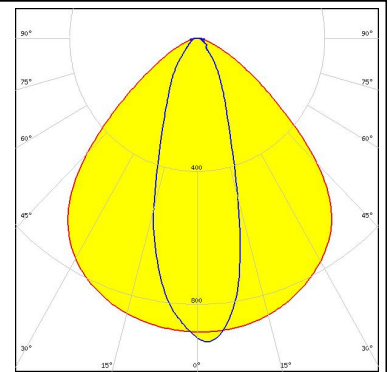
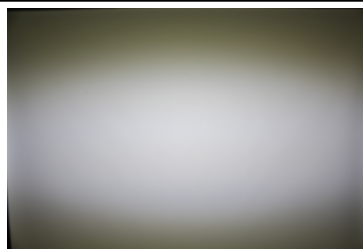

#### SAMSUNG

LED LT-S282N  
 FWHM 95.0 + 32.0°  
 Efficiency 93 %  
 Peak intensity 0.9 cd/lm  
 LEDs/each optic 1  
 Light colour White  
 Required components:

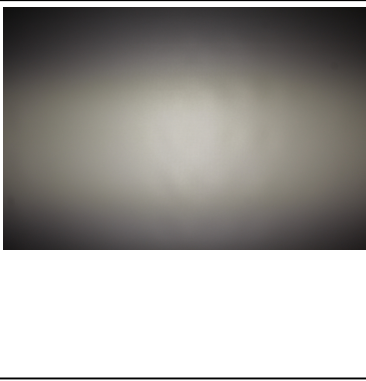
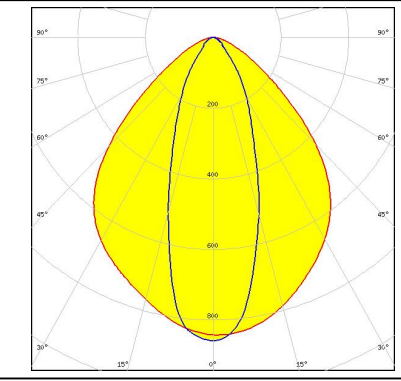

#### PHOTOMETRIC DATA (MEASURED):

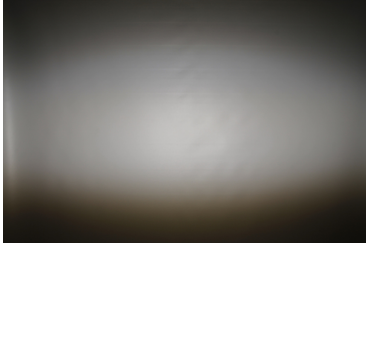
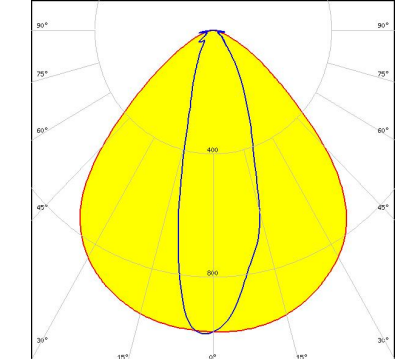
<p> SEOUL SEMICONDUCTOR</p> <p>LED                    SEOUL 3030 FWHM                91.0 + 35.0° Efficiency            90 % Peak intensity       0.9 cd/lm LEDs/each optic    1 Light colour        White Required components:</p>		
<p> SEOUL SEMICONDUCTOR</p> <p>LED                    SEOUL DC 3030 FWHM                92.0 + 30.0° Efficiency            94 % Peak intensity       1 cd/lm LEDs/each optic    1 Light colour        White Required components: C14353_FLORENCE-1R-CLIP-A</p>		

#### PHOTOMETRIC DATA (SIMULATED):



**LED** LUXEON CZ  
**FWHM** 95.0 + 33.0°  
**Efficiency** 94 %  
**Peak intensity** 1.1 cd/lm  
**LEDs/each optic** 1  
**Light colour** White  
**Required components:**

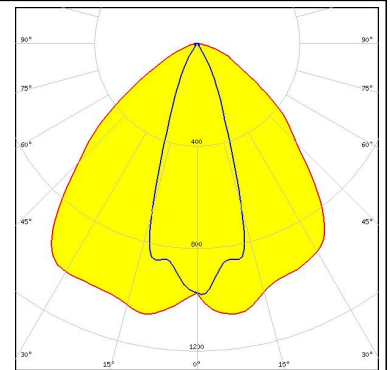

**LED** Duris E 2835  
**FWHM** 92.0 + 30.0°  
**Efficiency** 94 %  
**Peak intensity** 1 cd/lm  
**LEDs/each optic** 1  
**Light colour** White  
**Required components:**

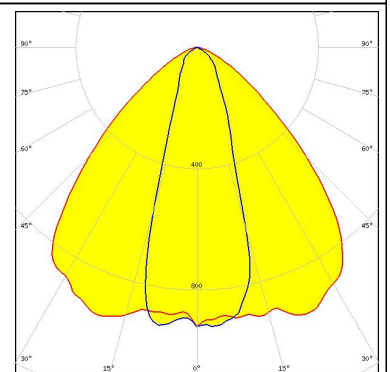

**LED** Duris E5  
**FWHM** 92.0 + 32.0°  
**Efficiency** 94 %  
**Peak intensity** 1 cd/lm  
**LEDs/each optic** 1  
**Light colour** White  
**Required components:**

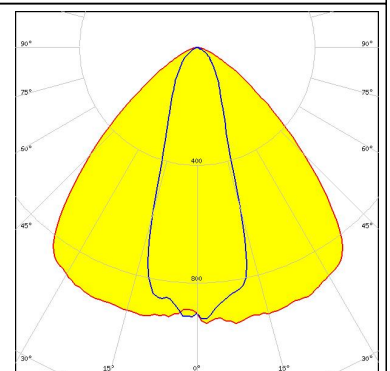

**LED** SEOUL DC 3030C  
**FWHM** 98.0 + 32.0°  
**Efficiency** 95 %  
**Peak intensity** 1 cd/lm  
**LEDs/each optic** 1  
**Light colour** White  
**Required components:**

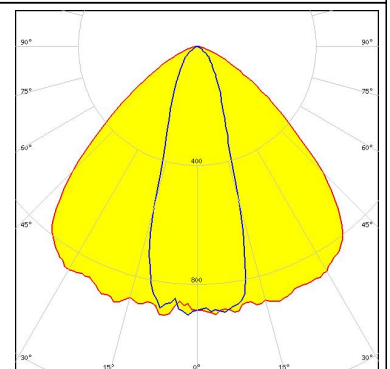



#### GENERAL INFORMATION:

NOTE: The typical beam angle will be changed by different color, chip size and chip position tolerance. The typical total beam angle is the full angle measured where the luminous intensity is half of the peak value.

#### MATERIALS:

As part of our continuous research and improvement processes, and to ensure the best possible quality and availability of our products, LEDiL reserves the right to change material grades without notice.

#### PRODUCT DATA USER AGREEMENT AND DISCLAIMER:

The measured data in the provided downloadable LEDiL Product Datasheets and Mechanical 2D-Drawings is rounded and provided as reference for planning. LEDiL Oy's optical specifications have been verified by conducting performance testing of the products in accordance with the company's quality system. The reported data are averaged results of multiple measurements with typical variation. LEDiL Oy reserves the right to without prior notification make changes and improvements to its products.

LEDiL Oy assumes neither warranty, nor guarantee nor any other liability of any kind for the contents and correctness of the provided data. The provided data has been generated with highest diligence but the provided data may in reality not represent the complete possible variation range of all intrinsic parameters. Therefore, in certain cases a deviation from the provided data could occur.

LEDiL Oy reserves the right to undertake technical changes of its products without further notification which could lead to changes in the provided data. LEDiL Oy assumes no liability of any kind for the possible deviation from any provided data or any other damage resulting from the usage of the provided data.

The user agrees to this disclaimer and user agreement with the download or usage of the provided files.

#### LEDiL Oy

Joensuunkatu 13  
FI-24240 SALO  
Finland

#### LEDiL Inc.

228 West Page Street  
Suite D  
Sycamore IL 60178  
USA

#### Local sales and technical support

[www.ledil.com/  
where\\_to\\_buy](http://www.ledil.com/where_to_buy)

#### Shipping locations

Salo, Finland  
Hong Kong, China

#### Distribution Partners

[www.ledil.com/  
where\\_to\\_buy](http://www.ledil.com/where_to_buy)

## Данный компонент на территории Российской Федерации

### Вы можете приобрести в компании MosChip.

Для оперативного оформления запроса Вам необходимо перейти по данной ссылке:

<http://moschip.ru/get-element>

Вы можете разместить у нас заказ для любого Вашего проекта, будь то серийное производство или разработка единичного прибора.

В нашем ассортименте представлены ведущие мировые производители активных и пассивных электронных компонентов.

Нашей специализацией является поставка электронной компонентной базы двойного назначения, продукции таких производителей как XILINX, Intel (ex.ALTERA), Vicor, Microchip, Texas Instruments, Analog Devices, Mini-Circuits, Amphenol, Glenair.

Сотрудничество с глобальными дистрибьюторами электронных компонентов, предоставляет возможность заказывать и получать с международных складов практически любой перечень компонентов в оптимальные для Вас сроки.

На всех этапах разработки и производства наши партнеры могут получить квалифицированную поддержку опытных инженеров.

Система менеджмента качества компании отвечает требованиям в соответствии с ГОСТ Р ИСО 9001, ГОСТ РВ 0015-002 и ЭС РД 009

### Офис по работе с юридическими лицами:

105318, г.Москва, ул.Щербаковская д.3, офис 1107, 1118, ДЦ «Щербаковский»

Телефон: +7 495 668-12-70 (многоканальный)

Факс: +7 495 668-12-70 (доб.304)

E-mail: [info@moschip.ru](mailto:info@moschip.ru)

Skype отдела продаж:

moschip.ru

moschip.ru\_4

moschip.ru\_6

moschip.ru\_9