



### FEATURES



Highest power rating with long life – Standard parts stocked\*

### APPLICATIONS

Wearable electronic & IoT devices – Memory backup circuits

|                             |  |  |
|-----------------------------|--|--|
| Nominal Voltage             | 3.7VDC (4.2VDC to 3.0VDC)  |  |
| Operating Temperature Range | -20°C to +60°C   |  |
| Storage Temperature Range   | -20°C to +60°C (one month)<br>-20°C to +40°C (up to 3 months)<br>-20°C to +25°C (up to 6 months) |  |
| Storage Capacity            | Nominal  | See part listing 0.2C rate, 3.0V cut-off |
|                             | Minimum  | See part listing 0.2C rate, 3.0V cut-off |
| Charging Voltage            | 4.2VDC $\pm$ 0.03V   |  |
| Charging current            | 0.5CA  |  |
| Charging Time               | < 3.0 hours  |  |
| Charging method             | Constant Current/ Constant Voltage (CCCV)  |  |
| Discharge Current           | Standard   | 0.2CA                                    |
|                             | Maximum  | 2CA                                      |
| Discharge Cut-off Voltage   | 3.0V   |  |
| Anode                       | Graphite   |  |
| Cathode                     | Lithium nickel manganese cobalt oxide  |  |
| Certification               | UL1642 – MH28281   |  |

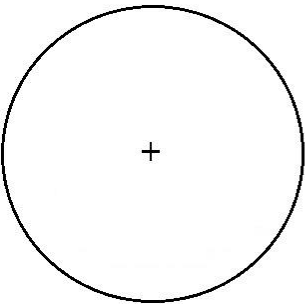
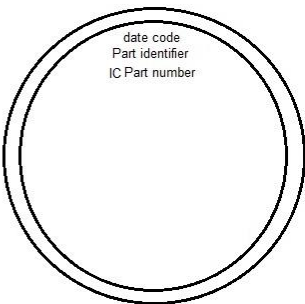
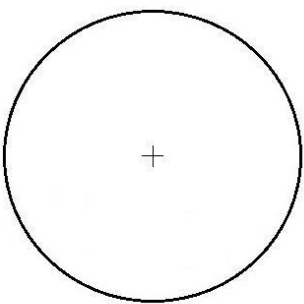
### Markings

| Standard (bare cells)   |   | Non-Standard Terminations  |   |
|---|---|--|---|
|  |  |  |  |
| Front   | Back  | Front  | Back  |



### Standard Coin Cell Options

| IC Part Number | Capacity (mAh) |      | Charging Current (mA) | Discharge Current (mA) |     | Maximum Internal Resistance (mΩ) | Approx. Weight (g) | Maximum Diameter (D mm) | Thickness (T mm) |
|----------------|----------------|------|-----------------------|------------------------|-----|----------------------------------|--------------------|-------------------------|------------------|
|                | Nom.           | Min. |                       | STD                    | MAX |                                  |                    |                         |                  |
|                |                |      |                       |                        |     |                                  |                    |                         |                  |
| RJD2048        | 120            | 110  | 55                    | 22                     | 220 | 700                              | 4.2                | 20.02                   | 5.0              |
| RJD2430C1      | 110            | 104  | 52                    | 21                     | 208 | 500                              | 4.5                | 24.5                    | 3.15             |
| RJD2440        | 150            | 140  | 70                    | 28                     | 280 | 800                              | 5.4                | 24.5                    | 4.3              |
| RJD2450        | 200            | 190  | 95                    | 38                     | 380 | 500                              | 6.5                | 24.5                    | 5.4              |
| RJD3032        | 200            | 190  | 95                    | 38                     | 380 | 600                              | 7.2                | 30                      | 3.4              |
| RJD3048        | 300            | 290  | 145                   | 58                     | 580 | 400                              | 9.3                | 30                      | 4.9              |
| RJD3555        | 500            | 490  | 245                   | 98                     | 980 | 200                              | 14.1               | 35.2                    | 5.7              |

### Standard PCM & Connector Options

| IC Part Number | Capacity (mAh) |      | Charging Current (mA) | Discharge Current (mA) |     | Maximum Internal Resistance (mΩ) | Approx. Weight (g) | Maximum Diameter (D mm) | Thickness (T mm) |
|----------------|----------------|------|-----------------------|------------------------|-----|----------------------------------|--------------------|-------------------------|------------------|
|                | Nom.           | Min. |                       | STD                    | MAX |                                  |                    |                         |                  |
|                |                |      |                       |                        |     |                                  |                    |                         |                  |
| RJD3048HPPV30M | 300            | 290  | 145                   | 58                     | 580 | 700                              | 9.3                | 30                      | 5.7              |
| RJD3555HPPV30M | 500            | 490  | 245                   | 98                     | 980 | 500                              | 14.1               | 35.2                    | 6.4              |

### Standard Leaded Options

| IC Part Number | Capacity (mAh) |      | Charging Current (mA) | Discharge Current (mA) |     | Maximum Internal Resistance (mΩ) | Approx. Weight (g) | Maximum Diameter (D mm) | Thickness (T mm) |
|----------------|----------------|------|-----------------------|------------------------|-----|----------------------------------|--------------------|-------------------------|------------------|
|                | Nom.           | Min. |                       | STD                    | MAX |                                  |                    |                         |                  |
|                |                |      |                       |                        |     |                                  |                    |                         |                  |
| RJD2048ST1     | 120            | 110  | 55                    | 22                     | 220 | 700                              | 4.2                | 20.02                   | 5.4              |
| RJD2430C1ST1   | 110            | 104  | 52                    | 21                     | 208 | 500                              | 4.5                | 24.5                    | 3.55             |
| RJD2440ST1     | 150            | 140  | 70                    | 28                     | 280 | 800                              | 5.4                | 24.5                    | 4.7              |
| RJD2450ST1     | 200            | 190  | 95                    | 38                     | 380 | 500                              | 6.5                | 24.5                    | 5.8              |
| RJD3032ST1     | 200            | 190  | 95                    | 38                     | 380 | 600                              | 7.2                | 30                      | 3.8              |
| RJD3048ST1     | 300            | 290  | 145                   | 58                     | 580 | 400                              | 9.3                | 30                      | 5.3              |
| RJD3555ST1     | 500            | 490  | 245                   | 98                     | 980 | 200                              | 14.1               | 35.2                    | 6.1              |



### Cell Dimensions

| IC Part Number | Fresh Cell              |                          |                         |                          | Cycled cell (after 500 cycles) |                          |
|----------------|-------------------------|--------------------------|-------------------------|--------------------------|--------------------------------|--------------------------|
|                | Shipping (Charged)      |                          | Full Charge             |                          | Full Charge                    |                          |
|                | Maximum Diameter (D mm) | Maximum Thickness (T mm) | Maximum Diameter (D mm) | Maximum Thickness (T mm) | Maximum Diameter (D mm)        | Maximum Thickness (T mm) |
| RJD2032C1*     | 20.02                   | 3.5                      | 20                      | 3.6                      | 20                             | 3.7                      |
| RJD2048*       | 20.02                   | 5                        | 20                      | 5.2                      | 20                             | 5.3                      |
| RJD2430C1*     | 24.5                    | 3.15                     | 24.5                    | 3.25                     | 24.5                           | 3.3                      |
| RJD2440*       | 24.5                    | 4.3                      | 24.5                    | 4.4                      | 24.5                           | 4.5                      |
| RJD2450*       | 24.5                    | 5.4                      | 24.5                    | 5.5                      | 24.5                           | 5.6                      |
| RJD3032*       | 30                      | 3.4                      | 30                      | 3.5                      | 30                             | 3.6                      |
| RJD3048*       | 30                      | 4.9                      | 30                      | 4.9                      | 30                             | 5.2                      |
| RJD3555*       | 35.2                    | 5.7                      | 35.2                    | 5.8                      | 35.2                           | 6.3                      |

### Part Numbering

RJD 2032C1    A    B    C    D    E  
 Section 1    Section 2    Section 3    Section 4    Section 5    Section 6

**Section 1** – IC standard part number (Bare cell)

**Section 2** –Termination style

### Termination Styles

Contact IC for detailed drawings

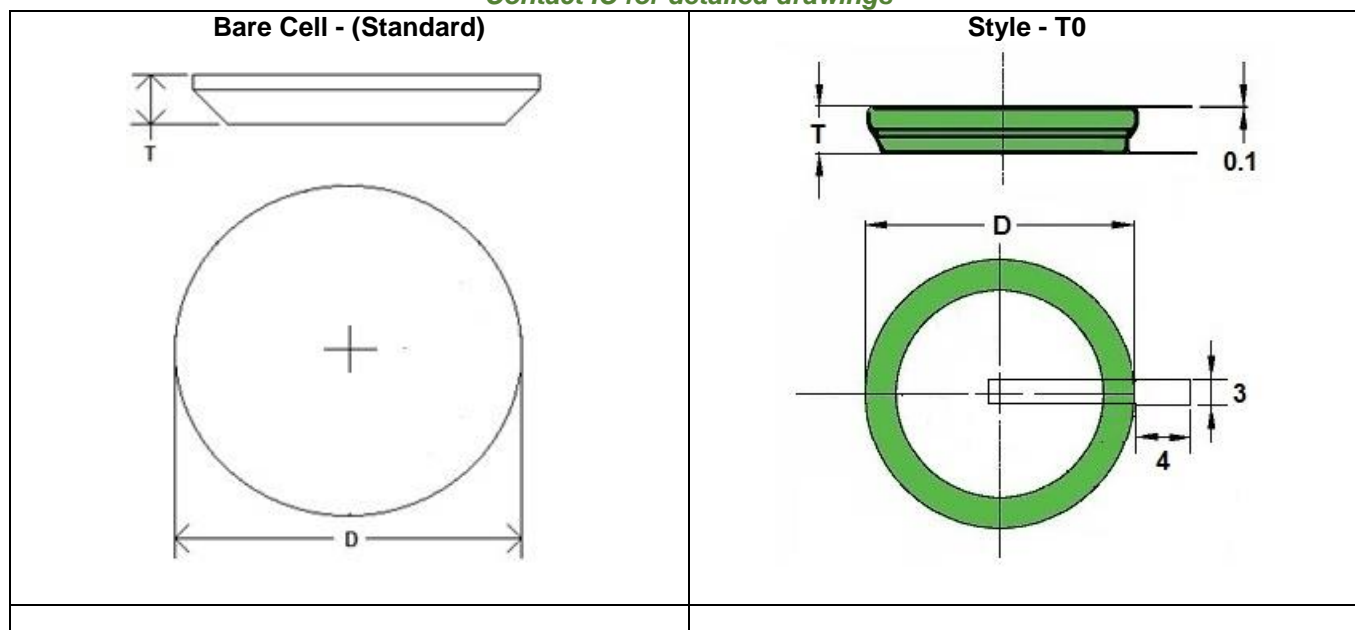

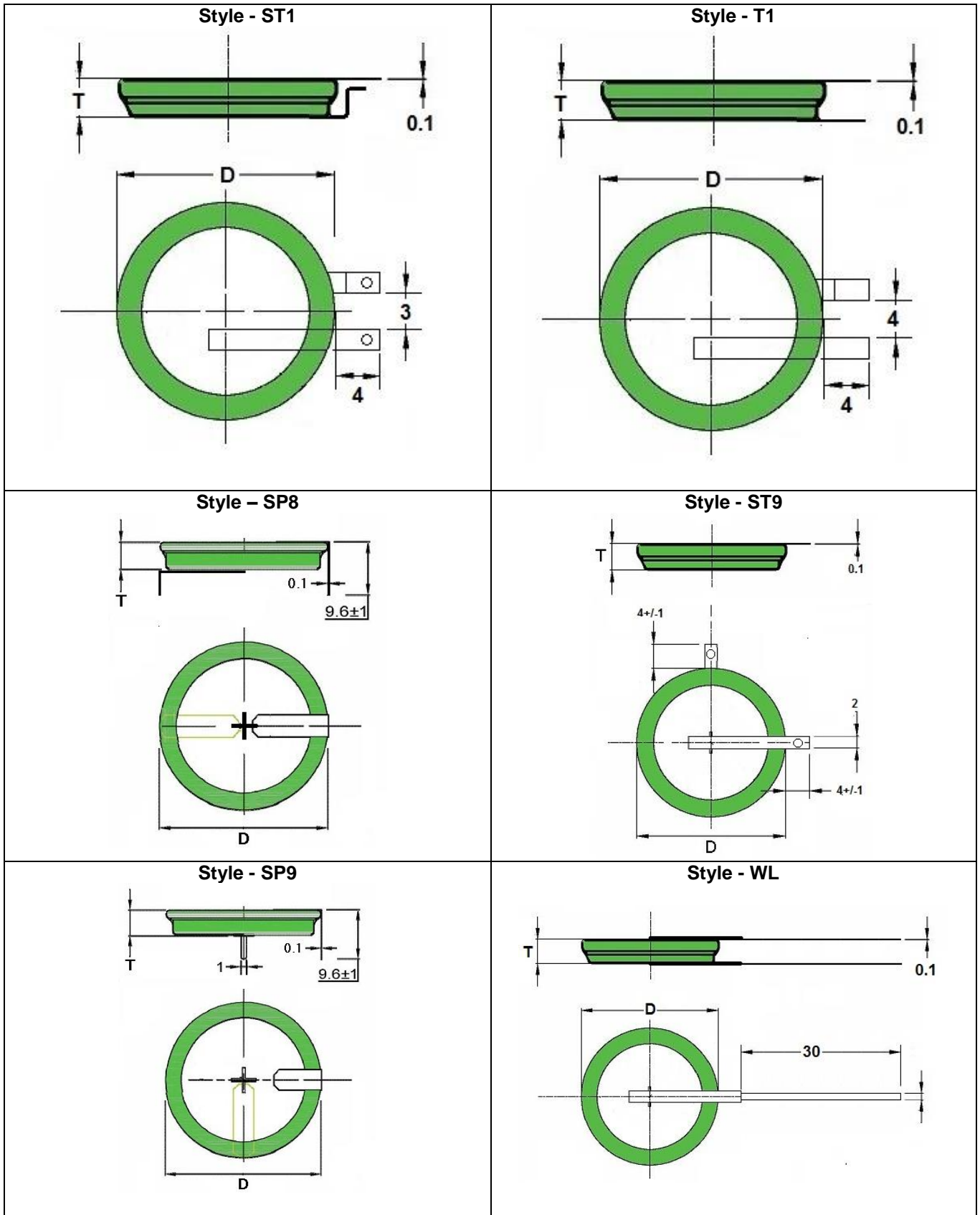

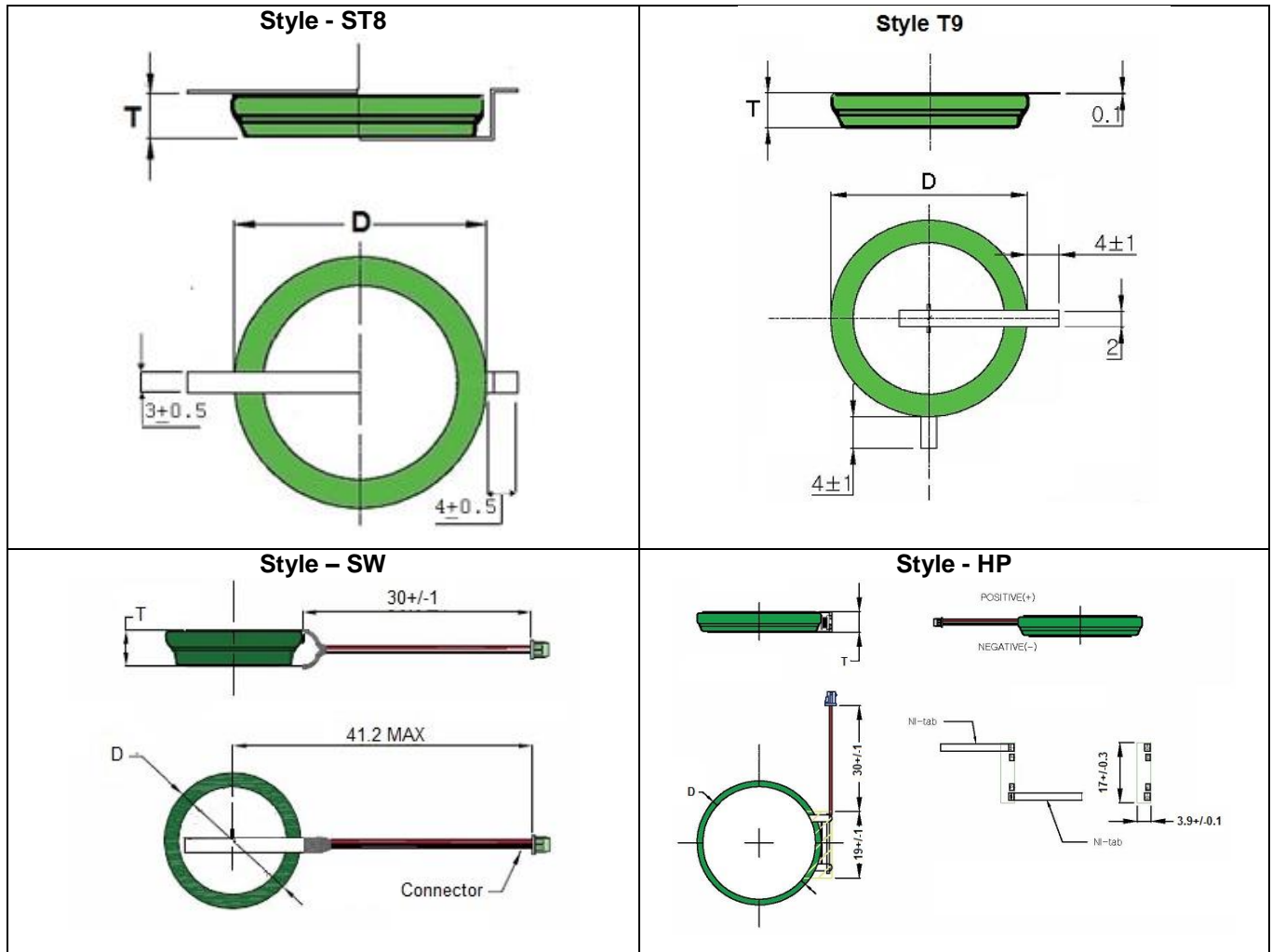

Contact IC if other termination type is preferred

**Section 3** – Connector supplied with PCM indicator, with connector is standard (Code P)

| Connector with PCM | Connector without PCM |
|--------------------|-----------------------|
| P                  | N                     |

**Section 4** - Wire gauge for types SW and HP, 30 gauge is standard (Code V).

\*Contact IC if a different wire gauge is needed.

**Section 5** – Lead Length for types SW and HP, 30mm. is the standard. (Code 30)

\*Contact IC if a different wire length is needed.

**Section 6** – Connector option for types SW and HP, Molex is standard (Code M)





### Connector types

| IC Code                          | M (Standard)  | J   |
|----------------------------------|---|---|
| Connector Manufacturer           | Molex   | JST   |
| Connector Part Number            | 51021-0200  | ACHR-02V-S  |
| Drawing                          |   |   |
| Detailed specifications location | <a href="http://www.molex.com/pdm_docs/sd/51021_0200_sd.pdf">http://www.molex.com/pdm_docs/sd/51021_0200_sd.pdf</a> | <a href="http://www.jst.com/home23.html">http://www.jst.com/home23.html</a> |

HP lead style are supplied with a PCM (Protection Circuit Module).  
 PCM Type: Powerlogics part # RJD 201 or RJD 9901 (see Protection Circuit Module section below for complete specifications).

#### PCM option

### Protection Circuit Module

(Only for HP lead style)

| Specification   | RJD 9901                      | RJD 201   |
|---|-------------------------------|---|
| PCM used with indicated corresponding bare cell part number | RJD3032<br>RJD3048<br>RJD3555 | RJD2032C1, RJD2048,<br>RJD2430C1, RJD2440,<br>RJD2450 |
| Main IC   | SP31ABE                       | MP29A   |
| PCB   | SALTEK, APEX                  | SALTEK, APEX  |
| FET   | X                             | X   |
| PTC   | MicroSMD175F-2 (TE)           | X   |
| L terminal  | X                             | X   |
| Capacitor   | 2Point                        | 2Point  |
| Resistor  | 2Point                        | 1Point  |
| Dimension(L*W*T)  | 16.9*3.9*2.0mm                | 11.0X3.5X1.75mm                                       |
| Wake-up Function  | NO                            | NO  |
| Overcharge Detection Voltage                                | 4.275V ± 25mV                 | 4.25V~4.3V  |
| Overcharge Detection Delay Time                             | 700.0mSec ~ 1300mSec          | 800.0mSec ~ 1200mSec                                  |
| Over-Discharge Detection Voltage                            | 2.242V~2.358V                 | 2.76V~2.84V   |
| Over-Discharge Detection Delay Time                         | 14.0mSec~26.0mSec             | 16.0mSec~24.0mSec                                     |



|  |                      |                      |
|--|----------------------|----------------------|
| Over-Discharge Current Detection             | 1.2 ~ 4.0A           | 0.77 ~ 1.76A         |
| Overcharge Current Detection                 | 0.9A ~ 4.4A          | 0.9A ~ 4.4A          |
| Over-Discharge Current Protection Delay Time | 8.0mSec ~ 16.0mSec   | 4.8mSec ~ 7.2mSec    |
| Short Detection Delay Time                   | 100μs ~ 500μs        | 280μs ~ 560μs        |
| PCM Impedance                                | < 220mΩ              | < 46mΩ               |
| Operation Current Consumption                | Max 6.0μA(TYP 4.0μA) | Max 6.0μA(TYP 3.0μA) |
| Power-Down Mode Current Consumption          | Max 0.1μA            | Max 0.1μA            |
| Distance Between B+, B- Tab                  | 13.93mm              | 5.25mm               |

### Battery Operation Instruction:

#### Charging

- Charge the battery in a temperature range of 0°C to + 45°C.
- Charge the battery at a constant current of 0.5C until 4.20VDC±0.03VDC per cell is attained. Charge rates greater than 1C are NOT recommended. (C: Rated Capacity of Battery)
- Maintain charge voltage at 4.20VDC per cell for 3.0 hours (recommended for maximum capacity).  
*\* Use a constant current, constant voltage (CC/CV) lithium-ion (Li+) battery charge controller.*  
*\* Do not continue to charge battery over specified time.*

#### Discharging

- Recommended cut-off voltage to 3.0VDC. Recommended maximum discharge rate is 2C at constant current.
- For maximum performance, discharge the battery in a temperature range of -20°C to + 45°C.

#### Protection Circuit

Protection circuit can be provided upon request. However, protection circuit may be omitted for most applications without damaging performance and safety. Please consult our engineering staff for technical advice.

#### Storage Recommendations

##### Storage Temperature and Humidity

Store the battery within a temperature range of -20°C to +45°C, low humidity, non-corrosive gas atmosphere and no condensation on the battery.

##### Long Period Storage

In case of a long storage period (more than 3 months), store the battery within a temperature range of -20°C to +25°C, low humidity and non-corrosive gas atmosphere. Extended storage periods will reduce the capacity of the battery.

##### Standard Test Conditions

Unless otherwise specified, all tests are conducted at 25°C ± 3°C and relative humidity of 65% ± 20%.



### Electrical Characteristics

#### Standard Charge and Discharge Conditions

- A. The "Standard Charge" means charging the Cell with initial charge current (0.5C) and with a constant voltage of 4.2VDC (+ 0.03VDC) and the specified cut-off current (see table 1) at 25°C for 3 hours.
- B. Standard discharge means discharging cell with constant discharge current (0.2C)(see table 1) and with 3.0VDC cut-off voltage at 25°C
- C. Initial Discharge Capacity
- D. The initial capacity measured under the standard test conditions
- E. Initial Discharge Capacity: See standard part listing
- F. Initial Internal resistance: see standard part listing
- G. Internal resistance measured at 1 kHz after Standard Charge.
- H. Cycle life (500 cycles with constant charge listed in note A above and constant discharge rate of 0.5C)
- I. Temperature dependence of discharge capacity. See discharge table below.
- J. Relative capacity at each temperature measured with a constant discharge current (0.2C) with 3.0VDC cutoff after the standard charge shown below.

| IC Part Number | Discharge Temperature |       |       |      |
|----------------|-----------------------|-------|-------|------|
|                | -20°C                 | -10°C | 25°C  | 60°C |
| RJD2032C1      | >60 %                 | >80%  | 100 % | >95% |
| RJD2048        | >60 %                 | >80%  | 100 % | >80% |
| RJD2430C1      | >60 %                 | >80%  | 100 % | >95% |
| RJD2440        | >60 %                 | >80%  | 100 % | >80% |
| RJD2450        | >60 %                 | >80%  | 100 % | >80% |
| RJD3032        | >60 %                 | >80%  | 100 % | >80% |
| RJD3048        | >60 %                 | >80%  | 100 % | >80% |
| RJD3555        | >60 %                 | >80%  | 100 % | >80% |

**Table 1**

| IC Part Number | Charging Current (0.5C) (mA) | Constant Discharge Current (0.2C) (mA) | Charging end condition (at CV mode) (mA) | Capacity after 500 cycles (mAh) |
|----------------|------------------------------|--|--|---------------------------------|
| RJD2032C1      | 40                           | 16                                     | 2.4                                      | 56                              |
| RJD2048        | 60                           | 24                                     | 3.6                                      | 77                              |
| RJD2430C1      | 55                           | 22                                     | 3.3                                      | 72.8                            |
| RJD2440        | 75                           | 30                                     | 4.5                                      | 98                              |
| RJD2450        | 100                          | 40                                     | 6  | 133                             |
| RJD3032        | 100                          | 40                                     | 6  | 133                             |
| RJD3048        | 150                          | 60                                     | 9  | 203                             |
| RJD3555        | 250                          | 100                                    | 15                                       | 350                             |





### Discharge Characteristics on Current Load (C-Rate)

Relative capacity at each load, measured with constant discharge current 0.2C, 0.5C, 1.0C, 2C with 3.0VDC cut-off after Standard Charge shown below.

| Charge Current  | Discharge Current |        |        |        |
|-----------------|-------------------|--------|--------|--------|
| Standard Charge | 0.2 CA            | 0.5 CA | 1 CA   | 2.0 CA |
|                 | 100 %             | > 95 % | > 90 % | > 50%  |

### Shipment

The Cell shall be shipped with 30% of the nominal voltage. (Nominal Cell voltage range: 3.7 ~ 3.8 V). 30% SOC is only for air transport.

### Storage Characteristics

After storage at the conditions listed below, the battery is measured at the standard charge and discharge conditions stated under the electrical characteristics.

| Storage Condition      | Charge State    | Capacity Retention | Capacity Recovery |
|------------------------|-----------------|--------------------|-------------------|
| 20 days at 60°C        | Shipping charge | -                  | > 85%             |
| 20 days at 60°C        | Full charge     | > 70%              | > 85%             |
| 60 days at 60°C        | Full charge     | > 40%              | > 60%             |
| 30 days at 60°C, 90%RH | Full charge     | > 40%              | > 70%             |

### Safety Test

| Test                               | Test Method  | Criteria              |
|------------------------------------|--|-----------------------|
| High Temperature                   | Storing a cell at 90°C for 4 hours after being charged to 4.2VDC   | No leakage            |
| High Temperature and High Humidity | Storing a cell at 60°C and 90% RH for 1 week after being charged to 4.2VDC   | No leakage            |
| Thermal Shock Test                 | Store a fully charged cell (4.2VDC) at 60°C for 2 hours then at -20°C for 2 hours. 10 cycles with a maximum transition time of 5 minutes.  | No leakage            |
| Hot Box Test                       | A cell is to be heated in a gravity convection oven. The temperature of the oven is to be raised 5°C+/- 2°C per minute to a temperature of 130°C and remain at that temperature for 10 minutes | No explosion, No fire |
| Overcharge Test                    | Charge the test samples with constant current (3C) and voltage 4.5VDC. Test samples remain on test for 2.5 hours   | No explosion, No fire |
| Impact Test                        | A test cell is to be placed on a flat surface. The bar of 9.1 kg weight and 15.8 mm diameter is dropped from a height of 610 mm onto the cell.   | No explosion, No fire |



|                    |  |  |
|--------------------|--|--|
| Short-Circuit Test | A cell is to be short-circuited by connecting the positive and negative terminals of the battery with copper wire having a maximum resistance load of 100mΩ. | No fire or explosion, until battery is completely discharged |
| Nail Test          | A stainless steel nail having a diameter of 4.0 mm is punched through the cell until the nail has passed through the opposite side of the cell.              | No explosion, No fire  |
| Applying Pressure  | Placing pressure on entire surface of a fully charged cell with 7kg for 72 hours   | No leakage, No weight decrease                               |

### Precautions and Safety Instructions

Lithium-Ion rechargeable batteries subjected to abusive conditions can become damaged and/or cause personal injury. Please read and observe the standard battery precautions below before using.

**Note 1.** The customer is required to contact Illinois Capacitor in advance, if and when the customer needs other applications or operating conditions other than those described in this document.

**Note 2.** Illinois Capacitor will take no responsibility for any accident where the cell is used under other conditions than those described in this document.

### Precautions and Safety Instructions:

- a. Do not expose the battery to extreme heat or flame.
- b. Do not short circuit, over-charge or over-discharge the battery.
- c. Do not subject the battery to strong mechanical shocks.
- d. Do not immerse the battery in water or sea water, or get it wet.
- e. Do not reverse the polarity of the battery for any reason.
- f. Do not disassemble or modify the battery.
- g. Do not remove charge/discharge protection circuitry.
- h. Do not handle or store with metallic objects like necklaces, coins or hairpins, etc.
- i. Do not use the battery if possible damage or deformation is present.
- j. Do not connect battery to the plug socket or car-cigarette-plug.
- k. Do not directly solder onto the battery. Only spot weld lead onto battery. Soldering iron temperature should be limited to 350°C with a soldering time of <5 seconds.
- l. Do not place batteries in a solder bath.
- m. Do not touch a leaked battery directly.
- n. Do not use for other equipment.
- o. Do not mix Lithium-ion batteries.
- p. Do not use or leave the battery in direct sunlight (or in heated car by sunshine).
- q. Keep battery away from children.
- r. Use only the specified charger and observe charging requirement.
- s. Do not drive a nail into battery or strike battery with another battery or insert a screw into the battery
- t. Do not smash or throw battery.
- u. Recharge the battery every 6 months.
- v. Follow recommended charging conditions when charging battery.



### Warnings:

- a. Do not swallow. Keep out of reach of infants and children. If swallowed call physician immediately.
- b. Do not put battery in microwave or pressure cooker.
- c. Do not use battery together with a primary battery, such as dry battery types or batteries with different capacities.
- d. Do not replace battery with a different type or model.
- e. Discontinue use of battery if an unusual odor, discoloration, deformation, internal heating or other unusual characteristic changes are detected.
- f. Do not have any leaked electrolyte come in contact with eyes. If contact occurs flush eyes immediately with water and consult a doctor.
- g. If charging does not stop after expected charging time, stop charging battery.

### Requirement for Safety Assurance

For safety assurance, please discuss the equipment design, its system and protection circuit of Lithium-ion battery with Illinois capacitor in advance.

Consult with Illinois Capacitor about high rate current, rapid charge and special application.

## Данный компонент на территории Российской Федерации

### Вы можете приобрести в компании MosChip.

Для оперативного оформления запроса Вам необходимо перейти по данной ссылке:

<http://moschip.ru/get-element>

Вы можете разместить у нас заказ для любого Вашего проекта, будь то серийное производство или разработка единичного прибора.

В нашем ассортименте представлены ведущие мировые производители активных и пассивных электронных компонентов.

Нашей специализацией является поставка электронной компонентной базы двойного назначения, продукции таких производителей как XILINX, Intel (ex.ALTERA), Vicor, Microchip, Texas Instruments, Analog Devices, Mini-Circuits, Amphenol, Glenair.

Сотрудничество с глобальными дистрибьюторами электронных компонентов, предоставляет возможность заказывать и получать с международных складов практически любой перечень компонентов в оптимальные для Вас сроки.

На всех этапах разработки и производства наши партнеры могут получить квалифицированную поддержку опытных инженеров.

Система менеджмента качества компании отвечает требованиям в соответствии с ГОСТ Р ИСО 9001, ГОСТ РВ 0015-002 и ЭС РД 009

### Офис по работе с юридическими лицами:

105318, г.Москва, ул.Щербаковская д.3, офис 1107, 1118, ДЦ «Щербаковский»

Телефон: +7 495 668-12-70 (многоканальный)

Факс: +7 495 668-12-70 (доб.304)

E-mail: [info@moschip.ru](mailto:info@moschip.ru)

Skype отдела продаж:

moschip.ru

moschip.ru\_4

moschip.ru\_6

moschip.ru\_9