

LOC		DIST		REVISIONS			
P	LTR	DESCRIPTION	DATE	DMN	APVD		
Z1		REVISED PER ECO-08-026581	30OCT08	HMR	MM		
Z2		REVISED PER ECO-09-021510	12SEP09	KK	AEG		

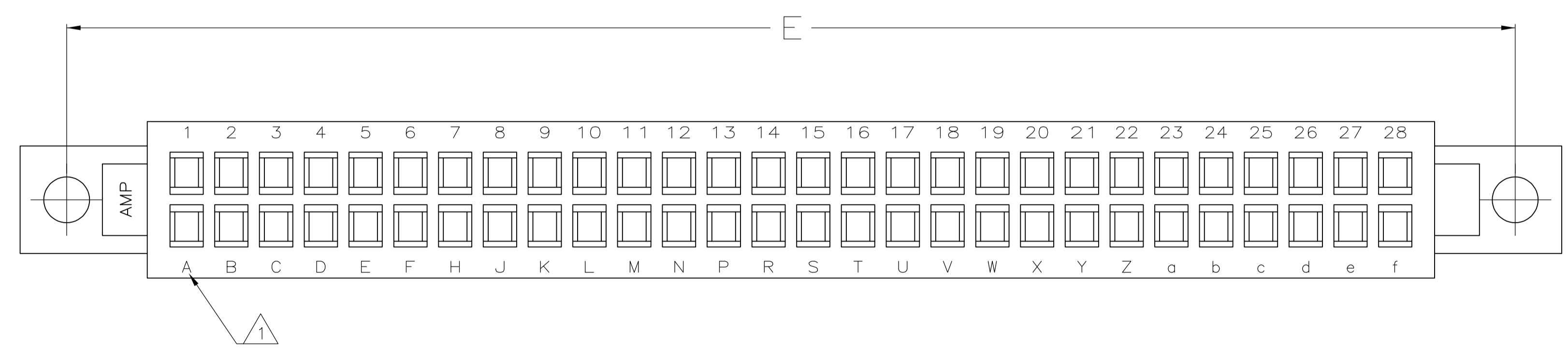

THIS DRAWING IS A CONTROLLED DOCUMENT.		DIN J GALLUCCI BG 12-9-92		Tyco Electronics Corporation	
DIMENSIONS: mm [INCHES]		TOLERANCES UNLESS OTHERWISE SPECIFIED:		Tyco Electronics Corporation Harrisburg, PA 17105-3608	
0 PLC ± -		1 PLC ± -		APVD H ROSE 3/2/94	
1 PLC ± -		2 PLC ± -		NAME H ROSE	
2 PLC ± -		3 PLC ± 0.13 [.005]		PRODUCT SPEC	
3 PLC ± -		4 PLC ± -		APPLICATION SPEC	
4 PLC ± -		ANGLES ± -		SIZE A1	
MATERIAL GLASS FILLED POLYESTER COLOR: BLACK		FINISH -		CAGE CODE DRAWING NO. 00779	
				RESTRICTED TO	
				WEIGHT -	
				SCALE 1:1	
				SHEET 1 OF 3	
				REV Z2	
				CUSTOMER DRAWING	
				DRAWING NO. 583864	

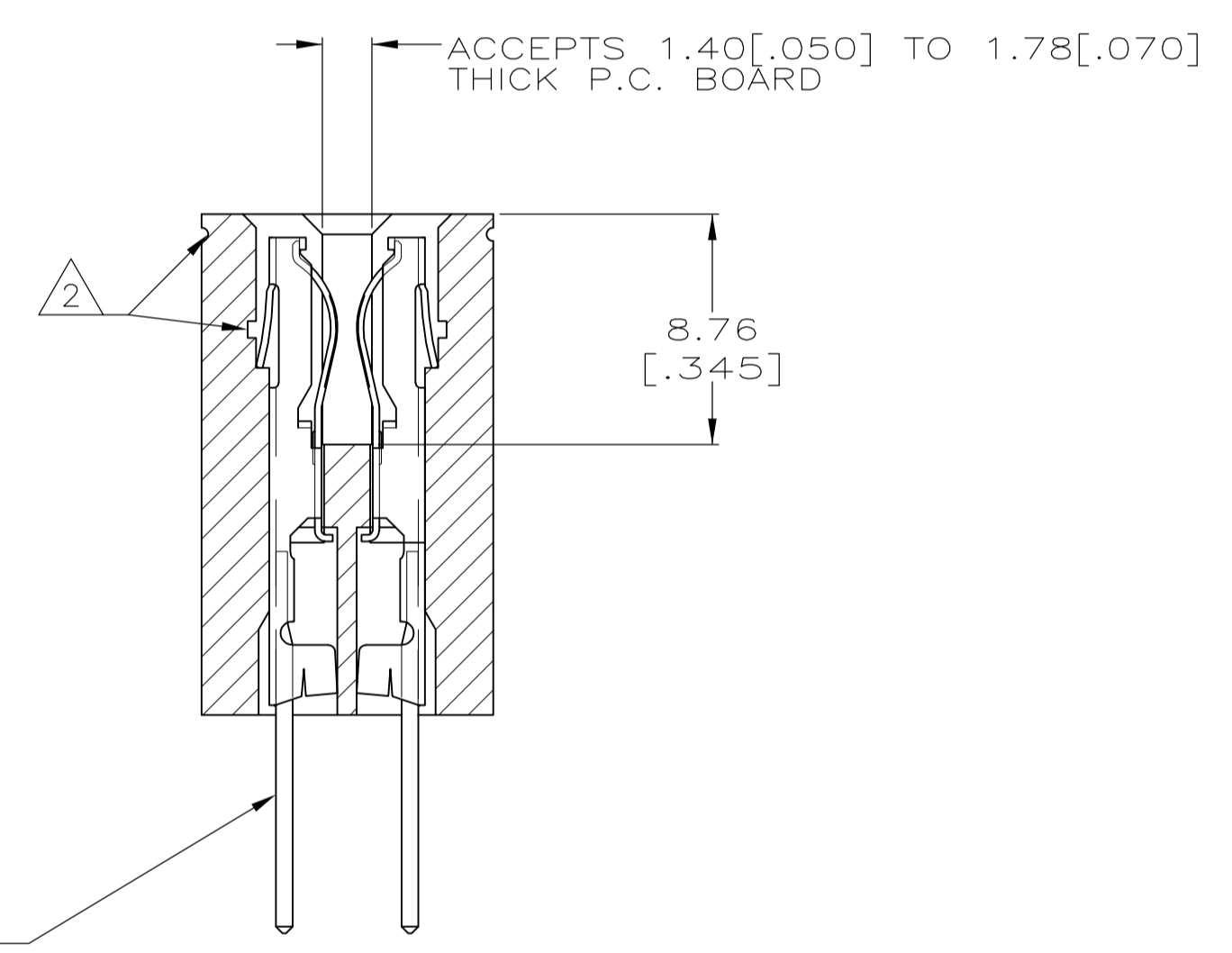
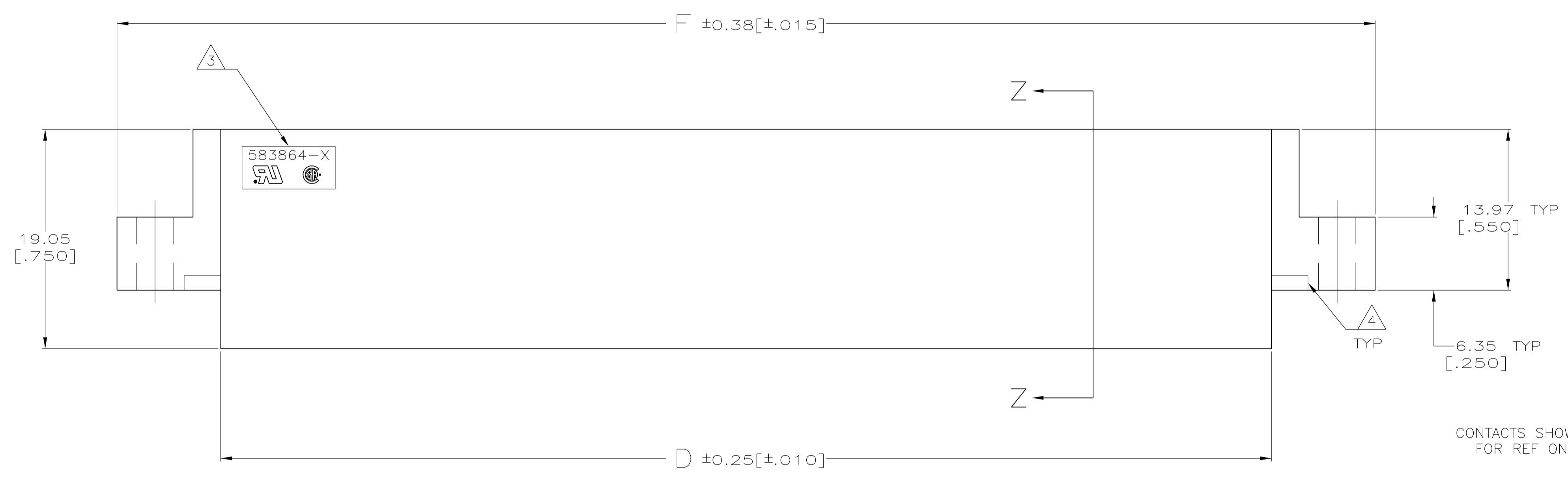
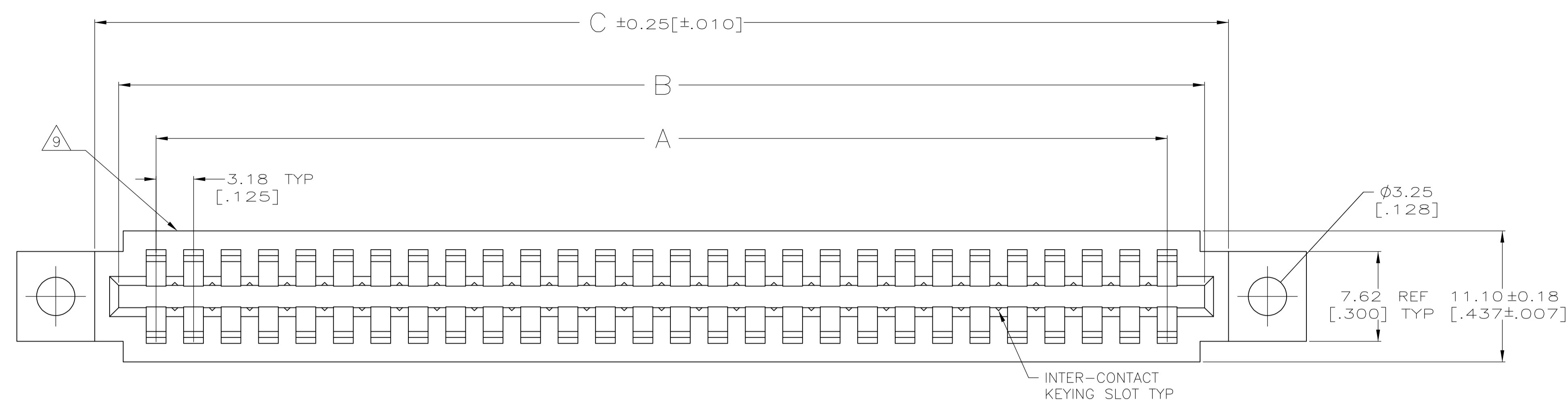
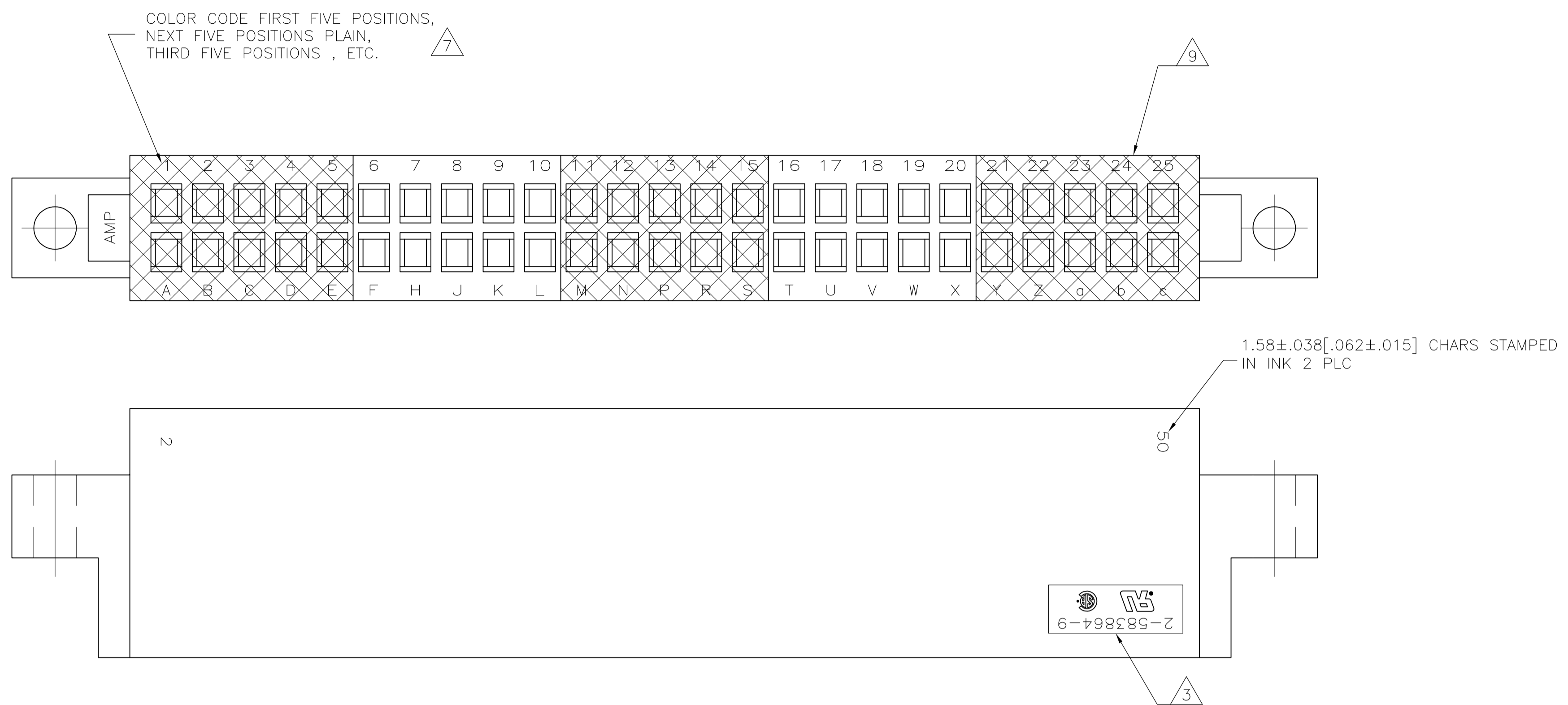

- 1 FIRST 22 POSITIONS MARKED WITH UPPER CASE LETTERS, FOLLOWED BY LOWER CASE LETTERS, FOLLOWED BY UPPERCASE AA, AB, AC ETC. CHARACTERS G, I, O AND Q ARE OMITTED. SEE TABLE FOR END CAVITY IDENTIFICATION.
- 2 PULL GROOVES OPTIONAL THESE LOCATIONS REF ONLY.
- 3 HOUSING PART NUMBER, UL & CSA LOGO'S TO BE MOLDED IN THIS AREA. UL LOGO PER 1-18838-3, CSA LOGO PER 1-18839-3.
- 4 CORING AT AMP'S OPTION REF ONLY.
- 5 SPECIAL STAMPING FOR 2-583864-7.
- 6 SPECIAL STAMPING FOR 2-583864-8.
- 7 SPECIAL STAMPING FOR 2-583864-9.
- 8 SPECIAL STAMPING FOR 3-583864-1.
- 9 DATE CODE TO BE MOLDED IN THIS AREA
- 10 OBSOLETE PARTS: OBSOLETE CIS STREAMLINING PER D.RENAUD/D.SINISI

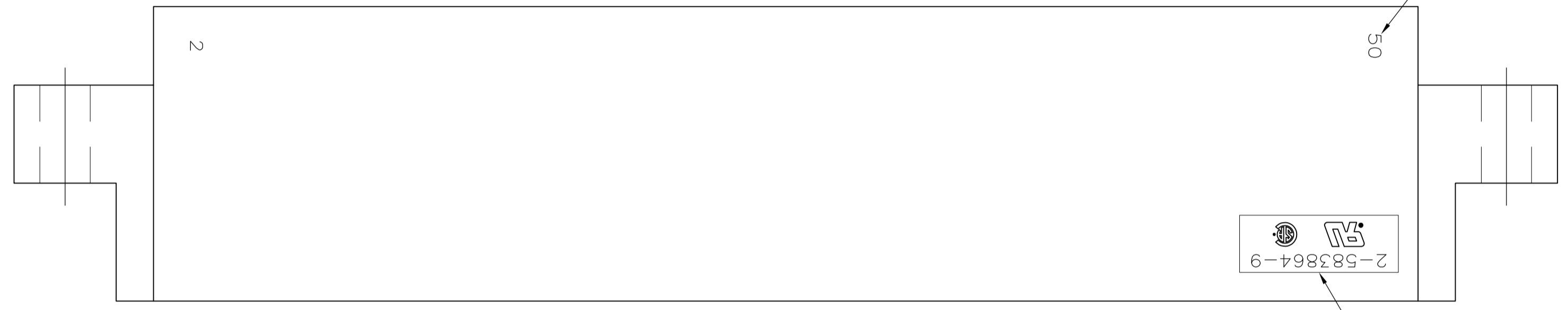

2-583864-9

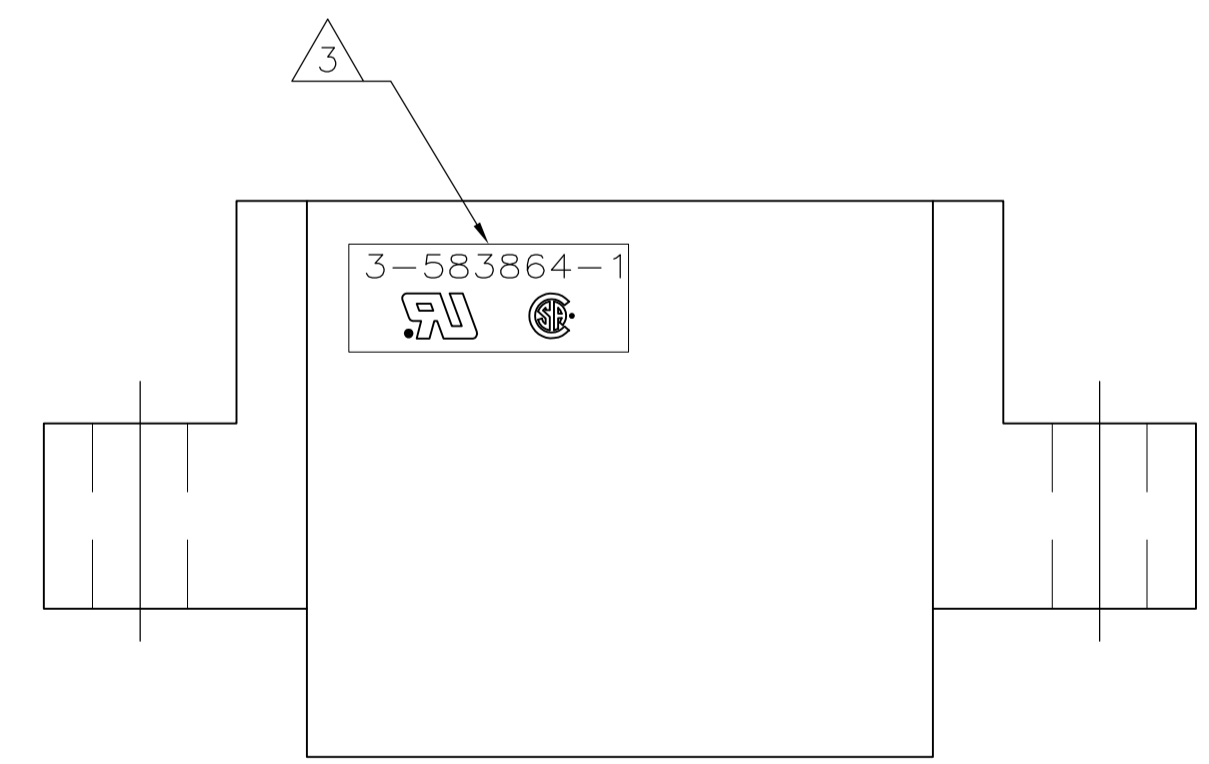

3-583864-1

OBSOLETE		39.50	32.89	21.46	26.29	22.23	15.88	6	3-583864-1
		[1.555]	[1.295]	[.845]	[1.035]	[.875]	[.625]		
OBSOLETE		99.82	93.22	81.79	86.61	82.55	76.20	25	2-583864-9
		[3.930]	[3.670]	[3.220]	[3.410]	[3.250]	[3.000]		
OBSOLETE		118.87	112.27	100.84	105.66	101.60	95.25	31	2-583864-8
		[4.680]	[4.420]	[3.970]	[4.160]	[4.000]	[3.750]		
OBSOLETE		147.45	140.84	129.41	134.24	130.18	123.83	40	2-583864-7
		[5.805]	[5.545]	[5.095]	[5.285]	[5.125]	[4.875]		
OBSOLETE		118.87	112.27	100.84	105.66	98.12	95.25	31	2-583864-5
		[4.680]	[4.420]	[3.970]	[4.160]	[3.863]	[3.750]		
OBSOLETE		134.75	128.14	116.71	121.56	117.48	111.13	36	2-583864-3
		[5.305]	[5.045]	[4.595]	[4.785]	[4.625]	[4.375]		
		115.70	109.09	97.66	102.49	98.43	92.08	30	2-583864-1
		[4.555]	[4.295]	[3.845]	[4.035]	[3.875]	[3.625]		
OBSOLETE		160.15	153.54	142.11	146.94	142.88	136.53	44	1-583864-9
		[6.305]	[6.045]	[5.595]	[5.785]	[5.625]	[5.375]		
		147.45	140.84	129.41	134.24	130.18	123.83	40	1-583864-7
		[5.805]	[5.545]	[5.095]	[5.285]	[5.125]	[4.875]		
OBSOLETE		118.87	112.27	100.84	105.66	101.60	95.25	31	1-583864-5
		[4.680]	[4.420]	[3.970]	[4.160]	[4.000]	[3.750]		
		109.35	102.74	91.31	96.14	92.08	85.73	28	1-583864-3
		[4.305]	[4.045]	[3.595]	[3.785]	[3.625]	[3.375]		
OBSOLETE		99.82	93.22	81.79	86.61	82.55	76.20	25	1-583864-1
		[3.930]	[3.670]	[3.220]	[3.410]	[3.250]	[3.000]		
OBSOLETE		90.30	83.69	72.26	77.09	73.03	66.68	22	-583864-9
		[3.555]	[3.295]	[2.845]	[3.035]	[2.875]	[2.625]		
OBSOLETE		77.60	70.99	59.56	64.39	60.33	53.98	18	583864-7
		[3.055]	[2.795]	[2.345]	[2.535]	[2.375]	[2.125]		
OBSOLETE		68.07	61.47	50.04	54.86	50.80	44.45	15	583864-5
		[2.680]	[2.420]	[1.970]	[2.160]	[2.000]	[1.750]		
OBSOLETE		52.20	45.59	34.16	38.99	34.93	28.58	10	-583864-3
		[2.055]	[1.795]	[1.345]	[1.535]	[1.375]	[1.125]		
OBSOLETE		39.50	32.89	21.46	26.29	22.23	15.88	6	-583864-1
		[1.555]	[1.295]	[.845]	[1.035]	[.875]	[.625]		
		F	E	D	C	B	A	POSN	PART NUMBER

THIS DRAWING IS A CONTROLLED DOCUMENT. **Tyco Electronics** Tyco Electronics Corporation Harrisburg, PA 17105-3608

12-9-92  
 J. GALLUCCI BO  
 3/2/94

APVD: H. ROSE  
 H. ROSE  
 3/2/94

NAME: HOUSING, CRIMP SNAP TWIN LEAF, .125 C/L WITH MOUNTING EARS

PRODUCT SPEC: -  
 APPLICATION SPEC: -  
 SIZE: A1  
 CAGE CODE: 00779  
 DRAWING NO: 583864

MATERIAL: - FINISH: - WEIGHT: -  
 CUSTOMER DRAWING SCALE: 4:1 SHEET 2 OF 3 REV: 22

LOC		DIST		REVISIONS			
P	LTR	DESCRIPTION	DATE	DNW	APVD		
-	-	SEE SHEET 1	-	-	-		

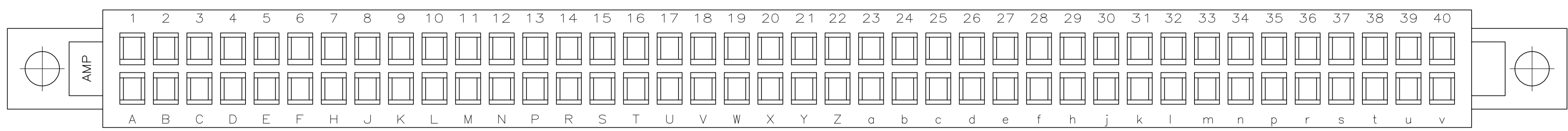

1.17[.046] HIGH CHARS INK, ONE SIDE TO BE ODD NUMBERS 1,3,5... 77,79 OTHER SIDE TO BE EVEN NUMBERS 2,4,6... 78,80

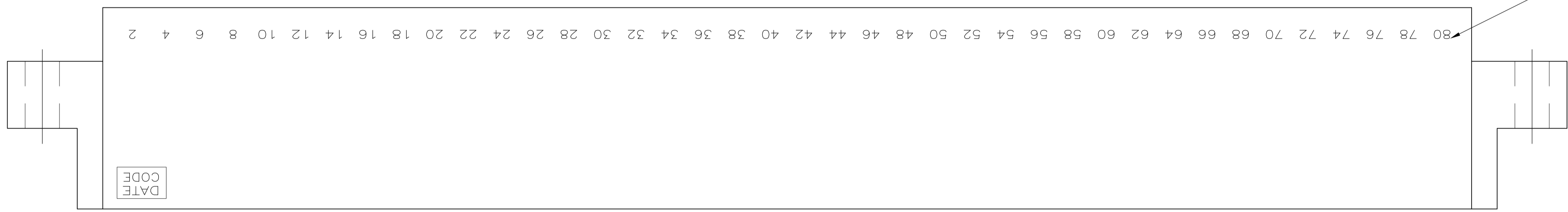

2-583864-7

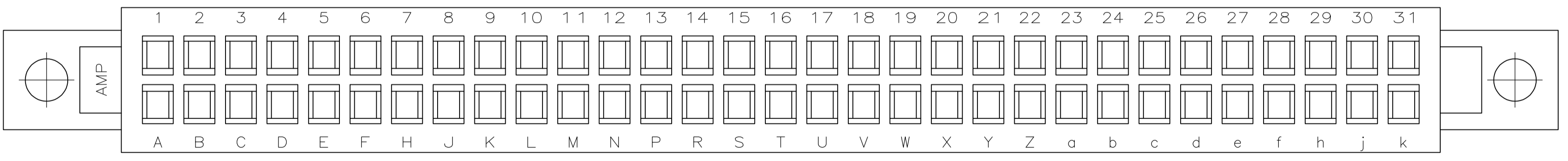

1.17[.046] HIGH CHARS INK, ONE SIDE TO BE ODD NUMBERS 1,3,5... 59,61 OTHER SIDE TO BE EVEN NUMBERS 2,4,6... 60,62

2-583864-8

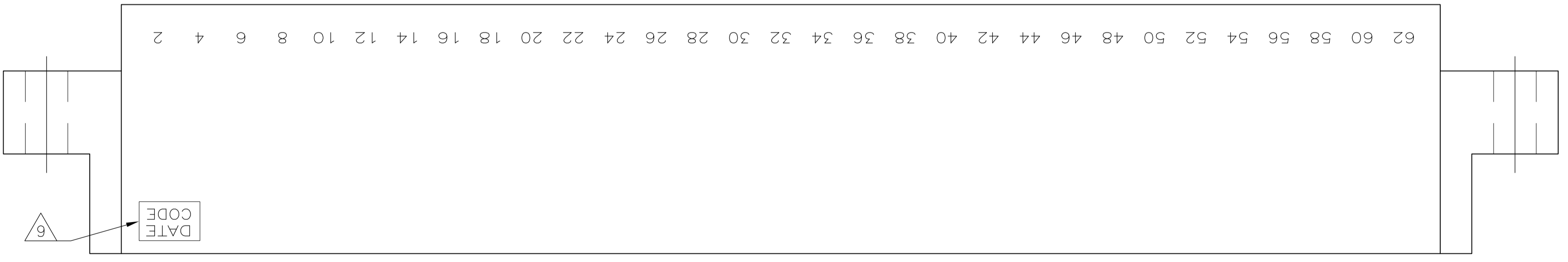

THIS DRAWING IS A CONTROLLED DOCUMENT.		DIN 12-9-92		Tyco Electronics Corporation	
DIMENSIONS: mm [INCHES]		CHK H ROSE 3/2/94		Tyco Electronics Harrisburg, PA 17105-3608	
TOLERANCES UNLESS OTHERWISE SPECIFIED:		APVD H ROSE 3/2/94		NAME	
0. PLC ± -	1. PLC ± -	APPLICATION SPEC		HOUSING, CRIMP SNAP	
2. PLC ± -	3. PLC ± 0.13(.005)	WEIGHT		TWIN LEAF, .125 C/L	
4. PLC ± -	ANGLES ± -	CUSTOMER DRAWING		WITH MOUNTING EARS	
MATERIAL FINISH		SIZE		RESTRICTED TO	
		A1 00779		-	
		SCALE 1:1		SHEET 3 OF 3	
		DRAWING NO. C=583864		REV 22	

## Данный компонент на территории Российской Федерации

### Вы можете приобрести в компании MosChip.

Для оперативного оформления запроса Вам необходимо перейти по данной ссылке:

<http://moschip.ru/get-element>

Вы можете разместить у нас заказ для любого Вашего проекта, будь то серийное производство или разработка единичного прибора.

В нашем ассортименте представлены ведущие мировые производители активных и пассивных электронных компонентов.

Нашей специализацией является поставка электронной компонентной базы двойного назначения, продукции таких производителей как XILINX, Intel (ex.ALTERA), Vicor, Microchip, Texas Instruments, Analog Devices, Mini-Circuits, Amphenol, Glenair.

Сотрудничество с глобальными дистрибьюторами электронных компонентов, предоставляет возможность заказывать и получать с международных складов практически любой перечень компонентов в оптимальные для Вас сроки.

На всех этапах разработки и производства наши партнеры могут получить квалифицированную поддержку опытных инженеров.

Система менеджмента качества компании отвечает требованиям в соответствии с ГОСТ Р ИСО 9001, ГОСТ РВ 0015-002 и ЭС РД 009

### Офис по работе с юридическими лицами:

105318, г.Москва, ул.Щербаковская д.3, офис 1107, 1118, ДЦ «Щербаковский»

Телефон: +7 495 668-12-70 (многоканальный)

Факс: +7 495 668-12-70 (доб.304)

E-mail: [info@moschip.ru](mailto:info@moschip.ru)

Skype отдела продаж:

moschip.ru

moschip.ru\_4

moschip.ru\_6

moschip.ru\_9