

350mW, SMD Switching Diode

FEATURES

- Designed for mounting on small surface
- Low Capacitance
- Low forward voltage drop
- Compliant to RoHS directive 2011/65/EU and in accordance to WEEE 2002/96/EC
- Halogen-free according to IEC 61249-2-21

APPLICATIONS

- Switching mode power supply (SMPS)
- Adapters
- Lighting application
- On-board DC/DC converter

MECHANICAL DATA

- Case: SOT-23
- Molding compound meets UL 94 V-0 flammability rating
- Moisture sensitivity level: level 1, per J-STD-020
- Packing code with suffix "G" means green compound (halogen-free)
- Terminal: Matte tin plated leads, solderable per J-STD-002
- Meet JESD 201 class 1A whisker test
- Polarity: Indicated by cathode band
- Weight: 8 mg (approximately)

KEY PARAMETERS		
PARAMETER	VALUE	UNIT
$I_{F(AV)}$	200	mA
V_{RRM}	100	V
I_{FSM}	2	A
V_F at $I_F=10mA$	1	V
T_J Max.	150	°C
Package	SOT-23	
Configuration	Single dice	



ABSOLUTE MAXIMUM RATINGS ($T_A=25^{\circ}C$ unless otherwise noted)				
PARAMETER		SYMBOL	PART NUMBER	UNIT
Marking code on the device	MMBD4148		5D	
	MMBD4148CA		A1	
	MMBD4148CC		A4	
	MMBD4148SE		A7	
Repetitive peak reverse voltage		V_{RRM}	75	V
Forward current		$I_{F(AV)}$	200	mA
Repetitive peak forward surge current		I_{FRM}	700	mA
Non-repetitive peak forward surge current	at $t=1\mu s$	I_{FSM}	2	A
	at $t=1s$		1	
Junction temperature range		T_J	-55 to +150	°C
Storage temperature range		T_{STG}	-55 to +150	°C

THERMAL PERFORMANCE			
PARAMETER	SYMBOL	LIMIT	UNIT
Junction-to-ambient thermal resistance	$R_{\theta JA}$	357	$^{\circ}\text{C/W}$

ELECTRICAL SPECIFICATIONS ($T_A = 25^{\circ}\text{C}$ unless otherwise noted)					
PARAMETER	CONDITIONS	SYMBOL	MIN	MAX	UNIT
Forward voltage per diode ⁽¹⁾	$I_F = 10\text{mA}, T_J = 25^{\circ}\text{C}$	V_F	-	1.0	V
Reverse current @ rated V_R per diode ⁽²⁾	$V_R = 20\text{V}, T_J = 25^{\circ}\text{C}$	I_R	-	25.0	nA
	$V_R = 75\text{V}, T_J = 25^{\circ}\text{C}$		-	5.0	μA
	$V_R = 20\text{V}, T_A = 150^{\circ}\text{C}$		-	50.0	
Reverse breakdown voltage	$I_R = 5\mu\text{A}, T_J = 25^{\circ}\text{C}$	$V_{(BR)}$	75	-	V
	$I_R = 100\mu\text{A}, T_J = 25^{\circ}\text{C}$		100	-	
Junction capacitance	1 MHz, $V_R = 0\text{V}$	C_J	-	4.0	pF
Reverse recovery time	$I_F = 10\text{mA}, I_R = 1\text{mA}, R_L = 100\Omega, V_R = 6\text{V}$	t_{rr}	-	4.0	ns

Notes:

1. Pulse test with $PW = 0.3\text{ ms}$
2. Pulse test with $PW = 30\text{ ms}$

ORDERING INFORMATION				
PART NO.	PACKING CODE	PACKING CODE SUFFIX	PACKAGE	PACKING
MMBD414X (Note 1&2)	RF	G	SOT-23	3K / 7" Reel
	R5			10K / 13" Reel

Notes:

1. Whole series with green compound
2. "XX" is Device code from "8" to "8SE".

EXAMPLE				
EXAMPLE P/N	PART NO.	PACKING CODE	PACKING CODE SUFFIX	DESCRIPTION
MMBD4148 RFG	MMBD4148	RF	G	Green compound

CHARACTERISTICS CURVES

($T_A = 25^\circ\text{C}$ unless otherwise noted)

Fig. 1 Power Derating Curve

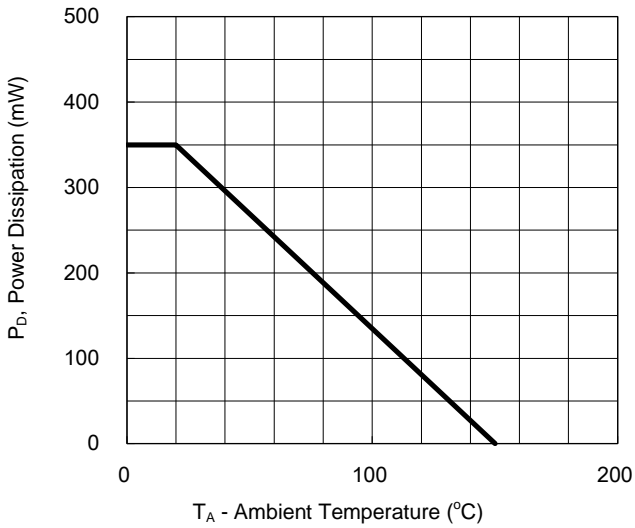

Fig.2 Forward Characteristics

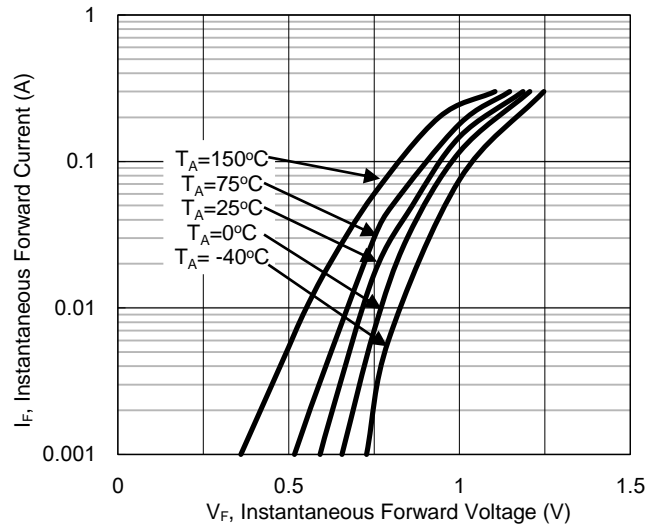

Fig.3 Typical Reverse Characteristics

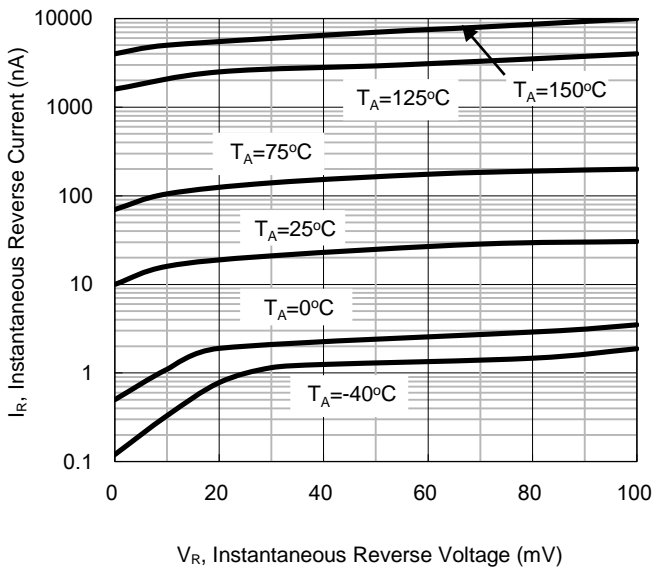
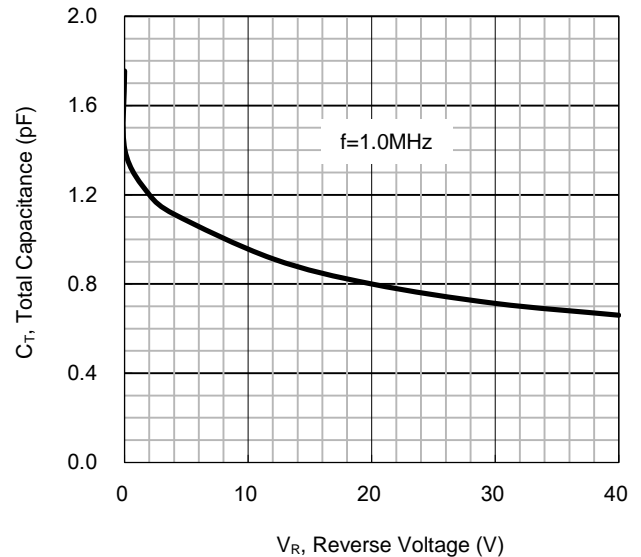
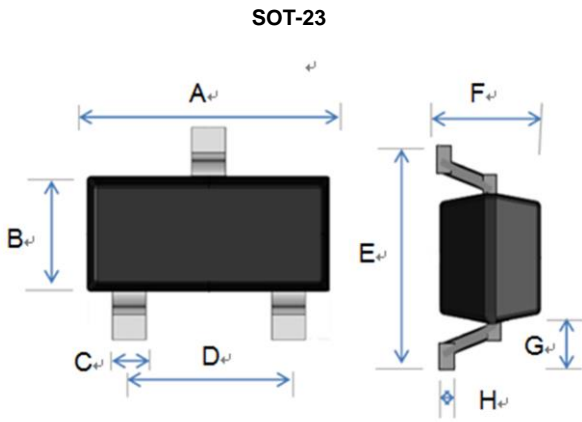

Fig.4 Typical Capacitance vs. Reverse Voltage



PACKAGE OUTLINE DIMENSION



DIM.	Unit(mm)		Unit(inch)	
	Min	Max	Min	Max
A	2.70	3.10	0.106	0.122
B	1.10	1.50	0.043	0.059
C	0.30	0.51	0.012	0.020
D	1.78	2.04	0.070	0.080
E	2.10	2.64	0.083	0.104
F	0.89	1.30	0.035	0.051
G	0.55 REF		0.022 REF	
H	0.10 REF		0.004 REF	

SUGGEST PAD LAYOUT

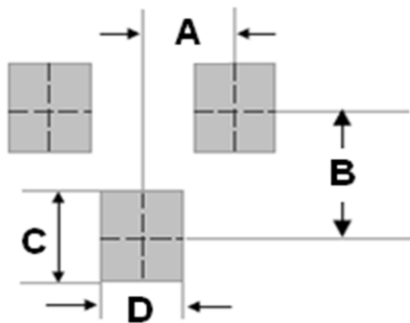

DIM.	Unit(mm)	Unit(inch)
	TYP	TYP
A	0.95	0.037
B	2.00	0.079
C	0.90	0.035
D	0.80	0.031

PIN CONFIGURATION

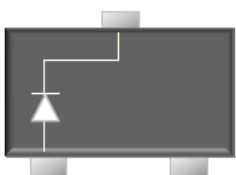

MMBD4148

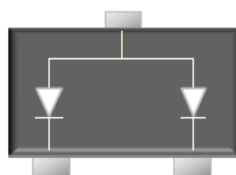

MMBD4148CA

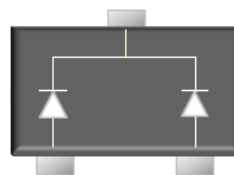

MMBD4148CC

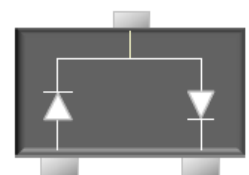

MMBD4148SE

Notice

Specifications of the products displayed herein are subject to change without notice. TSC or anyone on its behalf, assumes no responsibility or liability for any errors or inaccuracies.

Information contained herein is intended to provide a product description only. No license, express or implied, to any intellectual property rights is granted by this document. Except as provided in TSC's terms and conditions of sale for such products, TSC assumes no liability whatsoever, and disclaims any express or implied warranty, relating to sale and/or use of TSC products including liability or warranties relating to fitness for a particular purpose, merchantability, or infringement of any patent, copyright, or other intellectual property right.

The products shown herein are not designed for use in medical, life-saving, or life-sustaining applications. Customers using or selling these products for use in such applications do so at their own risk and agree to fully indemnify TSC for any damages resulting from such improper use or sale.

Данный компонент на территории Российской Федерации

Вы можете приобрести в компании MosChip.

Для оперативного оформления запроса Вам необходимо перейти по данной ссылке:

<http://moschip.ru/get-element>

Вы можете разместить у нас заказ для любого Вашего проекта, будь то серийное производство или разработка единичного прибора.

В нашем ассортименте представлены ведущие мировые производители активных и пассивных электронных компонентов.

Нашей специализацией является поставка электронной компонентной базы двойного назначения, продукции таких производителей как XILINX, Intel (ex.ALTERA), Vicor, Microchip, Texas Instruments, Analog Devices, Mini-Circuits, Amphenol, Glenair.

Сотрудничество с глобальными дистрибьюторами электронных компонентов, предоставляет возможность заказывать и получать с международных складов практически любой перечень компонентов в оптимальные для Вас сроки.

На всех этапах разработки и производства наши партнеры могут получить квалифицированную поддержку опытных инженеров.

Система менеджмента качества компании отвечает требованиям в соответствии с ГОСТ Р ИСО 9001, ГОСТ РВ 0015-002 и ЭС РД 009

Офис по работе с юридическими лицами:

105318, г.Москва, ул.Щербаковская д.3, офис 1107, 1118, ДЦ «Щербаковский»

Телефон: +7 495 668-12-70 (многоканальный)

Факс: +7 495 668-12-70 (доб.304)

E-mail: info@moschip.ru

Skype отдела продаж:

moschip.ru

moschip.ru_4

moschip.ru_6

moschip.ru_9