

Pushbutton Switches, Tiny, Process Sealed, Straight

SEE PAGE D6 FOR PRODUCT SPECIFICATIONS

* Refer to Page D6 for Additional Options *

SPST/SPDT



TPB11CGPCES



TPC11CGPCES

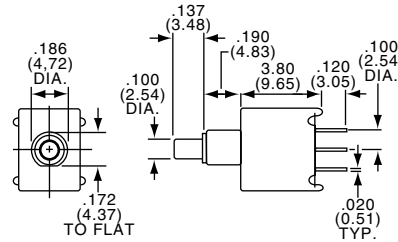

TPB SERIES

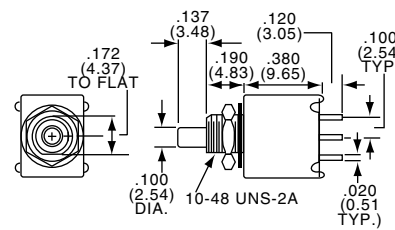

TPC SERIES

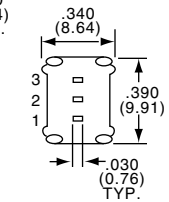

Model	Type	Act. Code	P. M6	Action	Bushing Dia.	Contact Type
TPB11CGPCES(*)	SPST	C		N.O. Momentary	.188	Gold
TPB11FGPCES(*)	SPDT	F		Momentary	.188	Gold
TPC11CGPCES(*)	SPST	C		N.O. Momentary	10-48	Gold
TPC11FGPCES(*)	SPDT	F		Momentary	10-48	Gold

(*) Specify button color by adding suffix number: (0) Black, (2) Red.
Note: No center terminal on "C" action switch.

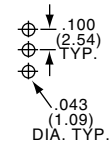

DPST/DPDT



TPB21RGPCEs

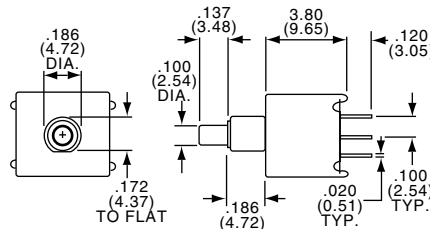

TPB SERIES

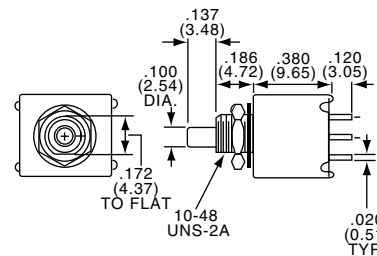

TPC SERIES

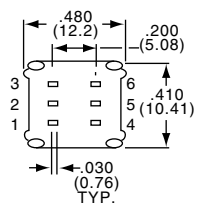

Model	Type	Act. Code	P. M6	Action	Bushing Dia.	Contact Type
TPB21MGPCEs(*)	DPST	M		N.O. Momentary	.188	Gold
TPB21RGPCEs(*)	DPDT	R		Momentary	.188	Gold
TPC21MGPCEs(*)	DPST	M		N.O. Momentary	10-48	Gold
TPC21RGPCEs(*)	DPDT	R		Momentary	10-48	Gold

(*) Specify button color by adding suffix number: (0) Black, (2) Red.
Note: No center terminal on "M" action switch.

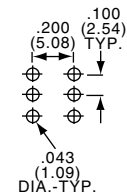

SPST/SPDT



TPD11CGPCES



TPF11CGPCES

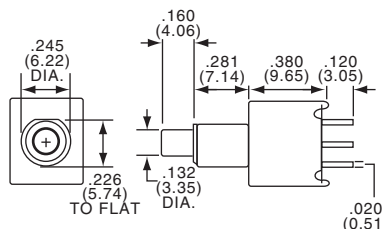

TPD SERIES

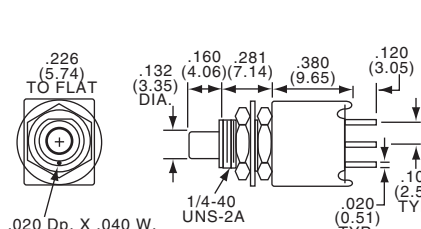

TPF SERIES

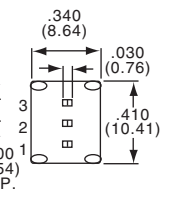

Model	Type	Act. Code	P. M6	Action	Bushing Dia.	Contact Type
TPD11CGPCES(*)	SPST	C		N.O. Momentary	.250	Gold
TPD11FGPCES(*)	SPDT	D		Momentary	.250	Gold
TPF11CGPCES(*)	SPST	C		N.O. Momentary	.250	Gold
TPF11FGPCES(*)	SPDT	F		Momentary	.250	Gold

(*) Specify button color by adding suffix number: (0) Black, (2) Red.
Note: No center terminal on "C" action switch.

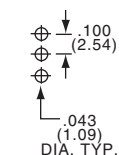

Pushbutton Switches, Tiny, Process Sealed, Straight or Right Angle

SEE PAGE D6 FOR PRODUCT SPECIFICATIONS

DPST/DPDT

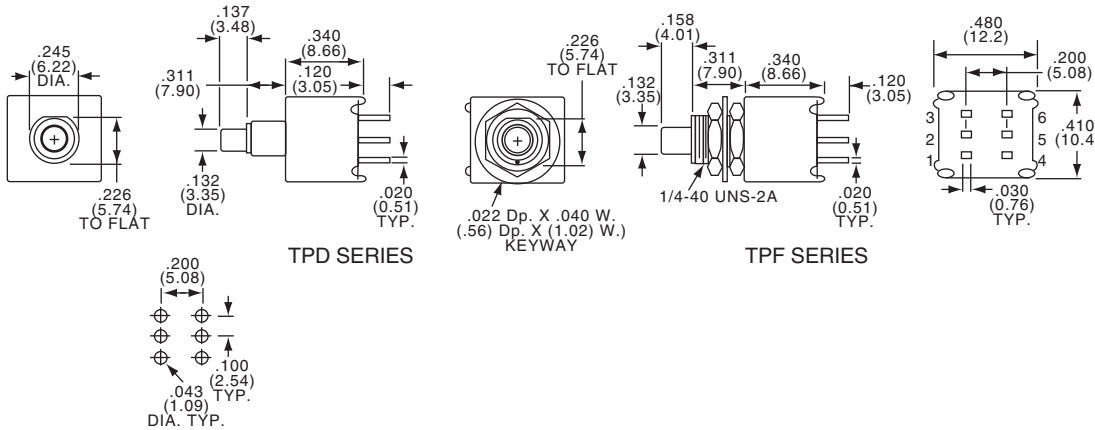

TPD21MGPCES

Model	Type	Act. Code	P. M6	Action	Bushing Dia.	Contact Type
TPD21MGPCES(*)	DPST	M		N.O. Momentary	.250	Gold
TPD21RGPCES(*)	DPDT	R		Momentary	.250	Gold
TPF21MGPCES(*)	DPST	M		N.O. Momentary	1/4-40	Gold
TPF21RGPCES(*)	DPDT	R		Momentary	1/4-40	Gold

(*) Specify button color by adding suffix number: (0) Black, (2) Red.
Note: No center terminal on "M" action switch.

SPST/SPDT

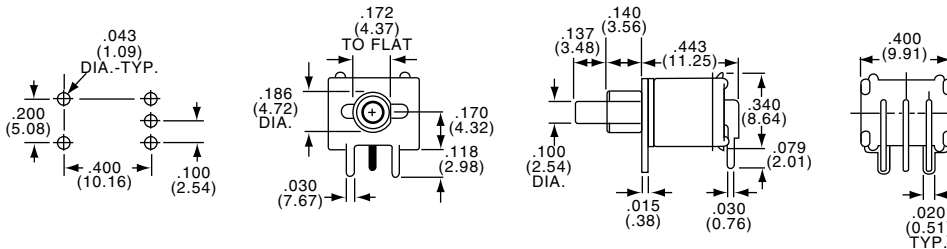

TPB11CGRAES

Model	Type	Act. Code	P. M6	Action	Bushing Dia.	Contact Type
TPB11CGRAES(*)	SPST	C		N.O. Momentary	.188	Gold
TPB11FGRAES(*)	SPDT	F		Momentary	.188	Gold

(*) Specify button color by adding suffix number: (0) Black, (2) Red.
Note: No center terminal on "C" action switch.

DPST/DPDT

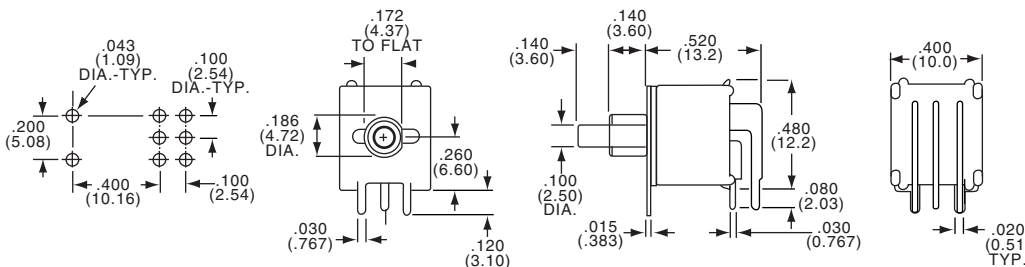

Model	Type	Act. Code	P. M6	Action	Bushing Dia.	Contact Type
TPB21MGRRAES(*)	DPST	M		N.O. Momentary	.188	Gold
TPB21RGRRAES(*)	DPDT	R		Momentary	.188	Gold

(*) Specify button color by adding suffix number: (0) Black, (2) Red.
Note: No center terminal on "M" action switch.

D
TP-ES Series

Pushbutton Switches, Tiny, Process Sealed, Flush Actuator, Straight or Right Angle

SEE PAGE D6 FOR PRODUCT SPECIFICATIONS

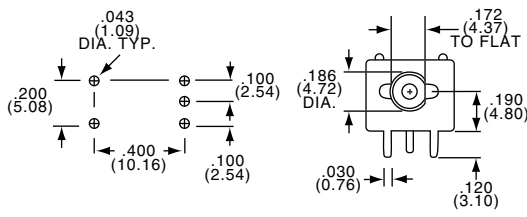

TPBF Series

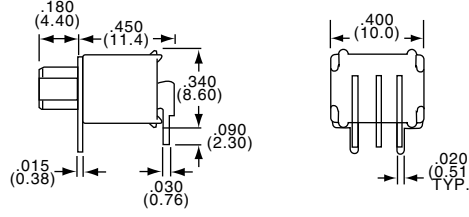

SPST/SPDT



TPBF11CGRAESO

Model	Type	Act. Code P. M6	Action
TPBF11CGRAES(*)	SPST	C	N.O. Momentary
TPBF11FGRAES(*)	SPDT	F	Momentary

(*) Specify button color by adding suffix numbers: (0) Black, (2) Red.

Note: No center terminal on "C" Action switches.

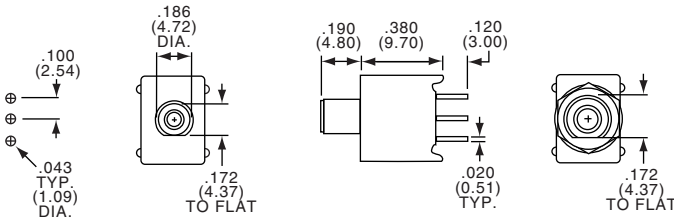

TPBF Series

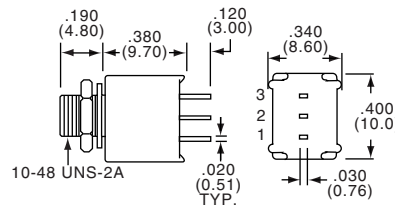

TPCF Series

SPST/SPDT



TPBF11CGPCES

Model	Type	Act. Code P. M6	Action
TPBF11CGPCES(*)	SPST	C	N.O. Momentary
TPBF11FGPCES(*)	SPDT	F	Momentary
TPCF11FGPCES(*)	SPDT	F	Momentary

(*) Specify button color by adding suffix numbers: (0) Black, (2) Red.
Note: No center terminal on "C" action switch.

Данный компонент на территории Российской Федерации

Вы можете приобрести в компании MosChip.

Для оперативного оформления запроса Вам необходимо перейти по данной ссылке:

<http://moschip.ru/get-element>

Вы можете разместить у нас заказ для любого Вашего проекта, будь то серийное производство или разработка единичного прибора.

В нашем ассортименте представлены ведущие мировые производители активных и пассивных электронных компонентов.

Нашей специализацией является поставка электронной компонентной базы двойного назначения, продукции таких производителей как XILINX, Intel (ex.ALTERA), Vicor, Microchip, Texas Instruments, Analog Devices, Mini-Circuits, Amphenol, Glenair.

Сотрудничество с глобальными дистрибьюторами электронных компонентов, предоставляет возможность заказывать и получать с международных складов практически любой перечень компонентов в оптимальные для Вас сроки.

На всех этапах разработки и производства наши партнеры могут получить квалифицированную поддержку опытных инженеров.

Система менеджмента качества компании отвечает требованиям в соответствии с ГОСТ Р ИСО 9001, ГОСТ РВ 0015-002 и ЭС РД 009

Офис по работе с юридическими лицами:

105318, г.Москва, ул.Щербаковская д.3, офис 1107, 1118, ДЦ «Щербаковский»

Телефон: +7 495 668-12-70 (многоканальный)

Факс: +7 495 668-12-70 (доб.304)

E-mail: info@moschip.ru

Skype отдела продаж:

moschip.ru

moschip.ru_4

moschip.ru_6

moschip.ru_9