



# Lattice Embedded Vision Development Kit

## User Guide

FPGA-UG-0215 Version 1.3

November 2018

## Contents

|   |    |
|---|----|
| Acronyms in This Document .....   | 4  |
| 1. Introduction .....   | 5  |
| 2. Functional Description .....   | 6  |
| 2.1. CrossLink .....  | 6  |
| 2.2. ECP5.....  | 7  |
| 2.3. Sil1136.....   | 7  |
| 3. Demo Requirements .....  | 8  |
| 3.1. CrossLink VIP Input Bridge Board .....                               | 9  |
| 3.2. ECP5 VIP Processor Board .....                                       | 11 |
| 3.3. HDMI VIP Output Bridge Board .....                                   | 13 |
| 4. Jumper Settings .....  | 15 |
| 5. Demo Procedure .....   | 15 |
| 6. Demo Package Directory Structure.....                                  | 16 |
| 7. Pinout Information .....   | 17 |
| 7.1. CrossLink .....  | 17 |
| 7.2. ECP5.....  | 18 |
| 8. Ordering Information.....  | 19 |
| References .....  | 20 |
| Technical Support .....   | 20 |
| Appendix A. Lattice Embedded Vision Development Kit Setup.....            | 21 |
| Appendix B. Programming the Lattice Embedded Vision Development Kit ..... | 22 |
| Using Diamond Programmer with the EVDK .....                              | 22 |
| ECP5 SPI Flash Programming .....  | 22 |
| Erasing the ECP5 Prior to Reprogramming .....                             | 22 |
| Programming the SPI on the ECP5 VIP Processor Board .....                 | 23 |
| CrossLink SPI Flash Programming .....                                     | 26 |
| Erasing the CrossLink FPGA Prior to Reprogramming.....                    | 26 |
| Programming the SPI on the CrossLink VIP Input Bridge Board .....         | 27 |
| Troubleshooting CrossLink VIP Input Bridge Board Programming .....        | 28 |
| Revision History .....  | 29 |

## Figures

|   |    |
|---|----|
| Figure 2.1. 2:1 MIPI CSI-2 to HDMI Bridge System Diagram.....             | 6  |
| Figure 2.2. CrossLink Functional Block Diagram .....                      | 6  |
| Figure 2.3. ECP5 Functional Block Diagram .....                           | 7  |
| Figure 2.4. Sil1136 Functional Block Diagram .....                        | 7  |
| Figure 3.1. Dual Camera to HDMI Setup.....                                | 8  |
| Figure 3.2. Top and Bottom View of CrossLink VIP Input Bridge Board ..... | 10 |
| Figure 3.3. Top and Bottom View of ECP5 VIP Processor Board .....         | 12 |
| Figure 3.4. Top and Bottom View of HDMI VIP Output Board .....            | 14 |
| Figure 5.1. Dual Camera Merged Image .....                                | 15 |
| Figure B.1. Create a New Blank Project .....                              | 22 |
| Figure B.2. Selecting Device.....   | 23 |
| Figure B.3. Device Operation .....  | 23 |
| Figure B.4. Device Properties.....  | 24 |
| Figure B.5. Output Console.....   | 25 |
| Figure B.6. Select Device.....  | 26 |
| Figure B.7. Device Operation .....  | 26 |
| Figure B.8. Device Properties.....  | 27 |
| Figure B.9. Output Console.....   | 28 |

## Tables

|  |    |
|--|----|
| Table 4.1. CrossLink VIP Input Bridge Board.....   | 15 |
| Table 4.2. ECP5 VIP Processor Board.....           | 15 |
| Table 7.1. CrossLink Pinouts .....                 | 17 |
| Table 7.2. ECP5 Pinouts .....                      | 18 |
| Table 8.1. Ordering Information.....               | 19 |
| Table B.1. SPI Flash Options Selection Guide ..... | 24 |
| Table B.2. SPI Flash Options Selection Guide ..... | 27 |

## Acronyms in This Document

A list of acronyms used in this document.

| Acronym          | Definition                           |
|------------------|--------------------------------------|
| CSI              | Camera Serial Interface              |
| EVDK             | Embedded Vision Development Kit      |
| GPIO             | General Purpose Input/Output         |
| HDMI             | High Definition Multimedia Interface |
| I <sup>2</sup> C | Inter-Integrated Circuit             |
| MIPI             | Mobile Industry Processing Interface |
| VIP              | Video Interface Platform             |
| USB              | Universal Serial Bus                 |

# 1. Introduction

This document describes the design and setup procedure for the Lattice Embedded Vision Development Kit (EVDK) to demonstrate dual CSI-2 camera to High Definition Multimedia Interface (HDMI®) bridging that features the CrossLink™, FPGA, ECP5™ FPGA and Si1136 transmitter devices.

Figure 2.1 shows the Lattice Embedded Vision Development Kit that is designed as a stackable modular architecture with 80 mm × 80 mm form factor. The Lattice Embedded Vision Development Kit consists of three boards:

- CrossLink Video Interface Platform (VIP) Input Bridge Board
- ECP5 VIP Processor Board
- HDMI VIP Output Bridge Board

The figures shown in this document are of the Revision C version of the Embedded Vision Development Kit, for earlier versions refer to the individual evaluation board's user guide. For more information on Embedded Vision Development Kit, visit [www.latticesemi.com/en/Products/DevelopmentBoardsAndKits/EmbeddedVisionDevelopmentKit.aspx](http://www.latticesemi.com/en/Products/DevelopmentBoardsAndKits/EmbeddedVisionDevelopmentKit.aspx)

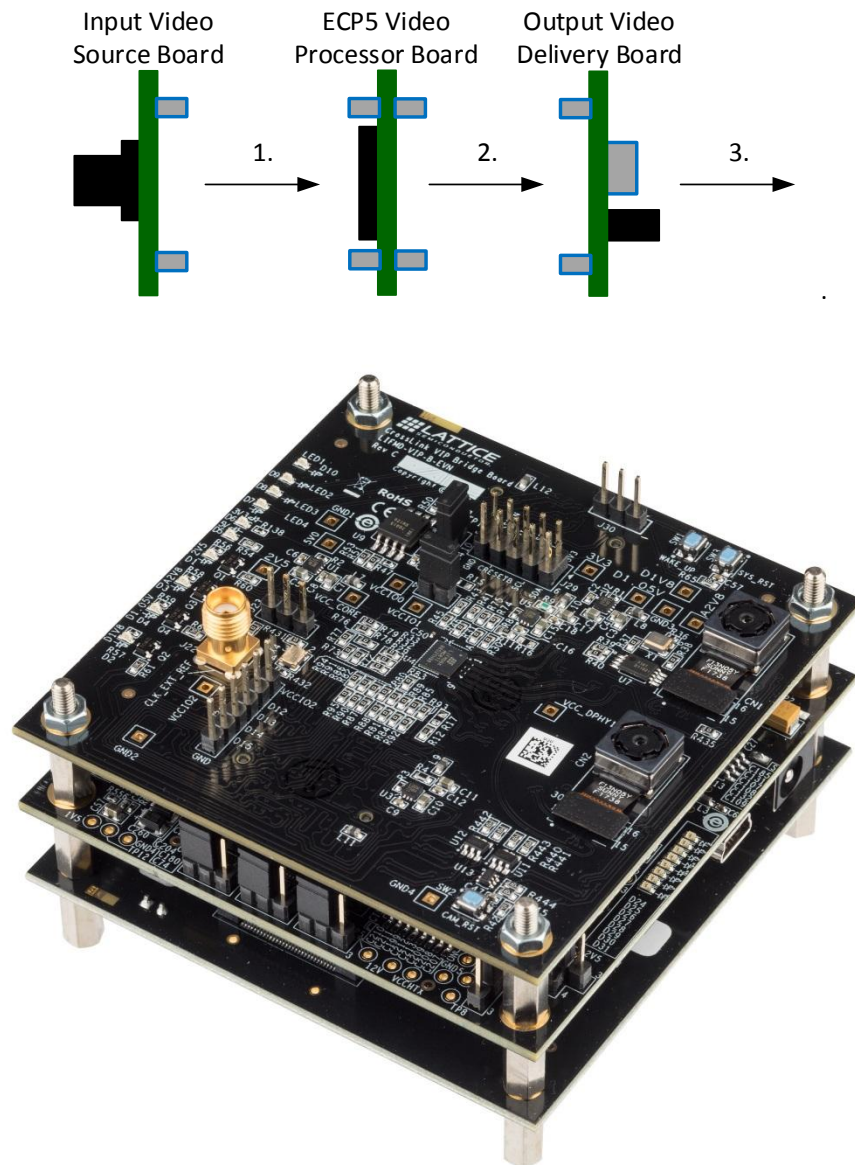

Figure 1.1. 2:1 MIPI CSI-2 to HDMI Bridge

## 2. Functional Description

The dual camera Mobile Industry Processing Interface (MIPI<sup>®</sup>) CSI-2 to HDMI demo uses a Sony IMX214 camera to output 1080p video over four MIPI data lanes, each running at 371.25 Mb/s. CrossLink VIP input bridge board receives the MIPI video stream from onboard camera sensor and extracts the video pixels. These video pixels from two cameras are merged side by side and the combined image data is transmitted to ECP5 in the form of parallel CMOS interface on the ECP5 video processor board through board-to-board connectors.

The ECP5 FPGA processes the merged sensor image and sends processed parallel image data to the Sil1136 HDMI transmitter on the HDMI VIP output bridge board through board to board connectors. The Sil1136 chip transmits the video data via HDMI to the 1080p display.

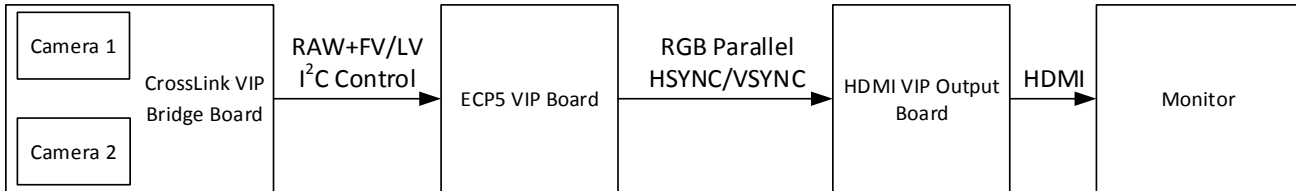

Figure 2.1. 2:1 MIPI CSI-2 to HDMI Bridge System Diagram

### 2.1. CrossLink

The dual-camera-to-parallel design receives the serial, source-synchronous MIPI data from two MPI CSI-2 cameras, reserializes the serial data into bytes and extracts the control signal from MIPI data packets. The byte data is sent to Byte to Pixel module which converts the byte data into RAW10 data. The two streams of RAW data are sent to the Image merger logic which combines the parallel data from both data streams and sends it to the ECP5 board. The onboard CSI-2 cameras are configured through the I<sup>2</sup>C master interface on ECP5 VIP processor board. Figure 2.2 shows the CrossLink functional block diagram.

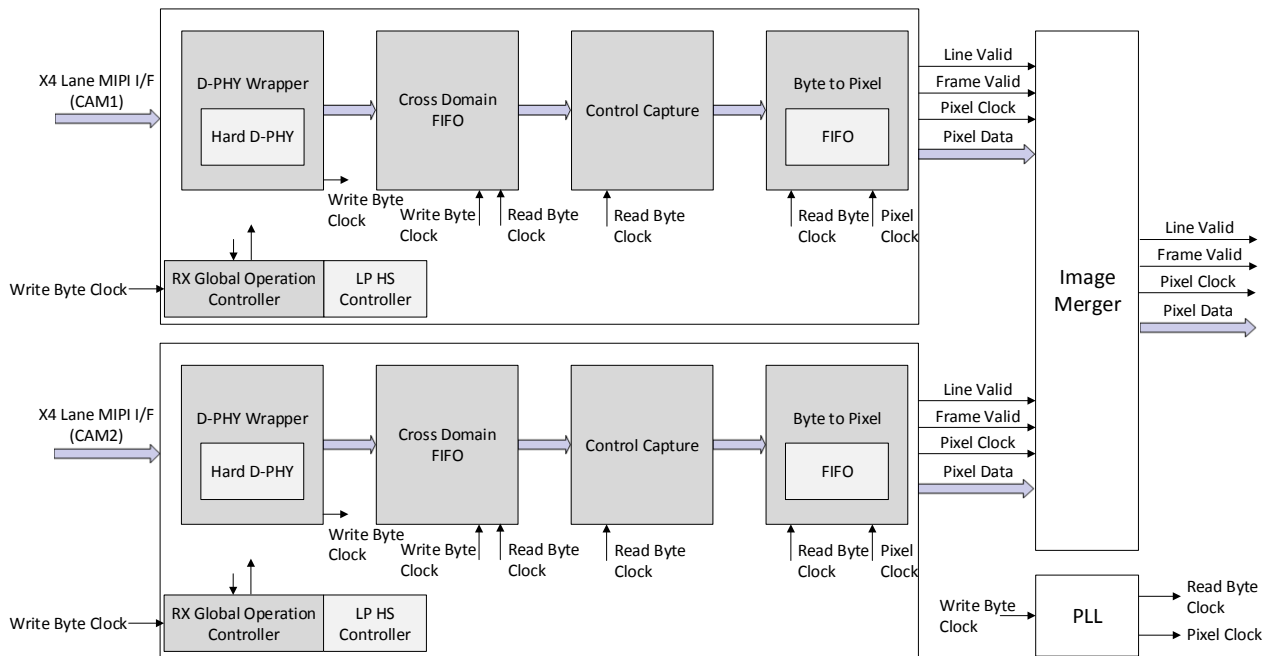

Figure 2.2. CrossLink Functional Block Diagram

## 2.2. ECP5

The ECP5 FPGA receives RAW10 data from CrossLink, does the fundamental image processing, and sends it to the HDMI board. Figure 2.3 shows the Lattice Programmable Image Processing Module. This module improves the quality of an image from a sensor by:

- **Auto Brightness** – The Auto Brightness module adjusts the intensity of incoming sensor data.
- **Debayer** – The Debayer converts the RAW10 Bayer data into separate red, green and blue pixels per clock cycle.
- **Color Space Converter** – Colors directly from an image sensor do not match the real world by default. The Color Space Converter matrix corrects this issue. There are gain and offset controls for each color, as well as the influence of one color on the other.
- **Gamma Correction** – Gamma Correction is a type of pre-distortion correction made to video frames to offset the non-linear behavior of display systems.

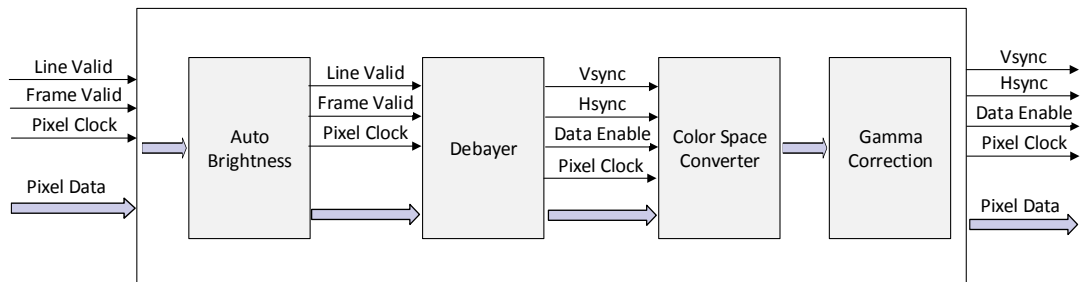

Figure 2.3. ECP5 Functional Block Diagram

## 2.3. SiI1136

Figure 2.4 shows the functional block diagram of the SiI1136 HDMI transmitter. This transmitter device is configured to output 1080p60 through the ECP5 I<sup>2</sup>C Master interface on ECP5 VIP processor board. It receives 36-bit RGB data and control signals from ECP5 and converts it to HDMI format that is displayed on the HDMI monitor.

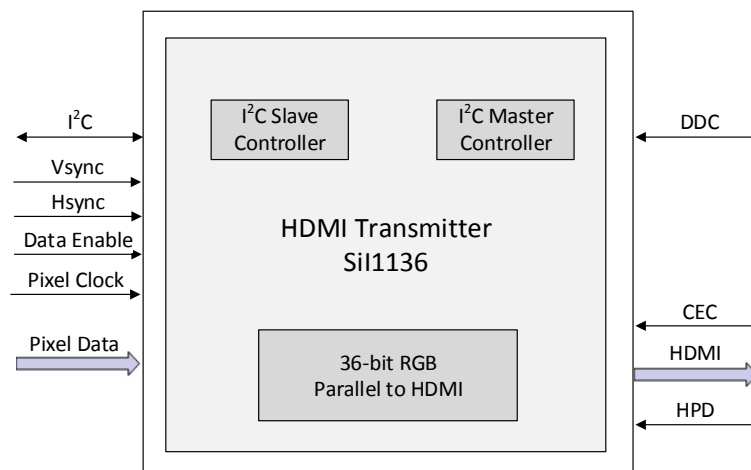

Figure 2.4. SiI1136 Functional Block Diagram

### 3. Demo Requirements

The following equipment is required for the demo:

- LF-EVDK1-EVN Demo Kit
- HDMI monitor
- HDMI cable
- DC power adapter (12 V)
- Laptop/PC
- Bit/JED file
- USB 2.0 Type A to Mini-B cable\*
- Lattice Diamond® Programmer version 3.7 or higher\*

\***Note:** Required only in re-programming.

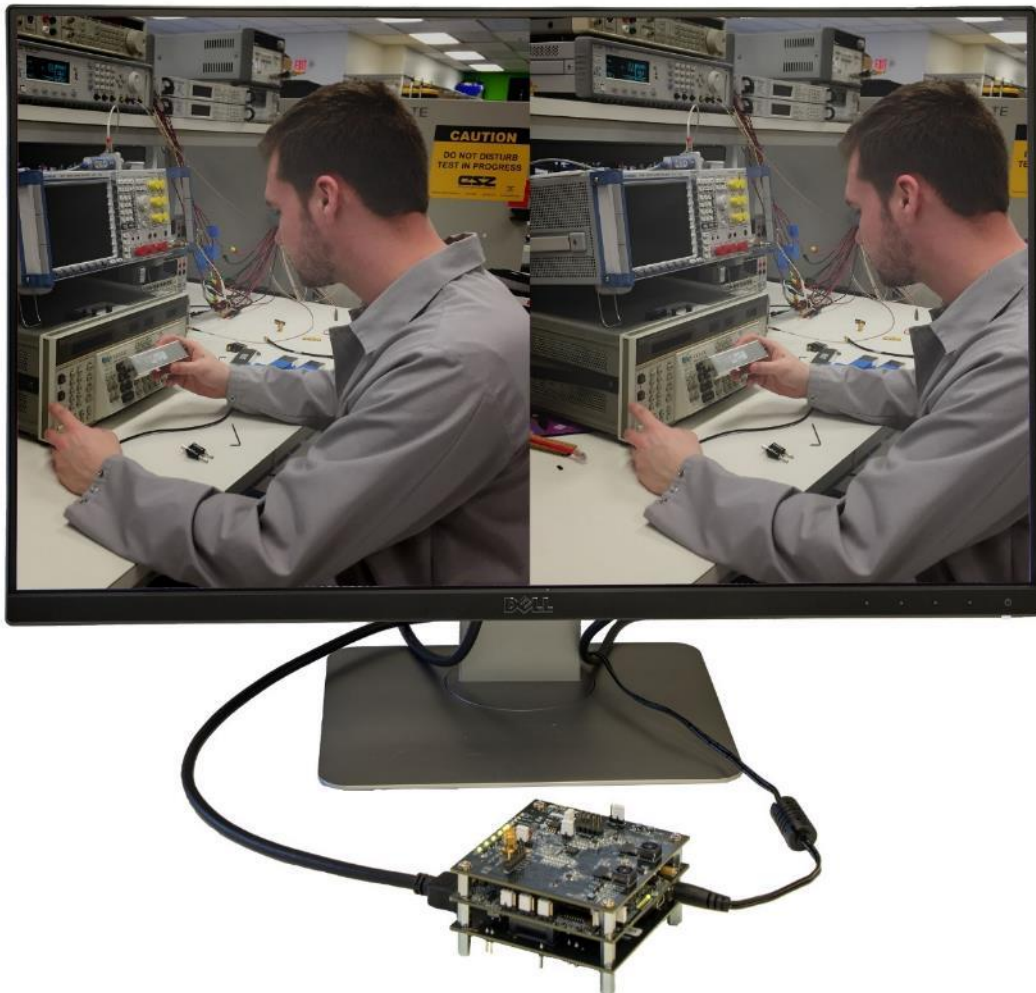

**Figure 3.1. Dual Camera to HDMI Setup**



### 3.1. CrossLink VIP Input Bridge Board

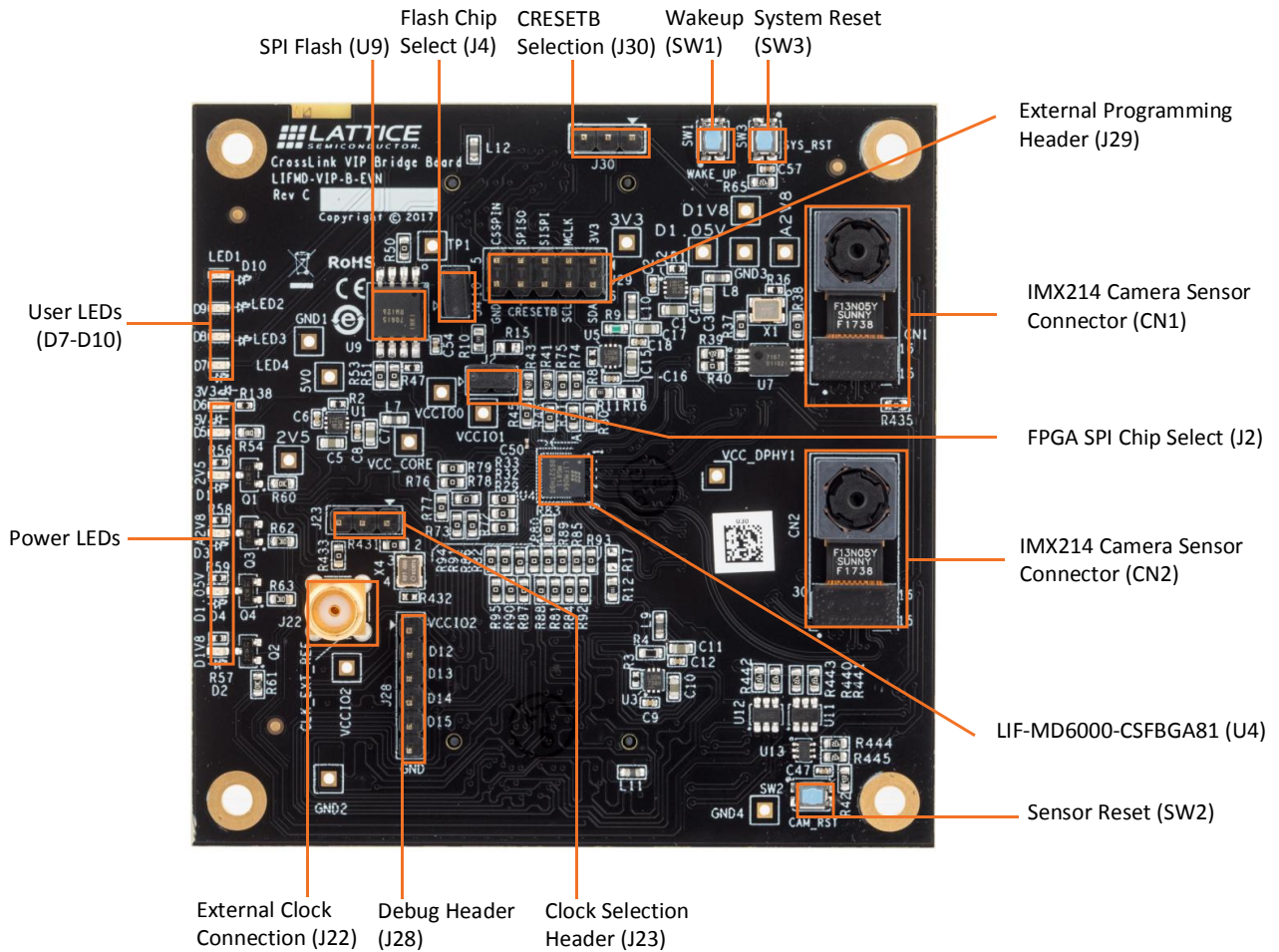

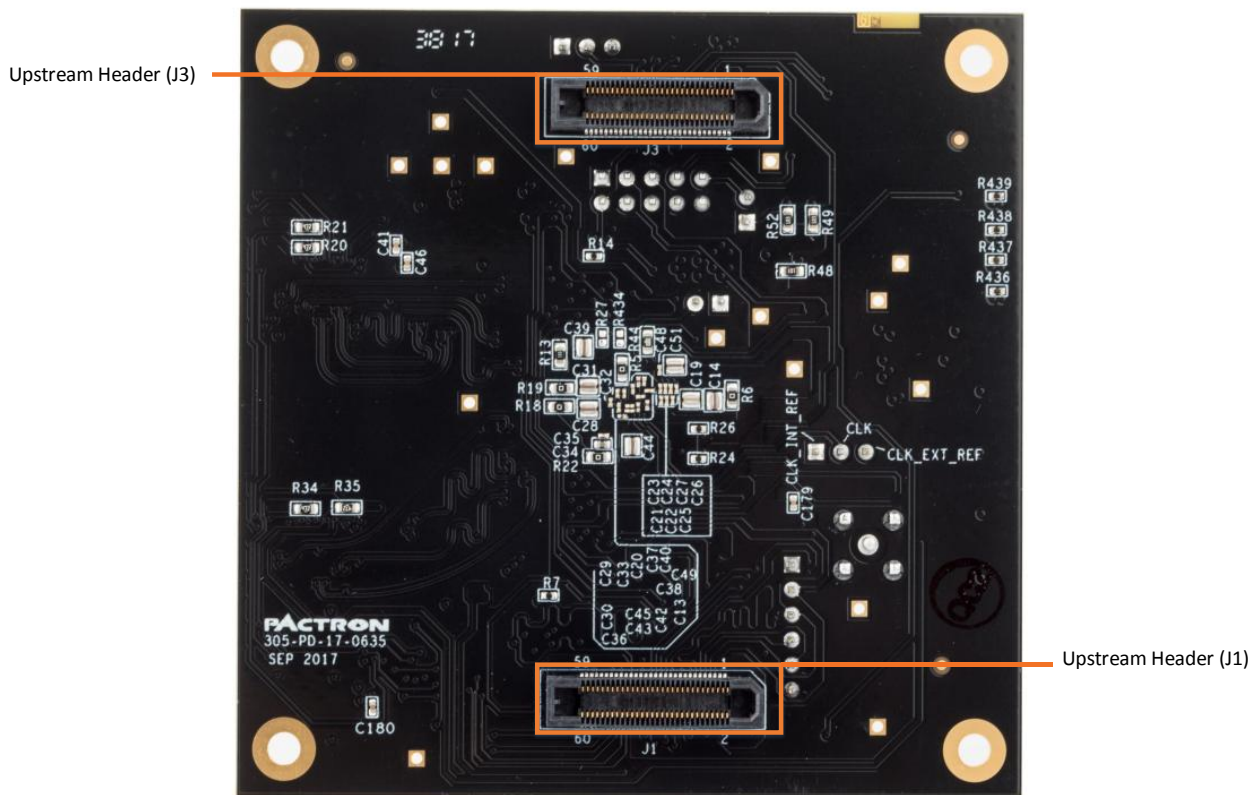
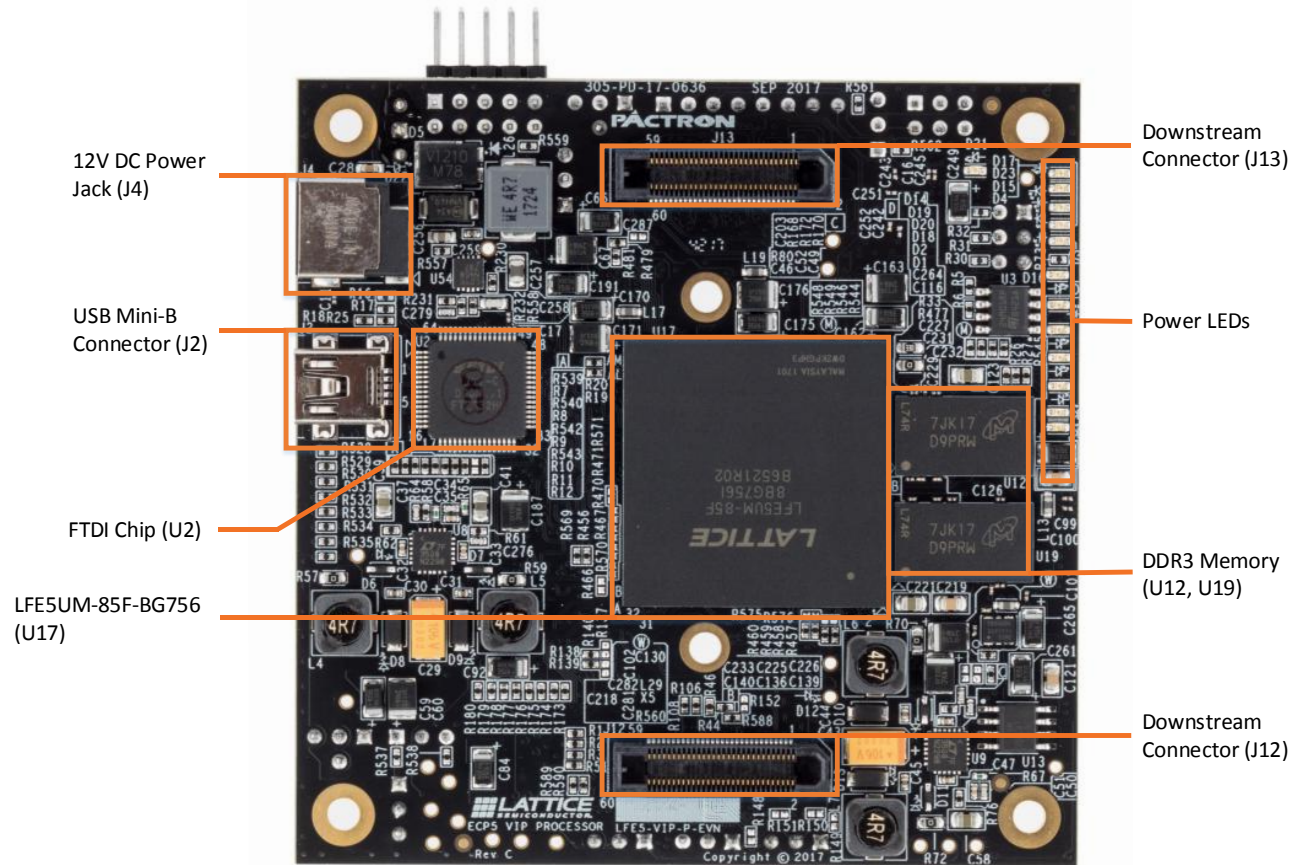
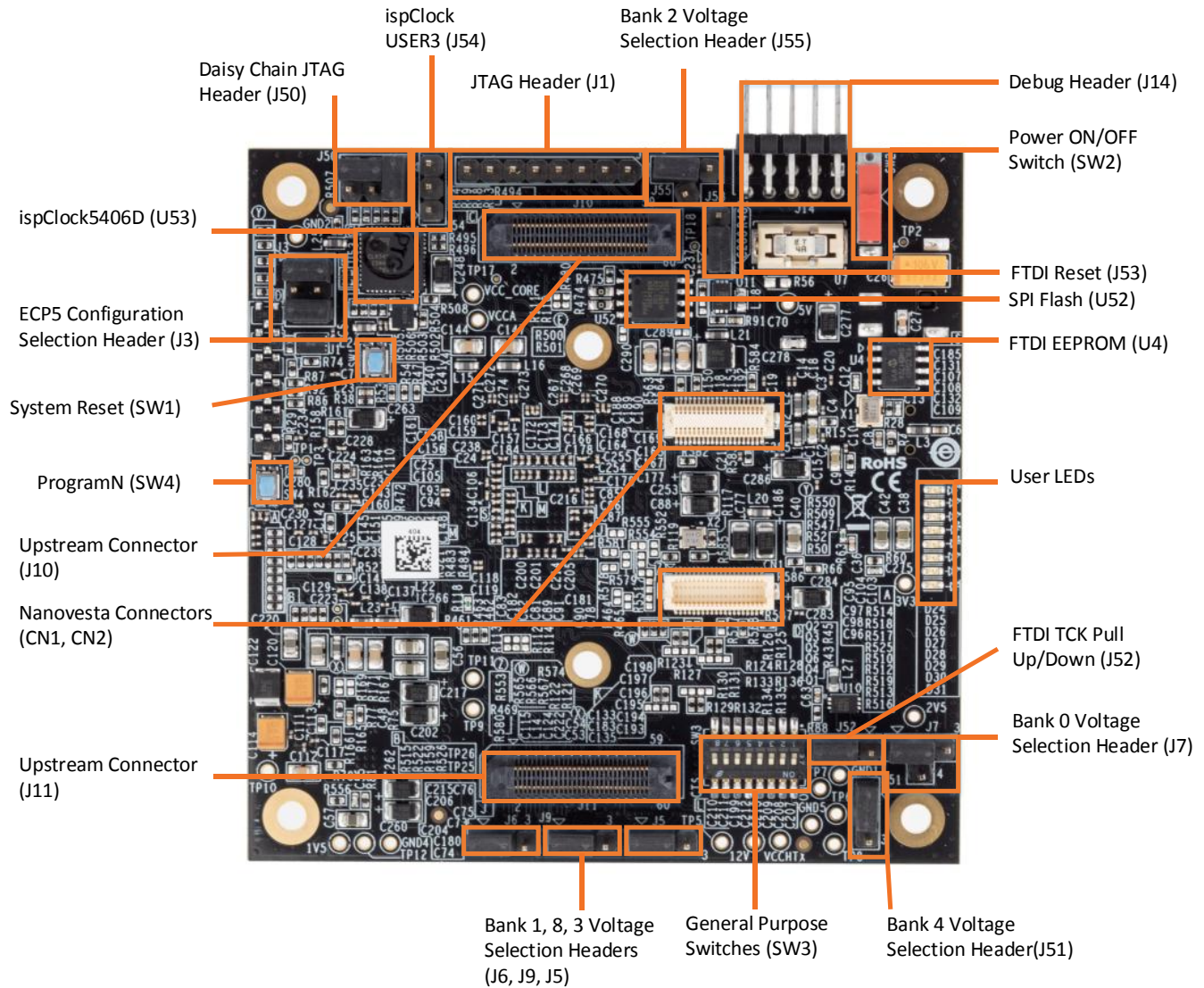

Figure 3.2. Top and Bottom View of CrossLink VIP Input Bridge Board

### 3.2. ECP5 VIP Processor Board





**Figure 3.3. Top and Bottom View of ECP5 VIP Processor Board**

### 3.3. HDMI VIP Output Bridge Board

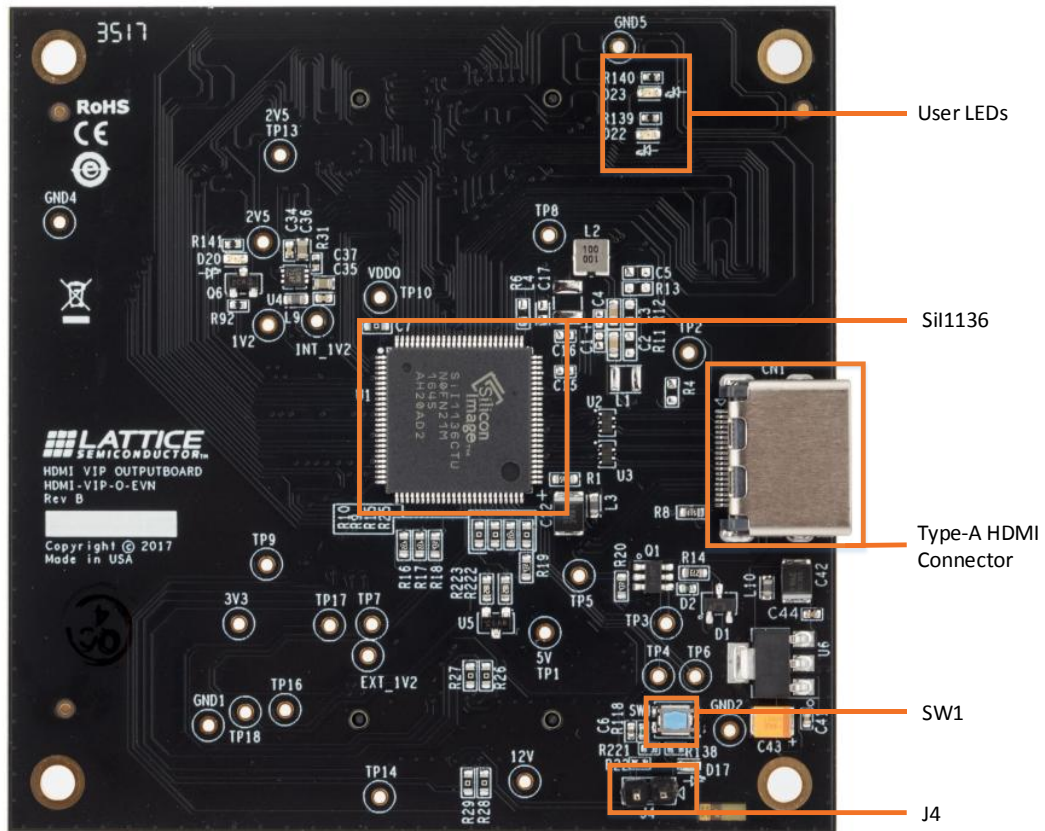

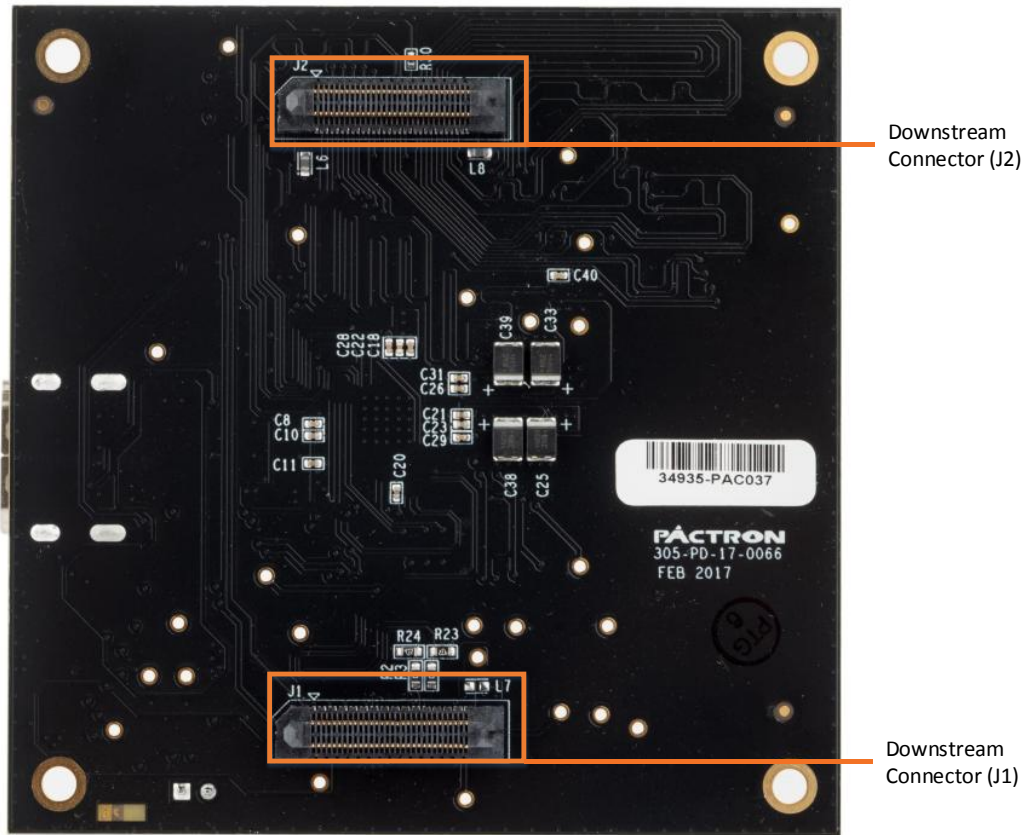

Figure 3.4. Top and Bottom View of HDMI VIP Output Board

## 4. Jumper Settings

**Table 4.1. CrossLink VIP Input Bridge Board**

| Jumper | Description               | Default                                |
|--------|---------------------------|--|
| J2     | CrossLink SPI Chip Select | Short                                  |
| J4     | SPI Flash Chip Select     | Short                                  |
| J30    | CRESETB selection         | Open                                   |
| —      | —                         | All other headers should be kept open. |

**Table 4.2. ECP5 VIP Processor Board**

| Jumper | Description                  | Default  |
|--------|------------------------------|--|
| J3     | ECP5 Configuration Selection | Connect 1 and 2 and connect 5 and 6 (Master SPI) |
| J5     | Bank 3 Voltage Selection     | Connect 1 and 2 (3.3 V)                          |
| J6     | Bank 1 Voltage Selection     | Connect 1 and 2 (3.3 V)                          |
| J7     | Bank 0 Voltage Selection     | Connect 2 and 3 (3.3 V)                          |
| J9     | Bank 8 Voltage Selection     | Connect 1 and 2 (3.3 V)                          |
| J50    | JTAG Daisy Chain             | Connect 1 and 2 and connect 3 and 5 (ECP5 Only)  |
| J51    | Bank 4 Voltage Selection     | Connect 1 and 2 (3.3 V)                          |
| J52    | FTDI TCK Pull Up/Down        | Connect 2 and 3 (JTAG)                           |
| J53    | FTDI Reset                   | Connect 1 and 2 (Pulled High)                    |
| J55    | Bank 2 Voltage               | Connect 2 and 3 (3.3 V)                          |
| —      | —                            | All other headers should be kept open.           |

## 5. Demo Procedure

To set up the demonstration:

1. Connect the ECP5 VIP processor board to the wall socket using 12 V power adapter.
2. Power up the demo kit by turning on SW2 on ECP5 VIP processor board.
3. Connect the HDMI cable from CN1 of HDMI VIP output board to the HDMI display/monitor. The monitor displays the dual camera merged image as shown in [Figure 5.1](#).

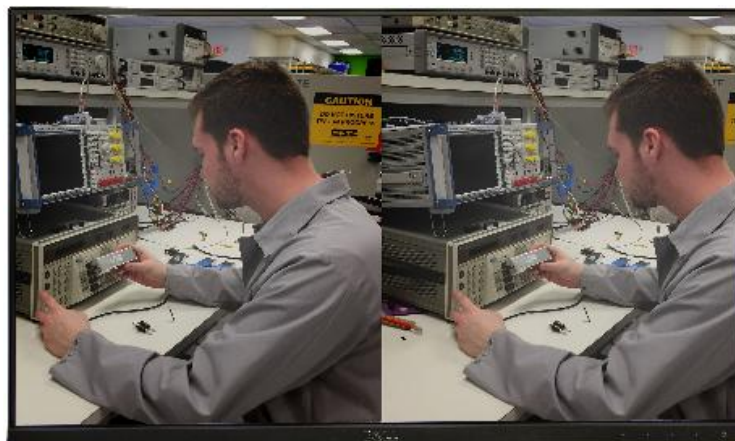

**Figure 5.1. Dual Camera Merged Image**

## 6. Demo Package Directory Structure

The key files and directories are listed below:

|   |                                   |
|---|-----------------------------------|
| ■ Dual_CSI-2_Camera_to_HDMI_Bridge_Demo | (Main directory)                  |
| ■ CrossLink_DualCSI2toRaw10             | (CrossLink design directory)      |
| ■ bitstream                             |                                   |
| 📄 DualCSI2toRaw10.bit                   | (CrossLink bitstream)             |
| ■ source                                | (CrossLink source files)          |
| 📄 DualCSI2toRaw10.lfd                   | (CrossLink Diamond Project File)  |
| 📄 DualCSI2toRaw10.lpf                   | (CrossLink Project Settings File) |
| 📄 DualCSI2toRaw101.sty                  | (CrossLink Project Strategy File) |
| ■ ECP5_Raw10toParallel                  | (ECP5 design directory)           |
| ■ bitstream                             |                                   |
| 📄 Raw10toParallel.bit                   | (ECP5 bitstream)                  |
| ■ source                                | (ECP5 source files)               |
| 📄 Raw10toParallel.lfd                   | (ECP5 Diamond Project File)       |
| 📄 Raw10toParallel.lpf                   | (ECP5 Project Settings File)      |
| 📄 Raw10toParallel1.sty                  | (ECP5 Project Strategy File)      |



## 7. Pinout Information

### 7.1. CrossLink

Table 7.1 lists the CrossLink pinouts used for the demo.

Table 7.1. CrossLink Pinouts

| Port Name                      | Pin | Bank | Buffer Type   | Site      | Properties                          |
|--------------------------------|-----|------|---------------|-----------|-------------------------------------|
| reset_n_i                      | J4  | 1    | LVC MOS33_IN  | PB38C     | Pull: Up, Clamp: On, Hysteresis: On |
| <b>Camera Sensor Interface</b> |     |      |               |           |                                     |
| clk_p_i                        | A1  | 61   | DPHY_BIDI     | DPHY1_CKP | —                                   |
| clk_n_i                        | A2  | 61   | DPHY_BIDI     | DPHY1_CKN | —                                   |
| d0_p_i                         | B1  | 61   | DPHY_BIDI     | DPHY1_DP0 | —                                   |
| d0_n_i                         | B2  | 61   | DPHY_BIDI     | DPHY1_DN0 | —                                   |
| d1_p_i                         | A3  | 61   | DPHY_BIDI     | DPHY1_DP1 | —                                   |
| d1_n_i                         | B3  | 61   | DPHY_BIDI     | DPHY1_DN1 | —                                   |
| d2_p_i                         | C1  | 61   | DPHY_BIDI     | DPHY1_DP2 | —                                   |
| d2_n_i                         | C2  | 61   | DPHY_BIDI     | DPHY1_DN2 | —                                   |
| d3_p_i                         | A4  | 61   | DPHY_BIDI     | DPHY1_DP3 | —                                   |
| d3_n_i                         | B4  | 61   | DPHY_BIDI     | DPHY1_DN3 | —                                   |
| clk_p_i_s                      | A8  | 60   | DPHY_BIDI     | DPHY0_CKP | —                                   |
| clk_n_i_s                      | A9  | 60   | DPHY_BIDI     | DPHY0_CKN | —                                   |
| d0_p_i_s                       | B7  | 60   | DPHY_BIDI     | DPHY0_DP0 | —                                   |
| d0_n_i_s                       | A7  | 60   | DPHY_BIDI     | DPHY0_DN0 | —                                   |
| d1_p_i_s                       | B8  | 60   | DPHY_BIDI     | DPHY0_DP1 | —                                   |
| d1_n_i_s                       | B9  | 60   | DPHY_BIDI     | DPHY0_DN1 | —                                   |
| d2_p_i_s                       | B6  | 60   | DPHY_BIDI     | DPHY0_DP2 | —                                   |
| d2_n_i_s                       | A6  | 60   | DPHY_BIDI     | DPHY0_DN2 | —                                   |
| d3_p_i_s                       | C8  | 60   | DPHY_BIDI     | DPHY0_DP3 | —                                   |
| d3_n_i_s                       | C9  | 60   | DPHY_BIDI     | DPHY0_DN3 | —                                   |
| <b>ECP5 Interface</b>          |     |      |               |           |                                     |
| pixel_clk                      | J6  | 1    | LVC MOS33_OUT | PB29C     | Drive: 6 mA, Clamp: On              |
| fv                             | J3  | 1    | LVC MOS33_OUT | PB43C     | Drive: 6 mA, Clamp: On              |
| lv                             | H3  | 1    | LVC MOS33_OUT | PB43D     | Drive: 6 mA, Clamp: On              |
| pixdata[0]                     | F9  | 2    | LVC MOS33_OUT | PB2A      | Drive: 6 mA, Clamp: On              |
| pixdata[1]                     | F8  | 2    | LVC MOS33_OUT | PB2B      | Drive: 6 mA, Clamp: On              |
| pixdata[2]                     | G9  | 2    | LVC MOS33_OUT | PB2C      | Drive: 6 mA, Clamp: On              |
| pixdata[3]                     | G8  | 2    | LVC MOS33_OUT | PB2D      | Drive: 6 mA, Clamp: On              |
| pixdata[4]                     | E9  | 2    | LVC MOS33_OUT | PB6A      | Drive: 6 mA, Clamp: On              |
| pixdata[5]                     | E8  | 2    | LVC MOS33_OUT | PB6B      | Drive: 6 mA, Clamp: On              |
| pixdata[6]                     | H9  | 2    | LVC MOS33_OUT | PB6C      | Drive: 6 mA, Clamp: On              |
| pixdata[7]                     | H8  | 2    | LVC MOS33_OUT | PB6D      | Drive: 6 mA, Clamp: On              |
| pixdata[8]                     | F7  | 2    | LVC MOS33_OUT | PB12A     | Drive: 6 mA, Clamp: On              |
| pixdata[9]                     | E7  | 2    | LVC MOS33_OUT | PB12B     | Drive: 6 mA, Clamp: On              |

## 7.2. ECP5

Table 7.2 lists the ECP5 pinouts used for the demo.

**Table 7.2. ECP5 Pinouts**

| Port Name                      | Pin  | Bank | Buffer Type   | Site   | Properties                            |
|--------------------------------|------|------|---------------|--------|---------------------------------------|
| clk_i                          | E17  | 1    | LVC MOS33_IN  | —      | —                                     |
| reset_n                        | AH1  | 8    | LVC MOS33_IN  | PB4B   | Pull: Down, Clamp: On, Hysteresis: On |
| q                              | AG30 | 4    | LVC MOS33_OUT | PB114B | Drive:8 mA, Clamp: On, Slew: Slow     |
| <b>CrossLink Interface</b>     |      |      |               |        |                                       |
| CSI2_sens_clk                  | P27  | 2    | LVC MOS33_IN  | PR44C  | Pull: Down, Clamp: On, Hysteresis: On |
| CSI2_sens_fv                   | K27  | 2    | LVC MOS33_IN  | PR38A  | Pull: Down, Clamp: On, Hysteresis: On |
| CSI2_sens_lv                   | K26  | 2    | LVC MOS33_IN  | PR38B  | Pull: Down, Clamp: On, Hysteresis: On |
| CSI2_sens_data[0]              | A13  | 0    | LVC MOS33_IN  | PT42B  | Pull: Down, Clamp: On, Hysteresis: On |
| CSI2_sens_data[1]              | A8   | 0    | LVC MOS33_IN  | PT20B  | Pull: Down, Clamp: On, Hysteresis: On |
| CSI2_sens_data[2]              | F9   | 0    | LVC MOS33_IN  | PT22A  | Pull: Down, Clamp: On, Hysteresis: On |
| CSI2_sens_data[3]              | D9   | 0    | LVC MOS33_IN  | PT22B  | Pull: Down, Clamp: On, Hysteresis: On |
| CSI2_sens_data[4]              | C9   | 0    | LVC MOS33_IN  | PT24A  | Pull: Down, Clamp: On, Hysteresis: On |
| CSI2_sens_data[5]              | A9   | 0    | LVC MOS33_IN  | PT24B  | Pull: Down, Clamp: On, Hysteresis: On |
| CSI2_sens_data[6]              | C10  | 0    | LVC MOS33_IN  | PT29B  | Pull: Down, Clamp: On, Hysteresis: On |
| CSI2_sens_data[7]              | B10  | 0    | LVC MOS33_IN  | PT31A  | Pull: Down, Clamp: On, Hysteresis: On |
| CSI2_sens_data[8]              | A10  | 0    | LVC MOS33_IN  | PT31B  | Pull: Down, Clamp: On, Hysteresis: On |
| CSI2_sens_data[9]              | E11  | 0    | LVC MOS33_IN  | PT33B  | Pull: Down, Clamp: On, Hysteresis: On |
| reset_crosslink                | D13  | 0    | LVC MOS33_OUT | PT40B  | Drive:8 mA, Clamp: On, Slew: Slow     |
| <b>Camera Sensor Interface</b> |      |      |               |        |                                       |
| scl                            | D15  | 0    | LVC MOS33_OUT | PT51B  | Drive:8 mA, Clamp: On, Slew: Slow     |
| scl2                           | A14  | 0    | LVC MOS33_OUT | PT49B  | Drive:8 mA, Clamp: On, Slew: Slow     |
| sda                            | F15  | 0    | LVC MOS33_OUT | PT51A  | Drive:8 mA, Clamp: On, Slew: Slow     |
| sda2                           | B14  | 0    | LVC MOS33_OUT | PT49A  | Drive:8 mA, Clamp: On, Slew: Slow     |
| reset_sensor                   | B4   | 0    | LVC MOS33_OUT | PT4B   | Drive:8 mA, Clamp: On, Slew: Slow     |
| <b>SiI1136 Interface</b>       |      |      |               |        |                                       |
| HDMI_scl                       | AG1  | 8    | LVC MOS33_OUT | PB4A   | Drive:8 mA, Clamp: On, Slew: Slow     |
| HDMI_sda                       | AJ1  | 8    | LVC MOS33_OUT | PB6A   | Drive:8 mA, Clamp: On, Slew: Slow     |
| pixclk_out                     | E25  | 1    | LVC MOS33_OUT | PT110A | Drive:8 mA, Clamp: On, Slew: Slow     |
| data_enable                    | C25  | 1    | LVC MOS33_OUT | PT107A | Drive:8 mA, Clamp: On, Slew: Slow     |
| hsync                          | D25  | 1    | LVC MOS33_OUT | PT107B | Drive:8 mA, Clamp: On, Slew: Slow     |
| vsync                          | A25  | 1    | LVC MOS33_OUT | PT105A | Drive:8 mA, Clamp: On, Slew: Slow     |
| pix_blue[0]                    | T31  | 3    | LVC MOS33_OUT | PR65B  | Drive:8 mA, Clamp: On, Slew: Slow     |
| pix_blue[1]                    | R32  | 3    | LVC MOS33_OUT | PR65A  | Drive:8 mA, Clamp: On, Slew: Slow     |
| pix_blue[2]                    | Y32  | 3    | LVC MOS33_OUT | PR86B  | Drive:8 mA, Clamp: On, Slew: Slow     |
| pix_blue[3]                    | W31  | 3    | LVC MOS33_OUT | PR86A  | Drive:8 mA, Clamp: On, Slew: Slow     |
| pix_blue[4]                    | T29  | 3    | LVC MOS33_OUT | PR53C  | Drive:8 mA, Clamp: On, Slew: Slow     |
| pix_blue[5]                    | U28  | 3    | LVC MOS33_OUT | PR53D  | Drive:8 mA, Clamp: On, Slew: Slow     |
| pix_blue[6]                    | V27  | 3    | LVC MOS33_OUT | PR56C  | Drive:8 mA, Clamp: On, Slew: Slow     |
| pix_blue[7]                    | V26  | 3    | LVC MOS33_OUT | PR56D  | Drive:8 mA, Clamp: On, Slew: Slow     |
| pix_blue[8]                    | AC31 | 3    | LVC MOS33_OUT | PR89C  | Drive:8 mA, Clamp: On, Slew: Slow     |
| pix_blue[9]                    | AB32 | 3    | LVC MOS33_OUT | PR92A  | Drive:8 mA, Clamp: On, Slew: Slow     |

## 8. Ordering Information

**Table 8.1. Ordering Information**

| Description                             | Ordering Part Number |
|---|----------------------|
| Lattice Embedded Vision Development Kit | LF-EVDK1-EVN         |

## References

For more information, refer to:

- [ECP5 and ECP5-5G Family Data Sheet \(FPGA-DS-02012, previously DS1044\)](#)
- [CrossLink Family Data Sheet \(FPGA-DS-02007\)](#)
- [SiI9136-3/SiI1136 HDMI Deep Color Transmitter \(SiI-DS-1084\)](#)

For schematics, refer to:

- [ECP5 VIP Processor Board Evaluation Board User Guide \(FPGA-EB-02001\)](#)
- [CrossLink VIP Input Bridge Board Evaluation Board User Guide \(FPGA-EB-02002\)](#)
- [HDMI VIP Output Bridge Board Evaluation Board User Guide \(FPGA-EB-02003\)](#)

## Technical Support

For assistance, submit a technical support case at [www.latticesemi.com/techsupport](http://www.latticesemi.com/techsupport).

## Appendix A. Lattice Embedded Vision Development Kit Setup

To set up the display demo boards:

1. Connect the J3 and J1 connectors of the CrossLink VIP input bridge board to the J10 and J11 connectors of the ECP5 VIP board.
2. Connect the J13 and J12 connectors of the ECP5 VIP board to the J2 and J1 connectors of the HDMI VIP output board.
3. Connect one end of the HDMI cable to the C1 connector of the HDMI VIP output board and the other end to the monitor.
4. Connect the 12 V wall power adapter cable to the J4 connector of the ECP5 VIP board.
5. The Dual CSI-2 camera to HDMI Bridge design should be programmed into the SPI Flash on the EVDK. This loads the reference design on power up. Refer to [Appendix B. Programming the Lattice Embedded Vision Development Kit](#) to update or change the FPGA or SPI Flash images.

## Appendix B. Programming the Lattice Embedded Vision Development Kit

### Using Diamond Programmer with the EVDK

The EVDK has a built-in download controller for programming. It uses an FT2232H Future Technology Devices International (FTDI) part to convert USB to JTAG. To use the built-in download controller, connect the USB cable from J2 of the ECP5 VIP Processor Board to your PC (with Diamond programming software installed). A mini USB to USB-A cable is included in the EVDK. The USB hub on the PC detects the cable of the USB function on Port 0, making the built-in download controller available for use with the Diamond programming software.

In order to provide a single programming interface for the EVDK, the ECP5 VIP Processor Board's JTAG interface is shared with the CrossLink VIP Input Bridge Board's SPI programming interface. During a JTAG scan, the Diamond Programmer only sees one of the devices:

- LFE5UM-85F, if the CrossLink device is currently programmed
- LIF-MD6000, if the CrossLink device is not programmed

A JTAG scan also erases both ECP5 and CrossLink SRAM images, requiring you to reprogram both devices. When using the Diamond Programmer, selecting **Create a new blank project** and manually selecting the device family and device prevents the erasure of both devices.

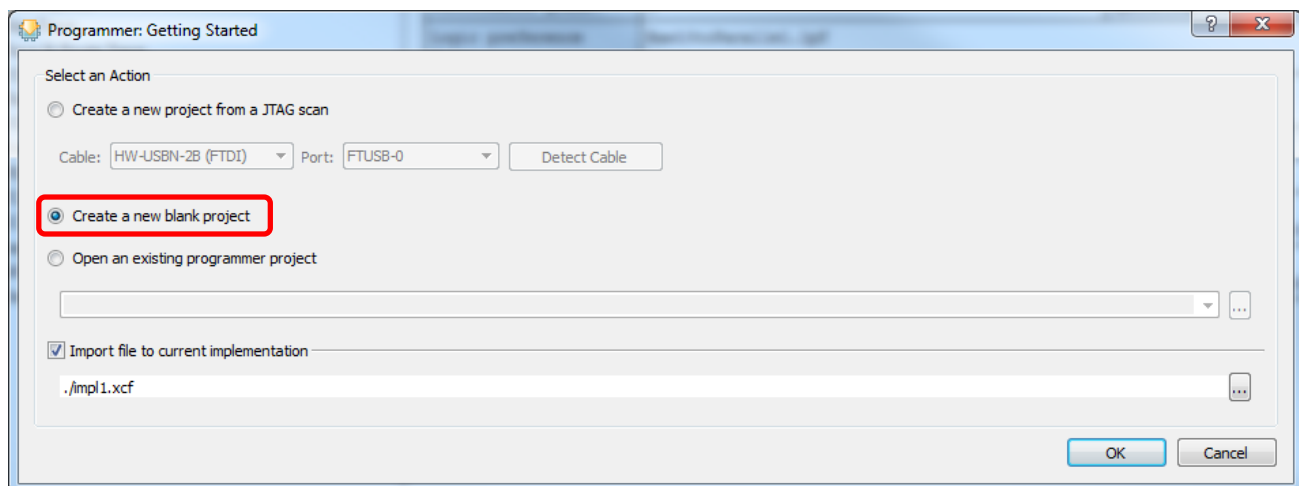

Figure B.1. Create a New Blank Project

### ECP5 SPI Flash Programming

#### Erasing the ECP5 Prior to Reprogramming

If the ECP5 is already programmed (either directly, or loaded from SPI Flash), erase first the ECP5 SRAM memory, then program the ECP5's SPI Flash in the next section. Keep the board powered when re-programming the SPI Flash in the next section.

To erase the ECP5:

1. Launch Diamond Programmer with **Create a new blank project**.
2. Select **ECP5UM** for **Device Family** and **LFE5UM-85F** for **Device**.

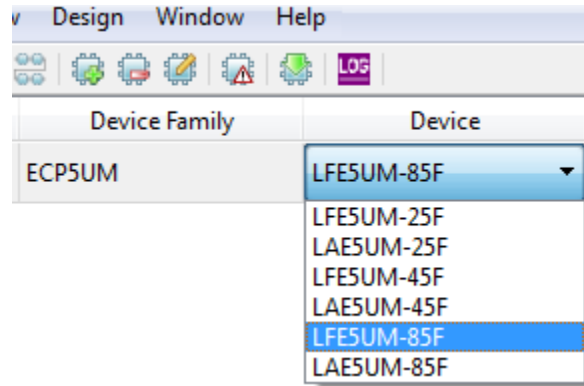

Figure B.2. Selecting Device

3. Right-click and select **Device Properties**.
4. Select **JTAG 1532 Mode** for **Access Mode** and **Erase Only** for **Operation**.

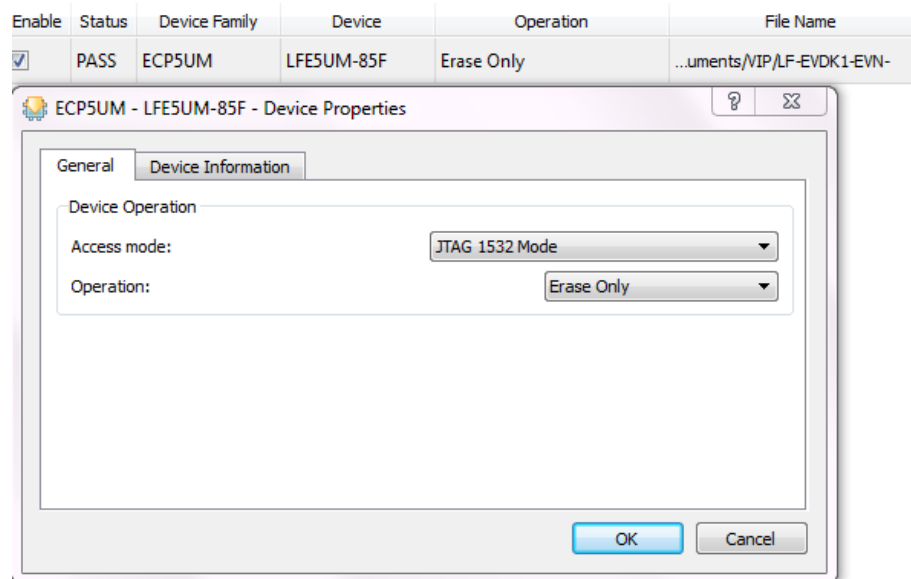



Figure B.3. Device Operation

5. Click **OK** to close the Device Properties window.
6. Click the **Program** button  in Diamond Programmer to start the Erase sequence.

## Programming the SPI on the ECP5 VIP Processor Board

To program the SPI:

1. Ensure the ECP5 device is erased by performing Steps 1-6.
2. Right-click and select **Device Properties**.
3. Select **SPI Flash Background Programming** for **Access mode** and make the following selections:
  - a. For **Programming File**, browse and select the **ECP5 bitfile (\*.bit)**
  - b. For **SPI Flash Options**, refer [Table B.1](#).

**Table B.1. SPI Flash Options Selection Guide**

| Item    | Rev A/B          | Rev C   |
|---------|------------------|---|
| Family  | SPI Serial Flash | SPI Serial Flash  |
| Vendor  | Micron           | Macronix  |
| Device  | SPI-N25Q128A     | MX25L12835F   |
| Comment | —                | If the above device is not available in Diamond Programmer, select Macronix MX25L12805. |

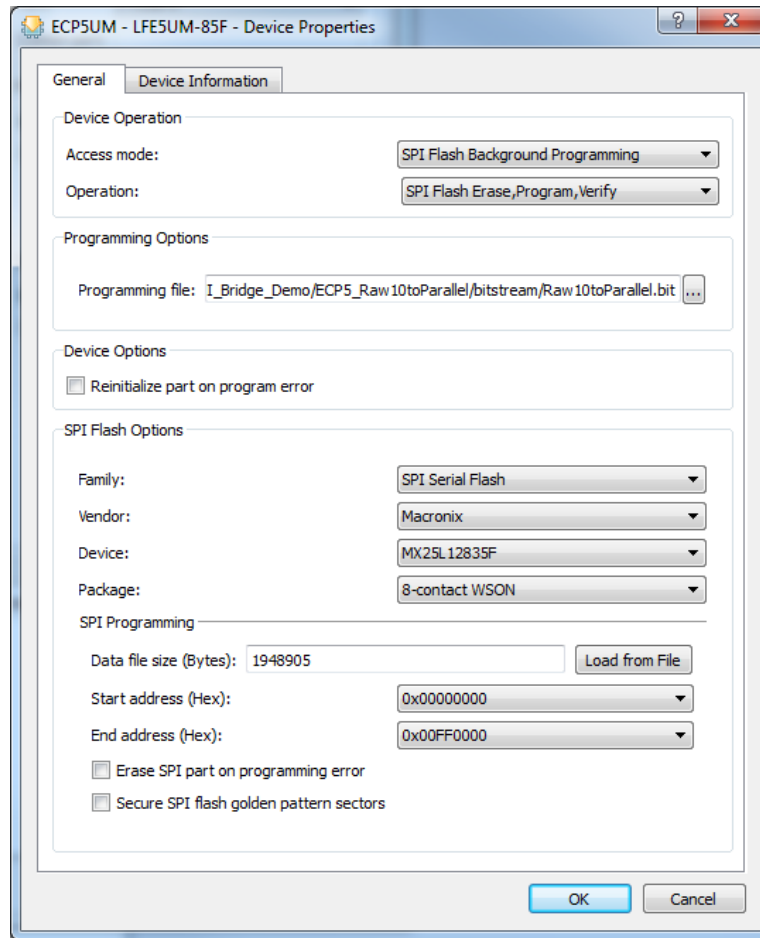

**Figure B.4. Device Properties**

4. Click **OK** to close the **Device Properties** window.
5. Click the **Program** button  in Diamond Programmer to start the programming sequence.
6. After successful programming, the **Output** console displays the results as shown in [Figure B.5](#)



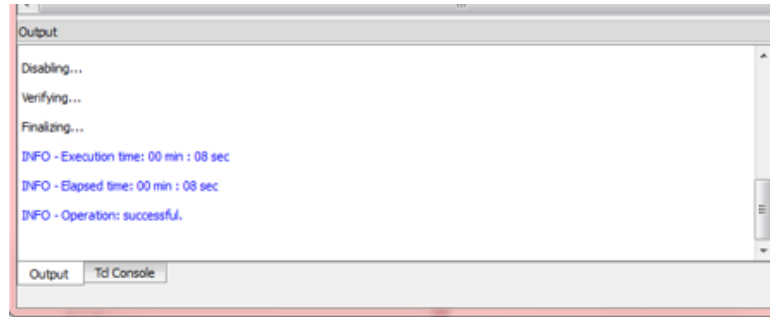

**Figure B.5. Output Console**

## CrossLink SPI Flash Programming

### Erasing the CrossLink FPGA Prior to Reprogramming

If the CrossLink device is already programmed (either directly, or loaded from SPI Flash), follow this procedure to first erase the CrossLink SRAM memory before re-programming the CrossLink’s SPI Flash. If you are doing this, keep the board powered when re-programming the SPI Flash (so it does not reload on reboot).

To erase CrossLink:

1. Launch Diamond Programmer with **Create a new blank project**.
2. Select **LIFMD** for **Device Family** and **LIF-MD6000** for **Device**.

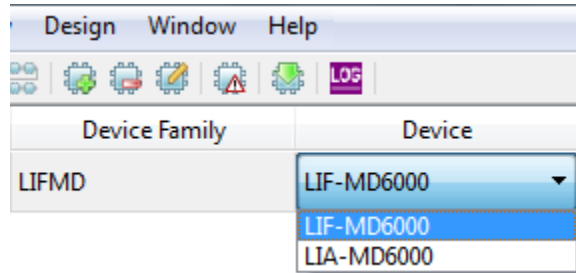

Figure B.6. Select Device

3. Right-click and select **Device Properties**.
4. Select SSPI SRAM Programming for Access Mode and Erase Only for Operation.

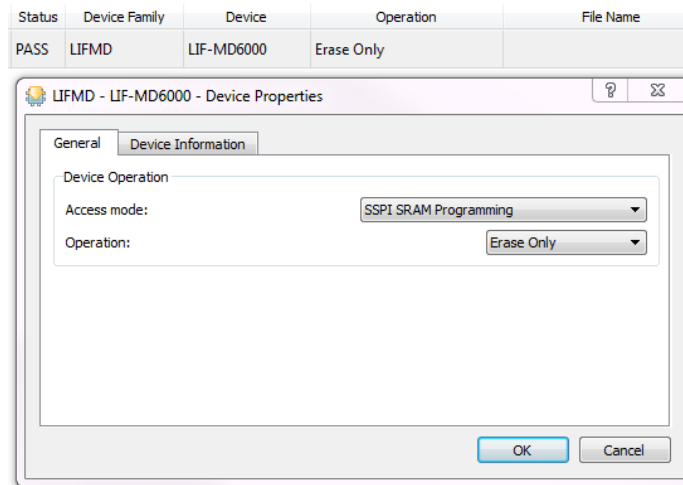



Figure B.7. Device Operation

5. Click **OK** to close the Device Properties window.
6. Click the **Program** button  in Diamond Programmer to start the Erase sequence.

## Programming the SPI on the CrossLink VIP Input Bridge Board

To program the SPI:

1. Ensure the CrossLink device is erased by performing Steps 1-6.
2. Right-click and select **Device Properties**.
3. Select **SPI Flash Programming** for **Access mode** and make the following selections:
  - a. For **Programming File**, browse and select the **CrossLink bitfile (\*.bit)**.
  - b. For **SPI Flash Options**, refer to [Table B.2](#).

**Table B.2. SPI Flash Options Selection Guide**

| Item    | Rev A/B                   | Rev C – Option 1        | Rev C – Option 2          | Rev C – Option 3   |
|---------|---------------------------|-------------------------|---------------------------|--|
| Family  | SPI Serial Flash          | SPI Serial Flash        | SPI Serial Flash          | SPI Serial Flash   |
| Vendor  | Micron / ST Micro         | Micron                  | Micron / ST Micro         | Numonyx / Micron   |
| Device  | SPI-M25PX16               | MT25QL128               | SPI-M25PX16               | M25P128  |
| Comment | Marked with ST-Micro Logo | Marked with Micron Logo | Marked with ST-Micro Logo | Marked with Lot Code Only – No Vendor or Part Number Marking |

**Note:** Boards are populated with one of any qualified SPI Flash Device (U9). This device is located just below the Lattice logo on the top of the board. It is best to verify this device visually by the marking on the device. Use this table to determine the correct selection in Diamond Programmer.

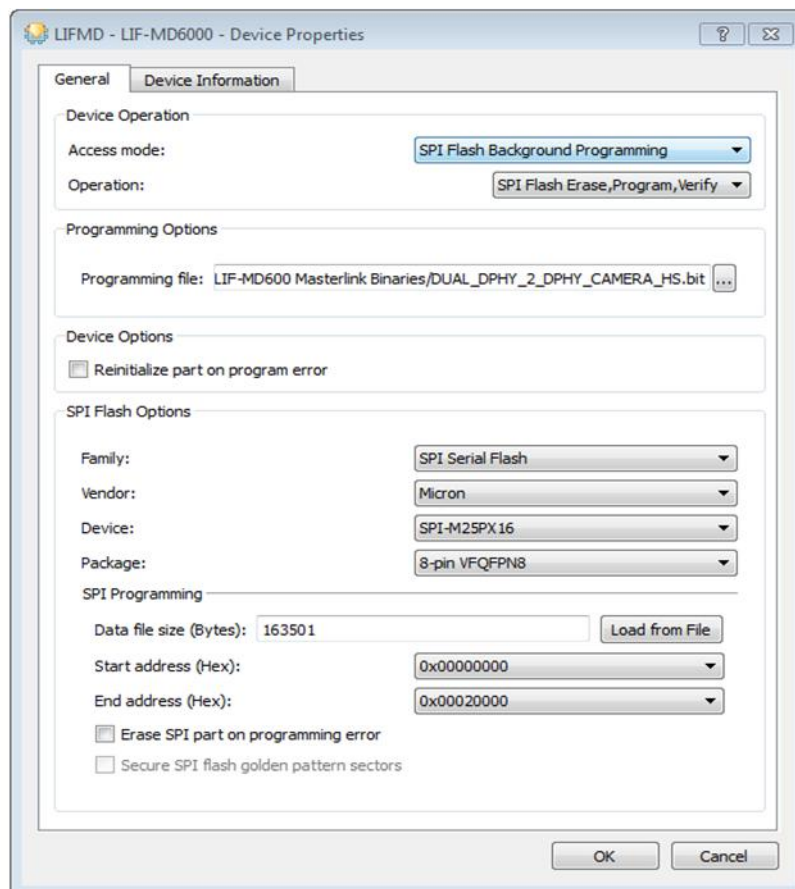

**Figure B.8. Device Properties**

4. Click **OK** to close the **Device Properties** window.
5. Click the **Program** button  in Diamond Programmer to start the programming sequence.
6. After successful programming, the **Output** console displays the results as shown in [Figure B.9](#).

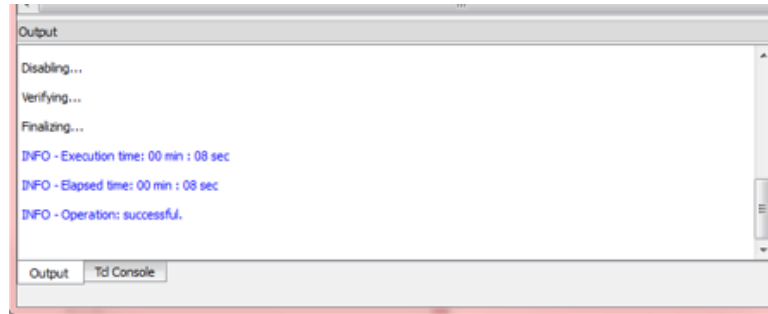

Figure B.9. Output Console

## Troubleshooting CrossLink VIP Input Bridge Board Programming

To troubleshoot CrossLink (LIF-MD6000) programming:

1. Make sure the CrossLink device is erased prior to programming SPI flash. If you re-power the board, it will reload the SPI Flash image to the CrossLink. Follow the sequence in the Crosslink SPI Flash Programming section of this document. Erase CrossLink (LIF-MD6000) first, and then perform the SPI Flash programming sequence without re-powering the board.
2. R47 is a pull-up resistor on the SPI SCK line. This was originally specified as 1 k $\Omega$ . Later testing suggests 10 k $\Omega$  improves noise immunity for SPI Programming. If possible, changing this resistor to 10 k $\Omega$  may improve SPI programming consistency. Boards populated with R47 = 10 k $\Omega$  have a small dot in the silkscreen box, just above the copyright mark.
3. For short-term workaround of SPI Flash programming issues, you can use SSPI SRAM Programming (programming CrossLink SRAM directly). This programming will only be retained as long as power remains applied to the board, and the device is not reset.

## Revision History

### Revision 1.3, November 2018

| Section   | Change Summary   |
|---|--|
| Appendix B. Programming the Lattice Embedded Vision Development Kit | <ul style="list-style-type: none"> <li>Changed value of device in Revision C under <a href="#">Table B.1. SPI Flash Options Selection Guide</a>.</li> <li>Updated <a href="#">Figure B.4. Device Properties</a>.</li> <li>Updated <a href="#">Table B.1. SPI Flash Options Selection Guide</a>.</li> <li>Updated <a href="#">Table B.2. SPI Flash Options Selection Guide</a>.</li> <li>Added <a href="#">Troubleshooting CrossLink VIP Input Bridge Board Programming</a> section.</li> </ul> |
| Revision History  | Updated revision history table to new template.  |

### Revision 1.2, February 2018

| Section   | Change Summary                        |
|---|---------------------------------------|
| Introduction  | Updated figures for Rev C board.      |
| Functional Description  | Updated ECP5 section for ECP5 Design. |
| Demo Package Directory Structure                                    | General update.                       |
| Appendix B. Programming the Lattice Embedded Vision Development Kit | Added this section in the document.   |

### Revision 1.1, January 2018

| Section   | Change Summary  |
|---|---|
| All   | Updated Lattice Semiconductor Logo on the cover pages, headers, and footers of this document. |
| Introduction  | Changed pASSP to FPGA.  |
| Appendix A. Lattice Embedded Vision Development Kit Setup | Changed pASSP to FPGA.  |

### Revision 1.0, April 2017

| Section | Change Summary   |
|---------|------------------|
| All     | Initial release. |



7<sup>th</sup> Floor, 111 SW 5<sup>th</sup> Avenue  
Portland, OR 97204, USA  
T 503.268.8000  
[www.latticesemi.com](http://www.latticesemi.com)

## Данный компонент на территории Российской Федерации

### Вы можете приобрести в компании MosChip.

Для оперативного оформления запроса Вам необходимо перейти по данной ссылке:

<http://moschip.ru/get-element>

Вы можете разместить у нас заказ для любого Вашего проекта, будь то серийное производство или разработка единичного прибора.

В нашем ассортименте представлены ведущие мировые производители активных и пассивных электронных компонентов.

Нашей специализацией является поставка электронной компонентной базы двойного назначения, продукции таких производителей как XILINX, Intel (ex.ALTERA), Vicor, Microchip, Texas Instruments, Analog Devices, Mini-Circuits, Amphenol, Glenair.

Сотрудничество с глобальными дистрибьюторами электронных компонентов, предоставляет возможность заказывать и получать с международных складов практически любой перечень компонентов в оптимальные для Вас сроки.

На всех этапах разработки и производства наши партнеры могут получить квалифицированную поддержку опытных инженеров.

Система менеджмента качества компании отвечает требованиям в соответствии с ГОСТ Р ИСО 9001, ГОСТ РВ 0015-002 и ЭС РД 009

### Офис по работе с юридическими лицами:

105318, г.Москва, ул.Щербаковская д.3, офис 1107, 1118, ДЦ «Щербаковский»

Телефон: +7 495 668-12-70 (многоканальный)

Факс: +7 495 668-12-70 (доб.304)

E-mail: [info@moschip.ru](mailto:info@moschip.ru)

Skype отдела продаж:

moschip.ru

moschip.ru\_4

moschip.ru\_6

moschip.ru\_9