

RM84 / RM85 / RM87

Miniature Electromagnetic Relays



- Miniature dimensions
- 5000 V / 10 mm reinforced insulation
- Available special versions with the increased dielectric strength of the contact clearance
- IP67 flux proof, water proof and sealed cover protection (For IP40 unsealed, contact Altech)
- Cadmium - free contacts
- For PCB and plug-in sockets

Contact Data		RM84	RM85	RM87
No. and type of contacts		DPDT, DPST (2N0)	SPDT, SPST (1N0)	SPDT, SPST (1N0)
Contact material		AgNi	AgNi	AgNi
Rated / max. switching voltage	AC	250 V / 440 V	250 V / 440 V	250 V / 440 V
Min. switching voltage		5 V	5 V	5 V
Rated load (capacity)		8 A / 250 V AC	16 A / 250 V AC	12 A / 250 V AC
	AC15	3 A / 120 V; 1.5 A / 240 V (B300)	3 A / 120 V; 1.5 A / 240 V (B300)	3 A / 120 V; 1.5 A / 240 V (B300)
	AC3	550 W (single-phase motor)	750 W (single-phase motor)	750 W (single-phase motor)
	DC1	8 A / 24 V DC (see Fig. 3.1)	16 A / 24 V DC (see Fig. 3.2)	12 A / 24 V DC (see Fig. 3.3)
	DC13	0.22 A / 120 V; 0.1 A / 250 V (R300)	0.22 A / 120 V; 0.1 A / 250 V (R300)	0.22 A / 120 V; 0.1 A / 250 V (R300)
Min. switching current		5 mA	5 mA	5 mA
Max. inrush current		12 A	24 A	18 A
Rated current		8 A	16 A	12 A
Max. breaking capacity	AC1	2 000 VA	4 000 VA	3 000 VA
Min. breaking capacity		0.3 W	0.3 W	0.3 W
Contact resistance		≤ 100 mΩ	≤ 100 mΩ	≤ 100 mΩ
Max. operating frequency		600 cycles/hour	600 cycles/hour	600 cycles/hour
	• at rated load	72000 cycles/hour	72000 cycles/hour	72000 cycles/hour
	• no load			
Coil Data				
Rated voltage	50/60 Hz AC	12 ... 240 V	12 ... 240 V	12 ... 240 V
	DC	3 ... 110 V	3 ... 110 V	3 ... 110 V
Must release voltage		AC: ≥ 0.15 U _N ; DC: ≥ 0.1 U _N	AC: ≥ 0.15 U _N ; DC: ≥ 0.1 U _N	AC: ≥ 0.15 U _N ; DC: ≥ 0.1 U _N
Operating range of supply voltage		see page 80 and Fig. 4.1. 5.1	see page 80 and Fig. 4.2. 5.2	see page 80 and Fig. 4.3. 5.3
Rated power consumption	AC	0.75 VA	0.75 VA	0.75 VA
	DC	0.4 ... 0.48 W	0.4 ... 0.48 W	0.4 ... 0.48 W
Insulation				
Insulation rated voltage		400 V AC	400 V AC	400 V AC
Rated surge voltage		4000 V 1.2 / 50 μs	4000 V 1.2 / 50 μs	4000 V 1.2 / 50 μs
Overvoltage category		III	III	III
Insulation pollution degree		3	3	3
Dielectric strength		5000 V AC type of insulation: reinforced	5000 V AC type of insulation: reinforced	5000 V AC type of insulation: reinforced
	• between coil and contacts	1000 V AC type of clearance: micro-disconnection	1000 V AC type of clearance: micro-disconnection	1000 V AC type of clearance: micro-disconnection
	• contact clearance	2000 V AC contacts DPST (2N0). type of clearance: full-disconnect	2000 V AC contacts DPST (2N0). type of clearance: full-disconnect	2000 V AC contacts SPST (1N0). type of clearance: full-disconnect
	• pole - pole	2500 V AC type of insulation: basic	-	-
Contact - coil distance		≥ 10 mm	≥ 10 mm	≥ 10 mm
	• clearance	≥ 10 mm	≥ 10 mm	≥ 10 mm
	• creepage			
General data				
Operating / release time (typical values)		7 ms / 3 ms	7 ms / 3 ms	7 ms / 3 ms
Electrical life				
	• resistive	> 10 ⁶ ; 8 A. 250 V AC	> 0.7 x 10 ⁶ ; 16 A. 250 V AC	> 10 ⁶ ; 12 A. 250 V AC
	• cosφ	see Fig. 2.1	see Fig. 2.2	see Fig. 2.3
	• DC L/R=40 ms	> 10 ⁶ ; 0.15 A. 220 V DC	> 10 ⁶ ; 0.15 A. 220 V DC	> 10 ⁶ ; 0.15 A. 220 V DC
Mechanical life (cycles)		> 3 x 10 ⁷	> 3 x 10 ⁷	> 3 x 10 ⁷
Dimensions (L x W x H)		29 x 12.7 x 15.7 mm	29 x 12.7 x 15.7 mm	29 x 12.7 x 15.7 mm
Weight		14 g	14 g	14 g
Ambient temperature				
	• storage	-40...+85 °C	40...+85 °C	40...+85 °C
	• operating	AC: -40...+70 °C DC: -40...+85 °C	AC: -40...+70 °C DC: -40...+85 °C	AC: -40...+70 °C DC: -40...+85 °C
Cover protection category		IP 67 PN-EN 60529	IP 67 PN-EN 60529	IP 67 PN-EN 60529
Environmental protection		RTIII PN-EN 116000-3	RTIII PN-EN 116000-3	RTIII PN-EN 116000-3
Shock resistance (NO/NC)		20 g	30 g	30 g
Vibration resistance		10 g / 5 g 10...150 Hz	10 g 10...150 Hz	10 g 10...150 Hz
Solder bath temperature		max. 270 °C	max. 270 °C	max. 270 °C
Soldering time		max. 5 s	max. 5 s	max. 5 s

RM84 / RM85 / RM87

Miniature Electromagnetic Relays



RM84



CONNECTION DIAGRAM



Terminal (pin)	A1(1); A2(2)	22(3); 21(4); 24(5); 12(6); 11(7); 14(8)
[mm]	∅ 0.6	0.5 x 0.9
Drilling hole:		
• for relays	∅ 1.3 + 0.1 mm	
• for sockets	∅ 1.5 + 0.1 mm	

DIMENSIONS



LOAD CHARTS

Electrical life at AC resistive load. Switching frequency: 600 cycles/hour **Fig. 1.1**



Electrical life reduction factor at AC inductive load **Fig. 2.1**



Max. DC resistive load breaking capacity **Fig. 3.1**



Coil operating range - DC **Fig. 4.1**



Coil operating range - AC 50 Hz **Fig. 5.1**



Description of Fig. 4.1 and 5.1

A - relations between make voltage and ambient temperature at no load on contacts. Coil temperature and ambient temperature are equal before coil energizing. Make voltage is not higher than the value read on Y axis (multiplication of rated voltage).
B - relations between make voltage and ambient temperature after initial coil heating up with 1.1 U_n at continues load of I_n on contacts. Make voltage is not higher than the value read on Y axis (multiplication of rated voltage).
1, 2, 3 - values on Y axis represent allowed overvoltage on coil at certain ambient temperature and contact load:
1 - no load
2 - 50% of rated load
3 - rated load

RM84 / RM85 / RM87

Miniature Electromagnetic Relays



RM85



CONNECTION DIAGRAM



Terminal (pin)	A1(1); A2(2)	22(3); 21(4); 24(5); 12(6); 11(7); 14(8)
[mm]	∅ 0.6	0.5 x 0.9
Drilling hole:		
• for relays	∅ 1.3 + 0.1 mm	
• for sockets	∅ 1.5 + 0.1 mm	

RM85 terminals are doubled for each contact.
Both terminals are to be used while connecting to load.

DIMENSIONS



LOAD CHARTS

Electrical life at AC resistive load.
Switching frequency: 600 cycles/hour Fig. 1.2

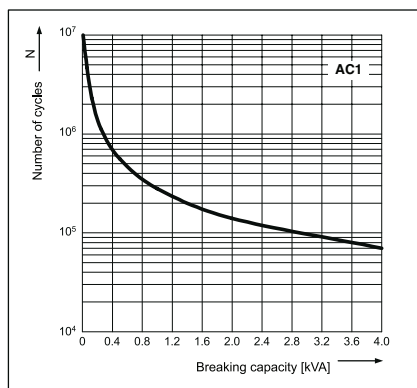

Electrical life reduction factor at AC inductive load Fig. 2.2

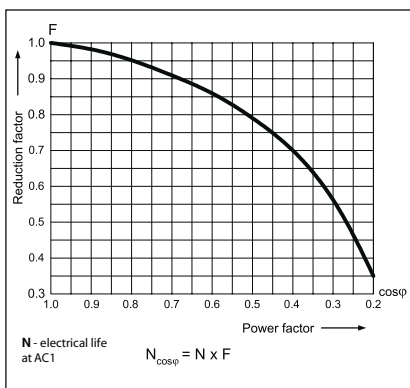

Max. DC resistive load breaking capacity Fig. 3.2

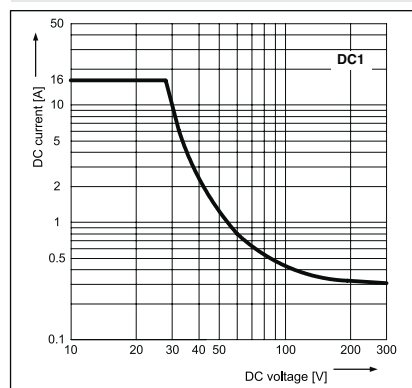

Coil operating range - DC Fig. 4.2

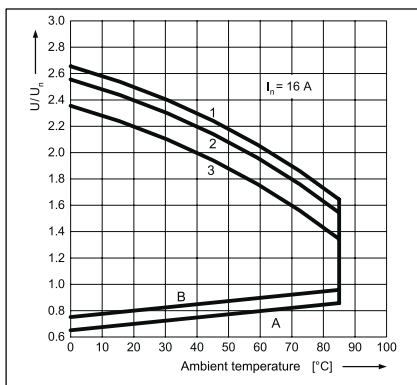

Coil operating range - AC 50 Hz Fig. 5.2

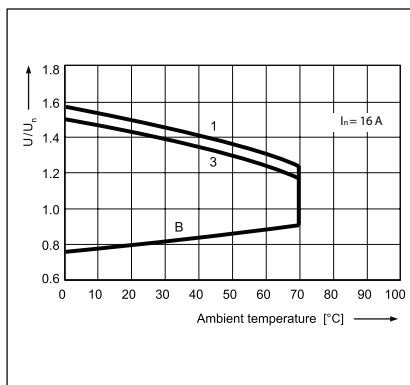

Description of Fig. 4.2 and 5.2

A - relations between make voltage and ambient temperature at no load on contacts. Coil temperature and ambient temperature are equal before coil energizing. Make voltage is not higher than the value read on Y axis (multiplication of rated voltage).
B - relations between make voltage and ambient temperature after initial coil heating up with $1.1 U_n$ at continues load of I_n on contacts. Make voltage is not higher than the value read on Y axis (multiplication of rated voltage).
1, 2, 3 - values on Y axis represent allowed overvoltage on coil at certain ambient temperature and contact load:
1 - no load
2 - 50% of rated load
3 - rated load

RM84 / RM85 / RM87

Miniature Electromagnetic Relays



RM87



CONNECTION DIAGRAM



Terminal (pin)	A1(1); A2(2)	12(3); 11(4); 14(5)
[mm]	Ø 0.6	0.5 x 0.9
Drilling hole:	Ø 1.3 + 0.1 mm	
• for relays	Ø 1.5 + 0.1 mm	
• for sockets		

DIMENSIONS



LOAD CHARTS

Electrical life at AC resistive load. Fig. 1.3
Switching frequency: 600 cycles/hour



Electrical life reduction factor at AC inductive load Fig. 2.3



Max. DC resistive load breaking capacity Fig. 3.3
- standard version

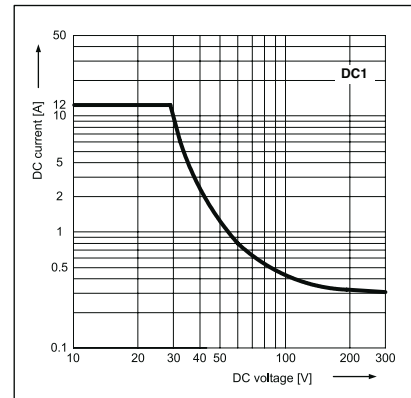

Coil operating range - DC Fig. 4.3
- standard version



Coil operating range - AC 50 Hz Fig. 5.3



Description of Fig. 4.3 and 5.3

A - relations between make voltage and ambient temperature at no load on contacts. Coil temperature and ambient temperature are equal before coil energizing. Make voltage is not higher than the value read on Y axis (multiplication of rated voltage). **B** - relations between make voltage and ambient temperature after initial coil heating up with 1,1 U_n at continues load of I_n on contacts. Make voltage is not higher than the value read on Y axis (multiplication of rated voltage).
1, 2, 3 - values on Y axis represent allowed overvoltage on coil at certain ambient temperature and contact load: 1 - no load; 2 - 50% of rated load; 3 - rated load

RM84 / RM85 / RM87

Miniature Electromagnetic Relays

R84 DPDT AC 50/60Hz & DC coil

Part Number	Coil Voltage (V)	Coil Type	Coil resistance at 20 °C in Ω	Coil operating range	
				min. (at 20°C)	max. (at 55°C)
▶ RM84-2012-35-1012	12	DC	360	8.4	30.6
▶ RM84-2012-35-1024	24	DC	1440	16.8	61.2
▶ RM84-2012-35-1110	110	DC	25200	77.0	280.0
▶ RM84-2012-35-5120	120	AC 50/60Hz	10200	96.0	144.0
▶ RM84-2012-35-5230	230	AC 50/60Hz	38500	184.0	276.0

R84 DPST(2NO) AC 50/60Hz & DC coil

Part Number	Coil Voltage (V)	Coil Type	Coil resistance at 20 °C in Ω	Coil operating range	
				min. (at 20°C)	max. (at 55°C)
▶ RM84-2022-35-1012	12	DC	360	8.4	30.6
▶ RM84-2022-35-1024	24	DC	1440	16.8	61.2
▶ RM84-2022-35-1110	110	DC	25200	77.0	280.0
▶ RM84-2022-35-5120	120	AC 50/60Hz	10200	96.0	144.0
▶ RM84-2022-35-5230	230	AC 50/60Hz	38500	184.0	276.0

R85 SPDT AC 50/60Hz & DC coil

Part Number	Coil Voltage (V)	Coil Type	Coil resistance at 20 °C in Ω	Coil operating range	
				min. (at 20°C)	max. (at 55°C)
▶ RM85-2011-35-1012	12	DC	360	8.4	30.6
▶ RM85-2011-35-1024	24	DC	1440	16.8	61.2
▶ RM85-2011-35-1110	110	DC	25200	77.0	280.0
▶ RM85-2011-35-5120	120	AC 50/60Hz	10200	96.0	144.0
▶ RM85-2011-35-5230	230	AC 50/60Hz	38500	184.0	276.0

R85 SPST(1NO) AC 50/60Hz & DC coil

Part Number	Coil Voltage (V)	Coil Type	Coil resistance at 20 °C in Ω	Coil operating range	
				min. (at 20°C)	max. (at 55°C)
▶ RM85-2021-35-1012	12	DC	360	8.4	30.6
▶ RM85-2021-35-1024	24	DC	1440	16.8	61.2
▶ RM85-2021-35-1110	110	DC	25200	77.0	280.0
▶ RM85-2021-35-5120	120	AC 50/60Hz	10200	96.0	144.0
▶ RM85-2021-35-5230	230	AC 50/60Hz	38500	184.0	276.0

R87 SPDT AC 50/60Hz & DC coil

Part Number	Coil Voltage (V)	Coil Type	Coil resistance at 20 °C in Ω	Coil operating range	
				min. (at 20°C)	max. (at 55°C)
▶ RM87N-2011-35-1012	12	DC	360	8.4	30.6
▶ RM87N-2011-35-1024	24	DC	1440	16.8	61.2
▶ RM87N-2011-35-1110	110	DC	25200	77.0	280.0
▶ RM87N-2011-35-5120	120	AC 50/60Hz	10200	96.0	144.0
▶ RM87N-2011-35-5230	230	AC 50/60Hz	38500	184.0	276.0

R87 SPST(1NO) AC 50/60Hz & DC coil

Part Number	Coil Voltage (V)	Coil Type	Coil resistance at 20 °C in Ω	Coil operating range	
				min. (at 20°C)	max. (at 55°C)
▶ RM87N-2021-35-1012	12	DC	360	8.4	30.6
▶ RM87N-2021-35-1024	24	DC	1440	16.8	61.2
▶ RM87N-2021-35-1110	110	DC	25200	77.0	280.0
▶ RM87N-2021-35-5120	120	AC 50/60Hz	10200	96.0	144.0
▶ RM87N-2021-35-5230	230	AC 50/60Hz	38500	184.0	276.0

* waterproof version

▶ **BOLD** - Regular stocked items.

RM84 / RM85 / RM87

Miniature Electromagnetic Relays - Plug-in Sockets and Accessories **Altech**[®]

GZT80 (for RM84 / RM85)

Screw terminals
 Max. tightening moment
 for the terminal: 0.7 Nm
 35 mm rail mount
 acc. to PN-EN 60715
 or on panel mounting
 75.3 x 15.5 x 61(67) mm*
 Two poles, 5 mm pinout
 12 A, 300 V AC



E22891



GZT80

CONNECTION DIAGRAM



RM84 RM85

DIMENSIONS



ZGGZ80 (see page 110)



GZT80-0040



GZM80-0041**



GZT80-0035



Module type M... (see page 113)

GZM80 (for RM84 / RM85)

Screw terminals
 Max. tightening moment
 for the terminal: 0.7 Nm
 35 mm rail mount
 acc. to PN-EN 60715
 or on panel mounting
 78.1 x 15.9 x 61(66.5) mm*
 Two poles, 5 mm pinout
 12 A, 300 V AC



E22891



GZM80

CONNECTION DIAGRAM



RM84 RM85

DIMENSIONS



ZGGZ80 (see page 110)



GZT80-0040



GZM80-0041**



GZT80-0035



Module type M... (see page 113)

* In parenthesis is the height of the socket with plastic retainer clip. ** For lower profile application.

All accessories are sold separately.

RM84 / RM85 / RM87

Miniature Electromagnetic Relays - Plug-in Sockets and Accessories

GZT92 (for RM87)

Screw terminals
 Max. tightening moment
 for the terminal: 0.7 Nm
 35 mm rail mount
 acc. to PN-EN 60715
 or on panel mounting
 75.3 x 15.5 x 61(67) mm*
 One pole, 3,5 mm
 12 A, 300 V AC



E22891



GZT92



ZGGZ80 (see page 110)

CONNECTION DIAGRAM



RM87

DIMENSIONS

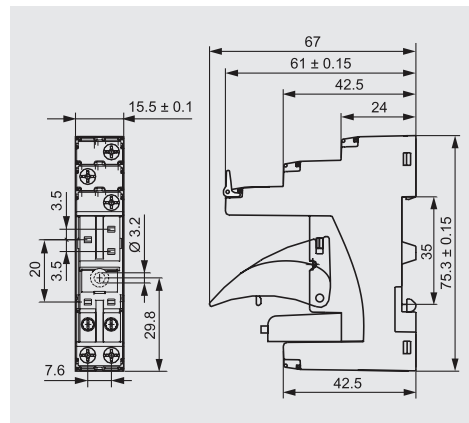

GZT80-0040



GZM80-0041**



GZT80-0035



Module type M... (see page 113)

GZM92 (for RM87)

Screw terminals
 Max. tightening moment
 for the terminal: 0.7 Nm
 35 mm rail mount
 acc. to PN-EN 60715
 or on panel mounting
 78.1 x 15.9 x 61(66.5) mm*
 One pole, 3,5 mm pinout
 12 A, 300 V AC



E22891



GZM92



ZGGZ80 (see page 110)

CONNECTION DIAGRAM

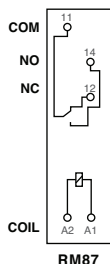

RM87

DIMENSIONS

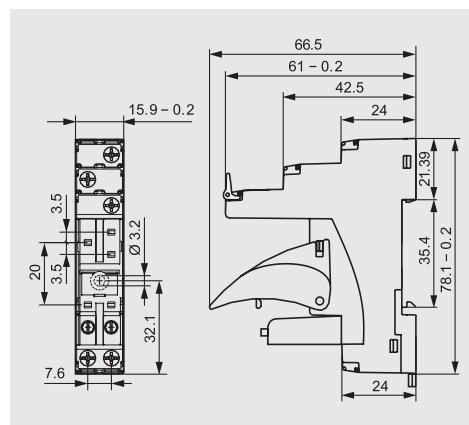

GZT80-0040



GZM80-0041**



GZT80-0035



Module type M... (see page 113)

* In parenthesis is the height of the socket with plastic retainer clip. ** For lower profile application.

All accessories are sold separately.

RM84 / RM85 / RM87

Miniature Electromagnetic Relays - Plug-in Sockets and Accessories

GZMB80 (for RM84, RM85)

Spring terminals
 Max. cross section of the cables:
 1 x 0.2...1.5 mm²
 (1 x 24...16 AWG)
 Stripping length deinsulation:
 9...11 mm
 35 mm rail mount
 acc. to PN-EN 60715
 97 x 16 x 45.2(69) mm*
 Two poles, 5 mm pinout
 10 A, 300 V AC



GZMB80

CONNECTION DIAGRAM



DIMENSIONS



GZMB80-0040



GZMB80-0041**



TR



Module type M... (see page 113)

GD50 (for RM84, RM85)

For RM84, RM85

For PCB
 31.5 x 13 x 9 mm
 Two poles, 5 mm pinout
 8 A, 300 V AC



GD50

CONNECTION DIAGRAM



DIMENSIONS



MH16-2

GD35 (for RM87N)

For RM87

For PCB
 31.5 x 13 x 9 mm
 One pole, 3.5 mm pinout
 12 A, 300 V AC



GD35

CONNECTION DIAGRAM



DIMENSIONS



MH16-2

* In parenthesis is the height of the socket with plastic retainer clip. ** For lower profile application.

All accessories are sold separately.

Данный компонент на территории Российской Федерации

Вы можете приобрести в компании MosChip.

Для оперативного оформления запроса Вам необходимо перейти по данной ссылке:

<http://moschip.ru/get-element>

Вы можете разместить у нас заказ для любого Вашего проекта, будь то серийное производство или разработка единичного прибора.

В нашем ассортименте представлены ведущие мировые производители активных и пассивных электронных компонентов.

Нашей специализацией является поставка электронной компонентной базы двойного назначения, продукции таких производителей как XILINX, Intel (ex.ALTERA), Vicor, Microchip, Texas Instruments, Analog Devices, Mini-Circuits, Amphenol, Glenair.

Сотрудничество с глобальными дистрибьюторами электронных компонентов, предоставляет возможность заказывать и получать с международных складов практически любой перечень компонентов в оптимальные для Вас сроки.

На всех этапах разработки и производства наши партнеры могут получить квалифицированную поддержку опытных инженеров.

Система менеджмента качества компании отвечает требованиям в соответствии с ГОСТ Р ИСО 9001, ГОСТ РВ 0015-002 и ЭС РД 009

Офис по работе с юридическими лицами:

105318, г.Москва, ул.Щербаковская д.3, офис 1107, 1118, ДЦ «Щербаковский»

Телефон: +7 495 668-12-70 (многоканальный)

Факс: +7 495 668-12-70 (доб.304)

E-mail: info@moschip.ru

Skype отдела продаж:

moschip.ru

moschip.ru_4

moschip.ru_6

moschip.ru_9