

ZXMS6005SG
60V N-CHANNEL SELF PROTECTED ENHANCEMENT MODE
INTELLIFET™ MOSFET

SUMMARY

Continuous drain source voltage 60 V

On-state resistance 200 mΩ

Nominal load current ($V_{IN} = 5V$) 2 A

Clamping Energy 480 mJ

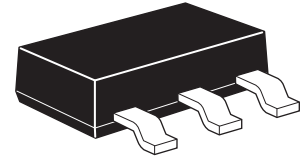

SOT223 Package

DESCRIPTION

The ZXMS6005SG is a self protected low side MOSFET with logic level input. It integrates over-temperature, over-current, over-voltage (active clamp) and ESD protected logic level functionality. The ZXMS6005SG is ideal as a general purpose switch driven from 3.3V or 5V microcontrollers in harsh environments where standard MOSFETs are not rugged enough.

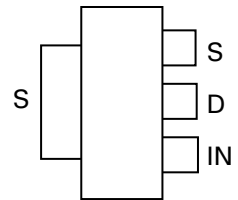

FEATURES

- Compact high power dissipation package
- Low input current
- Logic Level Input (3.3V and 5V)
- Short circuit protection with auto restart
- Over voltage protection (active clamp)
- Thermal shutdown with auto restart
- Over-current protection
- Input Protection (ESD)
- High continuous current rating

ORDERING INFORMATION

| DEVICE | PART MARK | REEL SIZE (inches) | TAPE WIDTH (mm) | QUANTITY PER REEL |
|--------------|------------|--------------------|-----------------|-------------------|
| ZXMS6005SGTA | ZXMS 6005S | 7 | 12 embossed | 1,000 units |

FUNCTIONAL BLOCK DIAGRAM

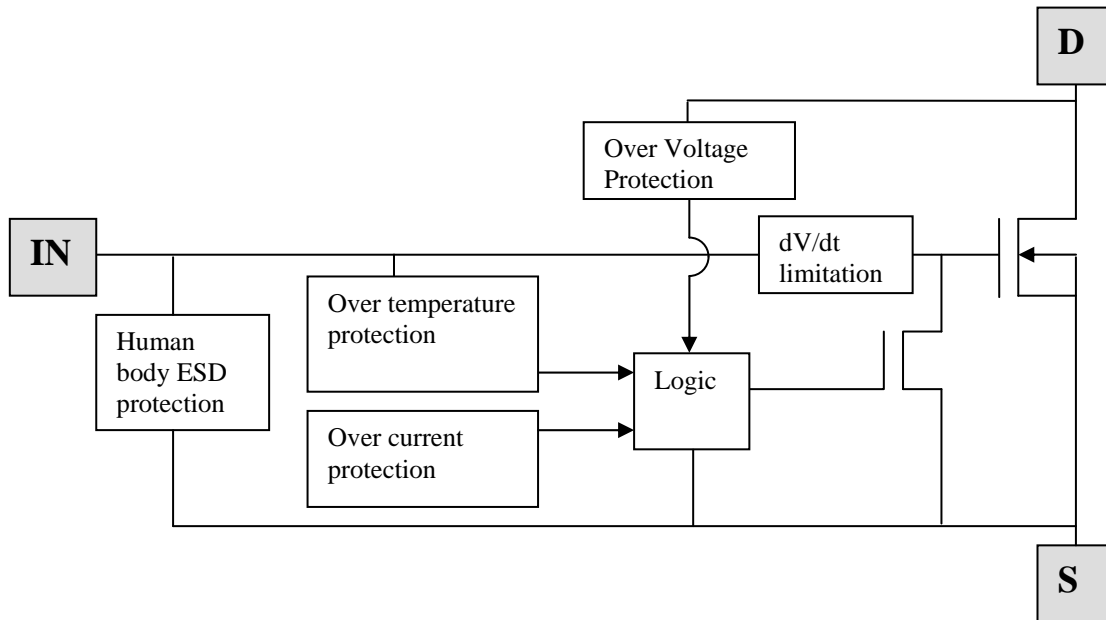

APPLICATIONS AND INFORMATION

- Especially suited for loads with a high in-rush current such as lamps and motors.
- All types of resistive, inductive and capacitive loads in switching applications.
- μC compatible power switch for 12V DC applications.
- Automotive rated.
- Replaces electromechanical relays and discrete circuits.
- Linear Mode capability - the current-limiting protection circuitry is designed to de-activate at low V_{DS} to minimise on state power dissipation. The maximum DC operating current is therefore determined by the thermal capability of the package/board combination, rather than by the protection circuitry. This does not compromise the product's ability to self-protect at low V_{DS} .

ABSOLUTE MAXIMUM RATINGS

| PARAMETER | SYMBOL | LIMIT | UNIT |
|--|--------------|-------------------------------|-------|
| Continuous Drain-Source Voltage | V_{DS} | 60 | V |
| Drain-Source Voltage for short circuit protection | $V_{DS(SC)}$ | 24 | V |
| Continuous Input Voltage | V_{IN} | -0.5 ... +6 | V |
| Continuous Input Current -0.2V ≤ V_{IN} ≤ 6V V_{IN} < -0.2V or V_{IN} > 6V | I_{IN} | No limit $ I_{IN} \leq 2$ | mA |
| Operating Temperature Range | T_j | -40 to +150 | °C |
| Storage Temperature Range | T_{stg} | -55 to +150 | °C |
| Power Dissipation at $T_A = 25^\circ\text{C}$ (a) | P_D | 1.0 | W |
| Linear Derating Factor | | 8.0 | mW/°C |
| Power Dissipation at $T_A = 25^\circ\text{C}$ (b) | P_D | 1.6 | W |
| Linear Derating Factor | | 12.8 | mW/°C |
| Pulsed Drain Current @ $V_{IN} = 3.3\text{V}$ | I_{DM} | 5 | A |
| Pulsed Drain Current @ $V_{IN} = 5\text{V}$ | I_{DM} | 6 | A |
| Continuous Source Current (Body Diode) (a) | I_S | 2.5 | A |
| Pulsed Source Current (Body Diode) | I_{SM} | 10 | A |
| Unclamped single pulse inductive energy, $T_j = 25^\circ\text{C}$, $I_D = 0.5\text{A}$, $V_{DD} = 24\text{V}$ | E_{AS} | 480 | mJ |
| Electrostatic Discharge (Human Body Model) | V_{ESD} | 4000 | V |
| Charged Device Model | V_{CDM} | 1000 | V |

THERMAL RESISTANCE

| PARAMETER | SYMBOL | VALUE | UNIT |
|-------------------------|-----------------|-------|------|
| Junction to Ambient (a) | $R_{\theta JA}$ | 125 | °C/W |
| Junction to Ambient (b) | $R_{\theta JA}$ | 83 | °C/W |
| Junction to Case (c) | $R_{\theta JC}$ | 39 | °C/W |

NOTES

- For a device surface mounted on 15mm x 15mm single sided 1oz weight copper on 1.6mm FR4 board, in still air conditions. Sink split drain 80% and source 20% to isolate connections.
- For a device surface mounted on 50mm x 50mm single sided 2oz weight copper on 1.6mm FR4 board, in still air conditions. Sink split drain 80% and source 20% to isolate connections.
- Thermal resistance between junction and the mounting surfaces of drain and source pins.

RECOMMENDED OPERATING CONDITIONS

The ZXMS6005SG is optimised for use with μC operating from 3.3V and 5V supplies.

| Symbol | Description | Min | Max | Units |
|----------|---|-----|-----|--------------------|
| V_{IN} | Input voltage range | 0 | 5.5 | V |
| T_A | Ambient temperature range | -40 | 125 | $^{\circ}\text{C}$ |
| V_{IH} | High level input voltage for MOSFET to be on | 3 | 5.5 | V |
| V_{IL} | Low level input voltage for MOSFET to be off | 0 | 0.7 | V |
| V_P | Peripheral supply voltage (voltage to which load is referred) | 0 | 24 | V |

CHARACTERISTICS

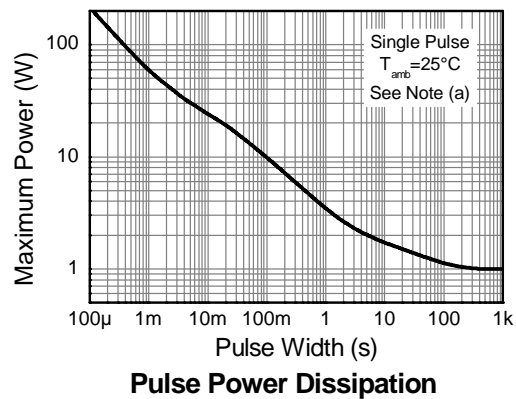
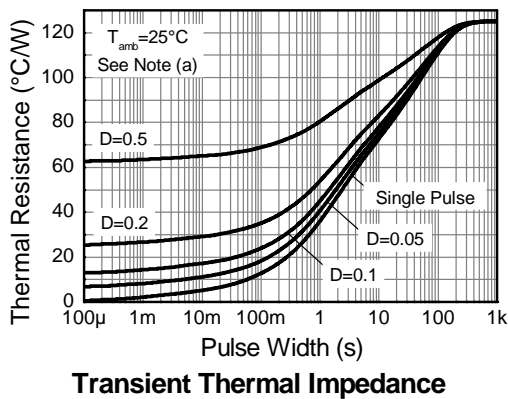
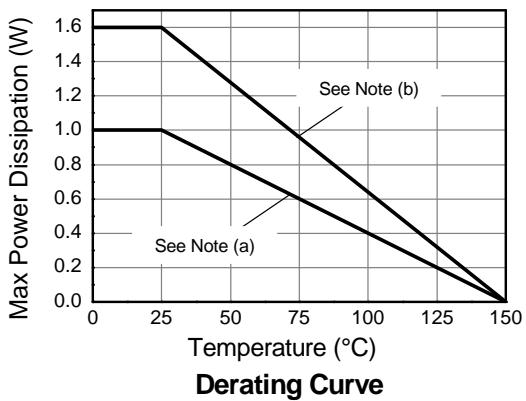
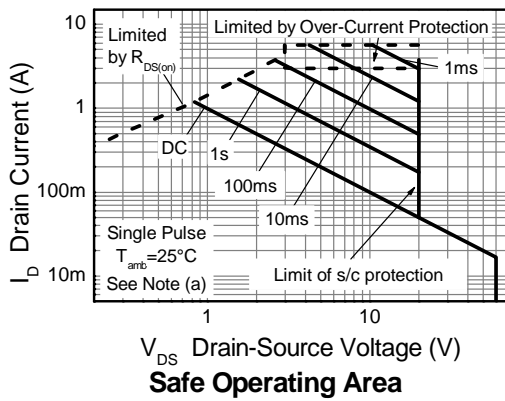

ELECTRICAL CHARACTERISTICS (at $T_{amb} = 25^{\circ}\text{C}$ unless otherwise stated).

| PARAMETER | SYMBOL | MIN | TYP | MAX | UNIT | CONDITIONS |
|---|--------------|-----|-----|-----|------------------|--|
| Static Characteristics | | | | | | |
| Drain-Source Clamp Voltage | $V_{DS(AZ)}$ | 60 | 65 | 70 | V | $I_D=10\text{mA}$ |
| Off state Drain Current | I_{DSS} | | | 1 | μA | $V_{DS}=12\text{V}, V_{IN}=0\text{V}$ |
| Off state Drain Current | I_{DSS} | | | 2 | μA | $V_{DS}=36\text{V}, V_{IN}=0\text{V}$ |
| Input Threshold Voltage | $V_{IN(th)}$ | 0.7 | 1 | 1.5 | V | $V_{DS}=V_{GS}, I_D=1\text{mA}$ |
| Input Current | I_{IN} | | 60 | 100 | μA | $V_{IN}=+3\text{V}$ |
| Input Current | I_{IN} | | 120 | 200 | μA | $V_{IN}=+5\text{V}$ |
| Input Current while over temperature active | | | | 300 | μA | $V_{IN}=+5\text{V}$ |
| Static Drain-Source On-State Resistance | $R_{DS(on)}$ | | 170 | 250 | $\text{m}\Omega$ | $V_{IN}=+3\text{V}, I_D=1\text{A}$ |
| Static Drain-Source On-State Resistance | $R_{DS(on)}$ | | 150 | 200 | $\text{m}\Omega$ | $V_{IN}=+5\text{V}, I_D=1\text{A}$ |
| Continuous Drain Current (a) | I_D | 1.4 | | | A | $V_{IN}=3\text{V}; T_A=25^{\circ}\text{C}$ |
| Continuous Drain Current (a) | I_D | 1.6 | | | A | $V_{IN}=5\text{V}; T_A=25^{\circ}\text{C}$ |
| Continuous Drain Current (b) | I_D | 1.9 | | | A | $V_{IN}=3\text{V}; T_A=25^{\circ}\text{C}$ |
| Continuous Drain Current (b) | I_D | 2.0 | | | A | $V_{IN}=5\text{V}; T_A=25^{\circ}\text{C}$ |
| Current Limit (d) | $I_{D(LIM)}$ | 2.2 | 5 | | A | $V_{IN}=+3\text{V},$ |
| Current Limit (d) | $I_{D(LIM)}$ | 3.3 | 7 | | A | $V_{IN}=+5\text{V}$ |
| Dynamic Characteristics | | | | | | |
| Turn On Delay Time | $t_{d(on)}$ | | 6 | | μs | $V_{DD}=12\text{V}, I_D=1\text{A}, V_{GS}=5\text{V}$ |
| Rise time | t_r | | 14 | | μs | |
| Turn Off Delay Time | $t_{d(off)}$ | | 34 | | μs | |
| Fall Time | f_f | | 19 | | μs | |

Notes:

- (d) The drain current is restricted only when the device is in saturation (see graph 'typical output characteristic'). This allows the device to be used in the fully on state without interference from the current limit. The device is fully protected at all drain currents, as the low power dissipation generated outside saturation makes current limit unnecessary.

| PARAMETER | SYMBOL | MIN | TYP | MAX | UNIT | CONDITIONS |
|---------------------------------------|-----------------|-----|-----|-----|------|------------|
| Over-temperature Protection | | | | | | |
| Thermal Overload Trip Temperature (e) | T _{JT} | 150 | 175 | | °C | |
| Thermal hysteresis (e) | | | 10 | | °C | |

Note:

- (e) Over-temperature protection is designed to prevent device destruction under fault conditions. Fault conditions are considered as “outside” normal operating range, so this part is not designed to withstand over-temperature for extended periods..

TYPICAL CHARACTERISTICS

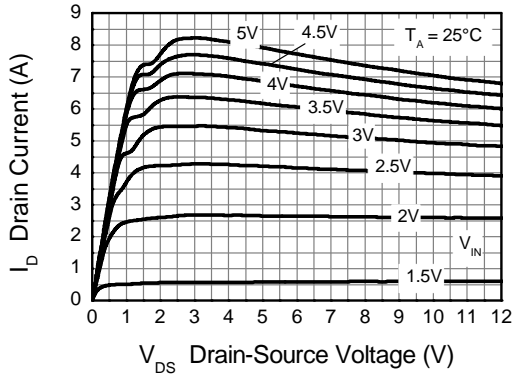

Typical Output Characteristic

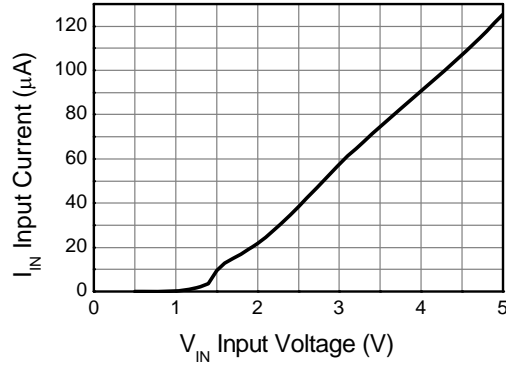

Input Current vs Input Voltage

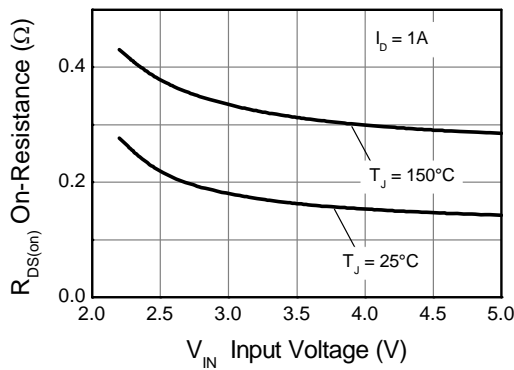

On-Resistance vs Input Voltage

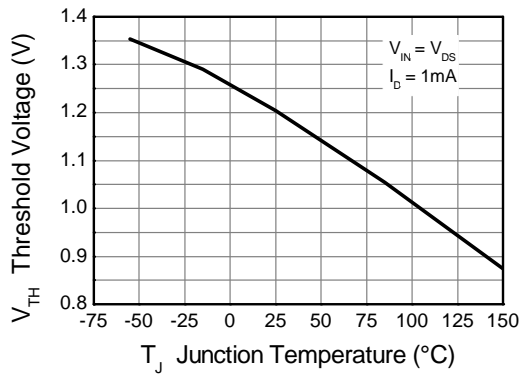

Threshold Voltage vs Temperature

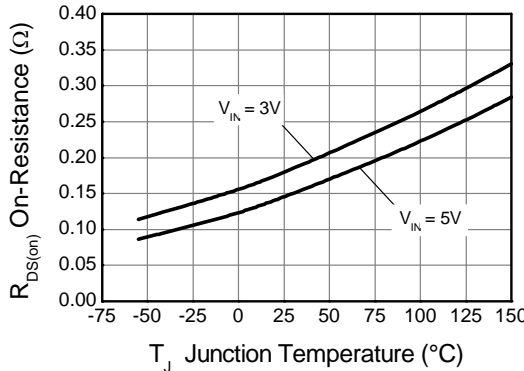

On-Resistance vs Temperature

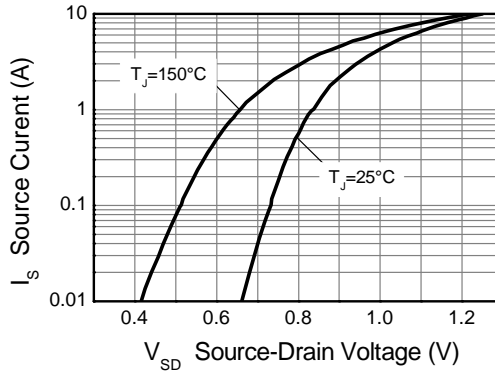

Reverse Diode Characteristic

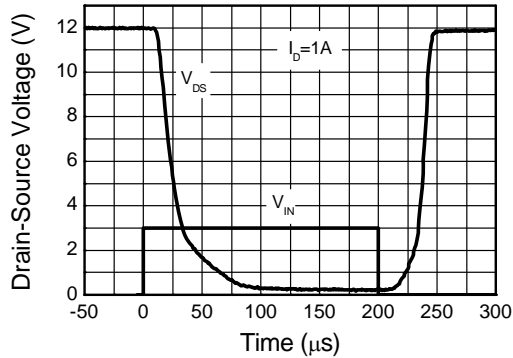

Switching Speed

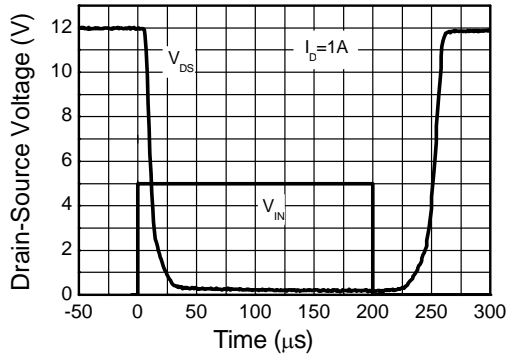

Switching Speed

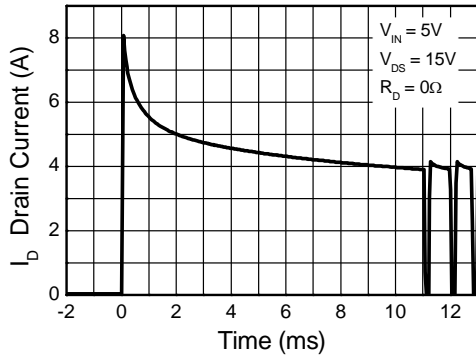

Typical Short Circuit Protection

IMPORTANT NOTICE

DIODES INCORPORATED MAKES NO WARRANTY OF ANY KIND, EXPRESS OR IMPLIED, WITH REGARDING TO THIS DOCUMENT, INCLUDING, BUT NOT LIMITED TO, THE IMPLIED WARRANTIES OF MERCHANTABILITY AND FITNESS FOR A PARTICULAR PURPOSE (AND THEIR EQUIVALENTS UNDER THE LAWS OF ANY JURISDICTION).

Diodes Incorporated and its subsidiaries reserve the right to make modifications, enhancements, improvements, corrections or other changes without further notice to this document and any product described herein. Diodes Incorporated does not assume any liability arising out of the application or use of this document or any product described herein; neither does Diodes Incorporated convey any license under its patent or trademark rights, nor the rights of others. Any Customer or user of this document or products described herein in such applications shall assume all risks of such use and will agree to hold Diodes Incorporated and all the companies whose products are represented on Diodes Incorporated website, harmless against all damages.

Diodes Incorporated does not warrant or accept any liability whatsoever in respect of any products purchased through unauthorized sales channel.

Should Customers purchase or use Diodes Incorporated products for any unintended or unauthorized application, Customers shall indemnify and hold Diodes Incorporated and its representatives harmless against all claims, damages, expenses, and attorney fees arising out of, directly or indirectly, any claim of personal injury or death associated with such unintended or unauthorized application.

Products described herein may be covered by one or more United States, international or foreign patents pending. Product names and markings noted herein may also be covered by one or more United States, international or foreign trademarks.

LIFE SUPPORT

Diodes Incorporated products are specifically not authorized for use as critical components in life support devices or systems without the express written approval of the Chief Executive Officer of Diodes Incorporated. As used herein:

A. Life support devices or systems are devices or systems which:

1. are intended to implant into the body, or
2. support or sustain life and whose failure to perform when properly used in accordance with instructions for use provided in the labeling can be reasonably expected to result in significant injury to the user.

B. A critical component is any component in a life support device or system whose failure to perform can be reasonably expected to cause the failure of the life support device or to affect its safety or effectiveness.

Customers represent that they have all necessary expertise in the safety and regulatory ramifications of their life support devices or systems, and acknowledge and agree that they are solely responsible for all legal, regulatory and safety-related requirements concerning their products and any use of Diodes Incorporated products in such safety-critical, life support devices or systems, notwithstanding any devices- or systems-related information or support that may be provided by Diodes Incorporated. Further, Customers must fully indemnify Diodes Incorporated and its representatives against any damages arising out of the use of Diodes Incorporated products in such safety-critical, life support devices or systems.

Copyright © 2010, Diodes Incorporated

www.diodes.com

Данный компонент на территории Российской Федерации

Вы можете приобрести в компании MosChip.

Для оперативного оформления запроса Вам необходимо перейти по данной ссылке:

<http://moschip.ru/get-element>

Вы можете разместить у нас заказ для любого Вашего проекта, будь то серийное производство или разработка единичного прибора.

В нашем ассортименте представлены ведущие мировые производители активных и пассивных электронных компонентов.

Нашей специализацией является поставка электронной компонентной базы двойного назначения, продукции таких производителей как XILINX, Intel (ex.ALTERA), Vicor, Microchip, Texas Instruments, Analog Devices, Mini-Circuits, Amphenol, Glenair.

Сотрудничество с глобальными дистрибьюторами электронных компонентов, предоставляет возможность заказывать и получать с международных складов практически любой перечень компонентов в оптимальные для Вас сроки.

На всех этапах разработки и производства наши партнеры могут получить квалифицированную поддержку опытных инженеров.

Система менеджмента качества компании отвечает требованиям в соответствии с ГОСТ Р ИСО 9001, ГОСТ РВ 0015-002 и ЭС РД 009

Офис по работе с юридическими лицами:

105318, г.Москва, ул.Щербаковская д.3, офис 1107, 1118, ДЦ «Щербаковский»

Телефон: +7 495 668-12-70 (многоканальный)

Факс: +7 495 668-12-70 (доб.304)

E-mail: info@moschip.ru

Skype отдела продаж:

moschip.ru

moschip.ru_4

moschip.ru_6

moschip.ru_9