

SURFACE MOUNT WHITE LED TOP VIEW 3.0 X 2.0 X 1.3mm

FEATURES

TOP VIEW WHITE
LED (3.0 x 2.0 x 1.3mm)
WHITE SMT PACKAGE
LEAD FRAME PACKAGE WITH INDIVIDUAL 2-PINS
GaN WITH YELLOW PHOSPHOR
WIDE VIEW ANGLE (X: 120°/Y: 120°)
IR REFLOW SOLDERING
ESD PROTECTION
Pb FREE

DIMENSIONS

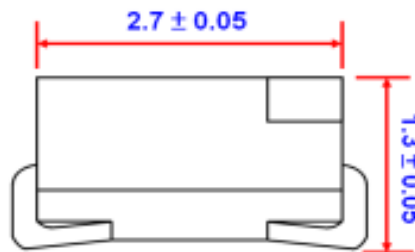
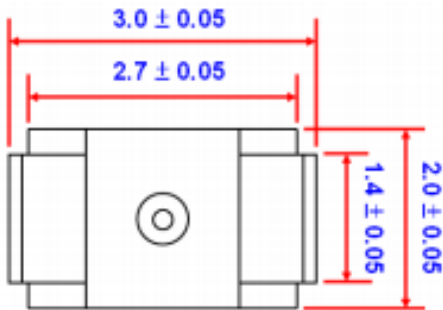
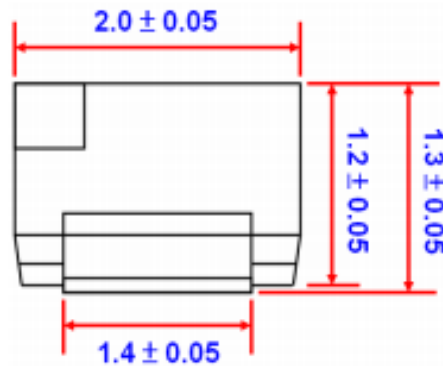
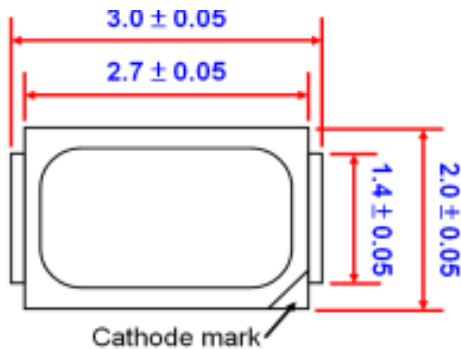

Recommended soldering pad design

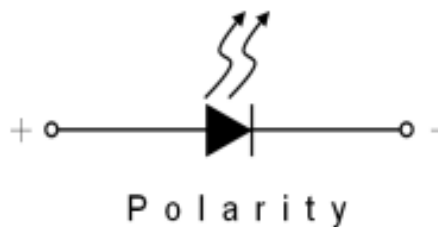
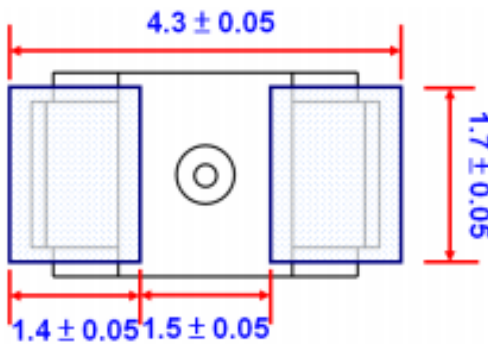

UNIT: mm



JKL PART NO.: ZSM-T3020-W

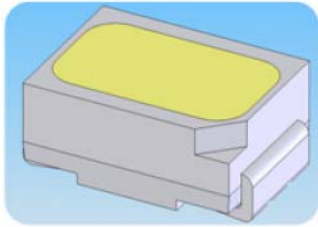

SURFACE MOUNT WHITE LED TOP VIEW 3.0 X 2.0 X 1.3mm

SPECIFICATIONS

ABSOLUTE MAXIMUM RATINGS (TA = 25°C)
(LED die)

ITEM	SYMBOL	ABSOLUTE MAXIMUM RATING	UNIT
Forward Current	I_F	30	mA
Pulse Forward Current*	I_{FP}	100	mA
Reverse Voltage	V_R	5	V
Power Dissipation	P_D	110	mW
Operating Temperature	T_{opr}	-30 ~ +85	°C
Storage Temperature	T_{stg}	-40 ~ +100	°C
Soldering Temperature	T_{sld}	Reflow Soldering: 260° C for 10 secs Hand Soldering: 350° C for 3 secs	

* I_{FP} Conditions: Pulse Width ≤ 10 msec, and duty $\leq 1/10$

ELECTRICAL & OPTICAL OPERATING CHARACTERISTICS (TA = 25°C)

ITEM	SYMBOL	CONDITION	MIN	MAX	UNIT
Forward Voltage	V_F	$I_F = 20$ mA	2.9	3.5	Volt
Luminous Intensity	L_V	$I_F = 20$ mA	1400	2200	mcd
Color Coordinates	x, y	$I_F = 20$ mA	.262	.315	x
			.245	.315	y
Viewing Angle	---	$I_F = 20$ mA	120° x	120° y	Degrees

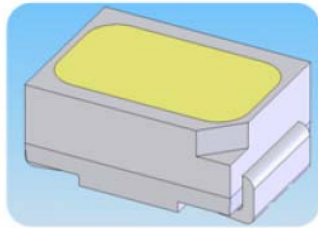

SURFACE MOUNT WHITE LED TOP VIEW 3.0 X 2.0 X 1.3mm

BIN RANGE OF CHROMATICITY COORDINATES

	CIE-X	CIE-Y		CIE-X	CIE-Y		CIE-X	CIE-Y
Aa	0.3075	0.3150	A0	0.3025	0.3050	A1	0.2970	0.2950
	0.3025	0.3050		0.2970	0.2950		0.2915	0.2850
	0.2950	0.3050		0.2895	0.2950		0.2840	0.2850
	0.3000	0.3150		0.2950	0.3050		0.2895	0.2950
A2	0.2915	0.2850	A3	0.2860	0.2750	A4	0.2805	0.2650
	0.2860	0.2750		0.2805	0.2650		0.2750	0.2550
	0.2785	0.2750		0.2730	0.2650		0.2675	0.2550
	0.2840	0.2850		0.2785	0.2750		0.2730	0.2650
A5	0.2750	0.2550	Ba	0.3150	0.3150	B0	0.3100	0.3050
	0.2695	0.2450		0.3100	0.3050		0.3045	0.2950
	0.2620	0.2450		0.3025	0.3050		0.2970	0.2950
	0.2675	0.2550		0.3075	0.3150		0.3025	0.3050
B1	0.3045	0.2950	B2	0.2990	0.2850	B3	0.2935	0.2750
	0.2990	0.2850		0.2935	0.2750		0.2880	0.2650
	0.2915	0.2850		0.2860	0.2750		0.2805	0.2650
	0.2970	0.2950		0.2915	0.2850		0.2860	0.2750
B4	0.2880	0.2650	B5	0.2825	0.2550			
	0.2825	0.2550		0.2770	0.2450			
	0.2750	0.2550		0.2695	0.2450			
	0.2805	0.2650		0.2750	0.2550			

*If color binning is required, only one color group is allowed for each chip within a reel.

Chromaticity coordinate groups are measured with an accuracy of ±0.01.

*Color coordinate is derived from the CIE 1931 chromaticity.

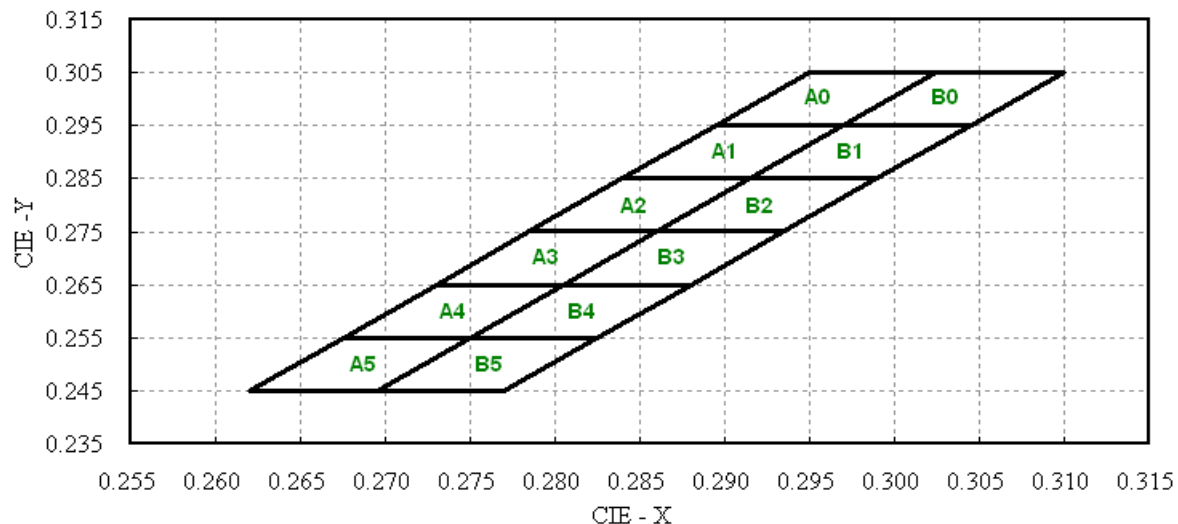

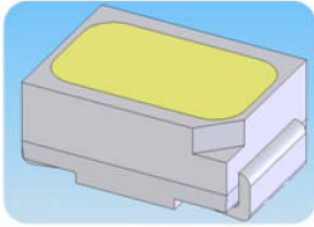

SURFACE MOUNT WHITE LED TOP VIEW 3.0 X 2.0 X 1.3mm

TYPICAL ELECTRO-OPTICAL CHARACTERISTICS CURVES

Spectrum

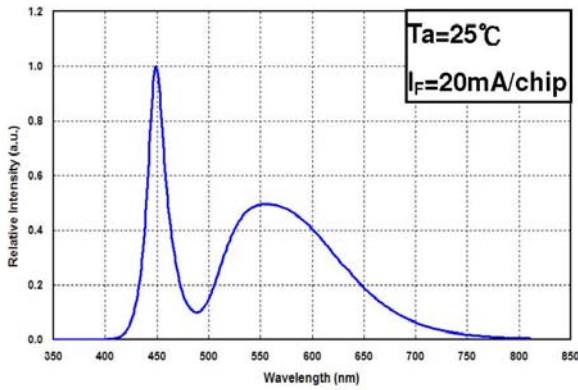

Luminous intensity — I_f

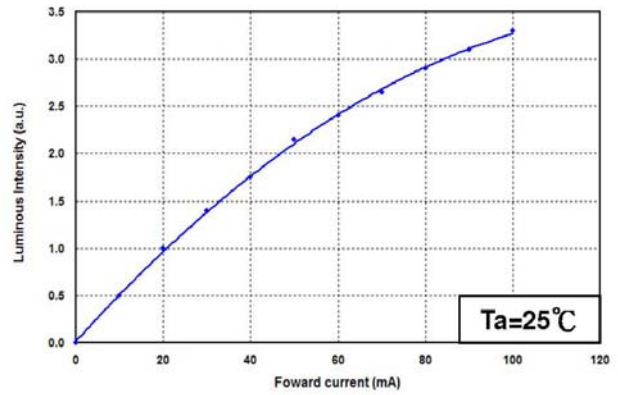

$I_f - V_f$

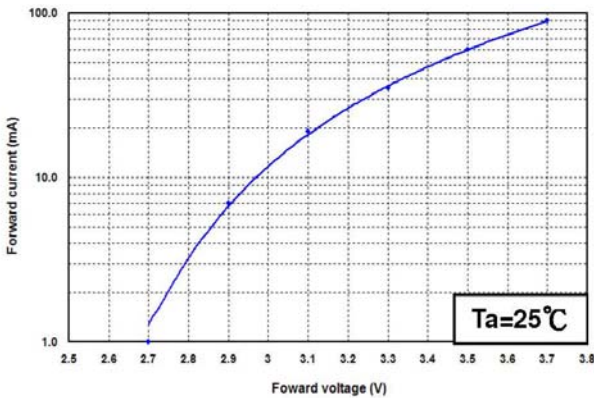

$I_f - T_a$

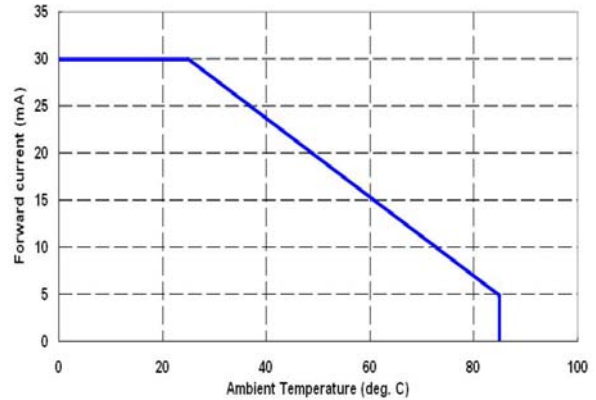

Radiation Pattern

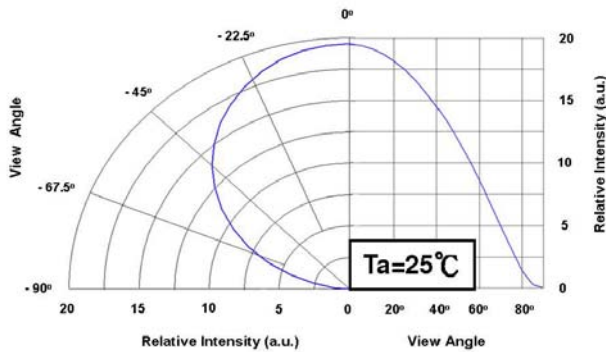

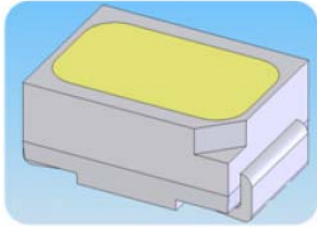

SURFACE MOUNT WHITE LED TOP VIEW 3.0 X 2.0 X 1.3mm

LEAD-FREE SOLDER

Classification Reflow Profile (JEDEC J-STD-335C)

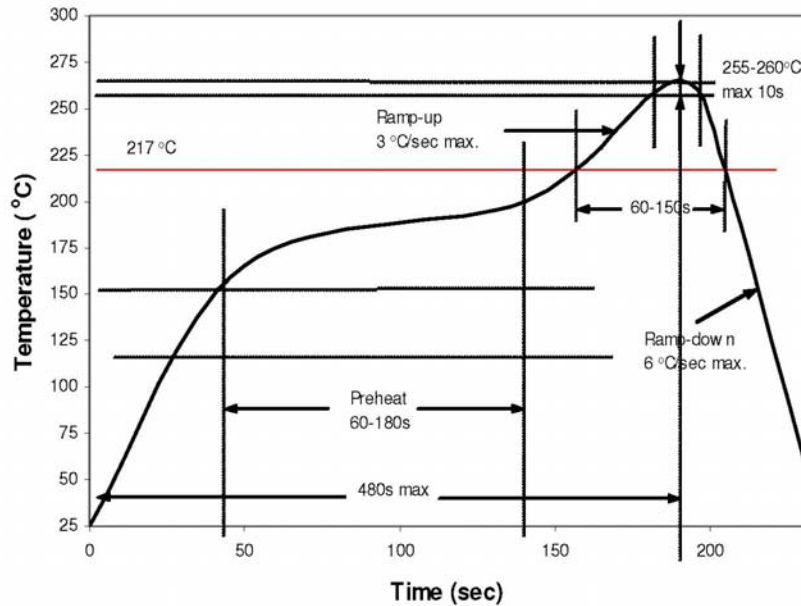

PACKAGING: 2500 pcs/REEL

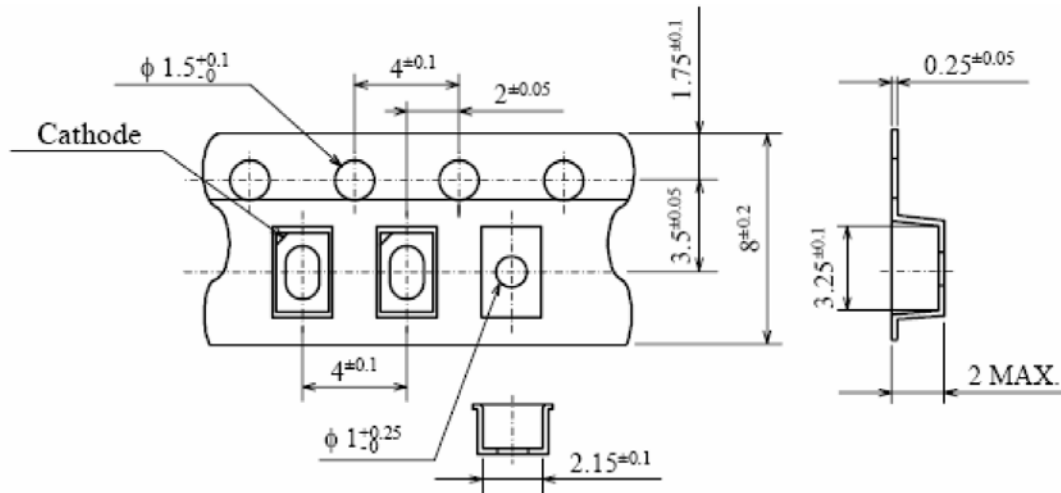

NOTES:

1. STORE IN ORIGINAL MOISTURE PROOF PACKAGING.
2. PACKAGING SHOULD BE STORED AT 30°C OR LESS AND AT 60% RH OR LESS.
3. LED SHOULD BE SOLDERED WITHIN 168 HOURS AFTER OPENING.
4. LED'S ARE STATIC SENSITIVE DEVICES. DO NOT HANDLE WITHOUT APPROPRIATE STATIC PROTECTION.
5. CLEAN ONLY WITH ISOPROPYL ALCOHOL. DO NOT USE ULTRASONIC CLEANING.
6. **CAUTION:** DO NOT LOOK DIRECTLY INTO LIT LED. INJURY TO EYES CAN OCCUR.

Данный компонент на территории Российской Федерации

Вы можете приобрести в компании MosChip.

Для оперативного оформления запроса Вам необходимо перейти по данной ссылке:

<http://moschip.ru/get-element>

Вы можете разместить у нас заказ для любого Вашего проекта, будь то серийное производство или разработка единичного прибора.

В нашем ассортименте представлены ведущие мировые производители активных и пассивных электронных компонентов.

Нашей специализацией является поставка электронной компонентной базы двойного назначения, продукции таких производителей как XILINX, Intel (ex.ALTERA), Vicor, Microchip, Texas Instruments, Analog Devices, Mini-Circuits, Amphenol, Glenair.

Сотрудничество с глобальными дистрибьюторами электронных компонентов, предоставляет возможность заказывать и получать с международных складов практически любой перечень компонентов в оптимальные для Вас сроки.

На всех этапах разработки и производства наши партнеры могут получить квалифицированную поддержку опытных инженеров.

Система менеджмента качества компании отвечает требованиям в соответствии с ГОСТ Р ИСО 9001, ГОСТ РВ 0015-002 и ЭС РД 009

Офис по работе с юридическими лицами:

105318, г.Москва, ул.Щербаковская д.3, офис 1107, 1118, ДЦ «Щербаковский»

Телефон: +7 495 668-12-70 (многоканальный)

Факс: +7 495 668-12-70 (доб.304)

E-mail: info@moschip.ru

Skype отдела продаж:

moschip.ru

moschip.ru_4

moschip.ru_6

moschip.ru_9