



TIG074E8

N-Channel IGBT 400V, 150A, VCE(sat); 3.8V Single ECH8

ON Semiconductor®

<http://onsemi.com>

Features

- Low-saturation voltage
- Enhancement type
- Mounting Height 0.9mm, Mounting Area 8.12mm²
- Halogen free compliance
- Low voltage drive (2.5V)
- Built-in Gate to Emitter protection diode
- dv / dt guarantee*

Application

- Light-Controlling Flash Applications

Specifications

Absolute Maximum Ratings at Ta=25°C

Parameter	Symbol	Conditions	P-channel	Unit
Collector to Emitter Voltage	V _{CES}		400	V
Gate to Emitter Voltage (DC)	V _{GES}		±4	V
Gate to Emitter Voltage (Pulse)	V _{GES}	PW≤1ms	±5	V
Collector Current (Pulse)	I _{CP}	V _{GE} =2.5V, C _M =200μF	150	A
Maximum Collector to Emitter dv / dt	dv / dt	Turn off I _C =150A, V _{CE} ≤320V, starting T _{ch} =25°C	400	V / μs
Channel Temperature	T _j		150	°C
Storage Temperature	T _{stg}		-40 to +150	°C

* : Concerning dv / dt (slope of Collector Voltage at the time of Turn-OFF), will be 100% screen-detected in the circuit shown as Fig. 1.

Stresses exceeding Maximum Ratings may damage the device. Maximum Ratings are stress ratings only. Functional operation above the Recommended Operating Conditions is not implied. Extended exposure to stresses above the Recommended Operating Conditions may affect device reliability.

Electrical Characteristics at Ta=25°C

Parameter	Symbol	Conditions	Ratings			Unit
			min	typ	max	
Collector to Emitter Breakdown Voltage	V(BR)CES	I _C =2mA, V _{GE} =0V	400			V
Collector to Emitter Cutoff Current	I _{CES}	V _{CE} =320V, V _{GE} =0V			10	μA
Gate to Emitter Leakage Current	I _{GES}	V _{GE} =±4V, V _{CE} =0V			±10	μA
Gate to Emitter Threshold Voltage	V _{GE(off)}	V _{CE} =10V, I _C =1mA	0.4		0.9	V
Collector to Emitter Saturation Voltage	V _{CE(sat)}	I _C =100A, V _{GE} =2.5V		3.8	5.4	V
Input Capacitance	C _{ies}	V _{CE} =10V, f=1MHz		3100		pF
Output Capacitance	C _{oes}				32	pF
Reverse Transfer Capacitance	C _{res}				24	pF

ORDERING INFORMATION

See detailed ordering and shipping information on page 5 of this data sheet.

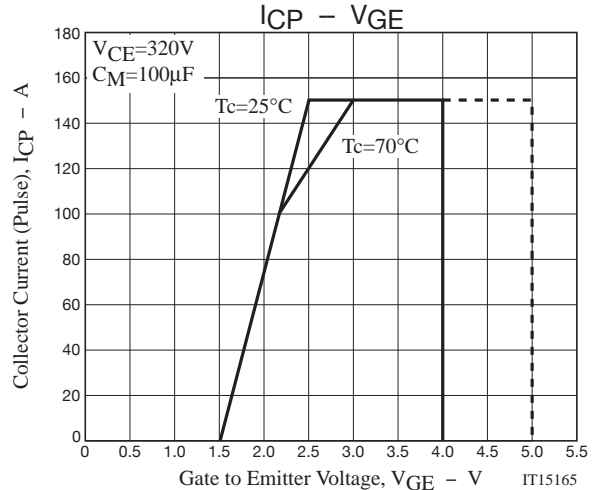
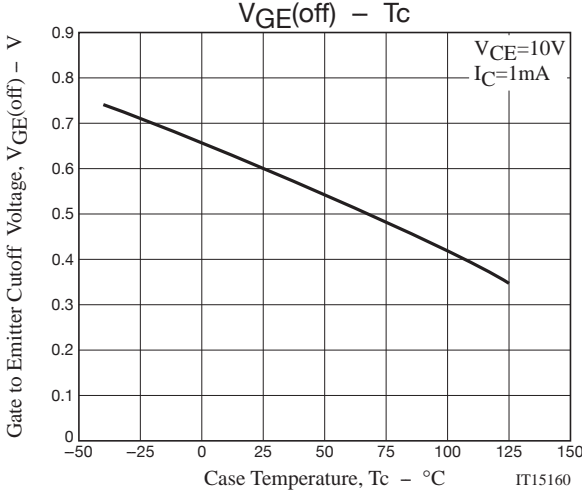
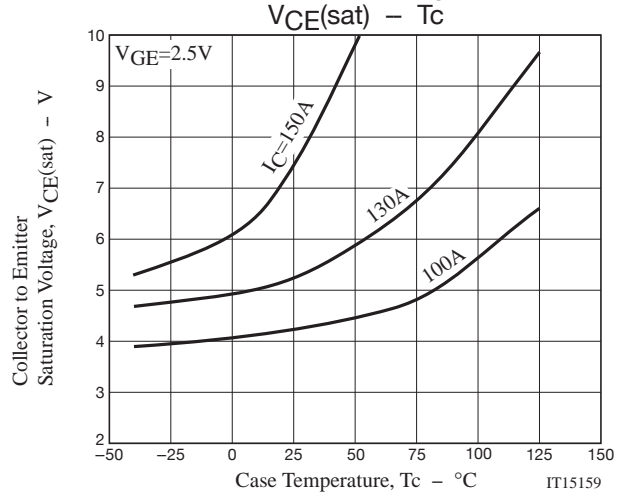
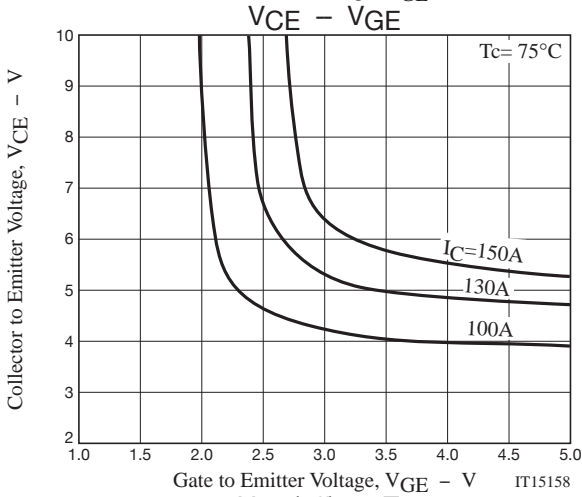
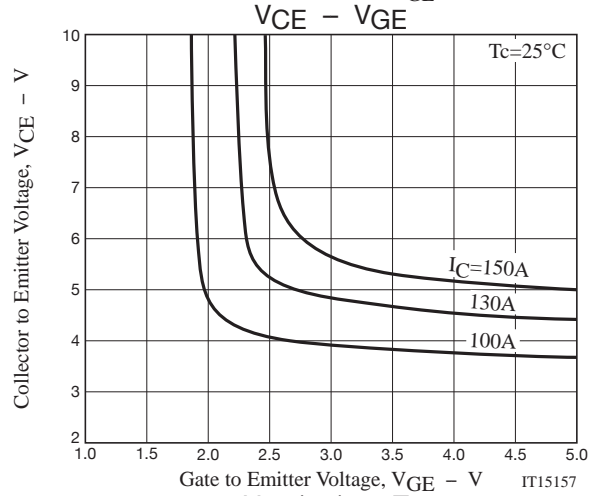
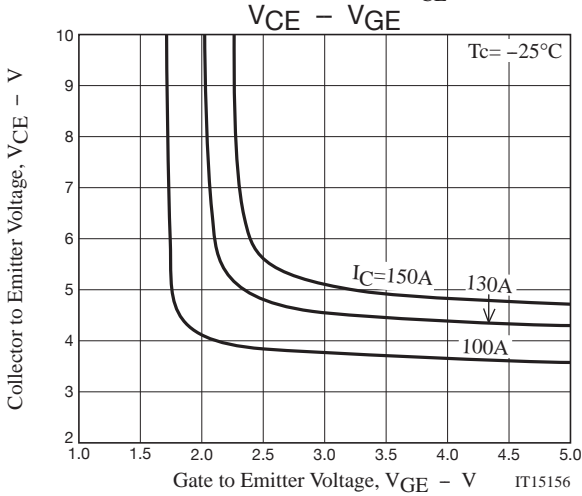
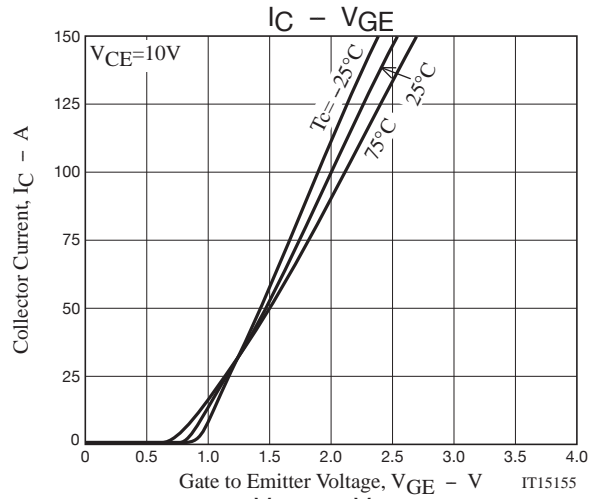
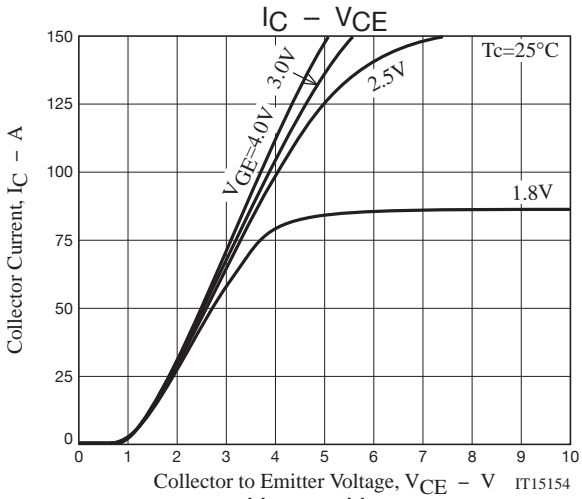

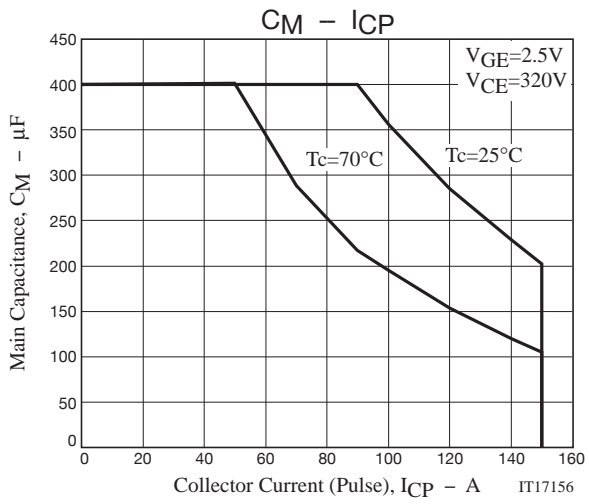
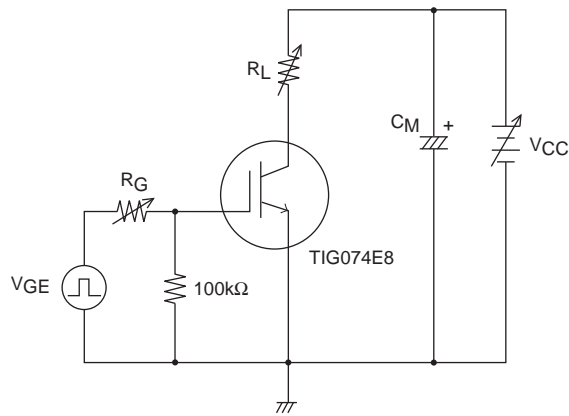

Fig.1 Large Current R Load Switching Circuit



Note1. The collector voltage gradient dv / dt - Turn off I_c safety movement domain to protect the device of Gate-series resistor R_G when it is turned off.

Definition of dv/dt

dv/dt is defined as the maximum slope of the below V_{CE} curve during turn-off period.
 $dv/dt = \Delta V_{CE} / \Delta t = \Delta V_{CE} / 100ns$

Overall waveform

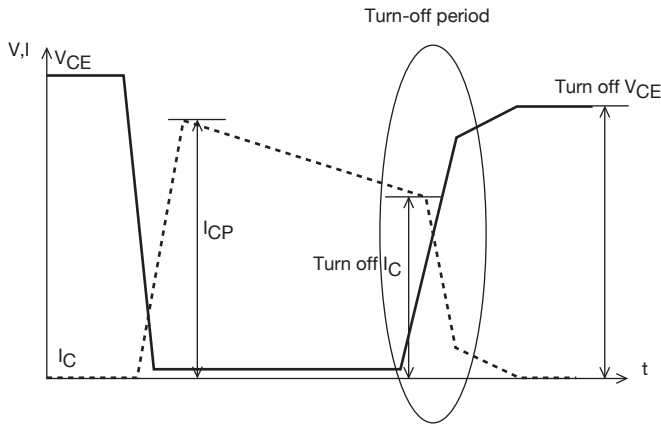

Enlarged picture of turn-off period

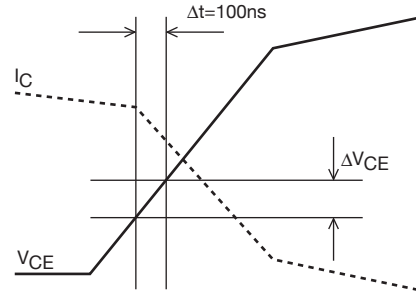

IT15323

Definition of Switching Time

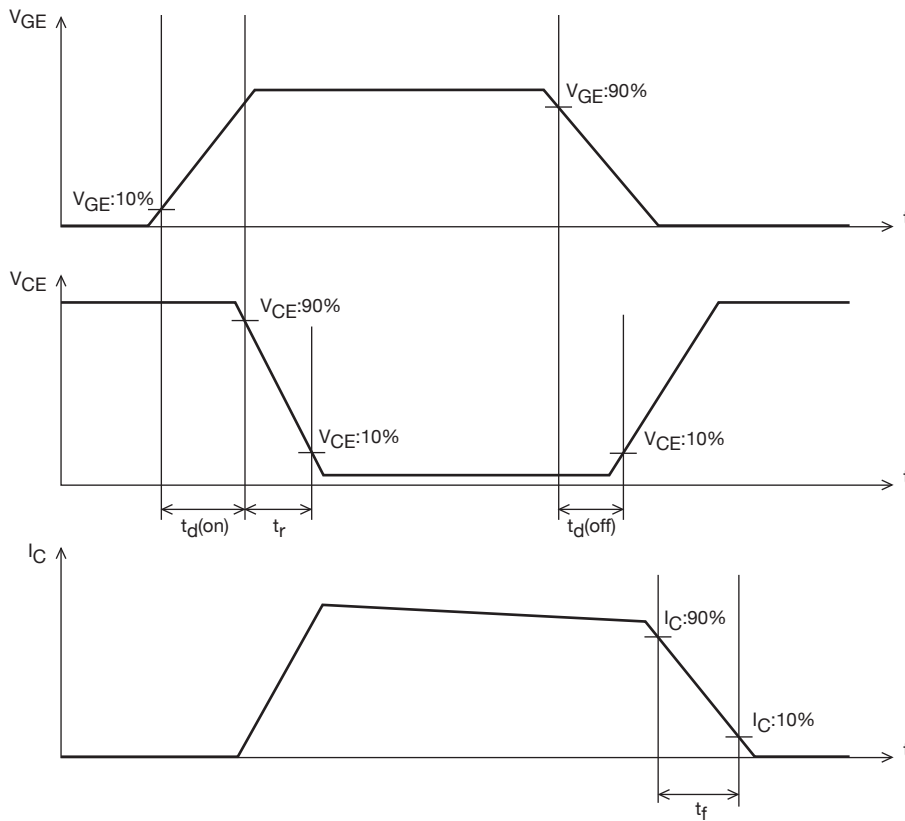

IT15324

TIG074E8

Package Dimensions

TIG074E8-TL-H

SOT-28FL/ECH8
CASE 318BF
ISSUE O

Unit : mm

- 1: Emitter
- 2: Emitter
- 3: Emitter
- 4: Gate
- 5: Collector
- 6: Collector
- 7: Collector
- 8: Collector

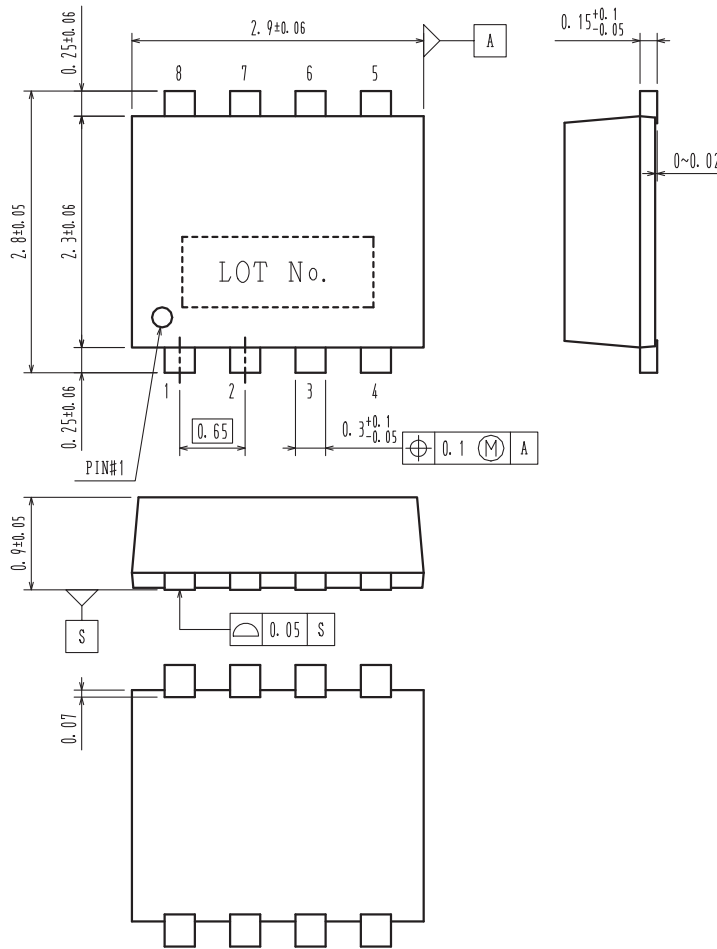

Ordering & Package Information

Device	Package	Shipping	memo
TIG074E8-TL-H	ECH8	3,000 pcs./reel	Pb-Free and Halogen Free

Packing Type: TL

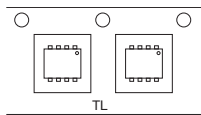

Marking

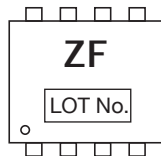

Electrical Connection

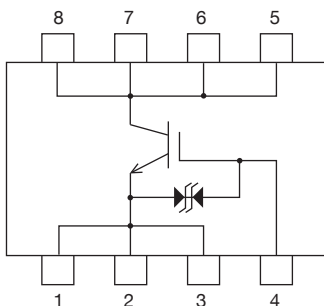

Note on usage : TIG074E8 has protection diode between gate and emitter but handling it requires sufficient care to be taken.

ON Semiconductor and the ON logo are registered trademarks of Semiconductor Components Industries, LLC (SCILLC). SCILLC owns the rights to a number of patents, trademarks, copyrights, trade secrets, and other intellectual property. A listing of SCILLC's product/patent coverage may be accessed at www.onsemi.com/site/pdf/Patent-Marking.pdf. SCILLC reserves the right to make changes without further notice to any products herein. SCILLC makes no warranty, representation or guarantee regarding the suitability of its products for any particular purpose, nor does SCILLC assume any liability arising out of the application or use of any product or circuit, and specifically disclaims any and all liability, including without limitation special, consequential or incidental damages. "Typical" parameters which may be provided in SCILLC data sheets and/or specifications can and do vary in different applications and actual performance may vary over time. All operating parameters, including "Typicals" must be validated for each customer application by customer's technical experts. SCILLC does not convey any license under its patent rights nor the rights of others. SCILLC products are not designed, intended, or authorized for use as components in systems intended for surgical implant into the body, or other applications intended to support or sustain life, or for any other application in which the failure of the SCILLC product could create a situation where personal injury or death may occur. Should Buyer purchase or use SCILLC products for any such unintended or unauthorized application, Buyer shall indemnify and hold SCILLC and its officers, employees, subsidiaries, affiliates, and distributors harmless against all claims, costs, damages, and expenses, and reasonable attorney fees arising out of, directly or indirectly, any claim of personal injury or death associated with such unintended or unauthorized use, even if such claim alleges that SCILLC was negligent regarding the design or manufacture of the part. SCILLC is an Equal Opportunity/Affirmative Action Employer. This literature is subject to all applicable copyright laws and is not for resale in any manner.

Данный компонент на территории Российской Федерации

Вы можете приобрести в компании MosChip.

Для оперативного оформления запроса Вам необходимо перейти по данной ссылке:

<http://moschip.ru/get-element>

Вы можете разместить у нас заказ для любого Вашего проекта, будь то серийное производство или разработка единичного прибора.

В нашем ассортименте представлены ведущие мировые производители активных и пассивных электронных компонентов.

Нашей специализацией является поставка электронной компонентной базы двойного назначения, продукции таких производителей как XILINX, Intel (ex.ALTERA), Vicor, Microchip, Texas Instruments, Analog Devices, Mini-Circuits, Amphenol, Glenair.

Сотрудничество с глобальными дистрибьюторами электронных компонентов, предоставляет возможность заказывать и получать с международных складов практически любой перечень компонентов в оптимальные для Вас сроки.

На всех этапах разработки и производства наши партнеры могут получить квалифицированную поддержку опытных инженеров.

Система менеджмента качества компании отвечает требованиям в соответствии с ГОСТ Р ИСО 9001, ГОСТ РВ 0015-002 и ЭС РД 009

Офис по работе с юридическими лицами:

105318, г.Москва, ул.Щербаковская д.3, офис 1107, 1118, ДЦ «Щербаковский»

Телефон: +7 495 668-12-70 (многоканальный)

Факс: +7 495 668-12-70 (доб.304)

E-mail: info@moschip.ru

Skype отдела продаж:

moschip.ru

moschip.ru_4

moschip.ru_6

moschip.ru_9