

**SINGLE PHASE FULL WAVE DIRECT PWM MOTOR DRIVER****AM4961****General Description**

The AM4961 is a full wave driver IC with PWM control function. It is used for single phase motor and is capable of speed control by changing output duty cycle.

The AM4961 is available in TSSOP-20(EDP) and HTSSOP-14 packages.

Features

- Built-in Hall Bias Circuit
- Built-in PWM Speed Control Circuit
- Built-in Minimal Speed Setup Circuit
- Rotation Speed Indication (FG)
- Rotation or Lock State Indication (RD)
- Built-in Thermal Shutdown Circuit
- Lock Protection
- Output Current Limit

Application

- CPU Cooler Fan in PC
- Brushless DC Motor Driver

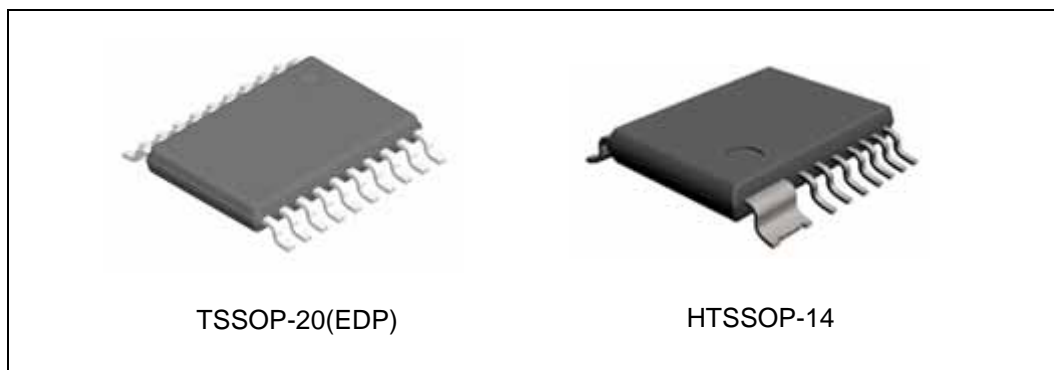

Figure 1. Package Types of AM4961



SINGLE PHASE FULL WAVE DIRECT PWM MOTOR DRIVER

AM4961

Pin Configuration

G Package
(TSSOP-20(EDP))

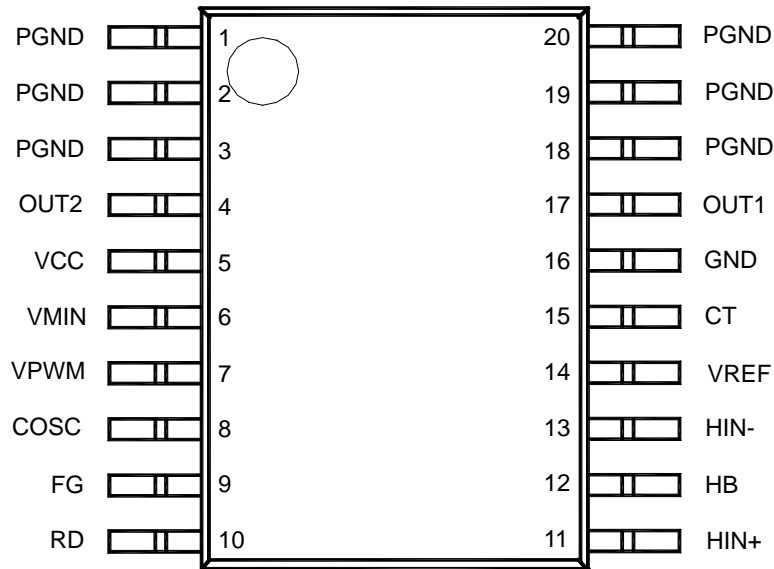

Pin Configuration (Continued)

GH Package
(HTSSOP-14)

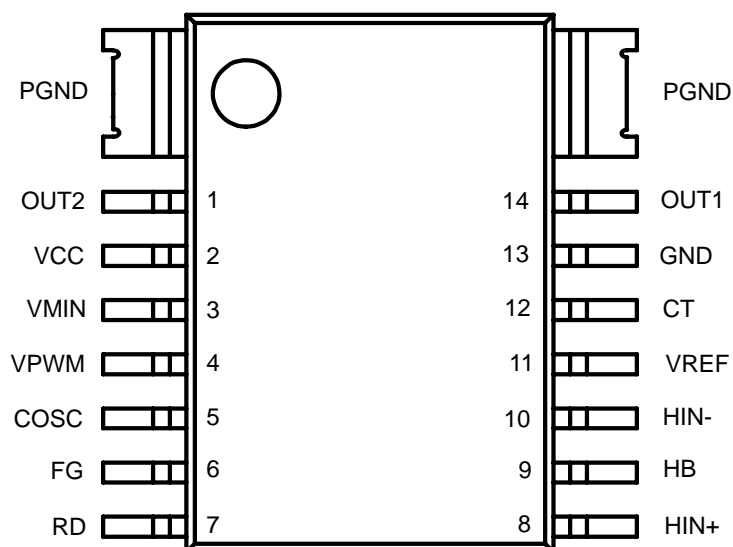

Figure 2. Pin Configuration of AM4961 (Top View)

**SINGLE PHASE FULL WAVE DIRECT PWM MOTOR DRIVER****AM4961****Pin Description**

Pin Number		Pin Name	Function
TSSOP-20(EDP)	HTSSOP-14		
1		PGND	Power ground
2		PGND	Power ground
3		PGND	Power ground
4	1	OUT2	Driver output 2
5	2	VCC	Power supply
6	3	VMIN	Minimum duty setting
7	4	VPWM	Adjustable Input
8	5	COSC	Oscillator capacitor
9	6	FG	Rotation speed indicator
10	7	RD	Rotation/lock state indicator
11	8	HIN+	Hall sensor input +
12	9	HB	Hall sensor bias regulator
13	10	HIN-	Hall sensor input -
14	11	VREF	Reference voltage regulator
15	12	CT	Lock and rotation setting capacitor terminal
16	13	GND	Ground for control circuit
17	14	OUT1	Driver output 1
18		PGND	Power ground
19		PGND	Power ground
20		PGND	Power ground



SINGLE PHASE FULL WAVE DIRECT PWM MOTOR DRIVER

AM4961

Functional Block Diagram

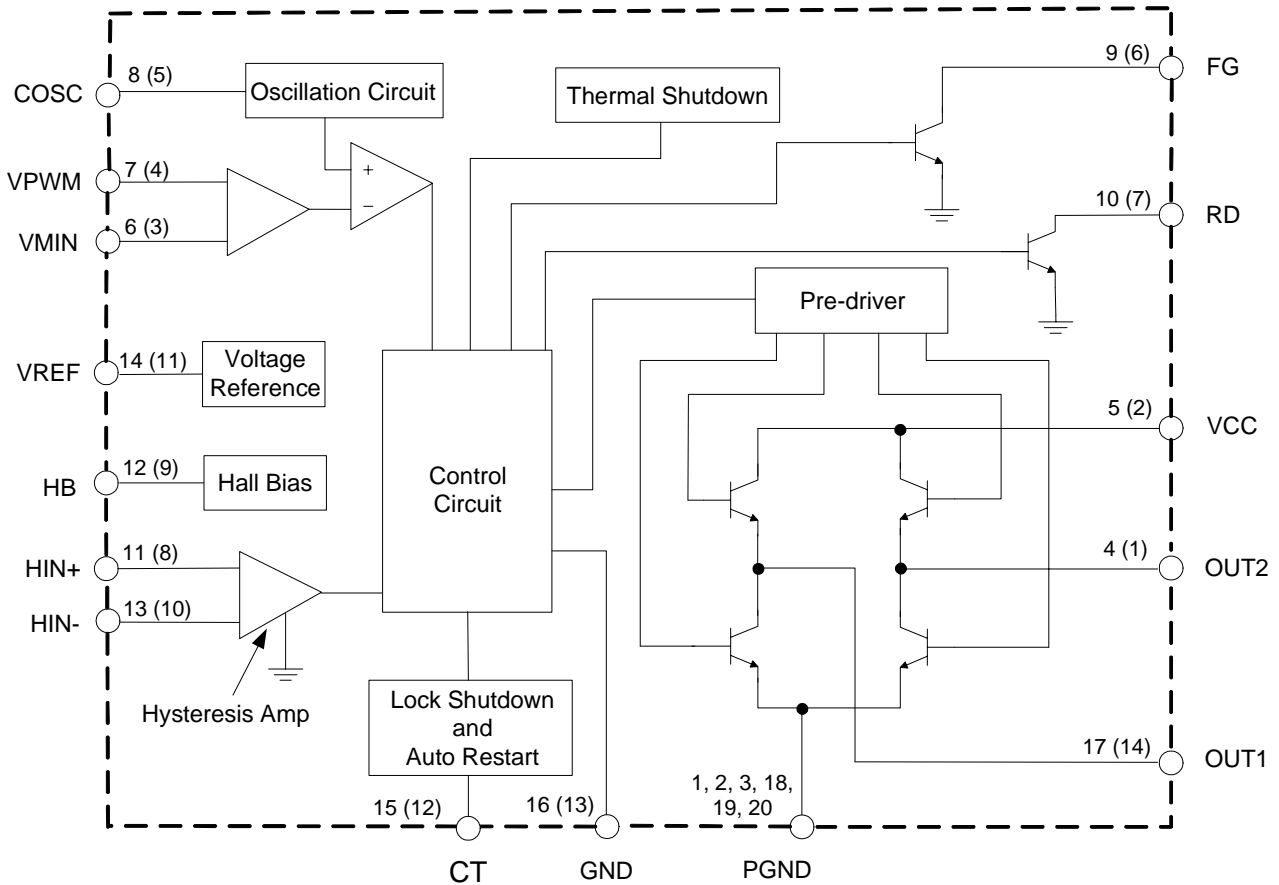

A (B)
A for 20-pin B for 14-pin

Figure 3. Functional Block Diagram of AM4961



SINGLE PHASE FULL WAVE DIRECT PWM MOTOR DRIVER **AM4961**

Truth Table

HIN-	HIN+	COSC (Note 1)	CT	OUT1	OUT2	FG	RD	Mode
H	L	H	L	H	L	L	L	Rotation (Drive)
L	H			L	H	OFF		
H	L	L		OFF	L	L		Rotation (Recirculate)
L	H			L	OFF	OFF		
H	L	H	H	H	OFF	L	OFF	Lock Protection
L	H			OFF	H	OFF		
H	L	L		OFF	OFF	L		
L	H			OFF	OFF	OFF		

Note 1: $V_{OSC(H)} > V_{PWM}$, $V_{OSC(L)} < V_{PWM}$.

Ordering Information

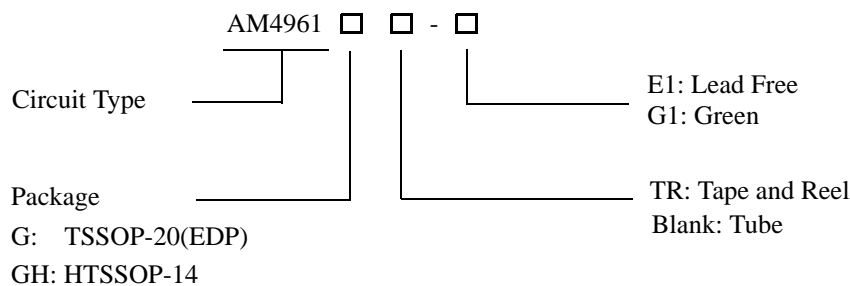

Package	Temperature Range	Part Number		Marking ID		Packing Type
		Lead Free	Green	Lead Free	Green	
TSSOP-20 (EDP)	-30 to 105°C	AM4961G-E1	AM4961G-G1	AM4961G	AM4961G-G1	Tube
		AM4961GTR-E1	AM4961GTR-G1	AM4961G	AM4961G-G1	Tape & Reel
HTSSOP-14	-30 to 90°C	AM4961GH-E1	AM4961GH-G1	AM4961GH	AM4961GH-G1	Tube
		AM4961GHTR-E1	AM4961GHTR-G1	AM4961GH	AM4961GH-G1	Tape & Reel

BCD Semiconductor's Pb-free products, as designated with "E1" suffix in the part number, are RoHS compliant. Products with "G1" suffix are available in green packages.

**SINGLE PHASE FULL WAVE DIRECT PWM MOTOR DRIVER****AM4961****Absolute Maximum Ratings (Note 2)**

Parameter	Symbol	Value		Unit
Supply Voltage	V_{CC}	18		V
Output Current	I_{OUT}	1.2		A
Output Voltage	V_{OUT}	18		V
HB Output Current	I_{HB}	10		mA
VPWM Input Voltage	V_{PWM}	6		V
RD Output Voltage	V_{RD}	18		V
FG Output Voltage	V_{FG}	18		V
RD Output Current	I_{RD}	10		mA
FG Output Current	I_{FG}	10		mA
Power Dissipation (Note 3)	P_D	TSSOP-20(EDP)	1.5	W
		HTSSOP-14	1.1	W
Storage Temperature Range	T_{STG}	-55 to 150		°C
ESD (Human Body Model)	ESD	2000		V
ESD (Machine Model)	ESD	250		V

Note 2: Stresses greater than those listed under "Absolute Maximum Ratings" may cause permanent damage to the device. These are stress ratings only, and functional operation of the device at these or any other conditions beyond those indicated under "Recommended Operating Conditions" is not implied. Exposure to "Absolute Maximum Ratings" for extended periods may affect device reliability.

Note 3: $T_A=25^{\circ}\text{C}$, no external heatsink.

Recommended Operating Conditions

Parameter	Symbol	Min	Typ	Max	Unit
Supply Voltage	V_{CC}	3.5	12	16	V
Hall Input Voltage + (Note 4)	V_{IN+}	0.2		3	V
Hall Input Voltage - (Note 4)	V_{IN-}	0.2		3	V
Ambient Temperature (Note 5)	T_A	-30		105	°C

Note 4: Hall input voltage range includes the amplitude of signal.

Note 5: For TSSOP-20(EDP) package only. External heatsink shall larger than 15.24mm*3.81mm to ensure the IC is available at $T_A=105^{\circ}\text{C}$.

**SINGLE PHASE FULL WAVE DIRECT PWM MOTOR DRIVER****AM4961****Electrical Characteristics**(V_{CC}=12V, T_A=25°C, unless otherwise specified.)

Parameter	Symbol	Conditions	Min	Typ	Max	Unit
Quiescent Current	I _{Q1}	Lock off	11.24	15	18.76	mA
	I _{Q2}	Lock on	6.25	8	10.55	
VREF Voltage	V _{REF}	I _{REF} =5mA	5.8	6	6.2	V
Output Saturation Voltage at High Side	V _{SATH}	I _{SOURCE} =200mA		1.0	1.17	V
Output Saturation Voltage at Low Side	V _{SATL}	I _{SINK} =200mA		0.2	0.3	V
COSC Frequency	f _{OSC}	C _{OSC} =100pF	18	25	32	KHz
COSC High Level Voltage	V _{OSCH}		3.45	3.6	3.75	V
COSC Low Level Voltage	V _{OSCL}		1.83	1.95	2.07	V
Hall Input Hysteresis	V _{HYS}			±10	±20	mV
Hall Bias Voltage	V _{HB}	I _{HB} =5mA	1.1	1.25	1.4	V
CT High Level Voltage	V _{CTH}		3.55	3.7	3.88	V
CT Low Level Voltage	V _{CTL}		1.55	1.7	1.85	V
CT Charge Current	I _{CHG}		1.5	2	2.55	μA
CT Discharge Current	I _{DHG}		0.14	0.2	0.255	μA
CT Charge and Discharge Ratio	R _{CD}	I _{CHG} /I _{DHG}	8.5	10	14.5	
FG Output Low Level Voltage	V _{FGL}	I _{FG} =5mA		0.2	0.3	V
FG Leakage Current	I _{LFG}	V _{FG} =12V			30	μA
RD Output Low Level Voltage	V _{RDL}	I _{RD} =5mA		0.2	0.3	V
RD Leakage Current	I _{LRD}	V _{RD} =12V			30	μA



Typical Performance Characteristics

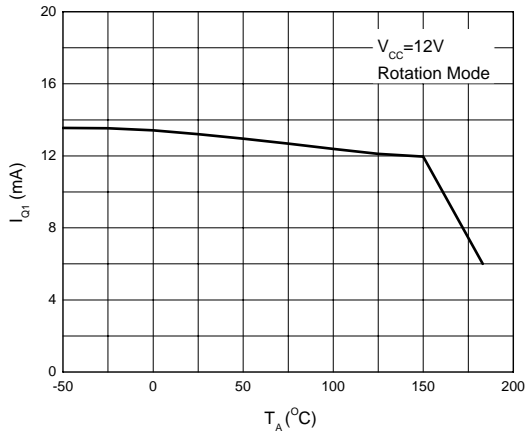

Figure 4. Quiescent Current vs. Ambient Temperature

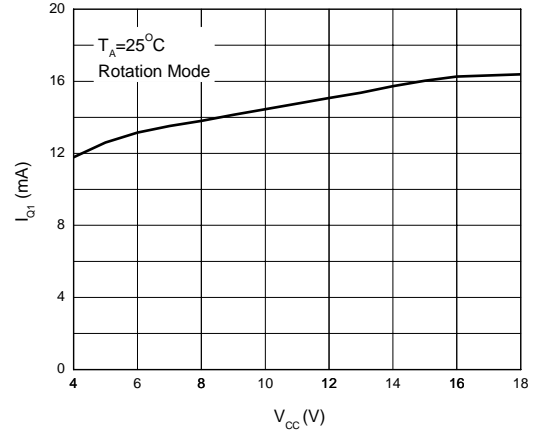

Figure 5. Quiescent Current vs. Supply Voltage

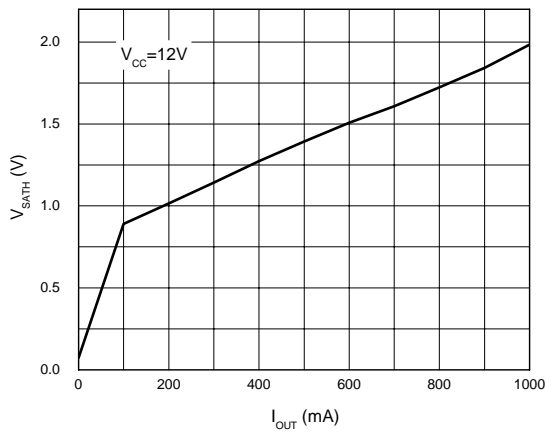

Figure 6. Output Saturation Voltage (High) vs. Output Current

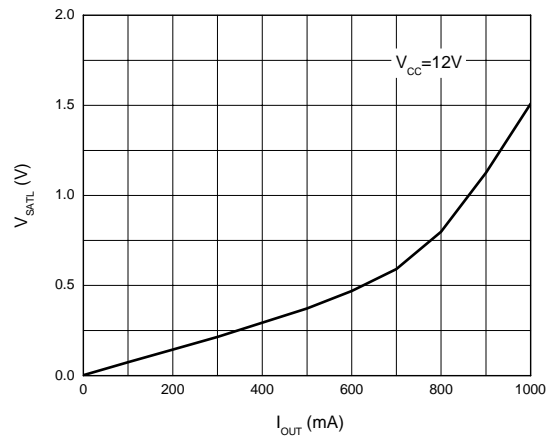

Figure 7. Output Saturation Voltage (Low) vs. Output Current



SINGLE PHASE FULL WAVE DIRECT PWM MOTOR DRIVER **AM4961**

Typical Performance Characteristics (Continued)

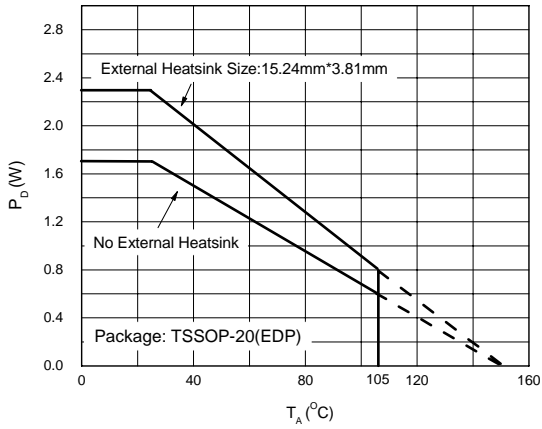

Figure 8. Power Dissipation vs. Ambient Temperature

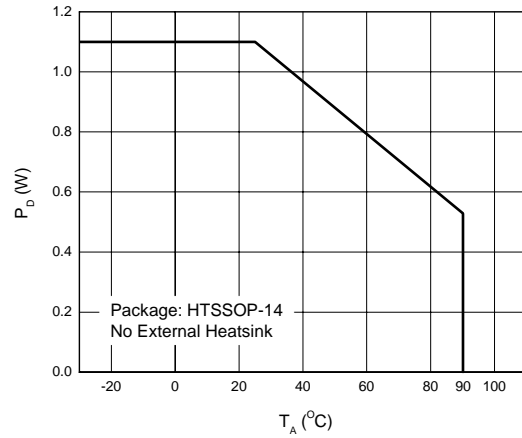

Figure 9. Power Dissipation vs. Ambient Temperature

Operating Diagram

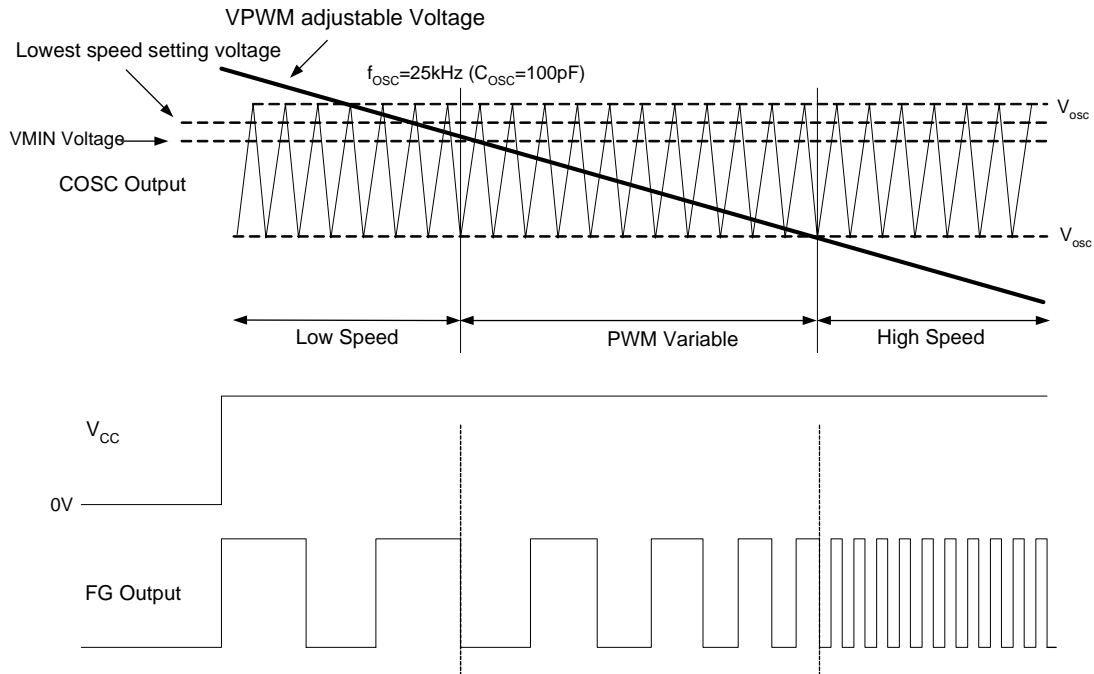

Figure 10. Operating Diagram of AM4961 (Note 6)

Note 6:

1. Low Speed Setting Mode

When VPWM voltage is higher than VMIN pin voltage, motor speed is settable by VMIN pin voltage. The minimum drive duty cycle is settable by comparing COSC oscillating voltage and VMIN pin voltage.

VPWM voltage is decided by variation of PWM duty.

2. Variable Speed Setting Mode

When VPWM voltage is lower than VMIN pin voltage, PWM control system works by comparing VPWM voltage and COSC voltage. If VPWM voltage is higher, the ON duty cycle of the upper side transistors will be minimized and motor speed becomes lower. Vice versa.

3. Full Speed Rotation Mode

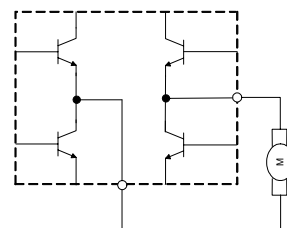

At a certain PWN duty, when VPWM voltage is lower than the low side of COSC output voltage, the motor will run at full speed.

Typical Application (Continued)

Note 7:

***1. Ground Line Layout**

PGND is connected to motor supply stage and GND is connected to control stage. All ground lines from control stage are connected to GND.

***2. Stability of Power Supply**

C1 is employed to stabilize V_{CC} . Its capacitance is no less than $1\mu F$.

***3. Hall Input**

To avoid noise, the shortest line is recommended to connect with Hall stage which has about 20mV hysteresis. Thus, the ideal Hall input is 50mV or over.

***4. COSC Capacitor**

When C_{CP} is 100pF, the COSC frequency will be 25kHz.

***5. FG Output**

FG output terminal is open collector output which varies with phase change.

***6. RD Output**

RD output terminal is open collector output. It is low at rotation mode and high when stopped.

***7. HB Pin**

This pin is available to output a 1.25V Hall bias voltage.

***8. VMIN Pin**

If this pin is disused, connect it directly with VPWM, the minimum duty cycle will be 10%.

***9. Exposed Pad (For TSSOP-20(EDP) package only)**

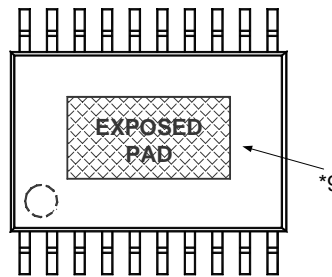

There is an exposed pad at the bottom of IC. If operating current is high, it is recommended to solder external heatsink closely with this pad by tin to ensure better temperature characteristics.



SINGLE PHASE FULL WAVE DIRECT PWM MOTOR DRIVER

AM4961

Mechanical Dimensions

TSSOP-20(EDP)

Unit: mm(inch)

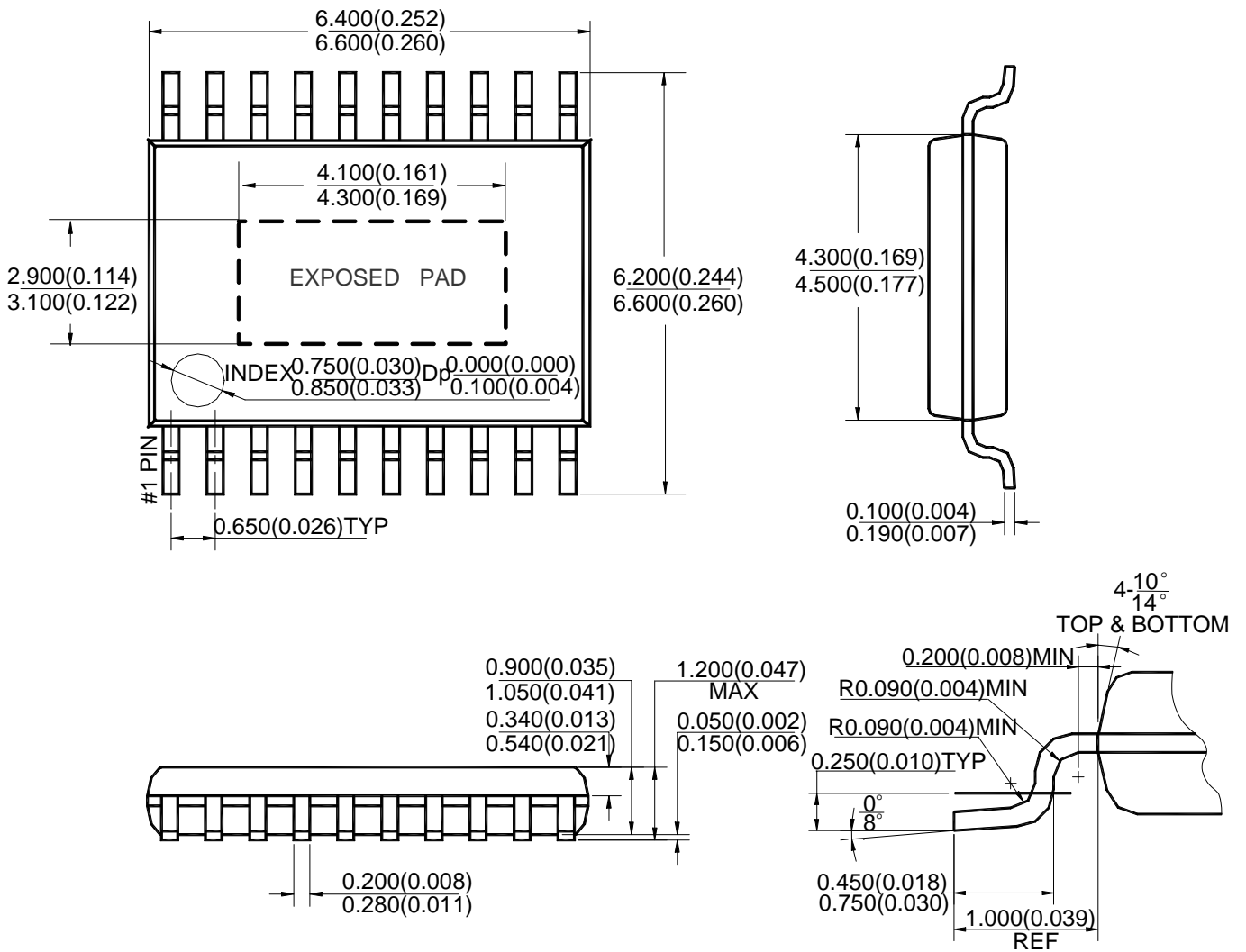



SINGLE PHASE FULL WAVE DIRECT PWM MOTOR DRIVER

AM4961

Mechanical Dimensions (Continued)

HTSSOP-14

Unit: mm(inch)

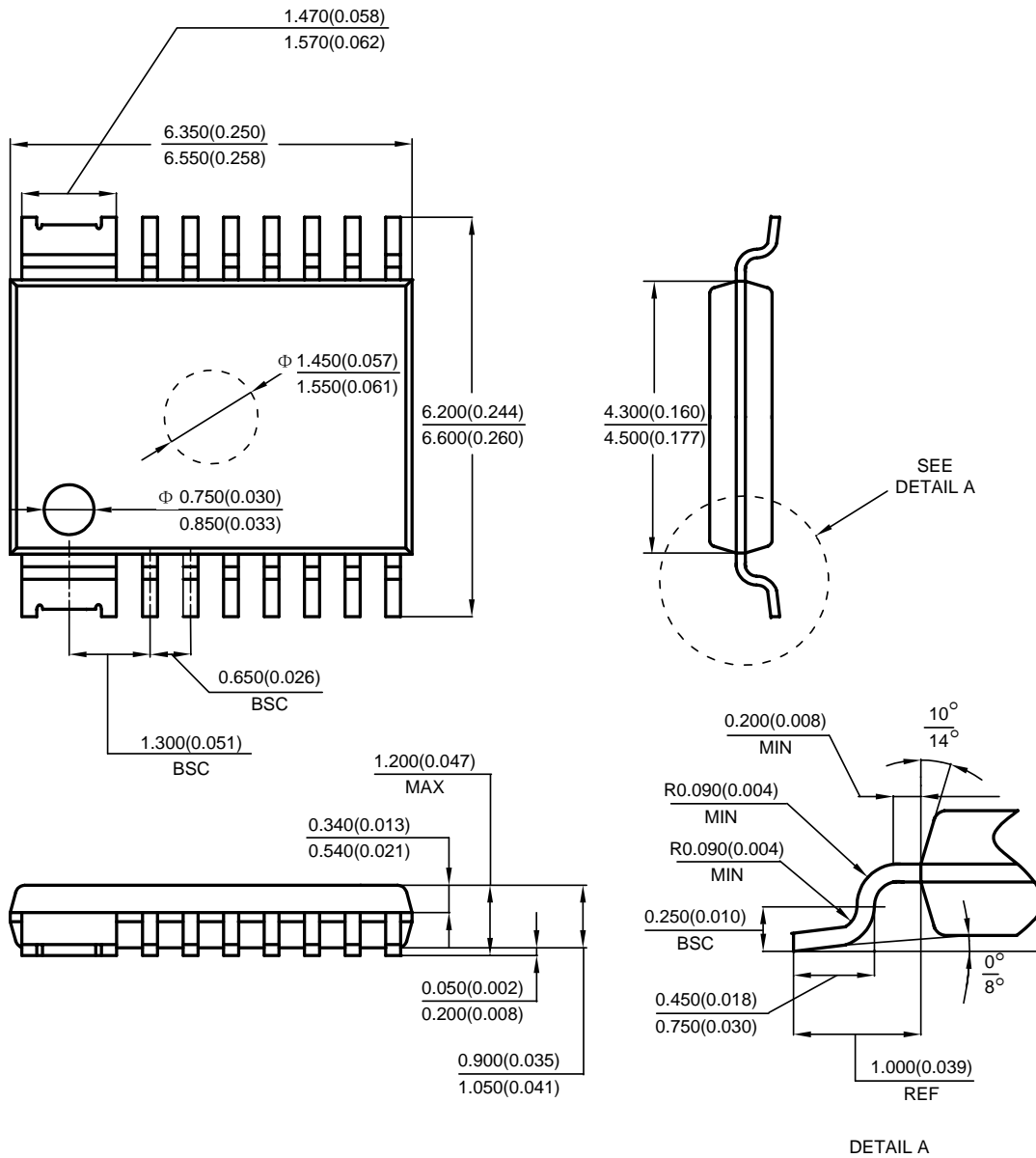



BCD Semiconductor Manufacturing Limited

<http://www.bcdsemi.com>

IMPORTANT NOTICE

BCD Semiconductor Manufacturing Limited reserves the right to make changes without further notice to any products or specifications herein. BCD Semiconductor Manufacturing Limited does not assume any responsibility for use of any its products for any particular purpose, nor does BCD Semiconductor Manufacturing Limited assume any liability arising out of the application or use of any its products or circuits. BCD Semiconductor Manufacturing Limited does not convey any license under its patent rights or other rights nor the rights of others.

MAIN SITE

- Headquarters

BCD Semiconductor Manufacturing Limited

No. 1600, Zi Xing Road, Shanghai Zizhu Science-based Industrial Park, 200241, China
Tel: +86-21-24162266, Fax: +86-21-24162277

- Wafer Fab

Shanghai SIM-BCD Semiconductor Manufacturing Co., Ltd.

800 Yi Shan Road, Shanghai 200233, China
Tel: +86-21-6485 1491, Fax: +86-21-5450 0008

REGIONAL SALES OFFICE

Shenzhen Office

Shanghai SIM-BCD Semiconductor Manufacturing Co., Ltd., Shenzhen Office
Room E, 5F, Noble Center, No.1006, 3rd Fuzhong Road, Futian District, Shenzhen,
518026, China
Tel: +86-755-8826 7951
Fax: +86-755-8826 7865

Taiwan Office

BCD Semiconductor (Taiwan) Company Limited
4F, 298-1, Rui Guang Road, Nei-Hu District, Taipei,
Taiwan
Tel: +886-2-2656 2808
Fax: +886-2-2656 2806

USA Office

BCD Semiconductor Corp.
30920 Huntwood Ave. Hayward,
CA 94544, USA
Tel : +1-510-324-2988
Fax: +1-510-324-2788

Данный компонент на территории Российской Федерации

Вы можете приобрести в компании MosChip.

Для оперативного оформления запроса Вам необходимо перейти по данной ссылке:

<http://moschip.ru/get-element>

Вы можете разместить у нас заказ для любого Вашего проекта, будь то серийное производство или разработка единичного прибора.

В нашем ассортименте представлены ведущие мировые производители активных и пассивных электронных компонентов.

Нашей специализацией является поставка электронной компонентной базы двойного назначения, продукции таких производителей как XILINX, Intel (ex.ALTERA), Vicor, Microchip, Texas Instruments, Analog Devices, Mini-Circuits, Amphenol, Glenair.

Сотрудничество с глобальными дистрибьюторами электронных компонентов, предоставляет возможность заказывать и получать с международных складов практически любой перечень компонентов в оптимальные для Вас сроки.

На всех этапах разработки и производства наши партнеры могут получить квалифицированную поддержку опытных инженеров.

Система менеджмента качества компании отвечает требованиям в соответствии с ГОСТ Р ИСО 9001, ГОСТ РВ 0015-002 и ЭС РД 009

Офис по работе с юридическими лицами:

105318, г.Москва, ул.Щербаковская д.3, офис 1107, 1118, ДЦ «Щербаковский»

Телефон: +7 495 668-12-70 (многоканальный)

Факс: +7 495 668-12-70 (доб.304)

E-mail: info@moschip.ru

Skype отдела продаж:

moschip.ru

moschip.ru_4

moschip.ru_6

moschip.ru_9