

Solid-state Timer H3JA

Economical, Compact, Plug-in Timer

- Time limit, ON-delay, operation with automatic resetting.
- DIN size (36 x 36 mm), fits standard 8-pin sockets.
- Wide choice of supply voltages:
24, 100 to 120, 200 to 240 VAC, 12, 24 VDC.
- Dual LED indication for power and output status.
- Large transparent setting knob.
- Setting error rating almost matches that of a 48 x 48 timer.
- Conforms to UL and CSA, and meets CE marking requirements.



Ordering Information

Stock Note: Shaded models are normally stocked.

Operation/resetting system	Time-limit contact	Mounting method	Rated time	Model
Time-limit operation/ self-resetting	SPDT	Surface mounting, flush mounting, and DIN track mounting	1 s, 3 s, 5 s, 10 s, 30 s, 60 s, 3 min, 5 min, 10 min, 30 min, 60 min, 3 hrs	H3JA-8A
	DPDT		1 s, 3 s, 5 s, 10 s, 30 s, 60 s, 3 min, 5 min, 10 min, 30 min, 60 min, 3 hrs	H3JA-8C

Note: Specify the model number, supply voltage, and rated time when ordering.

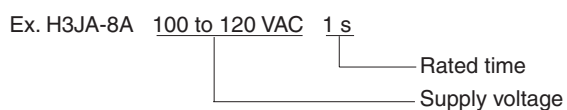

■ Accessories (Order Separately)

Stock Note: Shaded models are normally stocked.

Name/specifications		Model
Flush mounting adapter		Y92F-31
Mounting track	50 cm (l) x 7.3 mm (t)	PFP-50N
	1 m (l) x 7.3 mm (t)	PFP-100N
	1 m (l) x 16 mm (t)	PFP-100N2
End plate		PFP-M
Spacer		PFP-S
Track mounting/ Front connecting socket	8-pin	PF085A
Back connecting socket	8-pin	P3G-08
	8-pin, finger safe type	P3G-08 with Y92A-48G (see note 1)
Hold-down clip (see note 2)	For PF085A Socket	Y92H-6

Note: 1. Y92A-48G is a finger safe terminal cover which is attached to the P3G-08 Socket.

2. Hold-down Clips are sold in sets of two.

Specifications

■ Time Ranges

Rated time	Time range	Rated time	Time range
1 s	0.1 to 1 s	3 min	0.3 to 3 min
3 s	0.3 to 3 s	5 min	0.5 to 5 min
5 s	0.5 to 5 s	10 min	1 to 10 min
10 s	1 to 10 s	30 min	3 to 30 min
30 s	3 to 30 s	60 min	6 to 60 min
60 s	6 to 60 s	3 hrs	0.3 to 3 hrs

■ Ratings

Rated supply voltage	24, 100 to 120 or 200 to 240 VAC (50/60 Hz); 24 VDC; 12 VDC (only available on H3JA-8A model)
Operating voltage range	85% to 110% of rated supply voltage
Power consumption	<p><u>H3JA-8A</u> 100 to 120 VAC: Approx. 3 VA (1.3 W) at 120 VAC 200 to 240 VAC: Approx. 5 VA (1.5 W) at 240 VAC 24 VAC: Approx. 1.2 VA (0.9 W) at 24 VAC 24 VDC: Approx. 0.8 W at 24 VDC</p> <p><u>H3JA-8C</u> 100 to 120 VAC: Approx. 3 VA (1.1 W) at 120 VAC 200 to 240 VAC: Approx. 5 VA (1.3 W) at 240 VAC 24 VAC: Approx. 1.3 VA (1 W) at 24 VAC 24 VDC: Approx. 0.9 W at 24 VDC</p>
Control outputs	H3JA-8A: 7 A at 250 VAC, resistive load H3JA-8C: 5 A at 250 VAC, resistive load

■ Characteristics

Accuracy of operating time	±2% max.
Setting error	±7% max.
Influence of voltage	±2% max.
Influence of temperature	±5% max.
Insulation resistance	100 MΩ min. (at 500 VDC)
Dielectric strength	2,000 VAC, 50/60 Hz for 1 min (between current-carrying and non-current-carrying parts, and between contact-carrying and control circuit, and between contacts of different poles) 1,000 VAC, 50/60 Hz for 1 min (between non-continuous contacts)
Impulse withstand voltage	3 kV (between power terminals) 4.5 kV (between current-carrying terminal and exposed non-current-carrying metal parts)
Noise immunity	±1.5 kV (between power terminals) and ±1.5 kV (between output terminals), square-wave noise by noise simulator (pulse width: 100 ns/1 μs, 1-ns rise)
Static immunity	Destruction: 8 kV Malfunction: 6 kV
Vibration resistance	Destruction: 10 to 55 Hz with 0.75-mm double amplitude in 3 directions for 1 hour each. Malfunction: 10 to 55 Hz with 0.5-mm double amplitude in 3 directions for 10 minutes each.
Shock resistance	Destruction: 1,000 m/s ² Malfunction: 100 m/s ²
Ambient temperature	Operating: -10°C to 55°C Storage: -25°C to 65°C
Ambient humidity	Operating: 35% to 85%
Life expectancy	<u>H3JA-8A</u> Mechanical: 10,000,000 operations min. Electrical: 60,000 operations min. (7 A resistive load at 250 VAC, 360 operations/h) <u>H3JA-8C</u> Mechanical: 10,000,000 operations min. Electrical: 100,000 operations min. (5 A resistive load at 250 VAC, 360 operations/h)
EMC	(EMI) Emission Enclosure: EN55011 Group 1 class A Emission AC Mains: EN55011 Group 1 class A (EMS) Immunity ESD: EN61000-4-2: 6 kV contact discharge (level 3) 8 kV air discharge (level 3) Immunity RF-interference from AM Radio Waves: EN61000-4-3: 10 V/m (80 MHz to 1 GHz) (level 3) Immunity Burst: EN61000-4-4: 2 kV power port and output port (level 3) 1 kV control port with capacitive clamp (level 3) Immunity Surge: EN61000-4-5: 2 kV common mode (level 3) 1 kV differential mode (level 3)
Approved standard	UL508, CSA C22.2 No. 14, conforms to EN61812-1
Case color	Light gray (Munsell 5Y7/1)
Degree of protection	IP40 (panel surface)
Weight	H3JA-8A: Approx. 50 g H3JA-8C: Approx. 60 g

Engineering Data

■ H3JA-8A

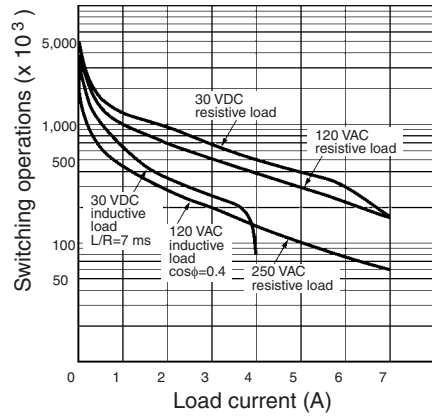

■ H3JA-8C

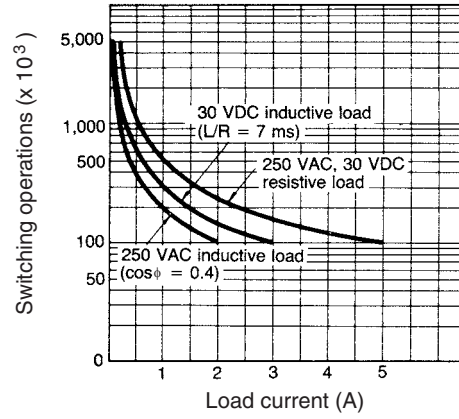

Operation

■ Timing Chart

H3JA-8A

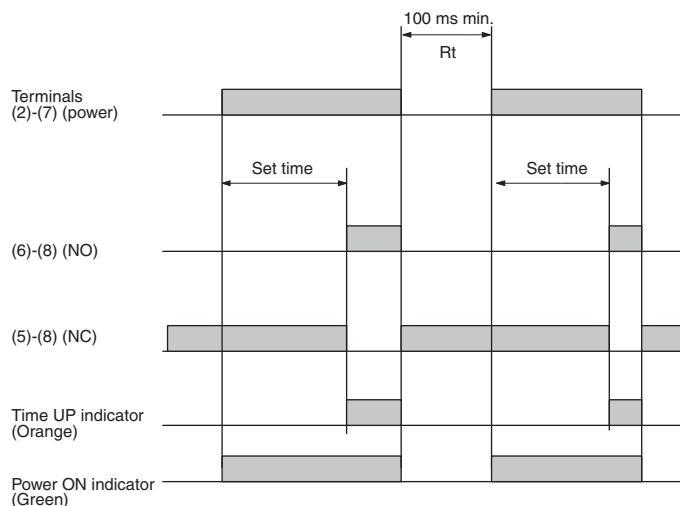

H3JA-8C

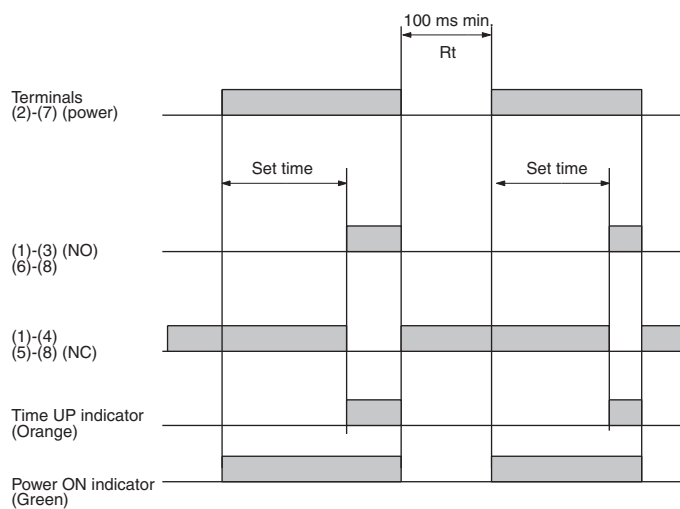

Dimensions

Unit: mm (inch)

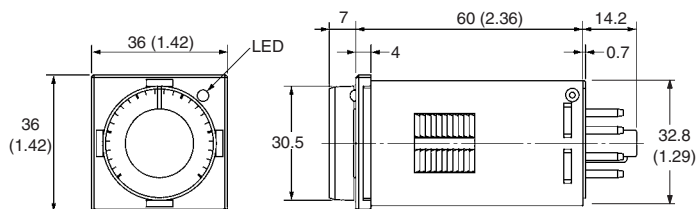
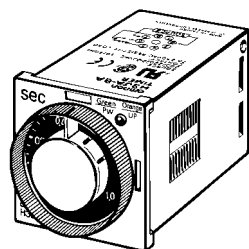

■ Accessories (Order Separately)

Flush Mounting Adapter

Y92F-31

Adapter Y92F-31 shown with H3JA-8□ and back connecting socket.

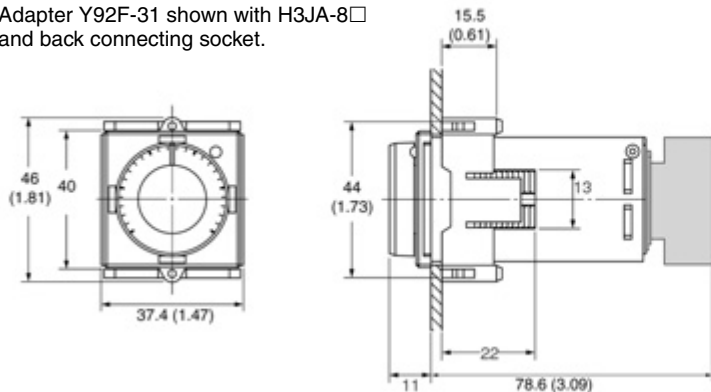

Panel Cutout

Recommended panel thickness: 1 to 5 mm

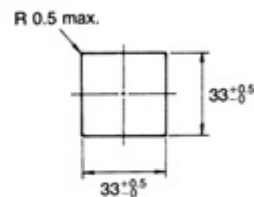

Track Mounting/Front Connecting Socket

PF085A

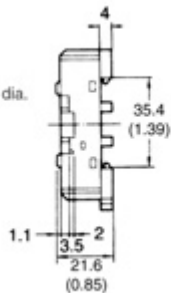
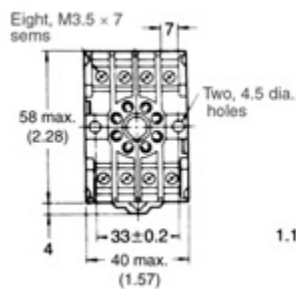

Terminal Arrangement (Top View)

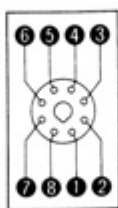

Mounting Holes

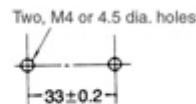

Note: PF085A can be used as a front connecting socket.

Mounting Height of Timer with Socket

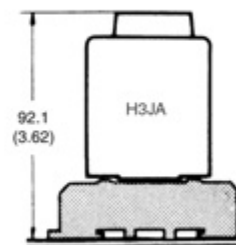

Hold-down Clips (Set of Two Clips)

Y92H-6 for PF085A

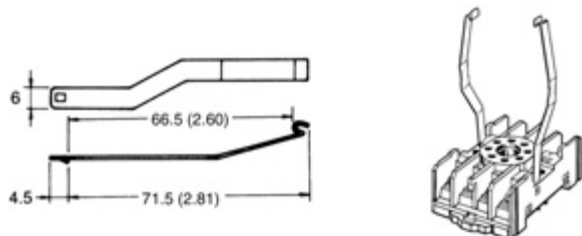

Back Connecting Socket

P3G-08

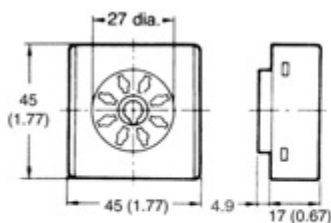

Terminal Arrangement (Bottom View)

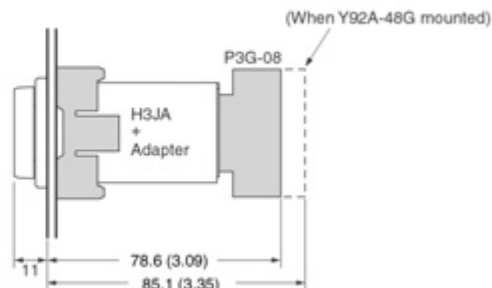
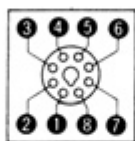

Finger Safe Terminal Cover Conforming to VDe0106/P100

Y92A-48G

(Attachments for P3G-08 Socket)

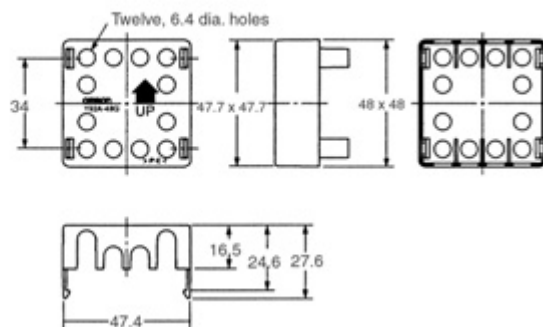
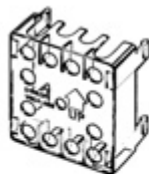

Mounting Track

PFP-100N, PFP-50N

PFP-100N, PFP-50N

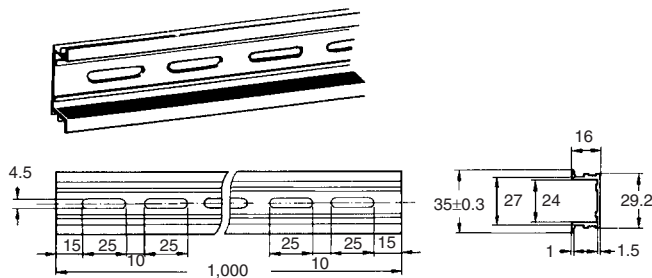
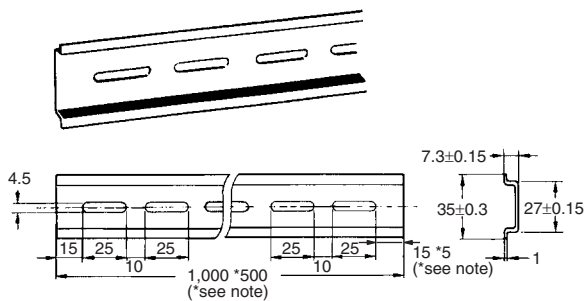

Note: The values shown with an asterisk are for the PFP-50N.

End Plate

PFP-M

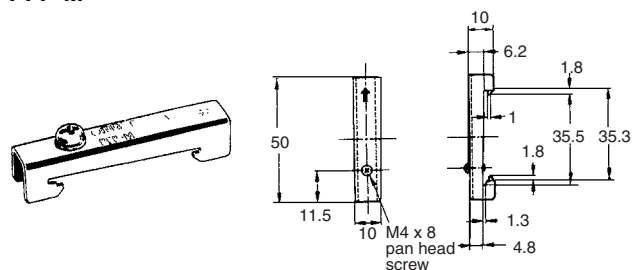

Spacer

PFP-S

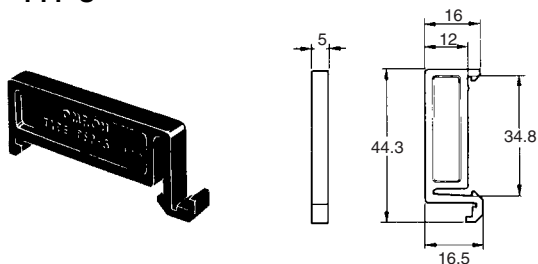

Installation

■ Terminal Arrangement

H3JA-8A

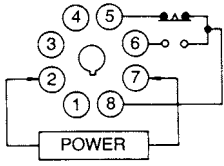

H3JA-8C

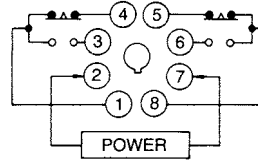

Certain Terms and Conditions of Sale

- Offer; Acceptance.** These terms and conditions (these "Terms") are deemed part of all catalogs, manuals or other documents, whether electronic or in writing, relating to the sale of goods or services (collectively, the "Goods") by Omron Electronics LLC and its subsidiary companies ("Seller"). Seller hereby objects to any terms or conditions proposed in Buyer's purchase order or other documents which are inconsistent with, or in addition to, these Terms. Please contact your Omron representative to confirm any additional terms for sales from your Omron company.
- Prices.** All prices stated are current, subject to change without notice by Seller. Buyer agrees to pay the price in effect at time of shipment.
- Discounts.** Cash discounts, if any, will apply only on the net amount of invoices sent to Buyer after deducting transportation charges, taxes and duties, and will be allowed only if (i) the invoice is paid according to Seller's payment terms and (ii) Buyer has no past due amounts owing to Seller.
- Orders.** Seller will accept no order less than \$200 net billing.
- Governmental Approvals.** Buyer shall be responsible for, and shall bear all costs involved in, obtaining any government approvals required for the importation or sale of the Goods.
- Taxes.** All taxes, duties and other governmental charges (other than general real property and income taxes), including any interest or penalties thereon, imposed directly or indirectly on Seller or required to be collected directly or indirectly by Seller for the manufacture, production, sale, delivery, importation, consumption or use of the Goods sold hereunder (including customs duties and sales, excise, use, turnover and license taxes) shall be charged to and remitted by Buyer to Seller.
- Financial.** If the financial position of Buyer at any time becomes unsatisfactory to Seller, Seller reserves the right to stop shipments or require satisfactory security or payment in advance. If Buyer fails to make payment or otherwise comply with these Terms or any related agreement, Seller may (without liability and in addition to other remedies) cancel any unshipped portion of Goods sold hereunder and stop any Goods in transit until Buyer pays all amounts, including amounts payable hereunder, whether or not then due, which are owing to it by Buyer. Buyer shall in any event remain liable for all unpaid accounts.
- Cancellation; Etc.** Orders are not subject to rescheduling or cancellation unless Buyer indemnifies Seller fully against all costs or expenses arising in connection therewith.
- Force Majeure.** Seller shall not be liable for any delay or failure in delivery resulting from causes beyond its control, including earthquakes, fires, floods, strikes or other labor disputes, shortage of labor or materials, accidents to machinery, acts of sabotage, riots, delay in or lack of transportation or the requirements of any government authority.
- Shipping; Delivery.** Unless otherwise expressly agreed in writing by Seller:
 - Shipments shall be by a carrier selected by Seller;
 - Such carrier shall act as the agent of Buyer and delivery to such carrier shall constitute delivery to Buyer;
 - All sales and shipments of Goods shall be FOB shipping point (unless otherwise stated in writing by Seller), at which point title to and all risk of loss of the Goods shall pass from Seller to Buyer, provided that Seller shall retain a security interest in the Goods until the full purchase price is paid by Buyer;
 - Delivery and shipping dates are estimates only.
 - Seller will package Goods as it deems proper for protection against normal handling and extra charges apply to special conditions.
- Claims.** Any claim by Buyer against Seller for shortage or damage to the Goods occurring before delivery to the carrier must be presented in writing to Seller within 30 days of receipt of shipment and include the original transportation bill signed by the carrier noting that the carrier received the Goods from Seller in the condition claimed.
- Warranties.** (a) **Exclusive Warranty.** Seller's exclusive warranty is that the Goods will be free from defects in materials and workmanship for a period of twelve months from the date of sale by Seller (or such other period expressed in writing by Seller). Seller disclaims all other warranties, express or implied. (b) **Limitations.** SELLER MAKES NO WARRANTY OR REPRESENTATION, EXPRESS OR IMPLIED, ABOUT NON-INFRINGEMENT, MERCHANTABILITY OR FITNESS FOR A PARTICULAR PURPOSE OF THE GOODS. BUYER ACKNOWLEDGES THAT IT ALONE HAS DETERMINED THAT THE GOODS WILL SUITABLY MEET THE REQUIREMENTS OF THEIR INTENDED USE. Seller further disclaims all warranties and responsibility of any type for claims or expenses based on infringement by the Goods or otherwise of any intellectual property right. (c) **Buyer Remedy.** Seller's sole obligation hereunder shall be to replace (in the form originally shipped with Buyer responsible for labor charges for removal or replacement thereof) the non-complying Good or, at Seller's election, to repay or credit Buyer an amount equal to the purchase price of the Good; provided that in no event shall Seller be responsible for warranty, repair, indemnity or any other claims or expenses regarding the Goods unless Seller's analysis confirms that the Goods were properly handled, stored, installed and maintained and not subject to contamination, abuse, misuse or inappropriate modification. Return of any goods by Buyer must be approved in writing by Seller before shipment. Seller shall not be liable for the suitability or unsuitability or the results from the use of Goods in combination with any electrical or electronic components, circuits, system assemblies or any other materials or substances or environments. Any advice, recommendations or information given orally or in writing, are not to be construed as an amendment or addition to the above warranty.
- Damage Limits; Etc.** SELLER SHALL NOT BE LIABLE FOR SPECIAL, INDIRECT OR CONSEQUENTIAL DAMAGES, LOSS OF PROFITS OR PRODUCTION OR COMMERCIAL LOSS IN ANY WAY CONNECTED WITH THE GOODS, WHETHER SUCH CLAIM IS BASED IN CONTRACT, WARRANTY, NEGLIGENCE OR STRICT LIABILITY. Further, in no event shall liability of Seller exceed the individual price of the Good on which liability is asserted.
- Indemnities.** Buyer shall indemnify and hold harmless Seller, its affiliates and its employees from and against all liabilities, losses, claims, costs and expenses (including attorney's fees and expenses) related to any claim, investigation, litigation or proceeding (whether or not Seller is a party) which arises or is alleged to arise from Buyer's acts or omissions under these Terms or in any way with respect to the Goods. Without limiting the foregoing, Buyer (at its own expense) shall indemnify and hold harmless Seller and defend or settle any action brought against Seller to the extent that it is based on a claim that any Good made to Buyer specifications infringed intellectual property rights of another party.
- Property; Confidentiality.** The intellectual property embodied in the Goods is the exclusive property of Seller and its affiliates and Buyer shall not attempt to duplicate it in any way without the written permission of Seller. Notwithstanding any charges to Buyer for engineering or tooling, all engineering and tooling shall remain the exclusive property of Seller. All information and materials supplied by Seller to Buyer relating to the Goods are confidential and proprietary, and Buyer shall limit distribution thereof to its trusted employees and strictly prevent disclosure to any third party.
- Miscellaneous.** (a) **Waiver.** No failure or delay by Seller in exercising any right and no course of dealing between Buyer and Seller shall operate as a waiver of rights by Seller. (b) **Assignment.** Buyer may not assign its rights hereunder without Seller's written consent. (c) **Amendment.** These Terms constitute the entire agreement between Buyer and Seller relating to the Goods, and no provision may be changed or waived unless in writing signed by the parties. (d) **Severability.** If any provision hereof is rendered ineffective or invalid, such provision shall not invalidate any other provision. (e) **Setoff.** Buyer shall have no right to set off any amounts against the amount owing in respect of this invoice. (f) As used herein, "including" means "including without limitation".

Certain Precautions on Specifications and Use

- Suitability of Use.** Seller shall not be responsible for conformity with any standards, codes or regulations which apply to the combination of the Good in the Buyer's application or use of the Good. At Buyer's request, Seller will provide applicable third party certification documents identifying ratings and limitations of use which apply to the Good. This information by itself is not sufficient for a complete determination of the suitability of the Good in combination with the end product, machine, system, or other application or use. The following are some examples of applications for which particular attention must be given. This is not intended to be an exhaustive list of all possible uses of this Good, nor is it intended to imply that the uses listed may be suitable for this Good:
 - Outdoor use, uses involving potential chemical contamination or electrical interference, or conditions or uses not described in this document.
 - Energy control systems, combustion systems, railroad systems, aviation systems, medical equipment, amusement machines, vehicles, safety equipment, and installations subject to separate industry or government regulations.
 - Systems, machines and equipment that could present a risk to life or property. Please know and observe all prohibitions of use applicable to this Good.

NEVER USE THE PRODUCT FOR AN APPLICATION INVOLVING SERIOUS RISK TO LIFE OR PROPERTY WITHOUT ENSURING THAT THE SYSTEM AS A WHOLE HAS BEEN DESIGNED TO ADDRESS THE RISKS, AND THAT THE SELLER'S PRODUCT IS PROPERLY RATED AND INSTALLED FOR THE INTENDED USE WITHIN THE OVERALL EQUIPMENT OR SYSTEM.
- Programmable Products.** Seller shall not be responsible for the user's programming of a programmable Good, or any consequence thereof.
- Performance Data.** Performance data given in this catalog is provided as a guide for the user in determining suitability and does not constitute a warranty. It may represent the result of Seller's test conditions, and the user must correlate it to actual application requirements. Actual performance is subject to the Seller's Warranty and Limitations of Liability.
- Change in Specifications.** Product specifications and accessories may be changed at any time based on improvements and other reasons. It is our practice to change part numbers when published ratings or features are changed, or when significant construction changes are made. However, some specifications of the Good may be changed without any notice. When in doubt, special part numbers may be assigned to fix or establish key specifications for your application. Please consult with your Seller's representative at any time to confirm actual specifications of purchased Good.
- Errors and Omissions.** The information in this catalog has been carefully checked and is believed to be accurate; however, no responsibility is assumed for clerical, typographical or proofreading errors, or omissions.

Complete "Terms and Conditions of Sale" for product purchase and use are on Omron's website at www.omron.com/oei – under the "About Us" tab, in the Legal Matters section.

ALL DIMENSIONS SHOWN ARE IN MILLIMETERS.

To convert millimeters into inches, multiply by 0.03937. To convert grams into ounces, multiply by 0.03527.

OMRON.**OMRON ELECTRONICS LLC**

One Commerce Drive
Schaumburg, IL 60173

847-843-7900

For US technical support or other inquiries:

800-556-6766**OMRON CANADA, INC.**

885 Milner Avenue
Toronto, Ontario M1B 5V8

416-286-6465**OMRON ON-LINE**

Global - <http://www.omron.com>
USA - <http://www.omron.com/oei>
Canada - <http://www.omron.ca>

Данный компонент на территории Российской Федерации

Вы можете приобрести в компании MosChip.

Для оперативного оформления запроса Вам необходимо перейти по данной ссылке:

<http://moschip.ru/get-element>

Вы можете разместить у нас заказ для любого Вашего проекта, будь то серийное производство или разработка единичного прибора.

В нашем ассортименте представлены ведущие мировые производители активных и пассивных электронных компонентов.

Нашей специализацией является поставка электронной компонентной базы двойного назначения, продукции таких производителей как XILINX, Intel (ex.ALTERA), Vicor, Microchip, Texas Instruments, Analog Devices, Mini-Circuits, Amphenol, Glenair.

Сотрудничество с глобальными дистрибьюторами электронных компонентов, предоставляет возможность заказывать и получать с международных складов практически любой перечень компонентов в оптимальные для Вас сроки.

На всех этапах разработки и производства наши партнеры могут получить квалифицированную поддержку опытных инженеров.

Система менеджмента качества компании отвечает требованиям в соответствии с ГОСТ Р ИСО 9001, ГОСТ РВ 0015-002 и ЭС РД 009

Офис по работе с юридическими лицами:

105318, г.Москва, ул.Щербаковская д.3, офис 1107, 1118, ДЦ «Щербаковский»

Телефон: +7 495 668-12-70 (многоканальный)

Факс: +7 495 668-12-70 (доб.304)

E-mail: info@moschip.ru

Skype отдела продаж:

moschip.ru

moschip.ru_4

moschip.ru_6

moschip.ru_9