

FLARE-MAXI-D

34 x 33 mm lens with ~110° x 15° diffused oval beam

TECHNICAL SPECIFICATIONS:

Dimensions	33.9 x 33.3 mm
Height	16.5 mm
Fastening	glue, pin
ROHS compliant	yes ⓘ

MATERIAL SPECIFICATIONS:

Component	Type	Material	Colour	Finish
FLARE-MAXI-D	Single lens	PMMA	clear	



ORDERING INFORMATION:

Component	Qty in box	MOQ	MPQ	Box weight (kg)
C13012_FLARE-MAXI-D » Box size: 451 x 254 x 197 mm	840		168	9.7

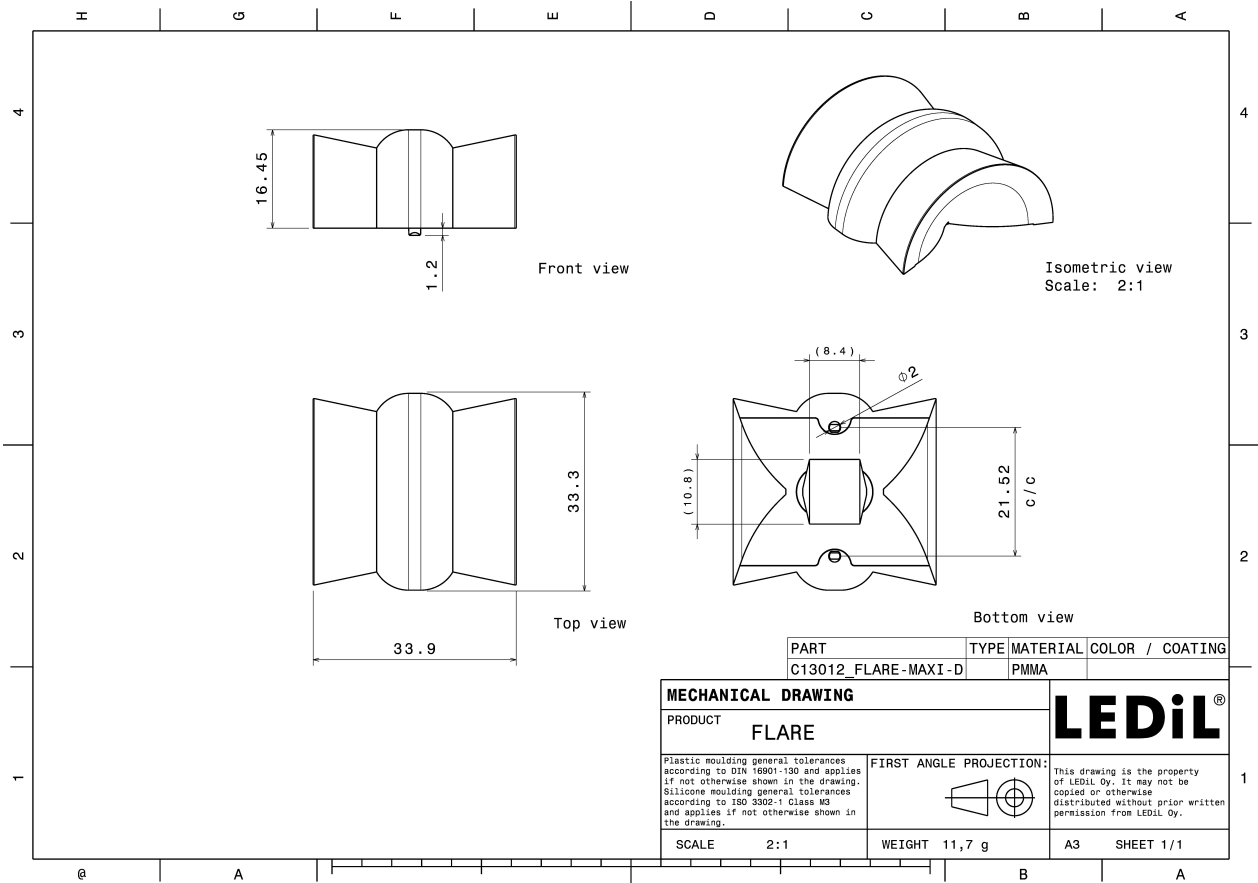

PHOTOMETRIC DATA (MEASURED):

CREE

LED MK-R
 FWHM 100.0 + 23.0°
 Efficiency 92 %
 Peak intensity 1.200 cd/lm
 LEDs/each optic 1
 Light colour White
 Required components:

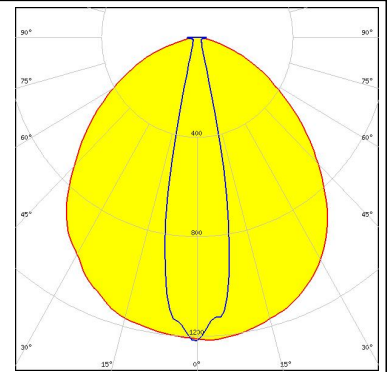

CREE

LED XHP50
 FWHM 104.0 + 19.0°
 Efficiency 92 %
 Peak intensity 1.300 cd/lm
 LEDs/each optic 1
 Light colour White
 Required components:

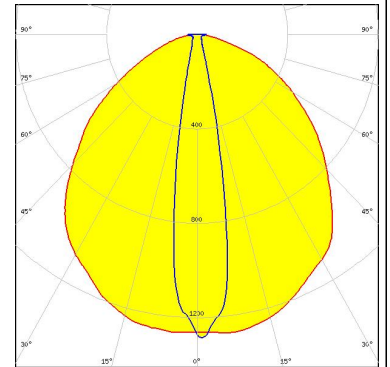
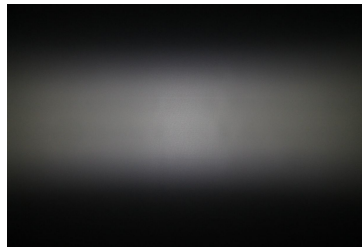

CREE

LED XHP70
 FWHM 104.0 + 28.0°
 Efficiency 92 %
 Peak intensity 0.940 cd/lm
 LEDs/each optic 1
 Light colour White
 Required components:

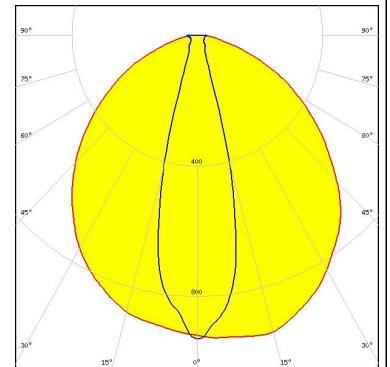
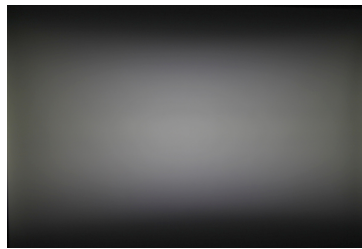

CREE

LED XM-L
 FWHM 110.0 + 15.0°
 Efficiency 94 %
 Peak intensity 1.700 cd/lm
 LEDs/each optic 1
 Light colour White
 Required components:

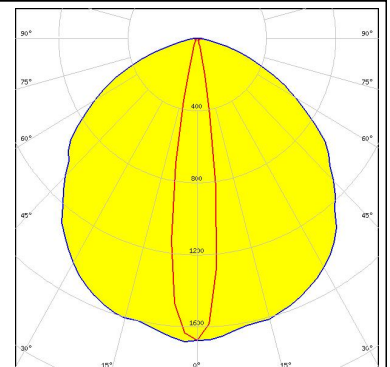

PHOTOMETRIC DATA (MEASURED):



LED XM-L2
 FWHM 101.0 + 17.0°
 Efficiency 94 %
 Peak intensity 1.900 cd/lm
 LEDs/each optic 1
 Light colour White
 Required components:

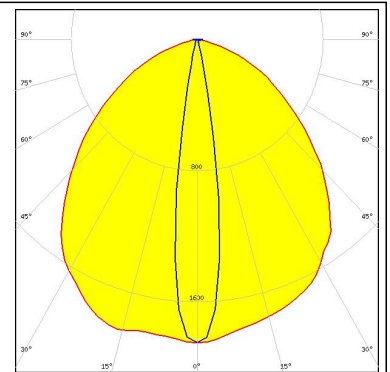

LED XP-G
 FWHM 115.0 + 15.0°
 Efficiency 94 %
 Peak intensity 1.900 cd/lm
 LEDs/each optic 1
 Light colour White
 Required components:

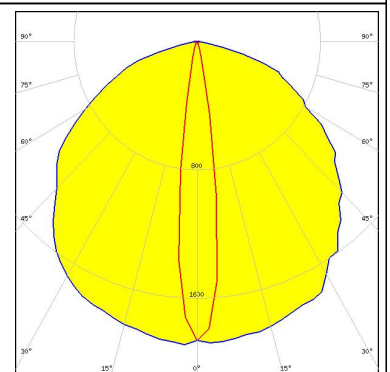

LED XP-G2
 FWHM 106.0 + 14.0°
 Efficiency 94 %
 Peak intensity 2.000 cd/lm
 LEDs/each optic 1
 Light colour White
 Required components:

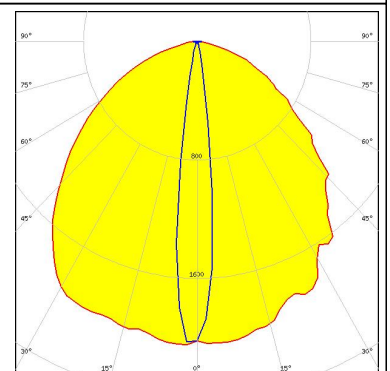

LED XP-L HD
 FWHM 119.0 + 16.0°
 Efficiency 94 %
 Peak intensity 1.480 cd/lm
 LEDs/each optic 1
 Light colour White
 Required components:

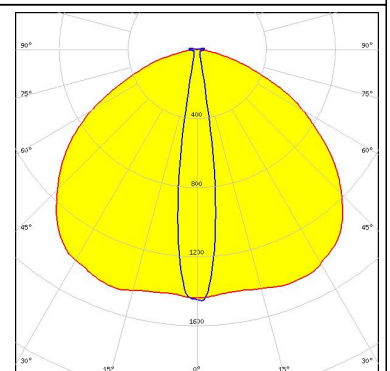
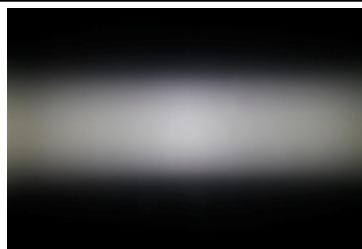

PHOTOMETRIC DATA (MEASURED):



LED XP-L2
 FWHM 107.0 + 16.0°
 Efficiency 94 %
 Peak intensity 1.500 cd/lm
 LEDs/each optic 1
 Light colour White
 Required components:

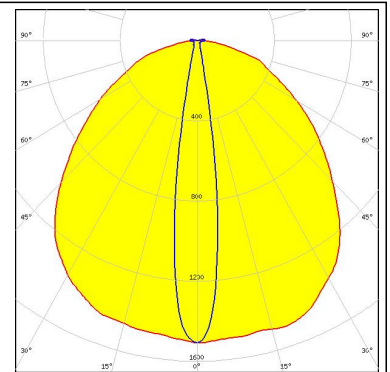
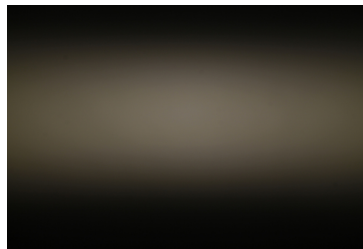

LED XT-E
 FWHM 117.0 + 14.0°
 Efficiency 94 %
 Peak intensity 1.900 cd/lm
 LEDs/each optic 1
 Light colour White
 Required components:

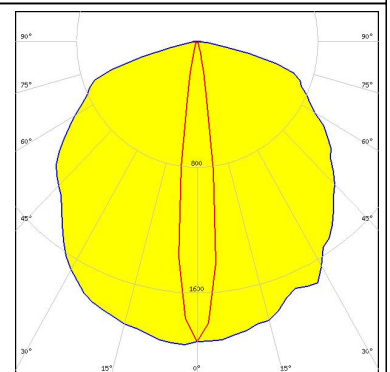

LED LUXEON A
 FWHM 104.0 + 12.0°
 Efficiency 94 %
 Peak intensity 2.100 cd/lm
 LEDs/each optic 1
 Light colour White
 Required components:

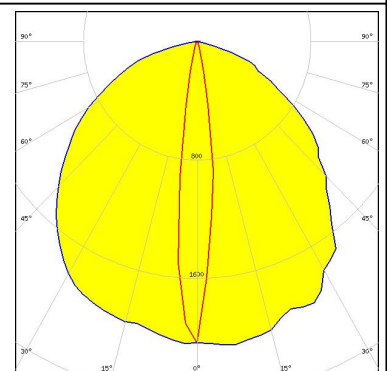

LED LUXEON M/MX
 FWHM 102.0 + 25.0°
 Efficiency 94 %
 Peak intensity 1.400 cd/lm
 LEDs/each optic 1
 Light colour White
 Required components:

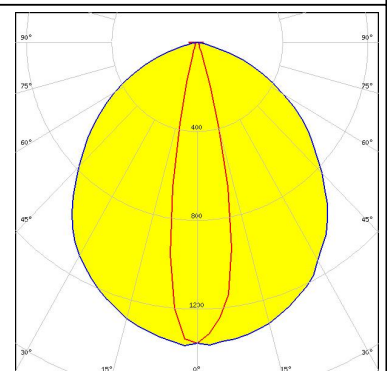
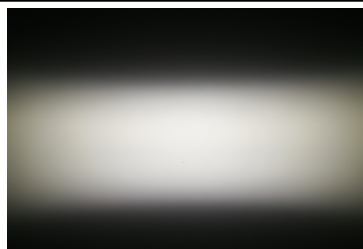

PHOTOMETRIC DATA (MEASURED):

LUMILEDS

LED LUXEON MZ
 FWHM 101.0 + 16.0°
 Efficiency 94 %
 Peak intensity 1.900 cd/lm
 LEDs/each optic 1
 Light colour White
 Required components:

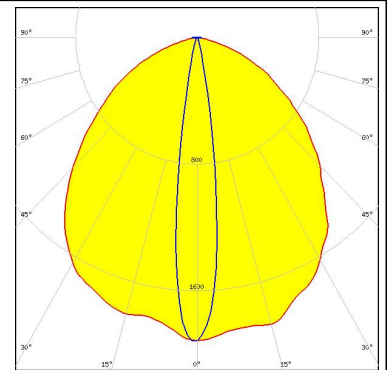

LUMILEDS

LED LUXEON Rebel ES
 FWHM 104.0 + 13.0°
 Efficiency 94 %
 Peak intensity 2.000 cd/lm
 LEDs/each optic 1
 Light colour White
 Required components:

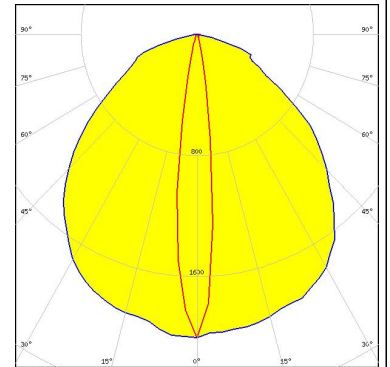

LUMILEDS

LED LUXEON T
 FWHM 102.0 + 13.0°
 Efficiency 92 %
 Peak intensity 1.800 cd/lm
 LEDs/each optic 1
 Light colour White
 Required components:

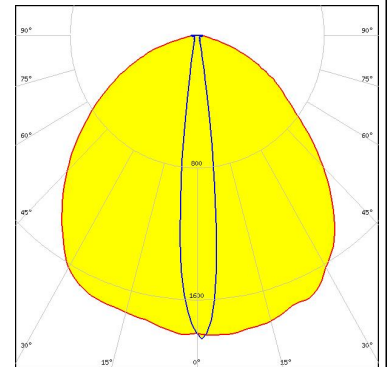

LUMILEDS

LED LUXEON TX
 FWHM 103.0 + 13.0°
 Efficiency 93 %
 Peak intensity 2.060 cd/lm
 LEDs/each optic 1
 Light colour White
 Required components:

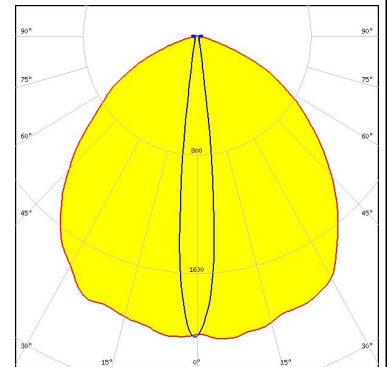
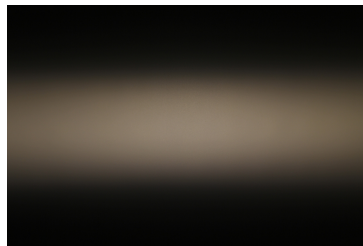

PHOTOMETRIC DATA (MEASURED):



LED NCSxx19B
 FWHM 107.0 + 13.0°
 Efficiency 94 %
 Peak intensity 2.100 cd/lm
 LEDs/each optic 1
 Light colour White
 Required components:

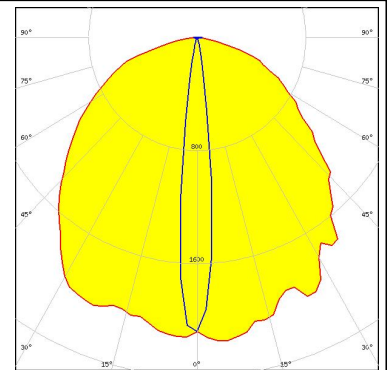

LED NS9x383
 FWHM 110.0 + 16.0°
 Efficiency 93 %
 Peak intensity 1.500 cd/lm
 LEDs/each optic 1
 Light colour White
 Required components:

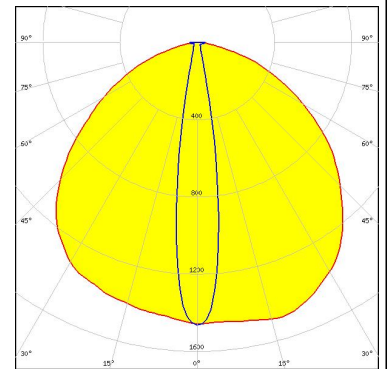

LED NV4x144A
 FWHM 111.0 + 20.0°
 Efficiency 89 %
 Peak intensity 0.600 cd/lm
 LEDs/each optic 1
 Light colour White
 Required components:

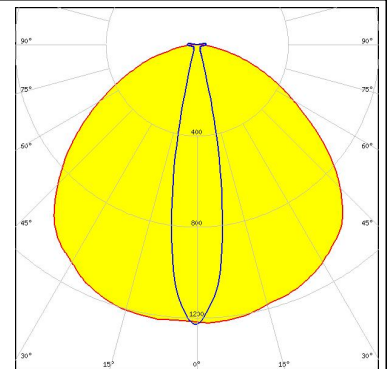

LED NVSW219F
 FWHM 109.0 + 14.0°
 Efficiency 94 %
 Peak intensity 1.900 cd/lm
 LEDs/each optic 1
 Light colour White
 Required components:

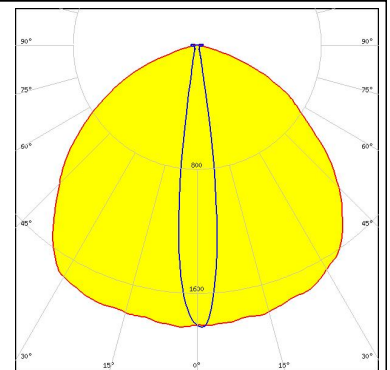
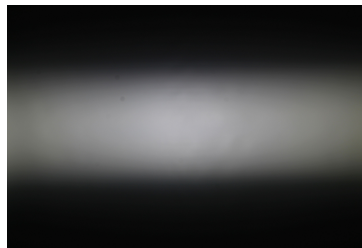

PHOTOMETRIC DATA (MEASURED):



LED NVSxx19B/NVSxx19C
FWHM 116.0 + 13.0°
Efficiency 94 %
Peak intensity 1.700 cd/lm
LEDs/each optic 1
Light colour White
Required components:

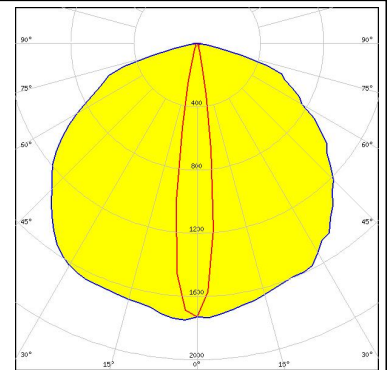

LED NWSx229A
FWHM 117.0 + 15.0°
Efficiency 92 %
Peak intensity 1.600 cd/lm
LEDs/each optic 1
Light colour White
Required components:

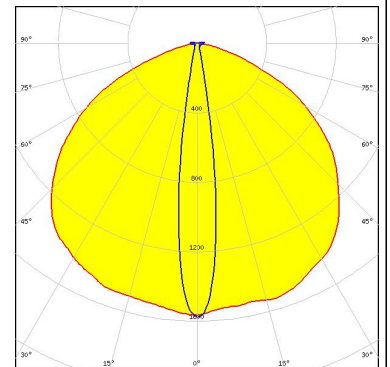
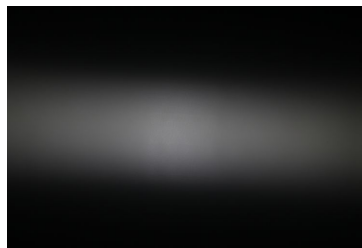

LED Duris S10
FWHM 92.0 + 20.0°
Efficiency 93 %
Peak intensity 1.600 cd/lm
LEDs/each optic 1
Light colour White
Required components:

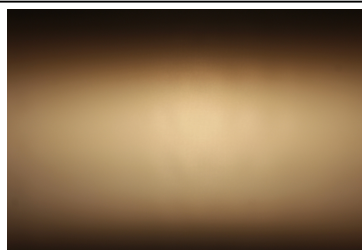

LED OSLON Square EC
FWHM 99.0 + 14.0°
Efficiency 94 %
Peak intensity 2.000 cd/lm
LEDs/each optic 1
Light colour White
Required components:

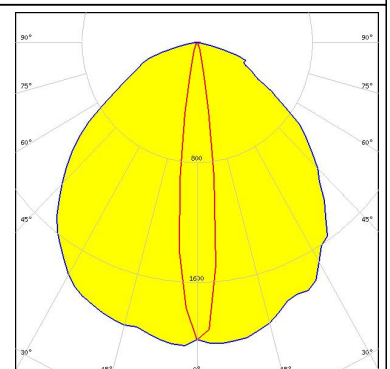

PHOTOMETRIC DATA (MEASURED):

OSRAM

Opto Semiconductors

LED OSLON Square PC
 FWHM 104.0 + 12.0°
 Efficiency 94 %
 Peak intensity 2.000 cd/lm
 LEDs/each optic 1
 Light colour White
 Required components:

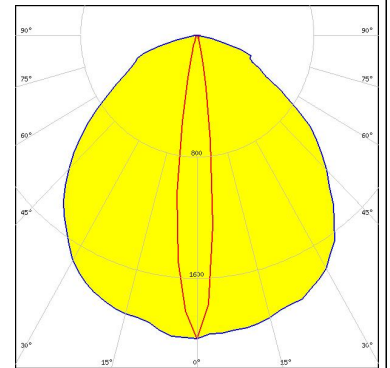

OSRAM

Opto Semiconductors

LED OSLON SSL 150
 FWHM 128.0 + 13.0°
 Efficiency 94 %
 Peak intensity 2.000 cd/lm
 LEDs/each optic 1
 Light colour White
 Required components:

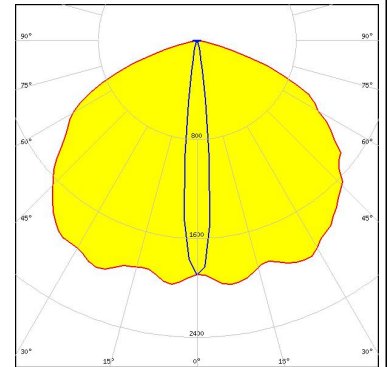
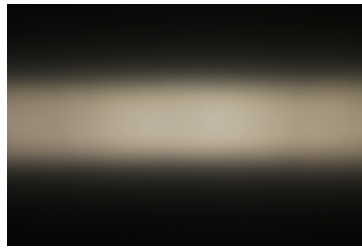

SAMSUNG

LED LH351Z
 FWHM 98.0 + 13.0°
 Efficiency 94 %
 Peak intensity 2.200 cd/lm
 LEDs/each optic 1
 Light colour White
 Required components:

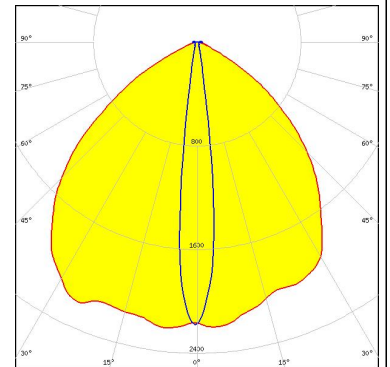
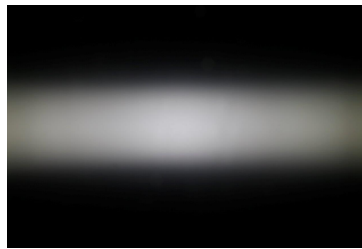

SEOUL SEMICONDUCTOR

LED Z5M1/Z5M2
 FWHM 104.0 + 14.0°
 Efficiency 94 %
 Peak intensity 2.100 cd/lm
 LEDs/each optic 1
 Light colour White
 Required components:

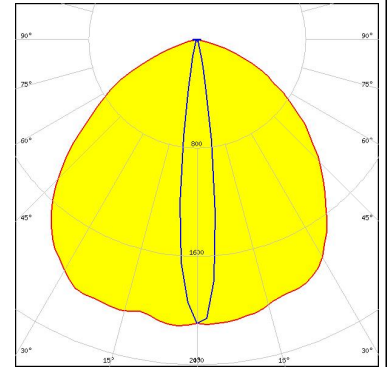
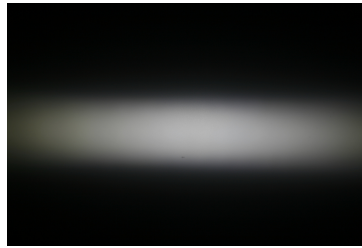

PHOTOMETRIC DATA (MEASURED):

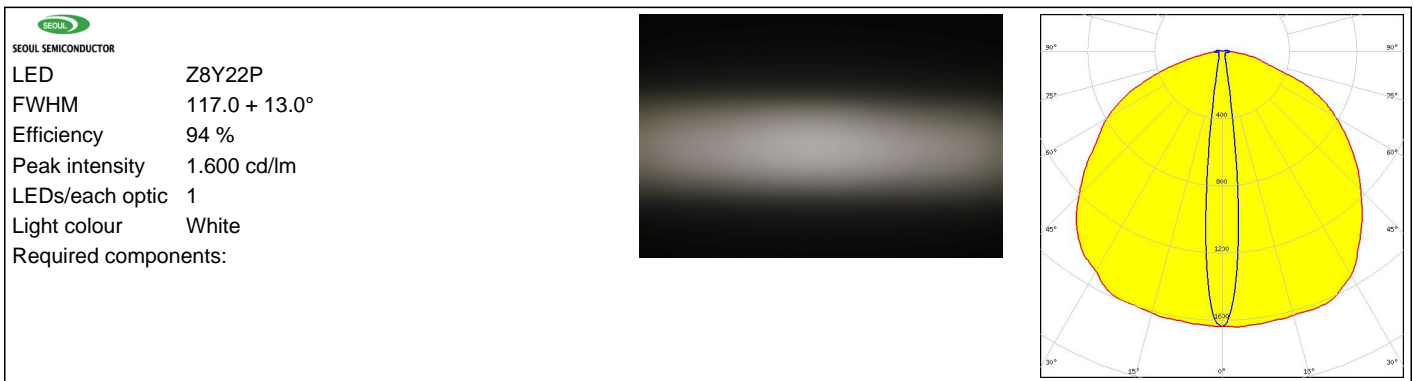

PHOTOMETRIC DATA (SIMULATED):



LED XHP50.2
FWHM 92.0 + 20.0°
Efficiency 94 %
Peak intensity 1.530 cd/lm
LEDs/each optic 1
Light colour White
Required components:

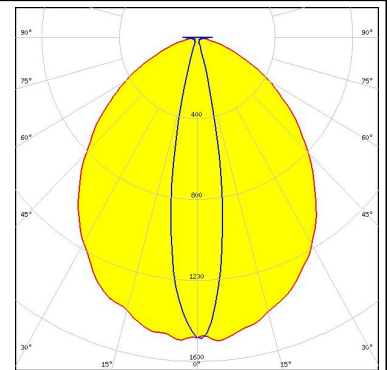

LED XP-G2 HE
FWHM 84.0 + 13.0°
Efficiency 95 %
Peak intensity 2.311 cd/lm
LEDs/each optic 1
Light colour White
Required components:

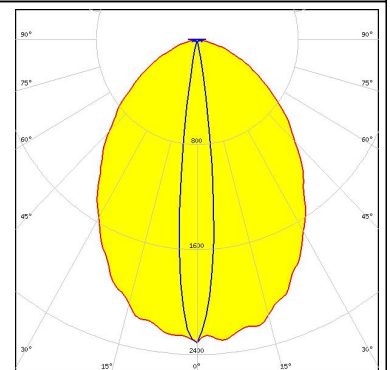

LED LUXEON H50-2
FWHM 10.0 + 65.0°
Efficiency 92 %
Peak intensity 3.300 cd/lm
LEDs/each optic 1
Light colour White
Required components:

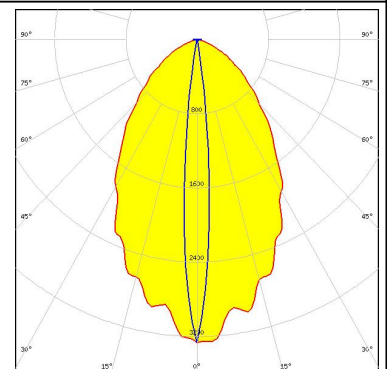

LED OSCONIQ P 7070
FWHM 86.0 + 18.0°
Efficiency 92 %
Peak intensity 1.740 cd/lm
LEDs/each optic 1
Light colour White
Required components:

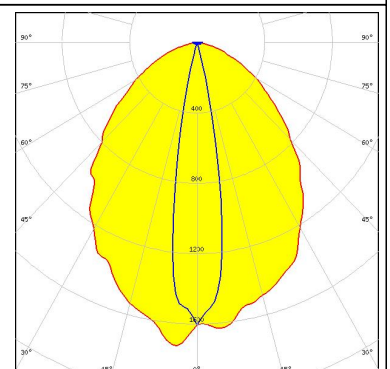
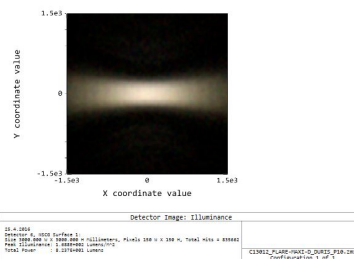

GENERAL INFORMATION:

NOTE: The typical beam angle will be changed by different color, chip size and chip position tolerance. The typical total beam angle is the full angle measured where the luminous intensity is half of the peak value.

MATERIALS:

As part of our continuous research and improvement processes, and to ensure the best possible quality and availability of our products, LEDiL reserves the right to change material grades without notice.

PRODUCT DATA USER AGREEMENT AND DISCLAIMER:

The measured data in the provided downloadable LEDiL Product Datasheets and Mechanical 2D-Drawings is rounded and provided as reference for planning. LEDiL Oy's optical specifications have been verified by conducting performance testing of the products in accordance with the company's quality system. The reported data are averaged results of multiple measurements with typical variation. LEDiL Oy reserves the right to without prior notification make changes and improvements to its products.

LEDiL Oy assumes neither warranty, nor guarantee nor any other liability of any kind for the contents and correctness of the provided data. The provided data has been generated with highest diligence but the provided data may in reality not represent the complete possible variation range of all intrinsic parameters. Therefore, in certain cases a deviation from the provided data could occur.

LEDiL Oy reserves the right to undertake technical changes of its products without further notification which could lead to changes in the provided data. LEDiL Oy assumes no liability of any kind for the possible deviation from any provided data or any other damage resulting from the usage of the provided data.

The user agrees to this disclaimer and user agreement with the download or usage of the provided files.

LEDiL Oy

Joensuunkatu 13
FI-24240 SALO
Finland

LEDiL Inc.

228 West Page Street
Suite D
Sycamore IL 60178
USA

Local sales and technical support

[www.ledil.com/
where_to_buy](http://www.ledil.com/where_to_buy)

Shipping locations

Salo, Finland
Hong Kong, China

Distribution Partners

[www.ledil.com/
where_to_buy](http://www.ledil.com/where_to_buy)

Данный компонент на территории Российской Федерации

Вы можете приобрести в компании MosChip.

Для оперативного оформления запроса Вам необходимо перейти по данной ссылке:

<http://moschip.ru/get-element>

Вы можете разместить у нас заказ для любого Вашего проекта, будь то серийное производство или разработка единичного прибора.

В нашем ассортименте представлены ведущие мировые производители активных и пассивных электронных компонентов.

Нашей специализацией является поставка электронной компонентной базы двойного назначения, продукции таких производителей как XILINX, Intel (ex.ALTERA), Vicor, Microchip, Texas Instruments, Analog Devices, Mini-Circuits, Amphenol, Glenair.

Сотрудничество с глобальными дистрибьюторами электронных компонентов, предоставляет возможность заказывать и получать с международных складов практически любой перечень компонентов в оптимальные для Вас сроки.

На всех этапах разработки и производства наши партнеры могут получить квалифицированную поддержку опытных инженеров.

Система менеджмента качества компании отвечает требованиям в соответствии с ГОСТ Р ИСО 9001, ГОСТ РВ 0015-002 и ЭС РД 009

Офис по работе с юридическими лицами:

105318, г.Москва, ул.Щербаковская д.3, офис 1107, 1118, ДЦ «Щербаковский»

Телефон: +7 495 668-12-70 (многоканальный)

Факс: +7 495 668-12-70 (доб.304)

E-mail: info@moschip.ru

Skype отдела продаж:

moschip.ru

moschip.ru_4

moschip.ru_6

moschip.ru_9