

Product Overview

The QPB8958 is a GaAs pHEMT/MESFET 75-ohm push-pull RF amplifier IC featuring over 34dB of flat gain and low noise. This IC is designed to support applications up to 1003MHz using a single 24V supply. The QPB8958 offers low noise and low distortion at high efficiency consuming only 5.8W in a 5x7 QFN package. Its compact size and low Θ_{jc} enable integration that is ideally suited for hybrid module applications.

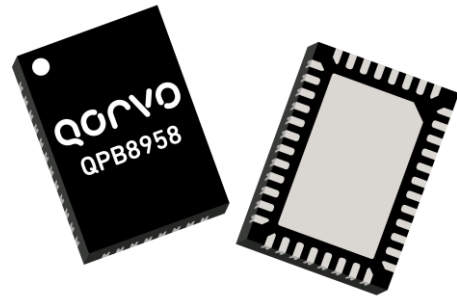

40 pin 5x7 QFN Package

Functional Block Diagram

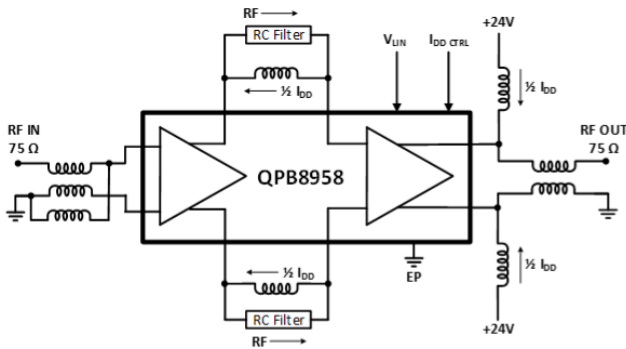

Key Features

- High Gain: 34dB @ 1003MHz
- Adjustable Bias
- 50 - 1003 MHz BW
- 46dBmV/ch flat tilt
- Low Noise: 4.5dB
- Excellent Composite Distortion
- pHEMT / MESFET device technologies
- Compact Size: 40P 5x7 QFN
- Power Consumption (24V, 260mA –5.8W)

Applications

- DOCSIS 3.0
- Broadband CATV hybrid modules
- Head End CMTS Equipment
- 75-ohm amplifiers

Ordering Information

Part No.	Description
QPB8958SB	Sample bag with 5 pieces
QPB8958SR	7" Reel with 100 pieces
QPB8958TR13	13" Reel with 2500 pieces
QPB8958EVB	47 – 1003MHz PCBA

Absolute Maximum Ratings

Parameter	Rating
Supply Voltage (V _{DD})	+28V (5min)
Supply Current (I _{DD})	350mA
Maximum Input Level (single tone)	+10dBmV
Operating Temperature Range	-40 to +100°C
Storage Temperature Range	-65 to +150°C
Maximum Junction Temperature	+165°C

Exceeding any one or a combination of the Absolute Maximum Rating conditions may cause permanent damage to the device. Extended application of Absolute Maximum Rating conditions to the device may reduce device reliability.

Electrical Specifications – 24V

Parameter	Condition ⁽¹⁾	Min	Typ	Max	Unit
Supply Voltage (V _{DD})			24		V
Supply Current (I _{DD})	V _{DD} total current		260		mA
Frequency Range		50		1003	MHz
Gain ²	1003MHz		34		dB
Gain Flatness	Max. deviation from line using least squares fit from 50 to 1003 MHz		±0.5		dB
Gain Slope	Gain(1003MHz) - Gain(50MHz)		1.0		dB
Reverse Isolation			-45		dB
Input Return Loss			18		dB
Output Return Loss			18		dB
Noise Figure			4.5		dB
CSO	80 NTSC + 72 QAM (-6dB offset), 46dBmV/ch out, 0dB tilt		-70		dBc
CTB			-75		dBc
CCN			65		dB
OIP2	Low band: 225MHz, 325MHz, 12dBm/tone		85		dBm
	High band: 900MHz, 950.5MHz, 12dBm/tone		85		dBm
OIP3	Low band: 225MHz, 325MHz, 12dBm/tone		51		dBm
	High band: 900MHz, 325MHz, 12dBm/tone		49		dBm
Output P1dB	1003 MHz		27		dBm
Thermal Resistance	Θ _{JB} (Junction to backside of QFN)		6		°C/W

Notes:

1. Typical performance at these conditions: Temp = +25°C, V_{DD} = +24V, 75Ω system, Full band unless otherwise noted

Evaluation Board Bill of Materials

Reference Designator	Description	Manufacturer	PART #
U1	PCB, QPB8958	Qorvo	QPB8958
C1,C2,C3,C4,C12, C13,C16,C17,C18, C19,C29,C30	CAP, 0.01uF, ±10%, 50V, X7R, 0402	MURATA	GRM155R71H103KA88D
C9,C26,C20,C24	CAP0402, 0.5pF, ±0.1pF, 50V, COG, HIQ	MURATA	GJM1555C1HR50BB01D
C7,C8	CAP, 20pF, 2%, 50V, HI-Q, 0402	MURATA	GJM1555C1H200GB01D
C6, C11	CAP, 470pF, 5%, 50V, COG, 0402	MURATA	GRM1555C1H471JA01D
R3,R4	RES, 15 OHM, 1%, 1/16W, 0402	Kamaya	RMC1/16S-150FTH
R18	RES, 10 OHM, 1%, 1/16W, 0402	Panasonic	ERJ-2RKF10R0X
R19,R11,R12	RES, 0 OHM, 5%, 1/10W, 0402	Kamaya	RMC1/16SJPTH
R33, R34	RES, 200 OHM, 1%, 1/16W, 0402	Panasonic	ERJ-2RKF2000X
R21	RES, 10K, 1%, 1/16W, 0402	Panasonic	ERJ-2RKF1002X
R23	RES, 3K OHM, 1%, 1/10W, 0402, T/F	Panasonic	ERJ-2RKF3001X
R29	RES, 47K, 1%, 1/16W, 0402	Yageo	RCO402FR-0747KL
R31	RES, 6.8K, 1%, 1/10W, 0402	Panasonic	ERJ-2RKF6801X
R27	RES, 22K, 1%, 1/10W, 0402	Panasonic	ERJ-2RKF2202X
R20	RES, 13K, 1%, 1/10W, 0402	Panasonic	ERJ-2RKF1302X
R1,R2	RES, 270 OHM, 5%, 1/16W, 0402	Panasonic	ERJ-2GEJ271
R32,R39	RES, 0 OHM, 0603	Kamaya	RMC1/16JPTP
R36,R37	RES, 1.2K, 5%, 1/16W, 0402	Panasonic	ERJ-2GEJ122
R7,R8	160 OHM,5%,1/16W,0402, LEAD FREE	KOA	RK73B1ETTP161J
L1, L2	IND, 470nH, ±5%, 310mA, 650mHZ, 0402	Coilcraft	0402AF-471XJLW
L9,L14	IND, 2.2nH, +/-0.3nH, M/L, 0402	MURATA	LQG15HN2N2S02D
L3, L4, L7	IND, 8.2nH, 5%, M/L, 0402	MURATA	LQG15HN8N2J02D
L10,L13	IND, 47nH, 5%, M/L, 0402	MURATA	LQG15HN47NJ02D
L5,L6	IND, 3.3nH, +/-0.1nH, T/F, 0402	MURATA	LQP15MN3N3B02D
L8	IND, 1.5nH, +/-0.2nH, T/F, 0402	KOA	KL731ETP1N5C
L16, L17	IND, 2.2uH, 20%, 0.36A, 0.7mm, W/W, 0603	TAIYO YUDEN	BRL1608T2R2M
T1	XFMR, SMT, 75 OHM, CD542, 1:1 BALUN, TC1	Mini Circuits	TC1-33-75G2+
T2	XFMR, 2:1, 5-1200MHz, 75 OHM, 0.25W, SMD	Mini Circuits	TRS2-1T-75+
C10,C21,C22,C23, C25,C27,R15,R16, R17,R24,R26,R30, U2,U3,U4,U5	NO LOAD - 0402		
C28,C31,C32,R22,R25 R28,R35,R38,R40	NO LOAD - 0402		

Evaluation Board Assembly Drawing

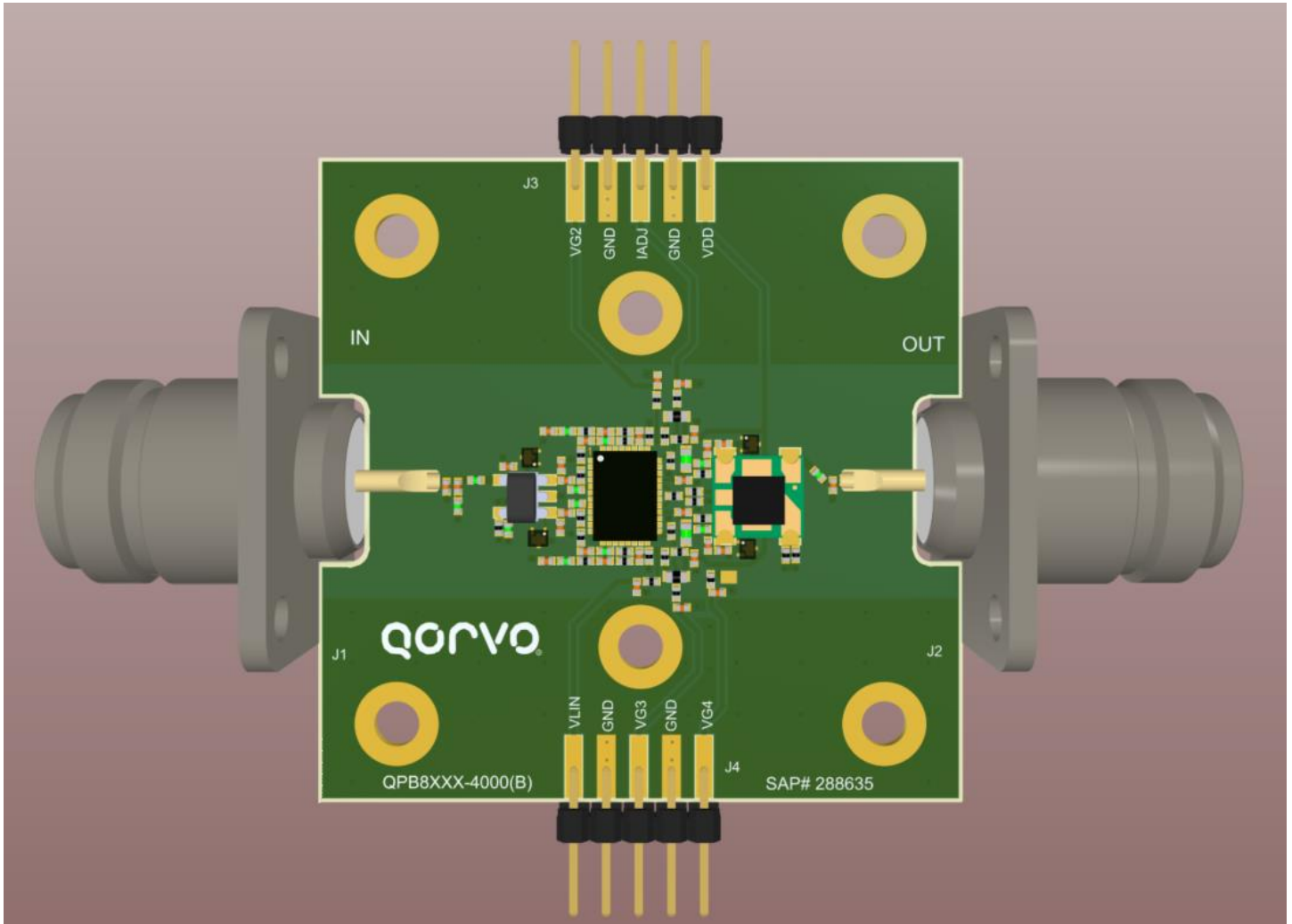

EVB PCB Material and Stack-up

Board Material: 0.030" FR4, $\epsilon_r=4.2$
 Plating: 1oz Copper
 Board Dimension: 1.9685" x 1.9685"

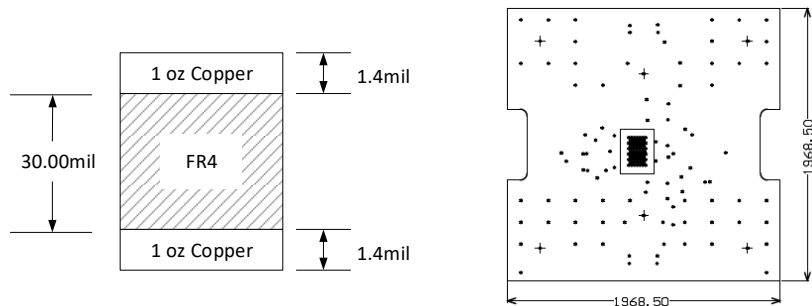

Evaluation Board Component Placement

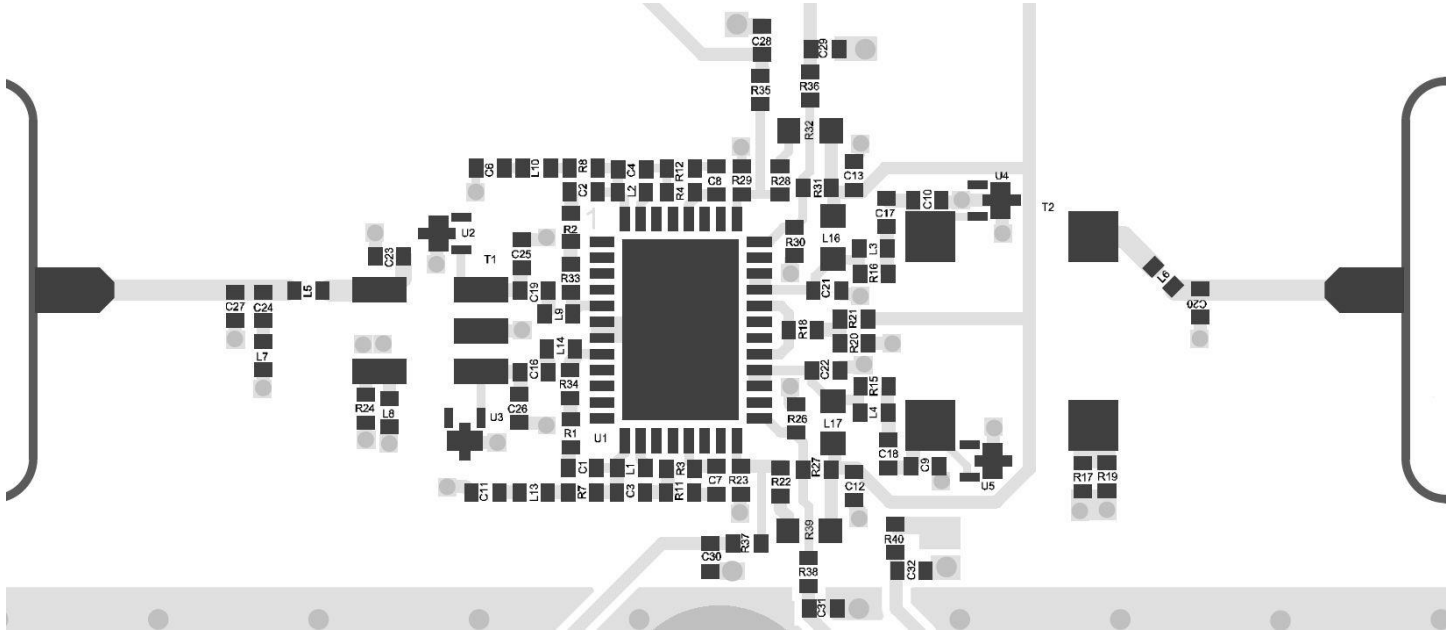

Typical Application Schematic; 24V

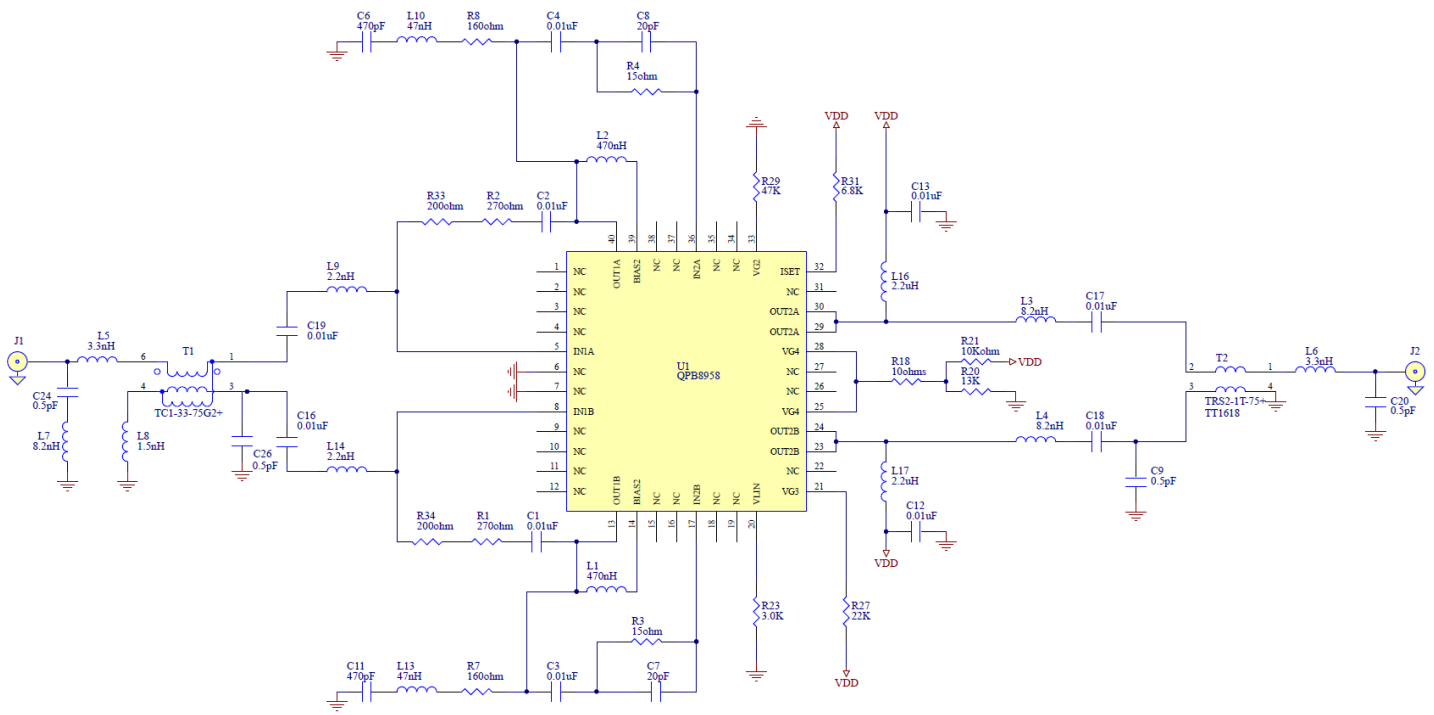

Performance Data 24V

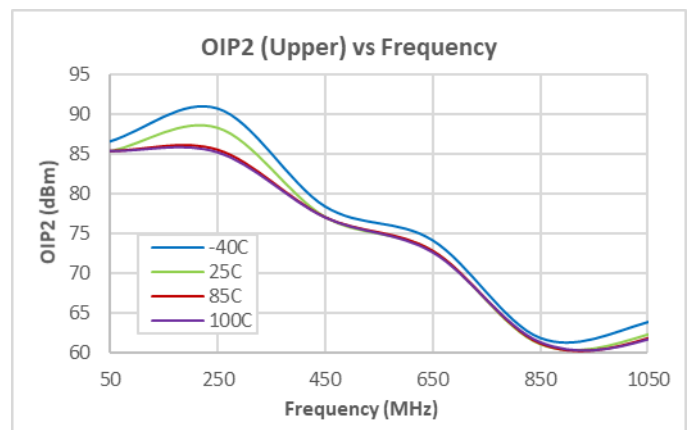
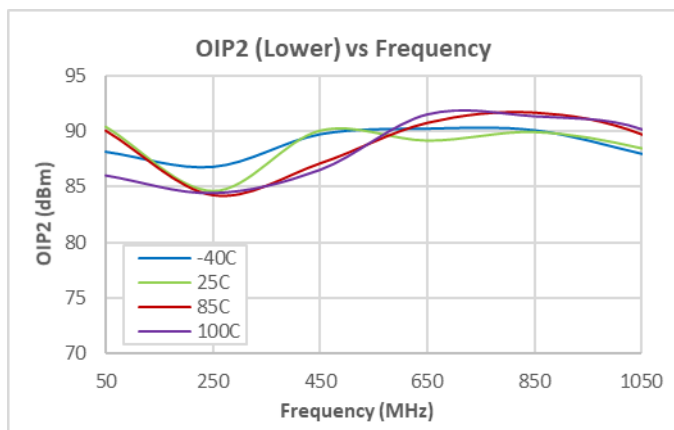
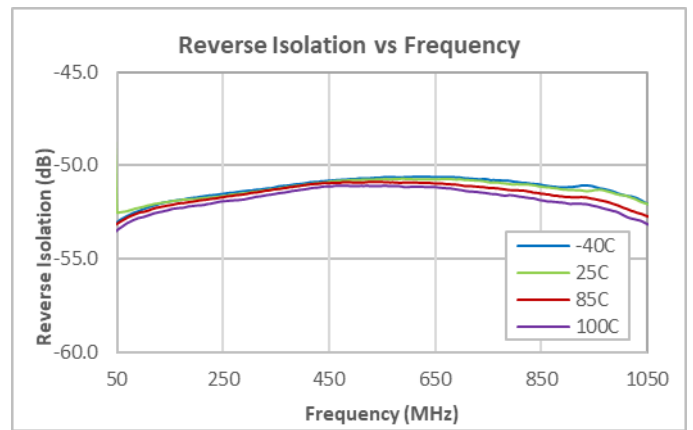
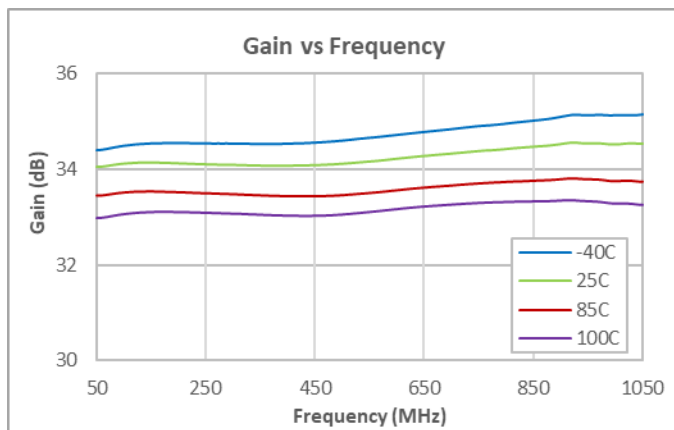
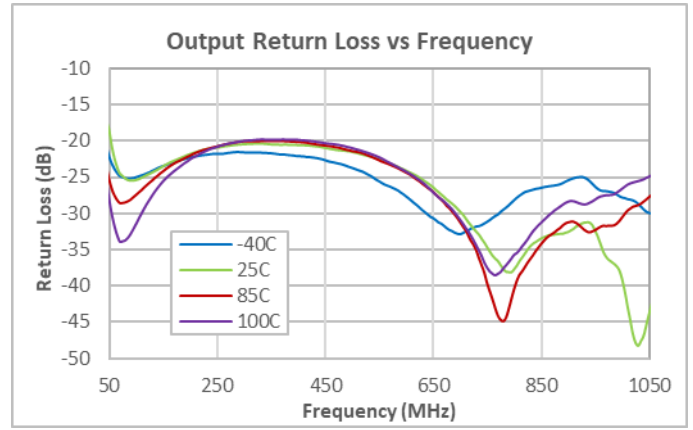
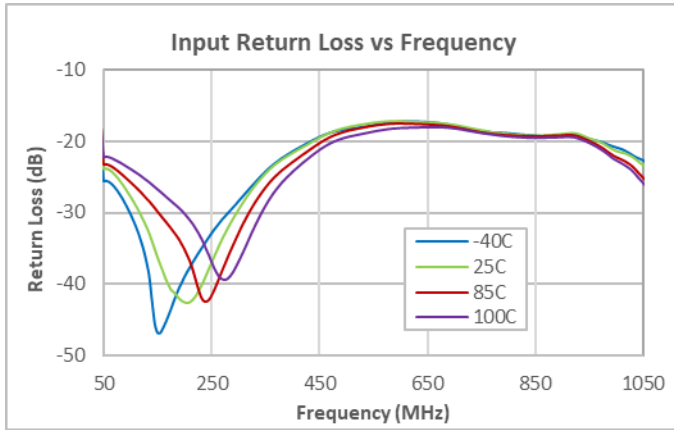

Test Conditions:

1. Test conditions unless otherwise noted: $V_{DD} = +24V$, $Z_o = 75\Omega$
2. OIP2: +12dBm per Tone.

Performance Data 24V

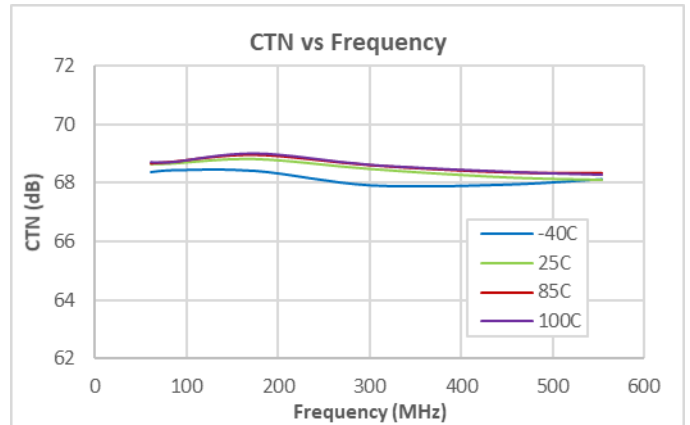
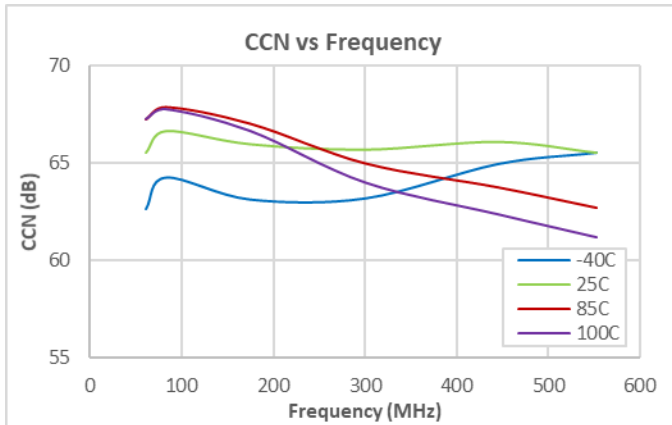
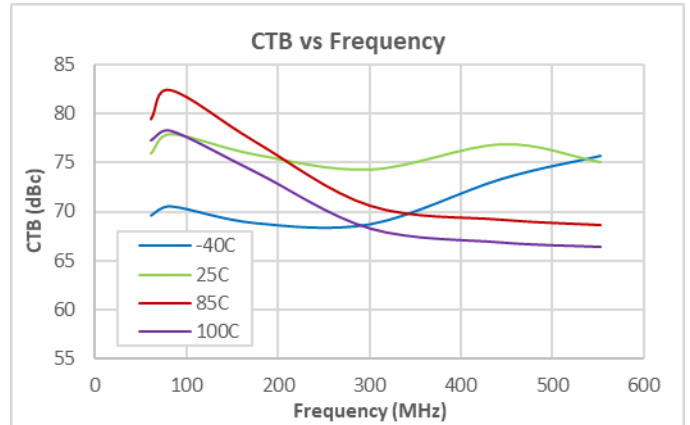
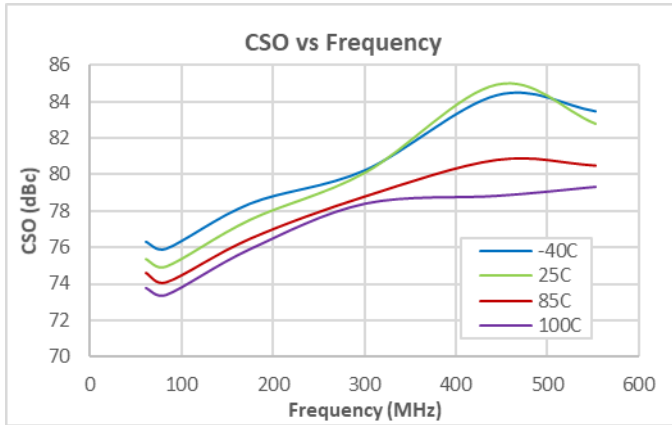
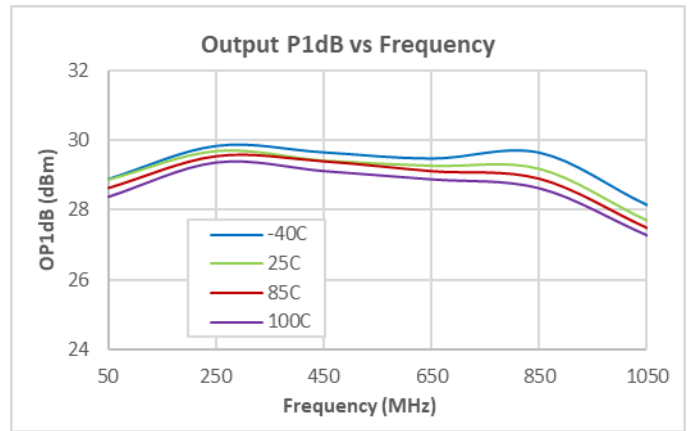
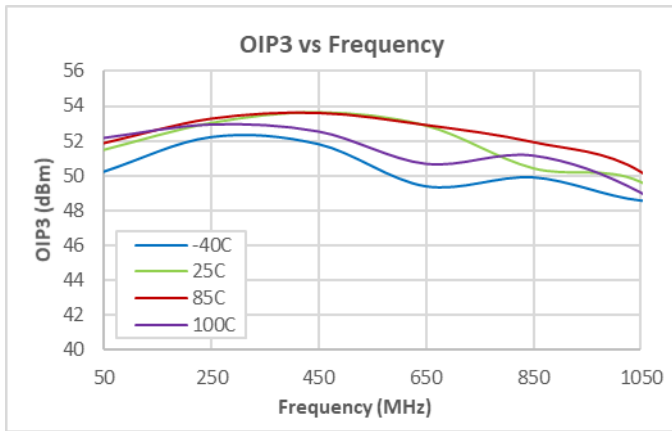

Test Conditions:

1. Test conditions unless otherwise noted: $V_{DD} = +24V$, $Z_o = 75\Omega$
2. OIP3: +12dBm per Tone.
3. CSO, CTB, CCN, CTN: 80 NTSC + 72 QAM (-6dB offset), 46dBmV/ch out, 0dB tilt

Performance Data 24V

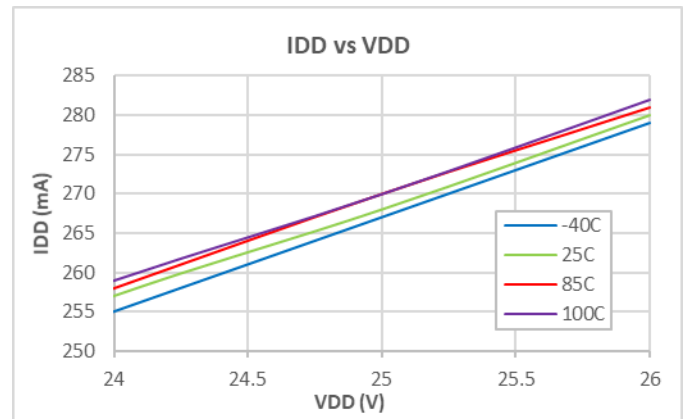
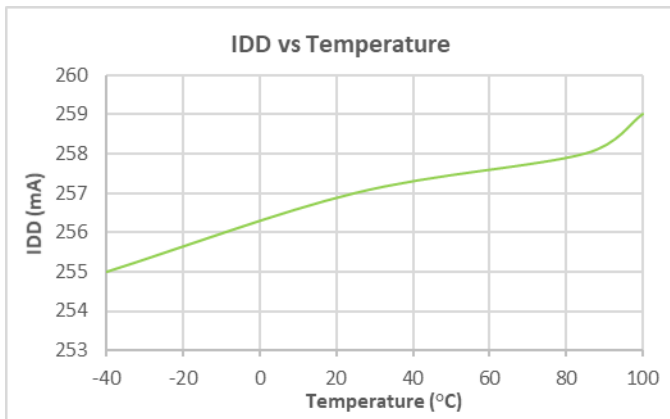
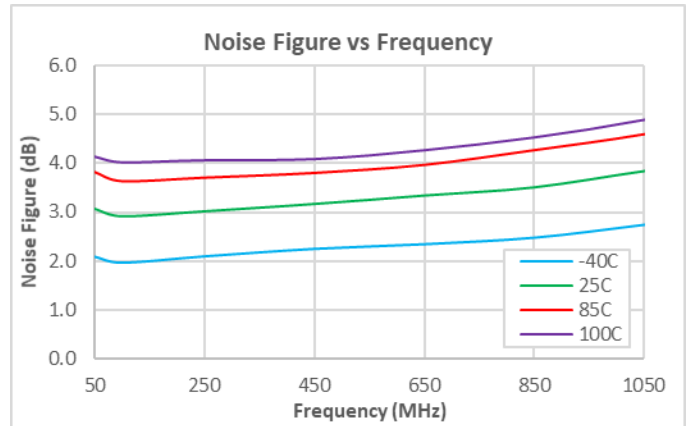
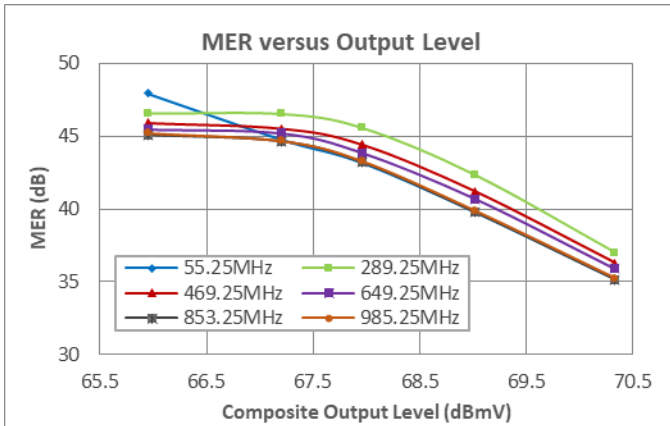

Test Conditions:

1. Test conditions unless otherwise noted: $V_{DD} = +24V$, $Z_o = 75\Omega$
2. MER: 160 QAM256 Channels Flat Tilt, 57-1003MHz, ITU-T J.83, Annex B

Pin Configuration and Description

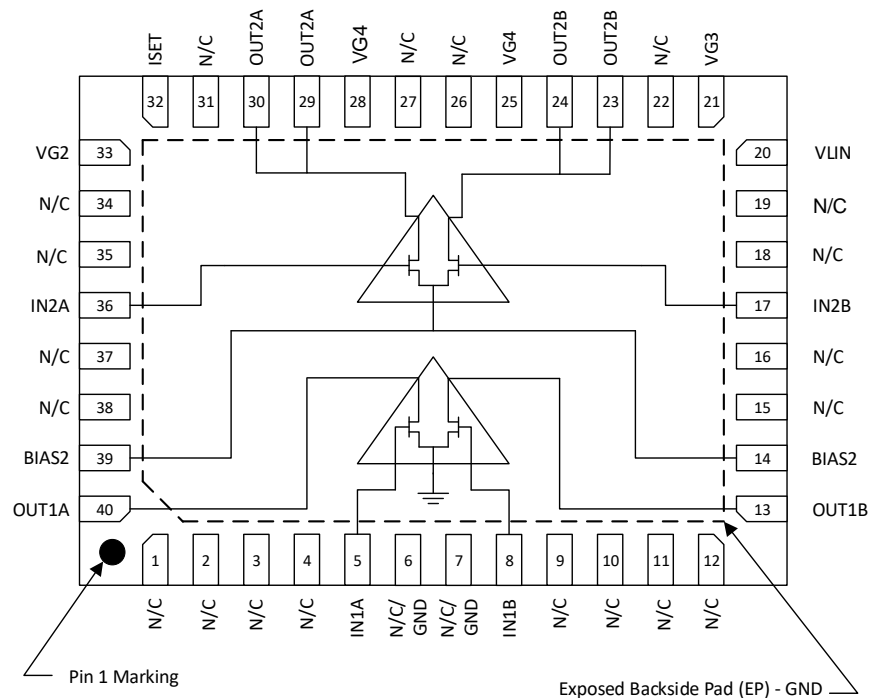

Top View

Pad No.	Label	Description
5	IN1A	RF input 1A
8	IN1B	RF input 1B
13	OUT1B	RF output 1B
14, 39	BIAS2	2nd Stage virtual ground
17	IN2B	RF input 2B
20	VLIN	Linearizer current set
21	VG3	VG3 adjust
23, 24	OUT2B	RF output 2B
25, 28	VG4	VG4 set
29, 30	OUT2A	RF output 2A
32	ISET	IDD set
33	VG2	VG2 adjust
36	IN2A	RF input 2A
40	OUT1A	RF output 1A
1, 2, 3, 4, 9, 10, 11, 12, 15, 16, 18, 19, 22, 26, 27, 31, 34, 35, 37, 38	N/C	No Connect
6, 7	N/C/GND	No Connect or Ground
Backside Paddle	GND	Ground. Use recommended via pattern to minimize inductance and thermal resistance. See PCB Mounting Pattern for suggested footprint.

Package Outline

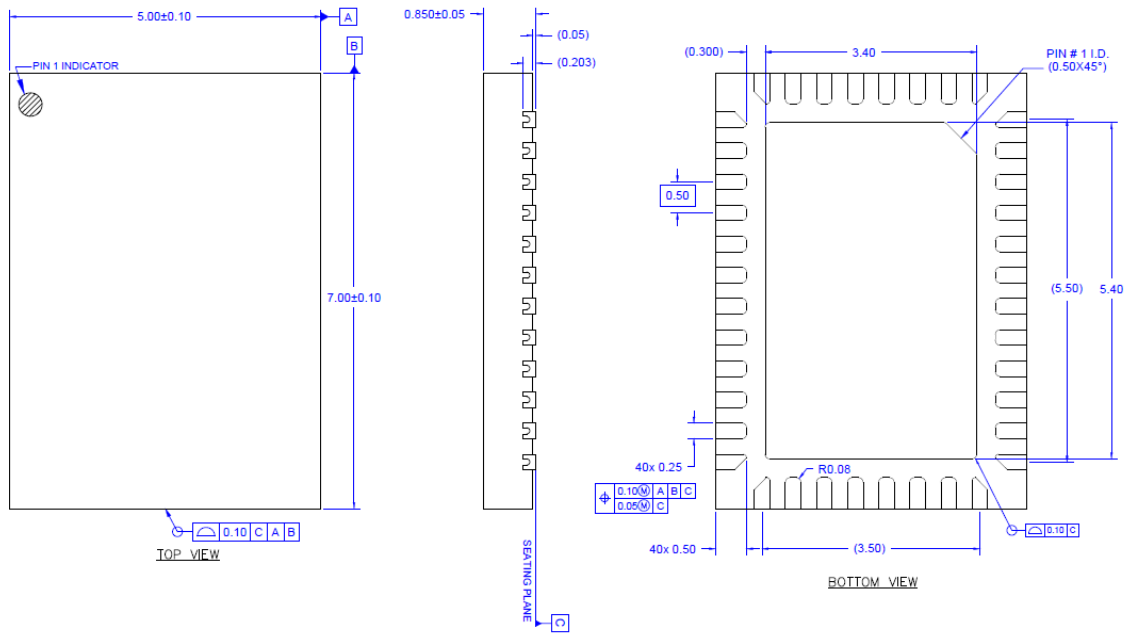

Notes:

1. Dimensions in millimeters

Package Marking

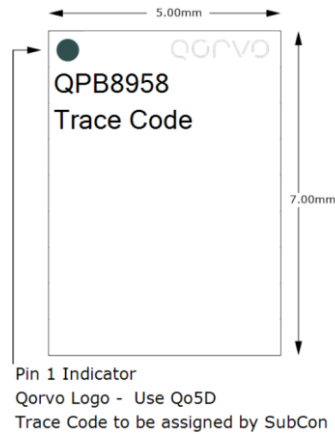

1. Dimension and tolerance formats conform to ASME Y14.4M-1994.
2. The terminal #1 identifier and terminal numbering conform to JESD 95-1 SPP-012.
3. Co-planarity applies to the exposed ground/thermal pad as well as the contact pins.
4. Package body length/width does not include plastic flash protrusion across mold parting line.

Recommended Mounting Pattern

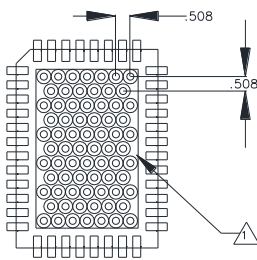

VIA PATTERN

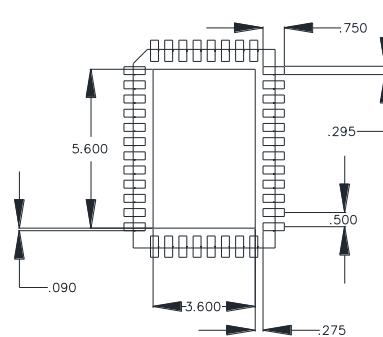

LAND PATTERN

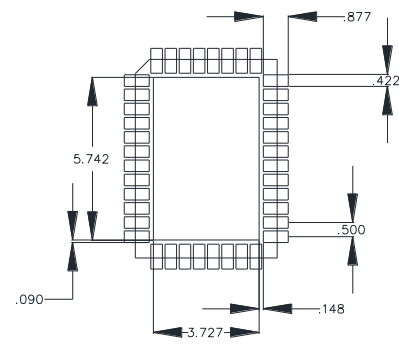

SOLDER MASK

NOTES:

1. GROUND/THERMAL VIAS AND MOUNTING HOLES ARE ESSENTIAL FOR THE PROPER DEVICE PERFORMANCE. DO NOT OMIT. VIAS SHOULD USE A .35mm (#80/.0135") DIAMETER DRILL AND HAVE A FINAL, PLATED THRU DIAMETER OF .25mm (.010").
2. TO ENSURE RELIABLE OPERATION, DEVICE GROUND PADDLE-TO-GROUND PAD SOLDER JOINT IS CRITICAL. NO SOLDER MASK ON BACKSIDE OF PCB IN HEAT SINK CONTACT AREA.
3. ALL DIMENSIONS ARE IN MILLIMETERS. ANGLES ARE IN DEGREES.

- Ensure good package backside paddle solder attach for reliable operation and best electrical performance.
- Place mounting screws near the part to fasten a back-side heat sink.
- Do not apply solder mask to the back side of the PC board in the heat sink contact region.
- Ensure that the backside via region makes good physical contact with the heat sink.

Handling Precautions

Parameter	Rating	Standard	 Caution! ESD-Sensitive Device
ESD – Human Body Model (HBM)	1B (500V)	ANSI / ESDA / JEDEC JS-001	
ESD – Charged Device Model (CDM)	C3 (1000V)	ANSI / ESDA / JEDEC JS-002	
MSL – Moisture Sensitivity Level	MSL3	IPC / JEDEC J-STD-020	

Solderability

Compatible with both lead-free (260°C max. reflow temp.) and tin/lead (245°C max. reflow temp.) soldering processes.

Solder profiles available upon request.

Contact plating: NiPdAu

RoHS Compliance

This part is compliant with 2011/65/EU RoHS directive (Restrictions on the Use of Certain Hazardous Substances in Electrical and Electronic Equipment) as amended by Directive 2015/863/EU.

This product also has the following attributes:

- Lead Free
- Halogen Free (Chlorine, Bromine)
- Antimony Free
- TBBP-A (C₁₅H₁₂Br₄O₂) Free
- PFOS Free
- SVHC Free



Contact Information

For the latest specifications, additional product information, worldwide sales and distribution locations:

Tel: **1-844-890-8163**

Web: www.qorvo.com

Email: customer.support@qorvo.com

Important Notice

The information contained herein is believed to be reliable; however, Qorvo makes no warranties regarding the information contained herein and assumes no responsibility or liability whatsoever for the use of the information contained herein. All information contained herein is subject to change without notice. Customers should obtain and verify the latest relevant information before placing orders for Qorvo products. The information contained herein or any use of such information does not grant, explicitly or implicitly, to any party any patent rights, licenses, or any other intellectual property rights, whether with regard to such information itself or anything described by such information. **THIS INFORMATION DOES NOT CONSTITUTE A WARRANTY WITH RESPECT TO THE PRODUCTS DESCRIBED HEREIN, AND QORVO HEREBY DISCLAIMS ANY AND ALL WARRANTIES WITH RESPECT TO SUCH PRODUCTS WHETHER EXPRESS OR IMPLIED BY LAW, COURSE OF DEALING, COURSE OF PERFORMANCE, USAGE OF TRADE OR OTHERWISE, INCLUDING THE IMPLIED WARRANTIES OF MERCHANTABILITY AND FITNESS FOR A PARTICULAR PURPOSE.**

Without limiting the generality of the foregoing, Qorvo products are not warranted or authorized for use as critical components in medical, life-saving, or life-sustaining applications, or other applications where a failure would reasonably be expected to cause severe personal injury or death.

Copyright 2020 © Qorvo, Inc. | Qorvo is a registered trademark of Qorvo, Inc.

Данный компонент на территории Российской Федерации

Вы можете приобрести в компании MosChip.

Для оперативного оформления запроса Вам необходимо перейти по данной ссылке:

<http://moschip.ru/get-element>

Вы можете разместить у нас заказ для любого Вашего проекта, будь то серийное производство или разработка единичного прибора.

В нашем ассортименте представлены ведущие мировые производители активных и пассивных электронных компонентов.

Нашей специализацией является поставка электронной компонентной базы двойного назначения, продукции таких производителей как XILINX, Intel (ex.ALTERA), Vicor, Microchip, Texas Instruments, Analog Devices, Mini-Circuits, Amphenol, Glenair.

Сотрудничество с глобальными дистрибьюторами электронных компонентов, предоставляет возможность заказывать и получать с международных складов практически любой перечень компонентов в оптимальные для Вас сроки.

На всех этапах разработки и производства наши партнеры могут получить квалифицированную поддержку опытных инженеров.

Система менеджмента качества компании отвечает требованиям в соответствии с ГОСТ Р ИСО 9001, ГОСТ РВ 0015-002 и ЭС РД 009

Офис по работе с юридическими лицами:

105318, г.Москва, ул.Щербаковская д.3, офис 1107, 1118, ДЦ «Щербаковский»

Телефон: +7 495 668-12-70 (многоканальный)

Факс: +7 495 668-12-70 (доб.304)

E-mail: info@moschip.ru

Skype отдела продаж:

moschip.ru

moschip.ru_4

moschip.ru_6

moschip.ru_9