



Features

- Compliant with AEC-Q200 Rev-C Stress Test Qualification for Passive Components in Automotive Applications
- Compact design to save board space - 1206 footprint
- Small size results in very fast time to react to fault events
- Symmetrical design
- Low profile
- RoHS compliant* and halogen free**
- Agency recognition:   

MF-NSMF Series - PTC Resettable Fuses

Electrical Characteristics

| Model | V max. Volts | I max. Amps | I _{hold} | I _{trip} | Resistance | | Max. Time To Trip | | Tripped Power Dissipation |
|-----------------|--------------|-------------|-------------------|-------------------|-------------------|--------------------|-------------------|------------------|---------------------------|
| | | | Amperes at 23 °C | | Ohms at 23 °C | | Amperes at 23 °C | Seconds at 23 °C | Watts at 23 °C |
| | | | Hold | Trip | R _{Min.} | R _{1Max.} | | | Typ. |
| MF-NSMF012 | 30.0 | 10 | 0.12 | 0.29 | 1.35 | 8.50 | 1.0 | 0.20 | 0.4 |
| MF-NSMF020 | 24.0 | 10 | 0.20 | 0.46 | 0.60 | 2.60 | 1.0 | 0.60 | 0.6 |
| MF-NSMF020X*** | 30.0 | 60 | 0.20 | 0.40 | 0.60 | 3.30 | 1.0 | 0.60 | 0.6 |
| MF-NSMF035 | 6.0 | 100 | 0.35 | 0.75 | 0.30 | 1.20 | 8.0 | 0.10 | 0.6 |
| MF-NSMF035X**** | 16.0 | 20 | 0.35 | 0.75 | 0.30 | 1.40 | 3.5 | 0.14 | 0.6 |
| MF-NSMF050 | 13.2 | 100 | 0.50 | 1.00 | 0.15 | 0.70 | 8.0 | 0.10 | 0.4 |
| MF-NSMF075 | 6.0 | 100 | 0.75 | 1.50 | 0.10 | 0.40 | 8.0 | 0.10 | 0.4 |
| MF-NSMF110 | 6.0 | 100 | 1.10 | 2.20 | 0.06 | 0.20 | 8.0 | 0.10 | 0.6 |
| MF-NSMF150 | 6.0 | 100 | 1.50 | 3.00 | 0.03 | 0.13 | 8.0 | 0.30 | 0.6 |
| MF-NSMF150D | 6.0 | 100 | 1.50 | 3.00 | 0.03 | 0.11 | 8.0 | 0.30 | 1.0 |
| MF-NSMF200 | 6.0 | 100 | 2.00 | 4.00 | 0.02 | 0.085 | 8.0 | 1.00 | 0.7 |

***Features Multifuse® freeXpansion Design™ for MF-NSMF Series (CSA/TÜV pending)

****Features Multifuse® freeXpansion Design™ for MF-NSMF Series (CSA pending)

Environmental Characteristics

| | |
|---|---|
| Operating Temperature..... | -40 °C to +85 °C |
| Maximum Device Surface Temperature in Tripped State | 125 °C |
| Passive Aging | +85 °C, 1000 hours..... ±5 % typical resistance change |
| Humidity Aging..... | +85 °C, 85 % R.H. 1000 hours ±5 % typical resistance change |
| Thermal Shock | +85 °C to -40 °C, 20 times..... ±10 % typical resistance change |
| Solvent Resistance..... | MIL-STD-202, Method 215 No change |
| Vibration | MIL-STD-883C, Method 2007.1,..... No change Condition A |

Test Procedures And Requirements For Model MF-NSMF Series

| Test | Test Conditions | Accept/Reject Criteria |
|------------------------------|---|--|
| Visual/Mech..... | Verify dimensions and materials..... | Per MF physical description |
| Resistance..... | In still air @ 23 °C..... | R _{min} ≤ R ≤ R _{1max} |
| Time to Trip..... | At specified current, V _{max} , 23 °C..... | T ≤ max. time to trip (seconds) |
| Hold Current | 30 min. at I _{hold} | No trip |
| Trip Cycle Life..... | V _{max} , I _{max} , 100 cycles..... | No arcing or burning |
| Trip Endurance | V _{max} , 48 hours..... | No arcing or burning |
| Solderability..... | ANSI/J-STD-002..... | 95 % min. coverage |
| UL File Number | E174545 http://www.ul.com/ Follow link to Certifications, then UL File No., enter E174545 | |
| CSA File Number..... | CA110338 http://directories.csa-international.org/ Under "Certification Record" and "File Number" enter 110338-0-000 | |
| TÜV Certificate Number | R 02057213 http://www.tuvdotcom.com/ Follow link to "other certificates", enter File No. 2057213 | |

*RoHS Directive 2002/95/EC Jan. 27, 2003 including annex and RoHS Recast 2011/65/EU June 8, 2011.

**Bourns follows the prevailing definition of "halogen free" in the industry. Bourns considers a product to be "halogen free" if (a) the Bromine (Br) content is 900 ppm or less; (b) the Chlorine (Cl) content is 900 ppm or less; and (c) the total Bromine (Br) and Chlorine (Cl) content is 1500 ppm or less.

Specifications are subject to change without notice.

Customers should verify actual device performance in their specific applications.

Applications

- USB port protection - USB 2.0, 3.0 & OTG
- HDMI 1.4 Source protection
- PC motherboards - Plug and Play protection
- Mobile phones - Battery and port protection
- PDAs / digital cameras
- Game console port protection
- Automotive electronic control modules

MF-NSMF Series - PTC Resettable Fuses

BOURNS®

Thermal Derating Chart - I_{hold} (Amps)

| Model | Ambient Operating Temperature | | | | | | | | |
|-------------|-------------------------------|--------|------|-------|-------|-------|-------|-------|-------|
| | -40 °C | -20 °C | 0 °C | 23 °C | 40 °C | 50 °C | 60 °C | 70 °C | 85 °C |
| MF-NSMF012 | 0.19 | 0.17 | 0.15 | 0.12 | 0.11 | 0.10 | 0.09 | 0.08 | 0.07 |
| MF-NSMF020 | 0.30 | 0.27 | 0.24 | 0.20 | 0.18 | 0.16 | 0.14 | 0.12 | 0.11 |
| MF-NSMF020X | 0.30 | 0.27 | 0.24 | 0.20 | 0.18 | 0.16 | 0.14 | 0.12 | 0.10 |
| MF-NSMF035 | 0.51 | 0.46 | 0.40 | 0.35 | 0.30 | 0.27 | 0.24 | 0.22 | 0.18 |
| MF-NSMF035X | 0.58 | 0.51 | 0.44 | 0.35 | 0.31 | 0.28 | 0.24 | 0.21 | 0.16 |
| MF-NSMF050 | 0.76 | 0.68 | 0.59 | 0.50 | 0.44 | 0.40 | 0.35 | 0.32 | 0.26 |
| MF-NSMF075 | 1.11 | 1.00 | 0.85 | 0.75 | 0.67 | 0.61 | 0.52 | 0.50 | 0.42 |
| MF-NSMF110 | 1.64 | 1.46 | 1.30 | 1.10 | 0.92 | 0.83 | 0.80 | 0.65 | 0.52 |
| MF-NSMF150 | 2.20 | 1.99 | 1.77 | 1.50 | 1.34 | 1.23 | 1.10 | 1.01 | 0.84 |
| MF-NSMF150D | 2.20 | 1.99 | 1.77 | 1.50 | 1.34 | 1.23 | 1.10 | 1.01 | 0.84 |
| MF-NSMF200 | 2.88 | 2.61 | 2.28 | 2.00 | 1.80 | 1.66 | 1.51 | 1.39 | 1.19 |

Typical Time to Trip at 23 °C

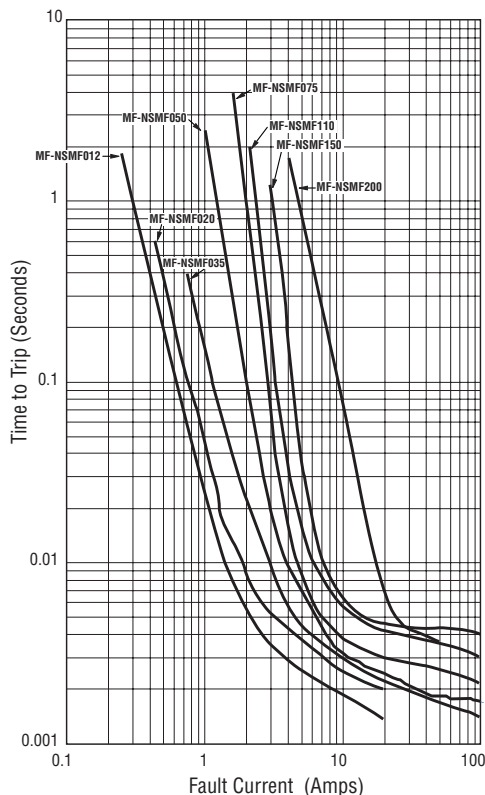

The Time to Trip curves represent typical performance of a device in a simulated application environment. Actual performance in specific customer applications may differ from these values due to the influence of other variables.

How to Order

MF - NSMF 020 X - 2

Multifuse® Product Designator

Series NSMF = 1206 Surface Mount Component

Hold Current, I_{hold} 012-200 (0.12 Amps - 2.00 Amps)

Options = Standard
 D = Multifuse® freeExpansion Design™
 MF-NSMF Series

Packaging Packaged per EIA 481-1
 -2 = Tape and Reel

Typical Part Marking

Represents total content. Layout may vary.

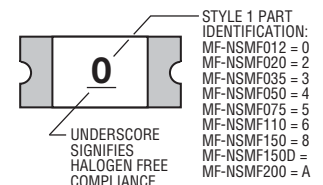

BIWEEKLY DATE CODE WILL APPEAR ON THE PACKAGING LABEL:
 WEEK 1 AND 2 = A
 WEEK 51 AND 52 = Z

MF-NSMF Series - PTC Resettable Fuses

BOURNS®

Product Dimensions

| Model | A | | B | | C | | D | Style |
|-------------|------------------------|------------------------|------------------------|------------------------|------------------------|------------------------|------------------------|-------|
| | Min. | Max. | Min. | Max. | Min. | Max. | Min. | |
| MF-NSMF012 | $\frac{3.00}{(0.118)}$ | $\frac{3.40}{(0.134)}$ | $\frac{1.40}{(0.055)}$ | $\frac{1.80}{(0.071)}$ | $\frac{0.70}{(0.028)}$ | $\frac{1.10}{(0.043)}$ | $\frac{0.25}{(0.010)}$ | 1 |
| MF-NSMF020 | $\frac{3.00}{(0.118)}$ | $\frac{3.40}{(0.134)}$ | $\frac{1.40}{(0.055)}$ | $\frac{1.80}{(0.071)}$ | $\frac{0.48}{(0.019)}$ | $\frac{0.85}{(0.033)}$ | $\frac{0.25}{(0.010)}$ | 1 |
| MF-NSMF020X | $\frac{3.00}{(0.118)}$ | $\frac{3.40}{(0.134)}$ | $\frac{1.40}{(0.055)}$ | $\frac{1.80}{(0.071)}$ | $\frac{0.40}{(0.016)}$ | $\frac{0.85}{(0.033)}$ | $\frac{0.25}{(0.010)}$ | 2 |
| MF-NSMF035 | $\frac{3.00}{(0.118)}$ | $\frac{3.40}{(0.134)}$ | $\frac{1.40}{(0.055)}$ | $\frac{1.80}{(0.071)}$ | $\frac{0.48}{(0.019)}$ | $\frac{0.85}{(0.033)}$ | $\frac{0.25}{(0.010)}$ | 1 |
| MF-NSMF035X | $\frac{3.00}{(0.118)}$ | $\frac{3.40}{(0.134)}$ | $\frac{1.40}{(0.055)}$ | $\frac{1.80}{(0.071)}$ | $\frac{0.40}{(0.016)}$ | $\frac{0.85}{(0.033)}$ | $\frac{0.25}{(0.010)}$ | 2 |
| MF-NSMF050 | $\frac{3.00}{(0.118)}$ | $\frac{3.40}{(0.134)}$ | $\frac{1.40}{(0.055)}$ | $\frac{1.80}{(0.071)}$ | $\frac{0.48}{(0.019)}$ | $\frac{0.85}{(0.033)}$ | $\frac{0.25}{(0.010)}$ | 1 |
| MF-NSMF075 | $\frac{3.00}{(0.118)}$ | $\frac{3.40}{(0.134)}$ | $\frac{1.40}{(0.055)}$ | $\frac{1.80}{(0.071)}$ | $\frac{0.40}{(0.016)}$ | $\frac{0.70}{(0.028)}$ | $\frac{0.25}{(0.010)}$ | 1 |
| MF-NSMF110 | $\frac{3.00}{(0.118)}$ | $\frac{3.40}{(0.134)}$ | $\frac{1.40}{(0.055)}$ | $\frac{1.80}{(0.071)}$ | $\frac{0.40}{(0.016)}$ | $\frac{0.70}{(0.028)}$ | $\frac{0.25}{(0.010)}$ | 1 |
| MF-NSMF150 | $\frac{3.00}{(0.118)}$ | $\frac{3.40}{(0.134)}$ | $\frac{1.40}{(0.055)}$ | $\frac{1.80}{(0.071)}$ | $\frac{0.40}{(0.016)}$ | $\frac{0.70}{(0.028)}$ | $\frac{0.25}{(0.010)}$ | 1 |
| MF-NSMF150D | $\frac{3.00}{(0.118)}$ | $\frac{3.40}{(0.134)}$ | $\frac{1.40}{(0.055)}$ | $\frac{1.80}{(0.071)}$ | $\frac{0.40}{(0.016)}$ | $\frac{0.75}{(0.030)}$ | $\frac{0.25}{(0.010)}$ | 1 |
| MF-NSMF200 | $\frac{3.00}{(0.118)}$ | $\frac{3.50}{(0.138)}$ | $\frac{1.40}{(0.055)}$ | $\frac{1.80}{(0.071)}$ | $\frac{0.70}{(0.028)}$ | $\frac{1.60}{(0.063)}$ | $\frac{0.25}{(0.010)}$ | 1 |

Packaging: 3000 pcs. per reel.

DIMENSIONS: $\frac{\text{MM}}{\text{(INCHES)}}$

Style 1 Top and Bottom View

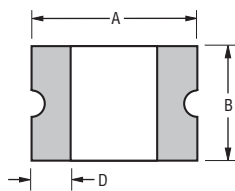

Style 1 Side View

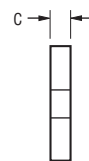

Style 1 Recommended Pad Layout

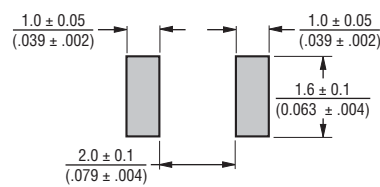

Terminal material:

Electroless Ni under immersion Au

Termination pad solderability:

Standard Au finish:
Meets ANSI/J-STD-002 Category 2.

Recommended Storage:

40 °C max./70 % RH max.

Style 2 Top View

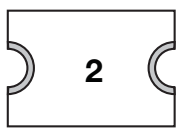

Style 2 Bottom View

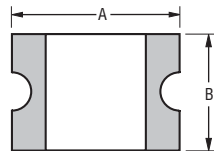

Style 2 Side View

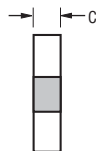

Style 2 Recommended Pad Layout

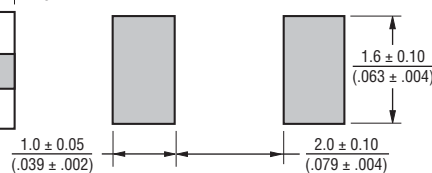

Solder Reflow Recommendations

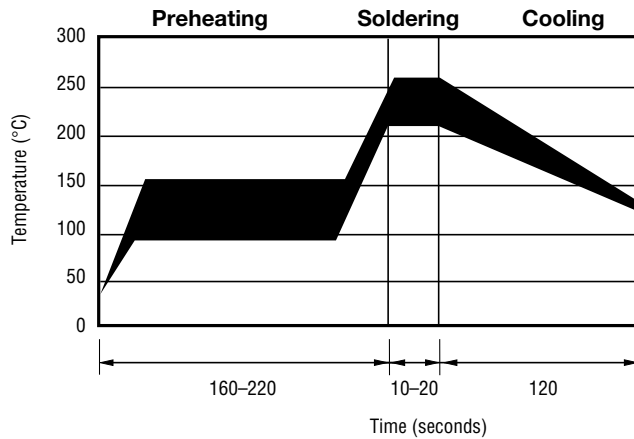

Notes:

- MF-NSMF models cannot be wave soldered. Please contact Bourns for hand soldering recommendations.
- If reflow temperatures exceed the recommended profile, devices may not meet the performance requirements.
- Compatible with Pb and Pb-free solder reflow profiles.
- Excess solder may cause a short circuit, especially during hand soldering. Please refer to the Multifuse® Polymer PTC Soldering Recommendation guidelines.

MF-NSMF Series Tape and Reel Specifications

BOURNS®

| Tape Dimensions | MF-NSMF012 & MF-NSMF200 per EIA 481-1 | MF-NSMF020 ~ MF-NSMF050 & MF-NSMF150D per EIA 481-1 | MF-NSMF075 ~ MF-NSMF150 per EIA 481-1 | MF-NSMF020X & MF-NSMF035X per EIA 481-1 |
|------------------------|---|---|---|---|
| W | 8.0 ± 0.30 (0.315 ± 0.012) | 8.0 ± 0.30 (0.315 ± 0.012) | 8.0 ± 0.30 (0.315 ± 0.012) | 8.0 ± 0.30 (0.315 ± 0.012) |
| P ₀ | 4.0 ± 0.10 (0.157 ± 0.004) | 4.0 ± 0.10 (0.157 ± 0.004) | 4.0 ± 0.10 (0.157 ± 0.004) | 4.0 ± 0.10 (0.157 ± 0.004) |
| P ₁ | 4.0 ± 0.10 (0.157 ± 0.004) | 4.0 ± 0.10 (0.157 ± 0.004) | 4.0 ± 0.10 (0.157 ± 0.004) | 4.0 ± 0.10 (0.157 ± 0.004) |
| P ₂ | 2.0 ± 0.05 (0.079 ± 0.002) | 2.0 ± 0.05 (0.079 ± 0.002) | 2.0 ± 0.05 (0.079 ± 0.002) | 2.0 ± 0.05 (0.079 ± 0.002) |
| A ₀ | 1.90 ± 0.10 (0.075 ± 0.004) | 1.90 ± 0.10 (0.075 ± 0.004) | 1.90 ± 0.10 (0.075 ± 0.004) | 1.90 ± 0.10 (0.075 ± 0.004) |
| B ₀ | 3.50 ± 0.10 (0.138 ± 0.004) | 3.45 ± 0.10 (0.136 ± 0.004) | 3.45 ± 0.10 (0.136 ± 0.004) | 3.55 ± 0.10 (0.140 ± 0.004) |
| B ₁ max. | 4.35 (0.171) | 4.35 (0.171) | 4.35 (0.171) | 4.35 (0.171) |
| D ₀ | $1.5 + 0.10/-0.0$ (0.059 + 0.004/-0) | $1.5 + 0.10/-0.0$ (0.059 + 0.004/-0) | $1.5 + 0.10/-0.0$ (0.059 + 0.004/-0) | $1.5 + 0.10/-0.0$ (0.059 + 0.004/-0) |
| F | 3.5 ± 0.05 (0.138 ± 0.002) | 3.5 ± 0.05 (0.138 ± 0.002) | 3.5 ± 0.05 (0.138 ± 0.002) | 3.5 ± 0.05 (0.138 ± 0.002) |
| E ₁ | 1.75 ± 0.10 (0.069 ± 0.004) | 1.75 ± 0.10 (0.069 ± 0.004) | 1.75 ± 0.10 (0.069 ± 0.004) | 1.75 ± 0.10 (0.069 ± 0.004) |
| E ₂ min. | 6.25 (0.246) | 6.25 (0.246) | 6.25 (0.246) | 6.25 (0.246) |
| T max. | 0.6 (0.024) | 0.6 (0.024) | 0.6 (0.024) | 0.6 (0.024) |
| T ₁ max. | 0.1 (0.004) | 0.1 (0.004) | 0.1 (0.004) | 0.1 (0.004) |
| K ₀ | 1.35 ± 0.10 (0.053 ± 0.004) | 1.04 ± 0.10 (0.041 ± 0.004) | 0.85 ± 0.10 (0.033 ± 0.004) | 0.80 ± 0.10 (0.032 ± 0.004) |
| Leader min. | 390 (15.35) | 390 (15.35) | 390 (15.35) | 390 (15.35) |
| Trailer min. | 160 (6.30) | 160 (6.30) | 160 (6.30) | 160 (6.30) |
| Reel Dimensions | | | | |
| A max. | 185 (7.28) | 185 (7.28) | 185 (7.28) | 185 (7.28) |
| N min. | 50 (1.97) | 50 (1.97) | 50 (1.97) | 50 (1.97) |
| W ₁ | $8.4 + 1.5/-0.0$ (0.331 + 0.059/-0.0) | $8.4 + 1.5/-0.0$ (0.331 + 0.059/-0.0) | $8.4 + 1.5/-0.0$ (0.331 + 0.059/-0.0) | $8.4 + 1.5/-0.0$ (0.331 + 0.059/-0.0) |
| W ₂ max. | 14.4 (0.567) | 14.4 (0.567) | 14.4 (0.567) | 14.4 (0.567) |

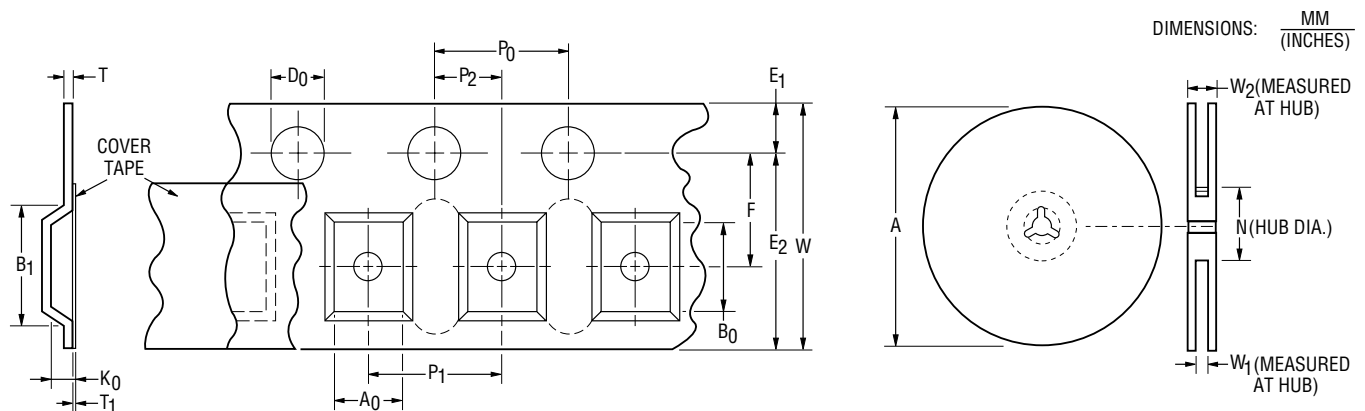

Specifications are subject to change without notice.
Customers should verify actual device performance in their specific applications.

Данный компонент на территории Российской Федерации

Вы можете приобрести в компании MosChip.

Для оперативного оформления запроса Вам необходимо перейти по данной ссылке:

<http://moschip.ru/get-element>

Вы можете разместить у нас заказ для любого Вашего проекта, будь то серийное производство или разработка единичного прибора.

В нашем ассортименте представлены ведущие мировые производители активных и пассивных электронных компонентов.

Нашей специализацией является поставка электронной компонентной базы двойного назначения, продукции таких производителей как XILINX, Intel (ex.ALTERA), Vicor, Microchip, Texas Instruments, Analog Devices, Mini-Circuits, Amphenol, Glenair.

Сотрудничество с глобальными дистрибьюторами электронных компонентов, предоставляет возможность заказывать и получать с международных складов практически любой перечень компонентов в оптимальные для Вас сроки.

На всех этапах разработки и производства наши партнеры могут получить квалифицированную поддержку опытных инженеров.

Система менеджмента качества компании отвечает требованиям в соответствии с ГОСТ Р ИСО 9001, ГОСТ РВ 0015-002 и ЭС РД 009

Офис по работе с юридическими лицами:

105318, г.Москва, ул.Щербаковская д.3, офис 1107, 1118, ДЦ «Щербаковский»

Телефон: +7 495 668-12-70 (многоканальный)

Факс: +7 495 668-12-70 (доб.304)

E-mail: info@moschip.ru

Skype отдела продаж:

moschip.ru

moschip.ru_4

moschip.ru_6

moschip.ru_9