

SOT23, 3V/5V, Single-Supply, Rail-to-Rail Instrumentation Amplifiers

General Description

The MAX4460/MAX4461/MAX4462 are instrumentation amplifiers with precision specifications, low-power consumption, and excellent gain-bandwidth product. Proprietary design techniques allow ground-sensing capability combined with ultra-low input current and increased common-mode rejection performance. These rail-to-rail output instrumentation amplifiers are offered in fixed or adjustable gains and the option for either a shut-down mode or a pin to set the output voltage relative to an external reference (see the *Ordering Information* and *Selector Guide*).

The MAX4460 has an adjustable gain and uses ground as its reference voltage. The MAX4461 is offered in fixed gains of 1, 10, and 100, uses ground as its reference voltage, and has a logic-controlled shutdown input. The MAX4462 is offered in fixed gains of 1, 10, and 100 and has a reference input pin (REF). REF sets the output voltage for zero differential input to allow bipolar signals in single-supply applications.

The MAX4460/MAX4461/MAX4462 have high-impedance inputs optimized for small-signal differential voltages. The MAX4461/MAX4462 are factory trimmed to gains of 1, 10, or 100 (suffixed U, T, and H) with $\pm 0.1\%$ accuracy. The typical offset of the MAX4460/MAX4461/MAX4462 is $100\mu\text{V}$. All devices have a gain-bandwidth product of 2.5MHz.

These amplifiers operate with a single-supply voltage from 2.85V to 5.25V and with a quiescent current of only $700\mu\text{A}$ (less than $1\mu\text{A}$ in shutdown for the MAX4461). The MAX4462 can also be operated with dual supplies. Smaller than most competitors, the MAX4460/MAX4461/MAX4462 are available in space-saving 6-pin SOT23 and TDFN packages.

Applications

- Industrial Process Control
- Strain-Gauge Amplifiers
- Transducer Interface
- Precision Low-Side Current Sense
- Low-Noise Microphone Preamplifier
- Differential Voltage Amplification
- Battery-Powered Medical Equipment

Selector Guide appears at end of data sheet.

Pin Configurations appear at end of data sheet.

Features

- ◆ Tiny 6-Pin SOT23 and TDFN Packages
- ◆ Input Negative Rail Sensing
- ◆ 1pA (typ) Input Bias Current
- ◆ 100 μV Input Offset Voltage
- ◆ Rail-to-Rail Output
- ◆ 2.85V to 5.25V Single Supply
- ◆ 700 μA Supply Current
- ◆ $\pm 0.1\%$ Gain Error
- ◆ 2.5MHz Gain-Bandwidth Product
- ◆ 18nV/ $\sqrt{\text{Hz}}$ Input-Referred Noise

Ordering Information

PART	TEMP RANGE	PIN-PACKAGE	TOP MARK
MAX4460ETT+T	-40°C to +85°C	6 TDFN-EP*	+ANI
MAX4460EUT-T	-40°C to +85°C	6 SOT23-6	AASS
MAX4460ESA	-40°C to +85°C	8 SO	—
MAX4461UETT+T	-40°C to +85°C	6 TDFN-EP*	+ANJ
MAX4461UEUT-T	-40°C to +85°C	6 SOT23-6	AAST
MAX4461UESA	-40°C to +85°C	8 SO	—
MAX4461TETT+T	-40°C to +85°C	6 TDFN-EP*	+ANK
MAX4461TEUT-T	-40°C to +85°C	6 SOT23-6	AASU
MAX4461TESA	-40°C to +85°C	8 SO	—
MAX4461HETT+T	-40°C to +85°C	6 TDFN-EP*	+ANL
MAX4461HEUT-T	-40°C to +85°C	6 SOT23-6	AASV
MAX4461HESA	-40°C to +85°C	8 SO	—

+Denotes lead-free package.

*EP = Exposed paddle.

Ordering Information continued at end of data sheet.

Typical Application Circuits

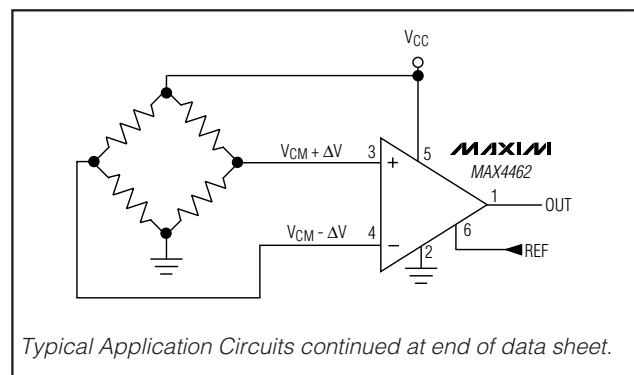

SOT23, 3V/5V, Single-Supply, Rail-to-Rail Instrumentation Amplifiers

ABSOLUTE MAXIMUM RATINGS

Supply Voltage (V_{DD} to V_{SS})-0.3V to +6V
 All Other Pins(V_{SS} - 0.3V) to (V_{DD} + 0.3V)
 Output Short-Circuit Duration to Either Supply1s
 Continuous Power Dissipation (T_A = +70°C)
 6-Pin SOT23 (derate 8.7mW/°C above +70°C).....695mW
 6-Pin TDFN-EP (derate 18.2mW/°C above +70°C)....1454mW
 8-Pin SO (derate 5.9mW/°C above +70°C).....470mW

Operating Temperature Range-40°C to +85°C
 Junction Temperature+150°C
 Storage Temperature Range-65°C to +150°C
 Lead Temperature (soldering, 10s).....300°C

Stresses beyond those listed under "Absolute Maximum Ratings" may cause permanent damage to the device. These are stress ratings only, and functional operation of the device at these or any other conditions beyond those indicated in the operational sections of the specifications is not implied. Exposure to absolute maximum rating conditions for extended periods may affect device reliability.

ELECTRICAL CHARACTERISTICS—MAX4460/MAX4461

(V_{DD} = 5V, V_{CM} = 0V, V_{DIFF} = V_{IN+} - V_{IN-} = 50mV to 100mV for G = 1, 20mV to 100mV for G = 10, 2mV to 48mV for G =100, MAX4460 is configured for G = 10, R_L = 200kΩ to GND, T_A = +25°C, unless otherwise noted.)

PARAMETER	SYMBOL	CONDITIONS	MIN	TYP	MAX	UNITS
Supply Voltage	V _{DD}	Guaranteed by PSRR test	2.85		5.25	V
Supply Current		V _{DD} = 5V, V _{DIFF} = 0V		0.80	1.1	mA
		V _{DD} = 3V, V _{DIFF} = 0V		0.68	0.9	
Shutdown Supply Current		MAX4461, $\overline{\text{SHDN}}$ = GND V _{DD} = 5V		0.1	1	μA
Input Offset Voltage (Note 1)	V _{OS}	MAX4460ESA		±50	±425	μV
		MAX4461ESA		±50	±300	
		MAX446_EUT/MAX446_ETT		±100	±600	
Input Resistance	R _{IN}	V _{CM} = V _{DD} /2	Differential mode	2		GΩ
			Common mode	2		
Input Common-Mode Range	V _{CM}	Guaranteed by CMRR test	-0.1		V _{DD} - 1.7	V
Input Common-Mode Rejection Ratio	CMRR	V _{CM} = -0.1V to (V _{DD} - 1.7V)	90	120		dB
Power-Supply Rejection Ratio	PSRR	V _{DD} = 2.85V to 5.25V	80	100		dB
Input Bias Current	I _B	(Note 2)		1	100	pA
FB Input Current		MAX4460 (Note 2)		1	100	pA
$\overline{\text{SHDN}}$ Logic Levels	V _{IH}	MAX4461	0.7X			V
	V _{IL}	MAX4461			0.3X V _{DD}	
$\overline{\text{SHDN}}$ Input Current		MAX4461, V $\overline{\text{SHDN}}$ = 0V or V _{DD} (Note 2)		1	100	pA
Input Voltage Noise	e _n	f = 10kHz		18		nV/√Hz
		f = 1kHz		38		
Output Voltage Swing	V _{OH}	V _{DD} - V _{OH} (Note 3)	R _L = 200kΩ	1	2.5	mV
			R _L = 20kΩ	3	5	
	V _{OL}	R _L = 200kΩ	0	0.2		
		R _L = 20kΩ	0	0.2		
Short-Circuit Current	I _{SC}	(Note 4)		±150		mA

SOT23, 3V/5V, Single-Supply, Rail-to-Rail Instrumentation Amplifiers

MAX4460/MAX4461/MAX4462

ELECTRICAL CHARACTERISTICS—MAX4460/MAX4461 (continued)

($V_{DD} = 5V$, $V_{CM} = 0V$, $V_{DIFF} = V_{IN+} - V_{IN-} = 50mV$ to $100mV$ for $G = 1$, $20mV$ to $100mV$ for $G = 10$, $2mV$ to $48mV$ for $G = 100$, MAX4460 is configured for $G = 10$, $R_L = 200k\Omega$ to GND, $T_A = +25^\circ C$, unless otherwise noted.)

PARAMETER	SYMBOL	CONDITIONS		MIN	TYP	MAX	UNITS
Gain Error		$R_L = 20k\Omega$	$G = 1V/V$, MAX4461UESA		0.1	0.3	%
			$G = 10V/V$, MAX4461TESA		0.12	0.35	
			$G = 100V/V$, MAX4461HESA		0.15	0.6	
			$G = 10V/V$, MAX4460ESA		0.15	0.35	
			MAX446_EUT/MAX446_ETT		0.15	0.6	
Nonlinearity (Note 1)		$R_L = 20k\Omega$		0.05	0.15	%	
Maximum Capacitive Load	C_L	No sustained oscillations			100		pF
-3dB Bandwidth	BW _{-3dB}	$C_L = 100pF$	$G = 1V/V$, MAX4461U		2500		kHz
			$G = 10V/V$, MAX4461T		250		
			$G = 100V/V$, MAX4461H		25		
Gain-Bandwidth Product	GBWP	$C_L = 100pF$			2.5		MHz
Slew Rate	SR	$C_L = 100pF$	$G = 1V/V$		0.5		V/ μs
			$G = 10V/V$		0.5		
			$G = 100V/V$		0.25		
Settling Time	t_s	$C_L = 100pF$, within 0.1% of final value	$G = 1V/V$		15		μs
			$G = 10V/V$		75		
			$G = 100V/V$		250		

ELECTRICAL CHARACTERISTICS—MAX4460/MAX4461

($V_{DD} = 5V$, $V_{CM} = 0V$, $V_{DIFF} = V_{IN+} - V_{IN-} = 50mV$ to $100mV$ for $G = 1$, $20mV$ to $100mV$ for $G = 10$, $2mV$ to $48mV$ for $G = 100$, MAX4460 is configured for $G = 10$, $R_L = 200k\Omega$ to GND, $T_A = T_{MIN}$ to T_{MAX} , unless otherwise noted.)

PARAMETER	SYMBOL	CONDITIONS		MIN	TYP	MAX	UNITS	
Supply Voltage	V_{DD}	Guaranteed by PSRR test		2.85		5.25	V	
Supply Current		$V_{DD} = 5V$, $V_{DIFF} = 0V$				1.4	mA	
		$V_{DD} = 3V$, $V_{DIFF} = 0V$				1.15		
Shutdown Supply Current		MAX4461, SHDN = GND	$V_{DD} = 5V$			1	μA	
Input Offset Voltage (Note 1)	V_{OS}	MAX4460ESA	$T_A = 0^\circ C$ to $+85^\circ C$			± 750	μV	
			$T_A = -40^\circ C$ to $+85^\circ C$			± 950		
		MAX4461ESA	$T_A = 0^\circ C$ to $+85^\circ C$	$G = 1$				± 750
				$G = 10$				± 500
				$G = 100$				± 500
			$T_A = -40^\circ C$ to $+85^\circ C$	$G = 1$				± 950
				$G = 10$				± 750
				$G = 100$				± 750
		MAX446_EUT/ MAX446_ETT	$T_A = 0^\circ C$ to $+85^\circ C$					± 1400
$T_A = -40^\circ C$ to $+85^\circ C$					± 1900			
Input Offset-Voltage Drift	TC _{VOS}	(Note 1)			1.5	$\mu V/^\circ C$		

SOT23, 3V/5V, Single-Supply, Rail-to-Rail Instrumentation Amplifiers

MAX4460/MAX4461/MAX4462

ELECTRICAL CHARACTERISTICS—MAX4460/MAX4461 (continued)

($V_{DD} = 5V$, $V_{CM} = 0V$, $V_{DIFF} = V_{IN+} - V_{IN-} = 50mV$ to $100mV$ for $G = 1$, $20mV$ to $100mV$ for $G = 10$, $2mV$ to $48mV$ for $G = 100$, MAX4460 is configured for $G = 10$, $R_L = 200k\Omega$ to GND, $T_A = T_{MIN}$ to T_{MAX} , unless otherwise noted.)

PARAMETER	SYMBOL	CONDITIONS		MIN	TYP	MAX	UNITS
Input Common-Mode Range	V_{CM}	Guaranteed by CMRR test		-0.1		$V_{DD} - 1.85$	V
Input Common-Mode Rejection Ratio	CMRR	$V_{CM} = -0.1V$ to $(V_{DD} - 1.85V)$		80			dB
Power-Supply Rejection Ratio	PSRR	$V_{DD} = 2.85V$ to $5.25V$		75			dB
Input Bias Current	I_B	(Note 2)				100	pA
FB Input Current		MAX4460 (Note 2)				100	pA
SHDN Logic Levels	V_{IH}	MAX4461		0.7X			V
	V_{IL}	MAX4461				0.3X V_{DD}	
SHDN Input Current		MAX4461, $V_{SHDN} = 0V$ or V_{DD} (Note 2)				100	pA
Output Voltage Swing	V_{OH}	$V_{DD} - V_{OH}$ (Note 3)	$R_L = 200k\Omega$			4	mV
			$R_L = 20k\Omega$			8	
	V_{OL}		$R_L = 200k\Omega$			0.25	
			$R_L = 20k\Omega$			0.25	
Gain Error		MAX4461UESA, $R_L = 20k\Omega$	$T_A = 0^\circ C$ to $+85^\circ C$			0.8	%
			$T_A = -40^\circ C$ to $+85^\circ C$			1.6	
		MAX4461TESA, $R_L = 20k\Omega$	$T_A = 0^\circ C$ to $+85^\circ C$			0.8	
			$T_A = -40^\circ C$ to $+85^\circ C$			1.7	
		MAX4461HESA, $R_L = 20k\Omega$	$T_A = 0^\circ C$ to $+85^\circ C$			1.0	
			$T_A = -40^\circ C$ to $+85^\circ C$			2.0	
		MAX4460ESA, $R_L = 20k\Omega$	$T_A = 0^\circ C$ to $+85^\circ C$			0.8	
			$T_A = -40^\circ C$ to $+85^\circ C$			2.0	
MAX446_EUT/ MAX446_ETT, $R_L = 20k\Omega$	$T_A = 0^\circ C$ to $+85^\circ C$			1.8			
	$T_A = -40^\circ C$ to $+85^\circ C$			3.0			
Nonlinearity		$R_L = 20k\Omega$ (Note 1)	$T_A = 0^\circ C$ to $+85^\circ C$			0.20	%
			$T_A = -40^\circ C$ to $+85^\circ C$			0.25	

SOT23, 3V/5V, Single-Supply, Rail-to-Rail Instrumentation Amplifiers

MAX4460/MAX4461/MAX4462

ELECTRICAL CHARACTERISTICS—MAX4462

($V_{DD} = 5V$, $V_{SS} = 0V$, $V_{CM} = V_{REF} = V_{DD}/2$, $R_L = 100k\Omega$ to $V_{DD}/2$, $T_A = +25^\circ C$, unless otherwise noted. $V_{DIFF} = V_{IN+} - V_{IN-} = -100mV$ to $+100mV$ for $G = 1$ and $G = 10$, $-20mV$ to $+20mV$ for $G = 100$.)

PARAMETER	SYMBOL	CONDITIONS	MIN	TYP	MAX	UNITS
Supply Voltage	V_{DD}	Guaranteed by PSRR test	2.85		5.25	V
Supply Current		$V_{DD} = 5V$, $V_{DIFF} = 0V$		0.8	1.1	mA
		$V_{DD} = 3V$, $V_{DIFF} = 0V$		0.68	0.9	
Input Offset Voltage (Note 1)	V_{OS}	MAX4462_ESA		± 50	± 250	μV
		MAX4462_EUT/MAX4462_ETT		± 100	± 500	
Input Resistance	R_{IN}	$V_{CM} = V_{DD}/2$	Differential mode	2		$G\Omega$
			Common mode	2		
Input Common-Mode Range	V_{CM}	Guaranteed by Input CMRR test	$V_{SS} - 0.1$		$V_{DD} - 1.7$	V
REF Input Range		Guaranteed by REF rejection test	$V_{SS} + 0.1$		$V_{DD} - 1.7$	V
Input Common-Mode Rejection Ratio	CMRR	$V_{CM} = (V_{SS} - 0.1V)$ to $(V_{DD} - 1.7V)$	90	120		dB
REF Input Rejection Ratio		$V_{CM} = (V_{SS} + 0.1V)$ to $(V_{DD} - 1.7V)$	85	100		dB
Power-Supply Rejection Ratio	PSRR	$V_{DD} = 2.85V$ to $5.25V$	80	100		dB
Input Bias Current	I_B	(Note 2)		1	100	pA
Input Voltage Noise	e_N	$f = 10kHz$		18		nV/\sqrt{Hz}
		$f = 1kHz$		38		
Output Voltage Swing	V_{OH}	$V_{DD} - V_{OH}$ (Note 3)	$R_L = 100k\Omega$	1	2.5	mV
			$R_L = 10k\Omega$	3	5	
	V_{OL}	$V_{OL} - V_{SS}$ (Note 3)	$R_L = 100k\Omega$	2	4	
			$R_L = 10k\Omega$	6	12	
Short-Circuit Current	I_{SC}	(Note 4)		± 150		mA
Gain Error		$R_L = 10k\Omega$	$G = 1V/V$, MAX4462UESA	0.1	0.30	%
			$G = 10V/V$, MAX4462TESA	0.12	0.35	
			$G = 100V/V$, MAX4462HESA	0.15	0.5	
			MAX4462_EUT/MAX4462_ETT	0.15	0.5	
Nonlinearity		$R_L = 10k\Omega$		0.05	0.15	%

SOT23, 3V/5V, Single-Supply, Rail-to-Rail Instrumentation Amplifiers

ELECTRICAL CHARACTERISTICS—MAX4462 (continued)

($V_{DD} = 5V$, $V_{SS} = 0V$, $V_{CM} = V_{REF} = V_{DD}/2$, $R_L = 100k\Omega$ to $V_{DD}/2$, $T_A = +25^\circ C$, unless otherwise noted. $V_{DIFF} = V_{IN+} - V_{IN-} = -100mV$ to $+100mV$ for $G = 1$ and $G = 10$, $-20mV$ to $+20mV$ for $G = 100$.)

PARAMETER	SYMBOL	CONDITIONS	MIN	TYP	MAX	UNITS
Maximum Capacitive Load	C_L	No sustained oscillations		100		pF
-3dB Bandwidth	BW_{-3dB}	$C_L = 100pF$	$G = 1V/V$, MAX4462U	2500		kHz
			$G = 10V/V$, MAX4462T	250		
			$G = 100V/V$, MAX4462H	25		
Gain-Bandwidth Product	GBWP	$C_L = 100pF$		2.5		MHz
Slew Rate	SR	$C_L = 100pF$	$G = 1V/V$, MAX4462U	0.5		V/ μs
			$G = 10V/V$, MAX4462T	0.5		
			$G = 100V/V$, MAX4462H	0.25		
Settling Time	t_s	$C_L = 100pF$, within 0.1% of final value	$G = 1V/V$, MAX4462U	15		μs
			$G = 10V/V$, MAX4462T	75		
			$G = 100V/V$, MAX4462H	250		

ELECTRICAL CHARACTERISTICS—MAX4462

($V_{DD} = 5V$, $V_{SS} = 0V$, $V_{CM} = V_{REF} = V_{DD}/2$, $R_L = 100k\Omega$ to $V_{DD}/2$, $T_A = T_{MIN}$ to T_{MAX} , unless otherwise noted. $V_{DIFF} = V_{IN+} - V_{IN-} = -100mV$ to $+100mV$ for $G = 1$ and $G = 10$, $-20mV$ to $+20mV$ for $G = 100$.) (Note 5)

PARAMETER	SYMBOL	CONDITIONS	MIN	TYP	MAX	UNITS
Supply Voltage	V_{DD}	Guaranteed by PSRR test	2.85		5.25	V
Supply Current		$V_{DD} = 5V$, $V_{DIFF} = 0V$			1.4	mA
		$V_{DD} = 3V$, $V_{DIFF} = 0V$			1.15	
Input Offset Voltage (Note 1)	V_{OS}	MAX4462_ESA	$T_A = 0^\circ C$ to $+85^\circ C$		± 500	μV
			$T_A = -40^\circ C$ to $+85^\circ C$		± 750	
		MAX4462_EUT/ MAX4462_ETT	$T_A = 0^\circ C$ to $+85^\circ C$		± 1100	
			$T_A = -40^\circ C$ to $+85^\circ C$		± 1300	
Input Offset Voltage Drift	TCV_{OS}	(Note 1)		1.5		$\mu V/^\circ C$
Input Common-Mode Range	V_{CM}	Guaranteed by input CMRR test	$V_{SS} - 0.1$		$V_{DD} - 1.85$	V
REF Input Range		Guaranteed by REF rejection test	$V_{SS} + 0.1$		$V_{DD} - 1.85$	V
Input Common-Mode Rejection Ratio	CMRR	$V_{CM} = (V_{SS} - 0.1V)$ to $(V_{DD} - 1.85V)$	80			dB
REF Input Rejection Ratio		$V_{CM} = (V_{SS} + 0.1V)$ to $(V_{DD} - 1.85V)$	75			dB
Power-Supply Rejection Ratio	PSRR	$V_{DD} = 2.85V$ to $5.25V$	75			dB
Input Bias Current	I_B	(Note 2)			100	pA

SOT23, 3V/5V, Single-Supply, Rail-to-Rail Instrumentation Amplifiers

MAX4460/MAX4461/MAX4462

ELECTRICAL CHARACTERISTICS—MAX4462 (continued)

($V_{DD} = 5V$, $V_{SS} = 0V$, $V_{CM} = V_{REF} = V_{DD}/2$, $R_L = 100k\Omega$ to $V_{DD}/2$, $T_A = T_{MIN}$ to T_{MAX} , unless otherwise noted. $V_{DIFF} = V_{IN+} - V_{IN-} = -100mV$ to $+100mV$ for $G = 1$ and $G = 10$, $-20mV$ to $+20mV$ for $G = 100$.) (Note 5)

PARAMETER	SYMBOL	CONDITIONS		MIN	TYP	MAX	UNITS
Output Voltage Swing	V_{OH}	$V_{DD} - V_{OH}$ (Note 3)	$R_L = 100k\Omega$			4	mV
			$R_L = 10k\Omega$			8	
	V_{OL}	$V_{OL} - V_{SS}$ (Note 3)	$R_L = 100k\Omega$			8	
			$R_L = 10k\Omega$			16	
Gain Error	GE	$R_L = 10k\Omega$, MAX4462UESA	$T_A = 0^\circ C$ to $+85^\circ C$			0.8	%
			$T_A = -40^\circ C$ to $+85^\circ C$			1.6	
		$R_L = 10k\Omega$, MAX4462TESA	$T_A = 0^\circ C$ to $+85^\circ C$			0.8	
			$T_A = -40^\circ C$ to $+85^\circ C$			1.7	
		$R_L = 10k\Omega$, MAX4462HESA	$T_A = 0^\circ C$ to $+85^\circ C$			0.8	
			$T_A = -40^\circ C$ to $+85^\circ C$			1.7	
		$R_L = 10k\Omega$, MAX4462_EUT/ MAX4462_ETT	$T_A = 0^\circ C$ to $+85^\circ C$			1.8	
			$T_A = -40^\circ C$ to $+85^\circ C$			3.0	
Nonlinearity	NL	$R_L = 10k\Omega$	$T_A = 0^\circ C$ to $+85^\circ C$			0.2	%
			$T_A = -40^\circ C$ to $+85^\circ C$			0.25	

Note 1: Offset Voltage is measured with a best straight-line (BSL) method (see *A User Guide to Instrumentation Amplifier Accuracy Specifications* section).

Note 2: $IN+$ and $IN-$ are gates to CMOS transistors with typical input bias current of 1pA. CMOS leakage is so small that it is impractical to test and guarantee in production. Limits shown are guaranteed by design. However, devices are functionally screened during production testing to eliminate defective units.

Note 3: Output swing high is measured only on $G = 100$ devices. Devices with $G = 1$ and $G = 10$ have output swing high limited by the range of V_{REF} , V_{CM} , and V_{DIFF} (see *Output Swing* section).

Note 4: Short-circuit duration limited to 1s (see *Absolute Maximum Ratings*).

Note 5: SOT23 and TDFN units are 100% production tested at $+25^\circ C$. Limits over temperature are guaranteed by design.

SOT23, 3V/5V, Single-Supply, Rail-to-Rail Instrumentation Amplifiers

Typical Operating Characteristics

($V_{DD} = 5V$, $V_{SS} = 0V$, $V_{IN+} = V_{IN-} = V_{REF} = V_{DD}/2$, $R_L = 100k\Omega$ to $V_{DD}/2$, $T_A = +25^\circ C$, unless otherwise noted. $V_{DIFF} = V_{IN+} - V_{IN-} = -100mV$ to $+100mV$ for $G = 1$ and $G = 10$, $-20mV$ to $+20mV$ for $G = 100$.)

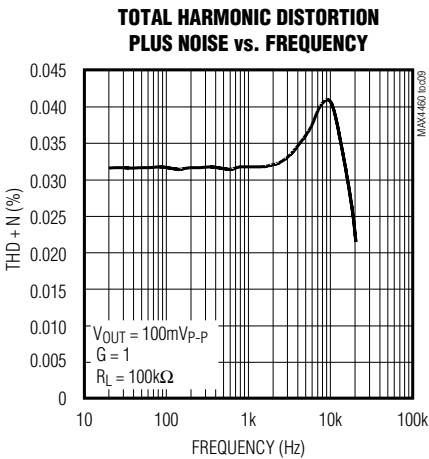
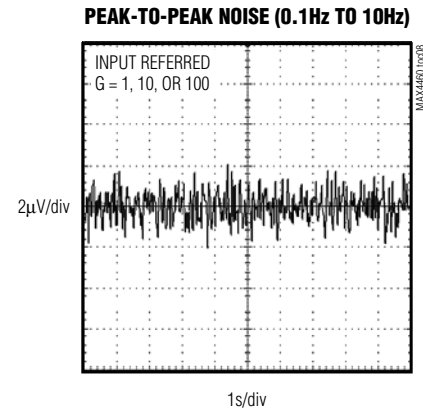
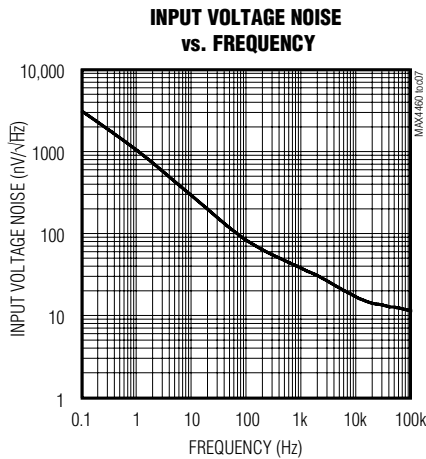
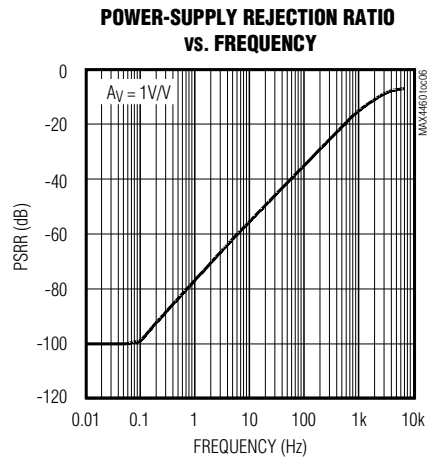
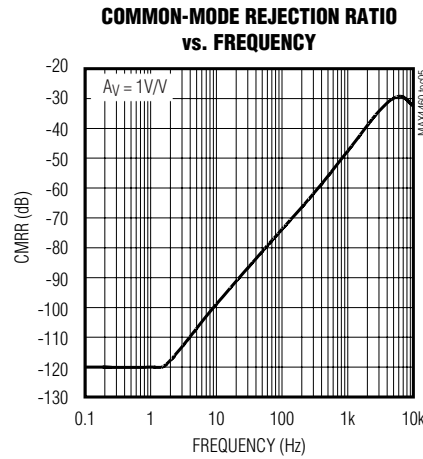
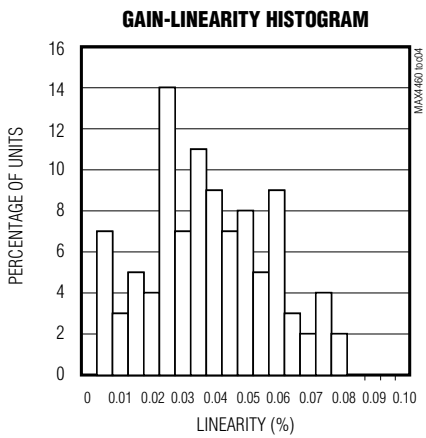
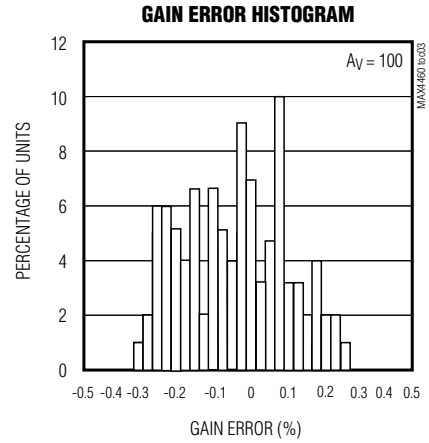
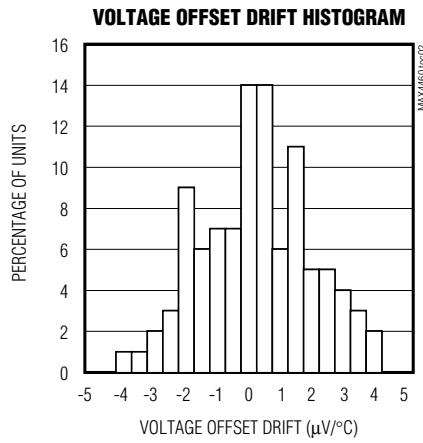
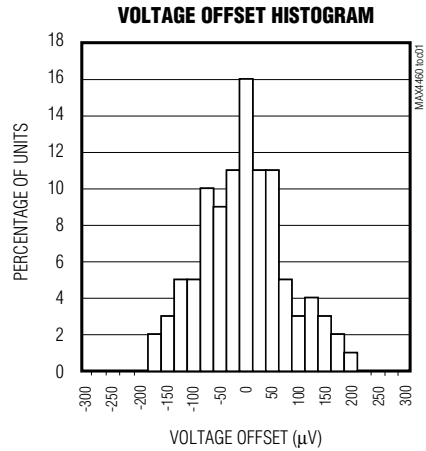

SOT23, 3V/5V, Single-Supply, Rail-to-Rail Instrumentation Amplifiers

Typical Operating Characteristics (continued)

($V_{DD} = 5V$, $V_{SS} = 0V$, $V_{IN+} = V_{IN-} = V_{REF} = V_{DD}/2$, $R_L = 100k\Omega$ to $V_{DD}/2$, $T_A = +25^\circ C$, unless otherwise noted. $V_{DIFF} = V_{IN+} - V_{IN-} = -100mV$ to $+100mV$ for $G = 1$ and $G = 10$, $-20mV$ to $+20mV$ for $G = 100$.)

MAX4460/MAX4461/MAX4462

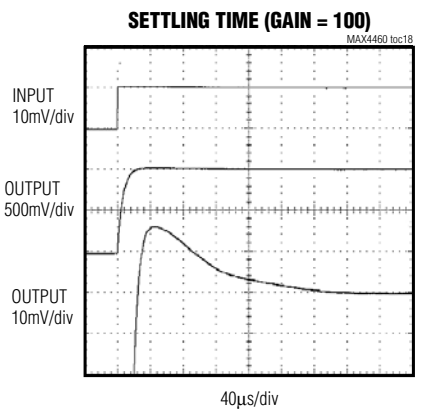
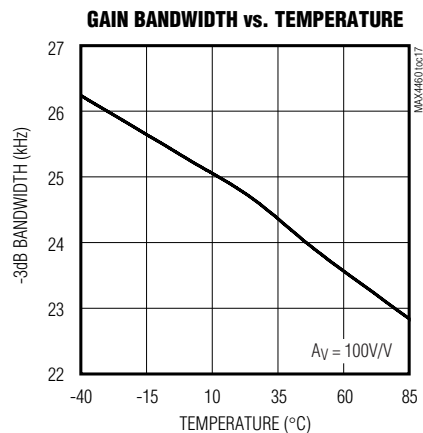
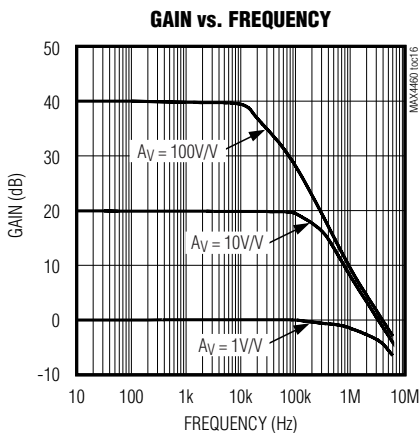
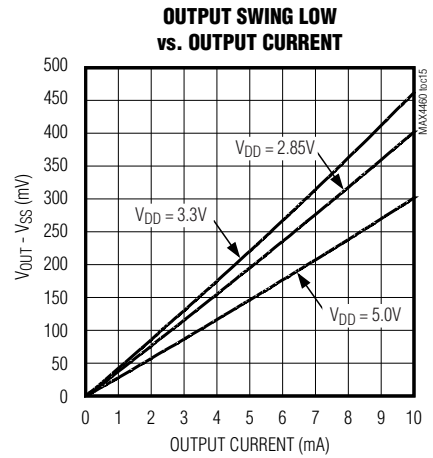
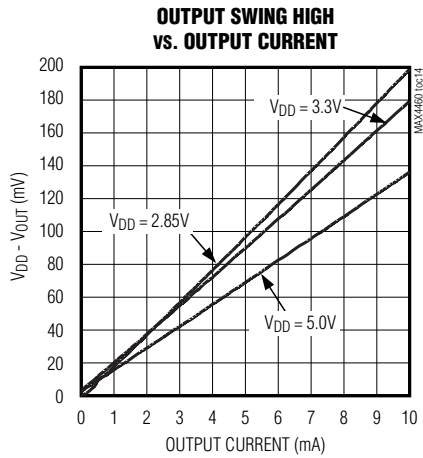
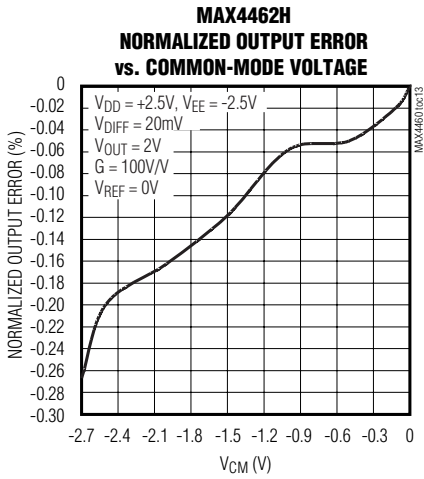
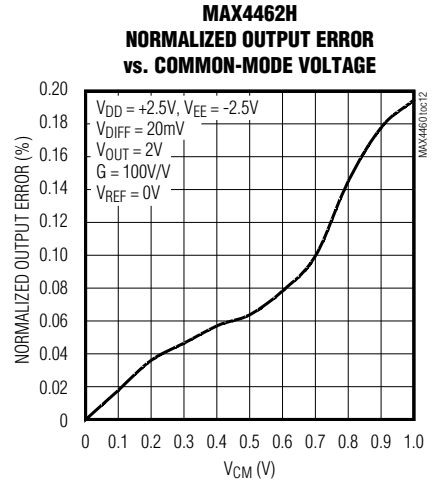
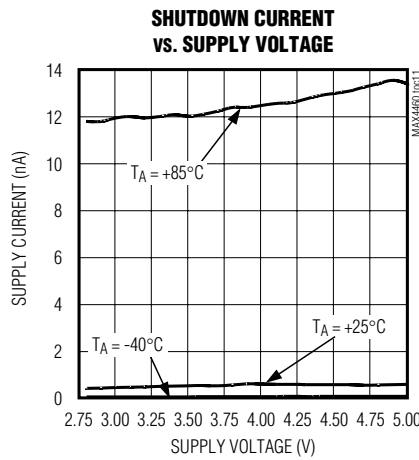
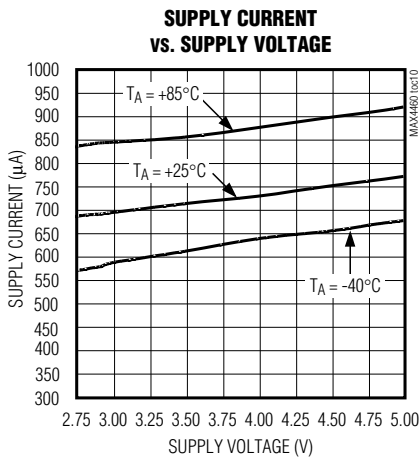

SOT23, 3V/5V, Single-Supply, Rail-to-Rail Instrumentation Amplifiers

Typical Operating Characteristics (continued)

($V_{DD} = 5V$, $V_{SS} = 0V$, $V_{IN+} = V_{IN-} = V_{REF} = V_{DD}/2$, $R_L = 100k\Omega$ to $V_{DD}/2$, $T_A = +25^\circ C$, unless otherwise noted. $V_{DIFF} = V_{IN+} - V_{IN-} = -100mV$ to $+100mV$ for $G = 1$ and $G = 10$, $-20mV$ to $+20mV$ for $G = 100$.)

**LARGE-SIGNAL PULSE RESPONSE
(GAIN = 1V/V)**

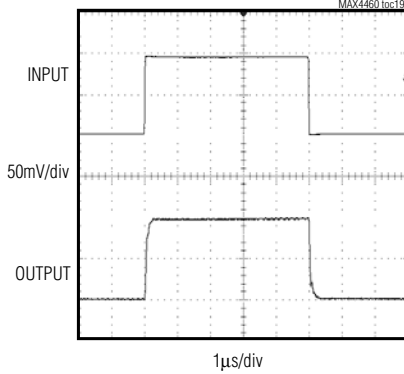

**LARGE-SIGNAL PULSE RESPONSE
(GAIN = 100V/V)**

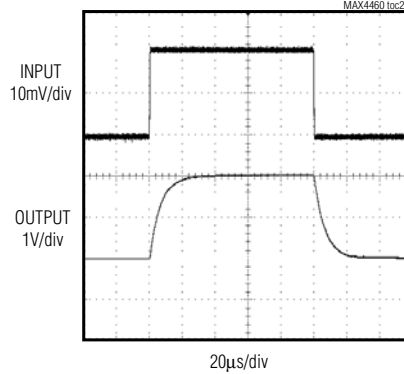

**SMALL-SIGNAL PULSE RESPONSE
(GAIN = 1V/V)**

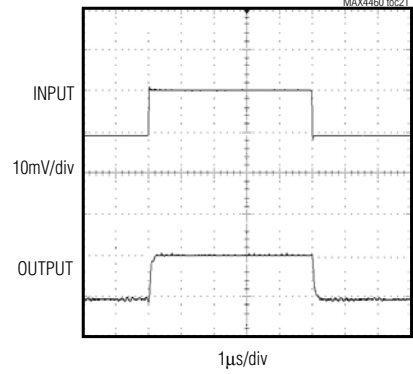

**SMALL-SIGNAL PULSE RESPONSE
(GAIN = 1V/V)**

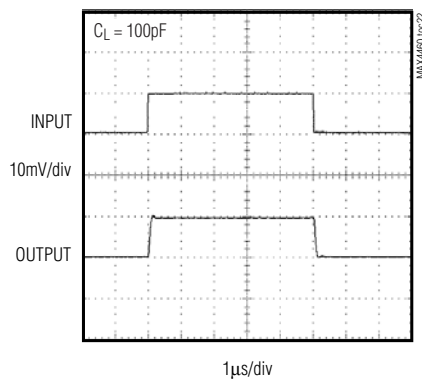

**SMALL-SIGNAL PULSE RESPONSE
(GAIN = 100V/V)**

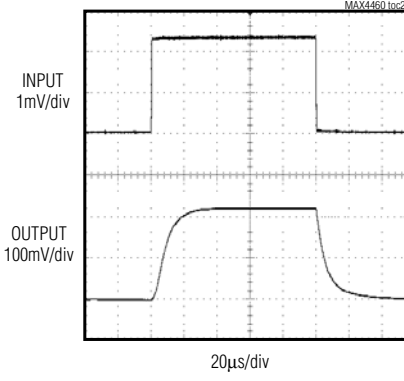

**SMALL-SIGNAL PULSE RESPONSE
(GAIN = 100V/V)**

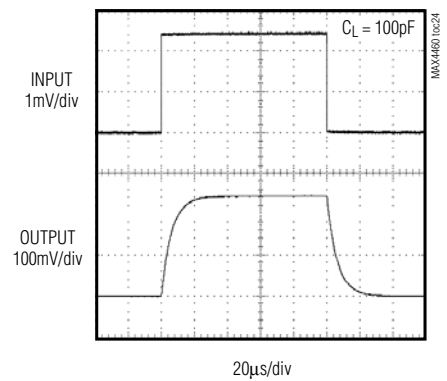

SOT23, 3V/5V, Single-Supply, Rail-to-Rail Instrumentation Amplifiers

Pin Descriptions

MAX4460/MAX4461/MAX4462

PIN		NAME	FUNCTION
MAX4460			
SOT23/TDFN	SO		
1	1	OUT	Output
2	2	GND	Negative Supply Voltage
3	3	IN+	Positive Differential Input
—	4, 5	N.C.	No Connection. Not internally connected.
4	6	IN-	Negative Differential Input
5	7	V _{DD}	Positive Supply Voltage
6	8	FB	Feedback Input. Connect FB to the center tap of a resistive divider from OUT to GND to set the gain.
EP	—	EP	Exposed Pad. TDFN only. Connect to GND.

PIN		NAME	FUNCTION
MAX4461			
SOT23/TDFN	SO		
1	1	OUT	Output
2	2	GND	Negative Supply Voltage
3	3	IN+	Positive Differential Input
—	4, 5	N.C.	No Connection. Not internally connected.
4	6	IN-	Negative Differential Input
5	7	V _{DD}	Positive Supply Voltage
6	8	$\overline{\text{SHDN}}$	Shutdown Control. Drive $\overline{\text{SHDN}}$ high for normal operation.
EP	—	EP	Exposed Pad. TDFN only. Connect to GND.

PIN		NAME	FUNCTION
MAX4462			
SOT23/TDFN	SO		
1	1	OUT	Output
2	2	V _{SS}	Negative Supply Voltage
3	3	IN+	Positive Differential Input
—	4, 5	N.C.	No Connection. Not internally connected.
4	6	IN-	Negative Differential Input
5	7	V _{DD}	Positive Supply Voltage
6	8	REF	Output Reference Level. Connect REF to an external, low-impedance reference voltage. REF sets the OUT voltage for zero differential inputs.
EP	—	EP	Exposed Pad. TDFN only. Connect to V _{SS} .

SOT23, 3V/5V, Single-Supply, Rail-to-Rail Instrumentation Amplifiers

Functional Diagrams

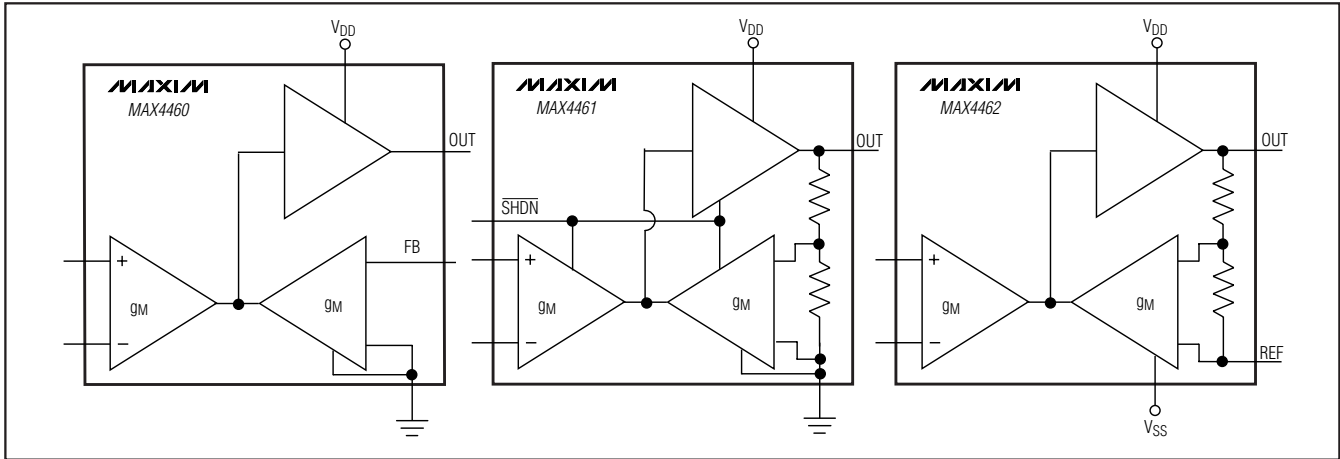

Figure 1. Functional Diagrams

Detailed Description

The MAX4460/MAX4461/MAX4462 family of instrumentation amplifiers implements Maxim's proprietary indirect current-feedback design to achieve a precision specification and excellent gain-bandwidth product. These new techniques allow ground-sensing capability combined with an ultra-low input current and an increased common-mode rejection.

The differential input signal is converted to a current by an input transconductance stage. An output transconductance stage converts a portion of the output voltage (equal to the output voltage divided by the gain) into another precision current. These two currents are subtracted and the result is fed to a loop amplifier with a class AB output stage with sufficient gain to minimize errors (Figure 1).

The MAX4461U/T/H and MAX4462U/T/H have factory-trimmed gains of 1, 10, and 100, respectively. The MAX4460 has an adjustable gain, set with an external pair of resistors between pins OUT, FB, and GND (Figure 2).

The MAX4462U/T/H has a reference input (REF) which is connected to an external reference for bipolar operation of the device. The range for V_{REF} is 0.1V to $(V_{DD} - 1.7V)$. For full output-swing capability, optimal performance is usually obtained with $V_{REF} = V_{DD}/2$.

The MAX4460/MAX4461/MAX4462 operate with single-supply voltages of 2.85V to 5.25V. It is possible to use the MAX4462U/T/H in a dual-supply configuration with up to $\pm 2.6V$ at V_{DD} and V_{SS} , with REF connected to ground.

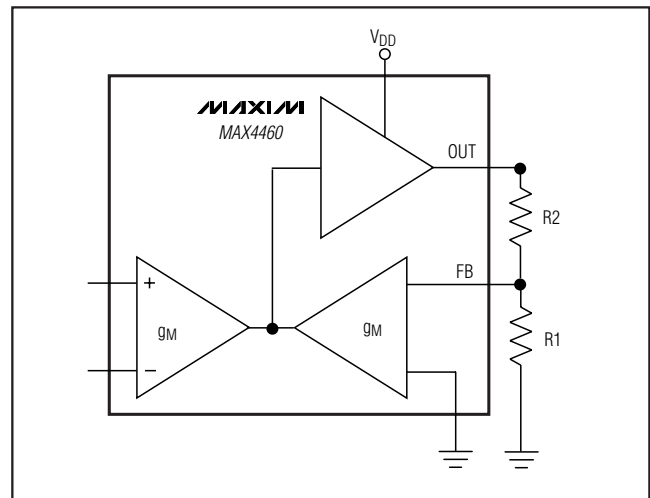

Figure 2. MAX4460 External Resistor Configuration

The MAX4461U/T/H has a shutdown feature to reduce the supply current to less than $1\mu A$. The MAX4461U/T/H output is internally referenced to ground, making the part suitable for unipolar operations.

The MAX4460 has an FB pin that can be used to externally set the gain through a pair of resistors (see *Setting the Gain* (MAX4460) section). The MAX4460 output is internally referenced to ground, making the part suitable for unipolar operations.

SOT23, 3V/5V, Single-Supply, Rail-to-Rail Instrumentation Amplifiers

MAX4460/MAX4461/MAX4462

Input Common-Mode and Output Reference Ranges

MAX4460/MAX4461/MAX4462 have an input common-mode range of 100mV below the negative supply to 1.7V below the positive supply.

The output reference voltage of MAX4462U/T/H is set by REF and ranges from 100mV above the negative supply to 1.7V below the positive supply. For maximum voltage swing in a bipolar operation, connect REF to $V_{DD}/2$.

The output voltages of the MAX4460 and MAX4461U/T/H are referenced to ground. Unlike the traditional three-op-amp configuration of common instrumentation amplifiers, the MAX4460/MAX4461/MAX4462 have ground-sensing capability (or to V_{SS} in dual-supply configuration) in addition to the extremely high input impedances of MOS input differential pairs.

Input Differential Signal Range

The MAX4460/MAX4461/MAX4462 feature a proprietary input structure optimized for small differential signals. The unipolar output of the MAX4460/MAX4461 is nominally zero-for-zero differential input. However, these devices are specified for inputs of 50mV to 100mV for the unity-gain devices, 20mV to 100mV for gain of 10 devices, and 2mV to 48mV for gain of 100 devices. The MAX4460/MAX4461 can be used with differential inputs approaching zero, albeit with reduced accuracy.

The bipolar output of the MAX4462 allows bipolar input ranges. The output voltage is equal to the reference voltage for zero differential input. The MAX4462 is specified for inputs of ± 100 mV for the unity gain and gain of 10 devices, and ± 20 mV for gain of 100 devices. The gain of 100 devices (MAX4462H) can be operated beyond 20mV signal provided the reference is chosen for unsymmetrical swing.

Output Swing

The MAX4460/MAX4461/MAX4462 are designed to have rail-to-rail output voltage swings. However, depending on the selected gain and supply voltage (and output reference level of the MAX4462), the rail-to-rail output swing is not required.

For example, consider the MAX4461U, a unity-gain device with its ground pin as the output reference level. The input voltage range is 0 to 100mV (50mV minimum to meet accuracy specifications). Because the device is unity gain and the output reference level is ground, the output only sees excursions from ground to 100mV.

Devices with higher gain and with bipolar output such as the MAX4462, can be configured to swing to higher

levels. In these cases, as the output approaches either supply, accuracy may degrade, especially under heavy output loading.

Shutdown Mode

The MAX4461U/T/H features a low-power shutdown mode. When the SHDN pin is pulled low, the internal transconductance and amplifier blocks are switched off and supply current drops to typically less than 0.1 μ A (Figure 1).

In shutdown, the amplifier output is high impedance. The output transistors are turned off, but the feedback resistor network remains connected. If the external load is referenced to GND, the output drops to approximately GND in shutdown. The output impedance in shutdown is typically greater than 100k Ω . Drive SHDN high or connect to V_{CC} for normal operation.

A User Guide to Instrumentation Amplifier Accuracy Specifications

As with any other electronic component, a complete understanding of instrumentation amplifier specifications is essential to successfully employ these devices in their application circuits. Most of the specifications for these differential closed-loop gain blocks are similar to the well-known specifications of operational amplifiers. However, there are a few accuracy specifications that could be confusing to first-time users. Therefore, some explanations and examples may be helpful.

Accuracy specifications are measurements of closeness of an actual output response to its ideal expected value. There are three main specifications in this category:

- Gain error
- Gain nonlinearity error
- Offset error

In order to understand these terms, we must look at the transfer function of an ideal instrumentation amplifier. As expected, this must be a straight line passing through origin with a slope equal to the ideal gain (Figure 3). If the ideal gain is equal to 10 and the extreme applied input voltages are -100mV and +100mV, then the value of the output voltages are -1V and +1V, respectively. Note that the line passes through the origin and therefore a zero input voltage gives a zero output response.

The transfer function of a real instrumentation amplifier is quite different from the ideal line pictured in Figure 3. Rather, it is a curve such as the one indicated as the typical curve in Figure 4, connecting end points A and B.

SOT23, 3V/5V, Single-Supply, Rail-to-Rail Instrumentation Amplifiers

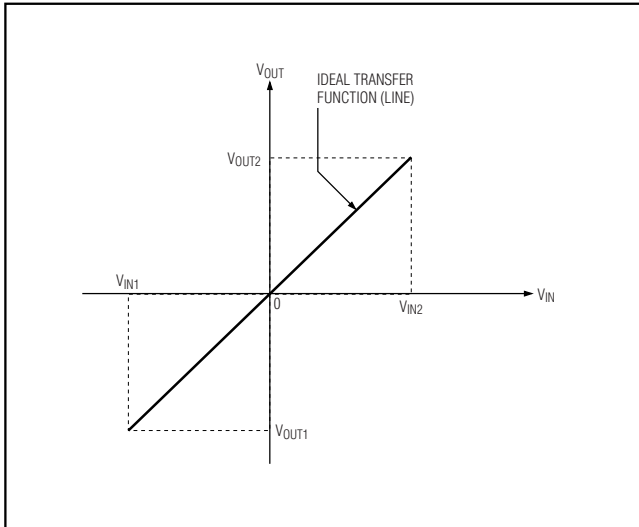

Figure 3. Transfer Function of an Ideal Instrumentation Amplifier (Straight Line Passing Through the Origin)

Looking at this curve, one can immediately identify three types of errors.

First, there is an obvious nonlinearity (curvature) when this transfer function is compared to a straight line. More deviation is measured as greater nonlinearity error. This is explained in more detail below.

Second, even if there was no nonlinearity error, i.e., the actual curve in Figure 4 was a straight line connecting end points A and B, there exists an obvious slope deviation from that of an ideal gain slope (drawn as the “ideal” line in Figure 4). This rotational error (delta slope) is a measure of how different the actual gain (G_A) is from the expected ideal gain (G_I) and is called gain error (GE) (see the equation below).

Third, even if the actual curve between points A and B was a straight line (no nonlinearity error) and had the same slope as the ideal gain line (no gain error), there is still another error called the end-point offset error (OE on vertical axis), since the line is not passing through the origin.

Figure 5 is the same as Figure 4, but the ideal line (CD) is shifted up to pass through point E (the Y intercept of end-points line AB).

This is done to better visualize the rotational error (GE), which is the difference between the slopes of end points line AB and the shifted ideal line CD.

Mathematically:

$$GE (\%) = 100 \times (G_A - G_I) / G_I$$

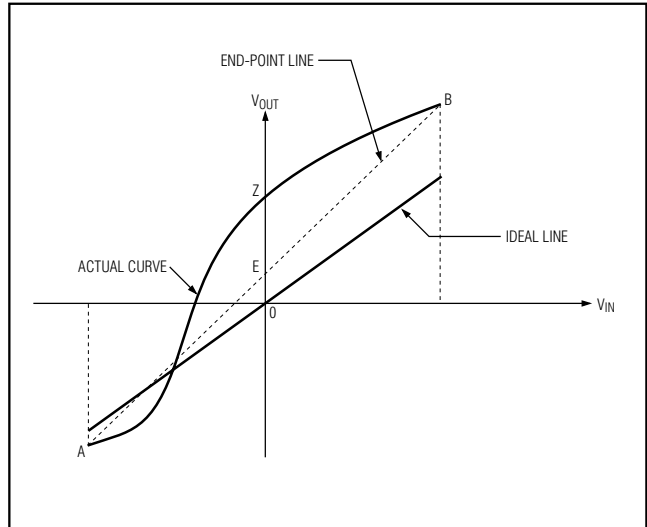

Figure 4. Typical Transfer Function for a Real Instrumentation Amplifier

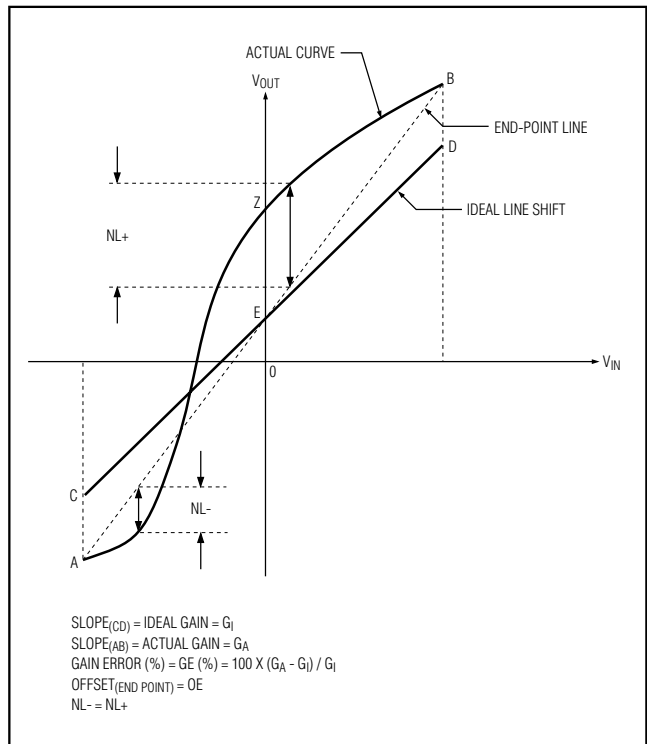

Figure 5. Typical Transfer Function for a Real Instrumentation Amplifier (Ideal Line (CD) Is Shifted by the End-Points Offset (OE) to Visualize Gain Error)

SOT23, 3V/5V, Single-Supply, Rail-to-Rail Instrumentation Amplifiers

MAX4460/MAX4461/MAX4462

The rotational nature of gain error, and the fact that it is pivoted around point E in Figure 5, shows that gain-error contribution to the total output voltage error is directly proportional to the input voltage. At zero input voltage, the error contribution of gain error is zero, i.e., the total deviation from the origin (the expected zero output value) is only due to end-points OE and nonlinearity error at zero value of input (segment EZ on the vertical axis).

The nonlinearity is the maximum deviation from a straight line, and the end-point nonlinearity is the deviation from the end-point line. As shown in Figure 5, it is likely that two nonlinearities are encountered, one positive and the other a negative nonlinearity error, shown as NL+ and NL- in Figure 5.

Generally, NL+ and NL- have different values and this remains the case if the device is calibrated (trimmed) for end-points errors (which means changing the gain of the instrumentation amplifier in such a way that the slope of line AB becomes equal to that of CD, and the offset becomes trimmed such that OE vanishes to zero). This is an undesirable situation when nonlinearity is of prime interest.

The straight line shown in Figure 6 is in parallel to end-points line AB and has a Y intercept of OS on the vertical axis. This line is a shifted end-points line such that the positive and negative nonlinearity errors with respect to this line are equal. For this reason, the line is called the best straight line (BSL). Maxim internally trims the MAX4460/MAX4461/MAX4462 with respect to this line (changing the gain slope to be as close as possible to the slope of the ideal line and trimming the offset such that OS gets as close to the origin as possible) to minimize all the errors. The total accuracy error is still the summation of the gain error, nonlinearity, and offset errors.

As an example, assume the following specification for an instrumentation amplifier:

- Gain = 10
- GE = 0.15%
- Offset (BSL) = 250µV
- NL = 0.05%
- V_{DIF} (input) = -100mV to +100mV

What is the maximum total error associated with the GE, offset (BSL), and NL? With a differential input range of -0.1V to +0.1V and a gain of 10, the output voltage assumes a range of -1V to +1V, i.e., a total full-scale range of 2V.

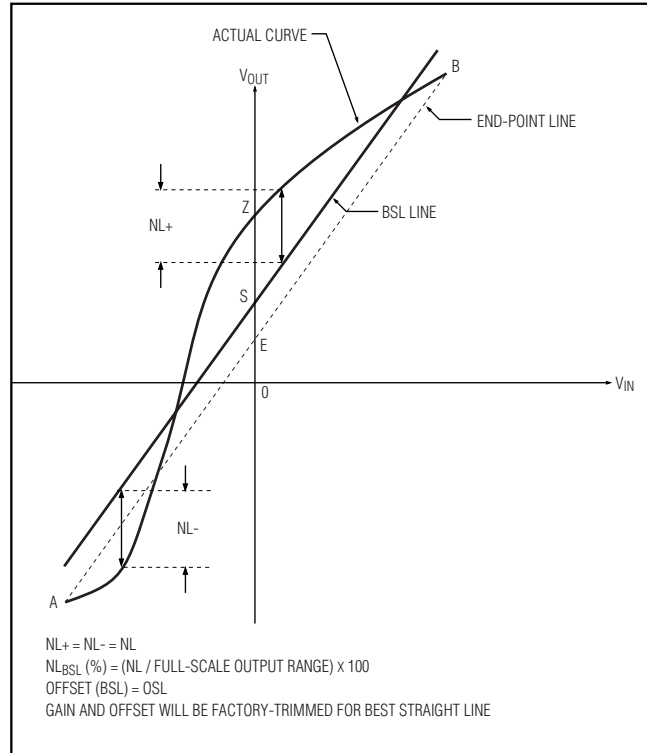

Figure 6. To Minimize Nonlinearity Error, the MAX4460/MAX4461/MAX4462 are Internally Trimmed to Adjust Gain and Offset for the Best Straight Line so $NL_- = NL_+$

The individual errors are as follows:

$$\begin{aligned}
 GE &= (0.15\%) (10) (100\text{mV}) = 1.5\text{mV} \\
 \text{Offset (BSL)} &= (250\mu\text{V}) (10) = 2.5\text{mV} \\
 NL &= (0.05\%) (2\text{V}) = 1\text{mV} \\
 \text{Maximum Total Error} &= 1.5\text{mV} + 2.5\text{mV} + 1\text{mV} \\
 &= 5\text{mV}
 \end{aligned}$$

So, the absolute value of the output voltage, considering the above errors, would be at worst case between 0.995V to 1.005V. Note that other important parameters such as PSRR, CMRR, and noise also contribute to the total error in instrumentation applications. They are not considered here.

SOT23, 3V/5V, Single-Supply, Rail-to-Rail Instrumentation Amplifiers

Applications Information

Setting the Gain (MAX4460)

The MAX4460 gain is set by connecting a resistive-divider from OUT to GND, with the center tap connected to FB (Figure 2). The gain is calculated by:

$$\text{Gain} = 1 + R2 / R1$$

Because FB has less than 100pA IB, high-valued resistors can be used without significantly affecting the gain accuracy. The sum of resistors (R1 + R2) near 100kΩ is a good compromise. Resistor accuracy directly affects gain accuracy. Resistor sum less than 20kΩ should not be used because their loading can slightly affect output accuracy.

Capacitive-Load Stability

The MAX4460/MAX4461/MAX4462 are capable of driving capacitive loads up to 100pF.

Applications needing higher capacitive drive capability may use an isolation resistor between OUT and the load to reduce ringing on the output signal. However this reduces the gain accuracy due to the voltage drop across the isolation resistor.

Output Loading

For best performance, the output loading should be to the potential seen at REF for the MAX4462 or to ground for the MAX4460/MAX4461.

REF Input (MAX4462)

The REF input of the MAX4462 can be connected to any voltage from (V_{SS} + 0.1V) to (V_{DD} - 1.7V). A buffered voltage-divider with sink and source capability works well to center the output swing at V_{DD}/2. Unbuffered resistive dividers should be avoided because the 100kΩ (typ) input impedance of REF causes amplitude-dependent variations in the divider's output.

Bandgap references, either series or shunt, can be used to drive REF. This provides a voltage and temperature invariant reference. This same reference voltage can be used to bias bridge sensors to eliminate supply voltage ratiometricity. For proper operation, the reference must be able to sink and source at least 25μA.

In many applications, the MAX4462 is connected to a CODEC or other device with a reference voltage output. In this case, the receiving device's reference output makes an ideal reference voltage. Verify the reference output of the device is capable of driving the MAX4462's REF input.

Power-Supply Bypass and Layout

Good layout technique optimizes performance by decreasing the amount of stray capacitance at the instrumentation amplifier's gain-setting pins. Excess capacitance produces peaking in the amplifier's frequency response. To decrease stray capacitance, minimize trace lengths by placing external components as close to the instrumentation amplifier as possible. For best performance, bypass each power supply to ground with a separate 0.1μF capacitor.

Microphone Amplifier

The MAX4462's bipolar output, along with its excellent common-mode rejection ratio, makes it suitable for precision microphone amplifier applications. Figure 7 illustrates one such circuit. In this case, the electret microphone is resistively biased to the supply voltage through a 2.2kΩ pullup resistor. The MAX4462 directly senses the output voltage at its noninverting input, and indirectly senses the microphone's ground through an AC-coupling capacitor. This technique provides excellent rejection of common-mode noise picked up by the microphone lead wires. Furthermore, ground noise from distantly located microphones is reduced.

The single-ended output of the MAX4462 is converted to differential through a single op amp, the MAX4335. The op amp forces the midpoint between OUT+ and OUT- to be equal to the reference voltage. The configuration does not change the MAX4462's fixed gain of 10.

SOT23, 3V/5V, Single-Supply, Rail-to-Rail Instrumentation Amplifiers

MAX4460/MAX4461/MAX4462

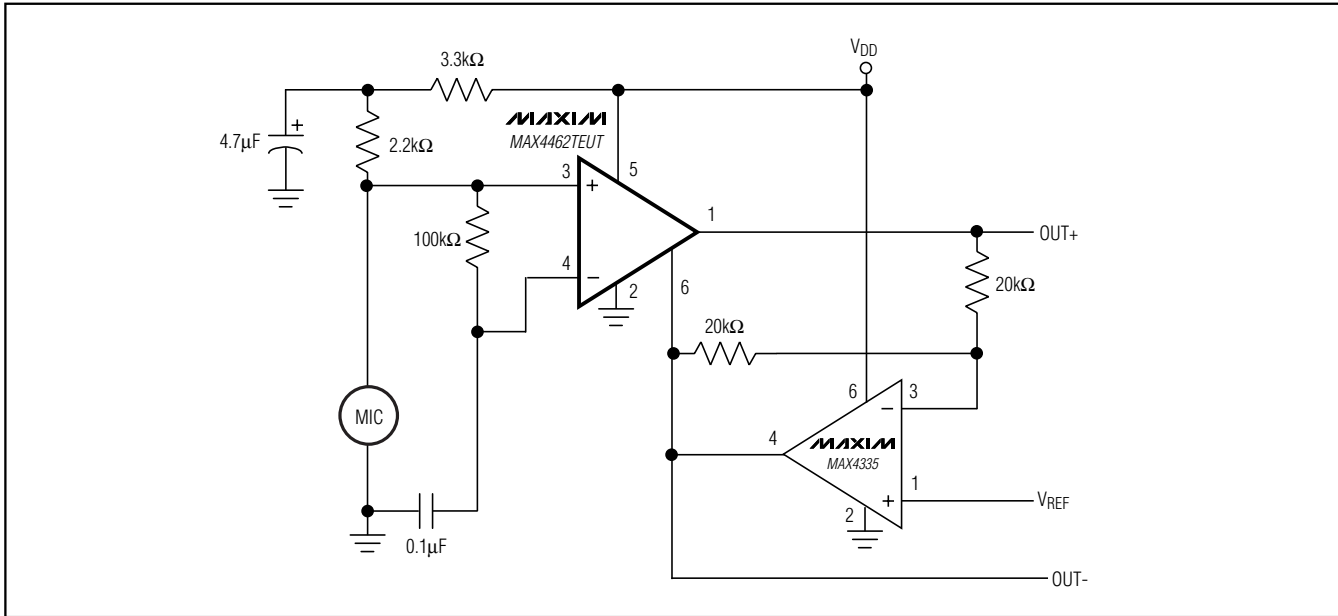
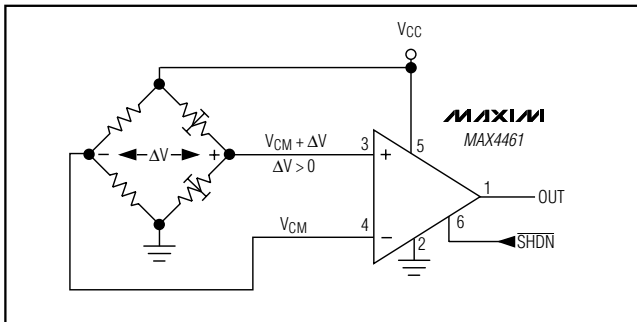

Figure 7. Differential I/O Microphone Amplifier

Typical Application Circuits (continued)



Selector Guide

PART	GAIN	REF	SHUTDOWN
MAX4460	Adjustable	GND	NO
MAX4461U	1	GND	YES
MAX4461T	10	GND	YES
MAX4461H	100	GND	YES
MAX4462U	1	EXT	NO
MAX4462T	10	EXT	NO
MAX4462H	100	EXT	NO

Ordering Information (continued)

PART	TEMP RANGE	PIN-PACKAGE	TOP MARK
MAX4462UETT+T	-40°C to +85°C	6 TDFN-EP*	+ANM
MAX4462UEUT-T	-40°C to +85°C	6 SOT23-6	AASW
MAX4462UESA	-40°C to +85°C	8 SO	—
MAX4462TETT+T	-40°C to +85°C	6 TDFN-EP*	+ANN
MAX4462TEUT-T	-40°C to +85°C	6 SOT23-6	AASX
MAX4462TESA	-40°C to +85°C	8 SO	—
MAX4462HETT+T	-40°C to +85°C	6 TDFN-EP*	+ANO
MAX4462HEUT-T	-40°C to +85°C	6 SOT23-6	AASY
MAX4462HESA	-40°C to +85°C	8 SO	—

+Denotes lead-free package.

*EP = Exposed paddle.

Chip Information

TRANSISTOR COUNT: 421

PROCESS: BiCMOS

SOT23, 3V/5V, Single-Supply, Rail-to-Rail Instrumentation Amplifiers

Pin Configurations

TOP VIEW

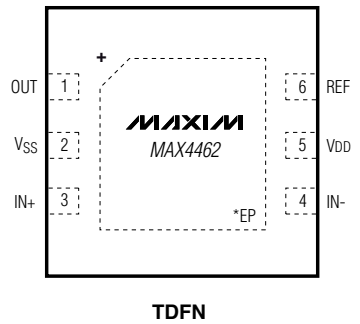
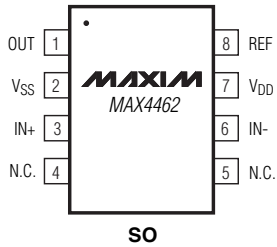
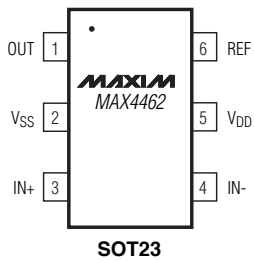
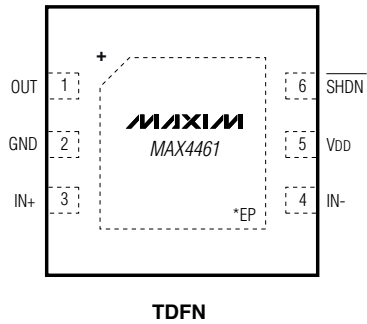
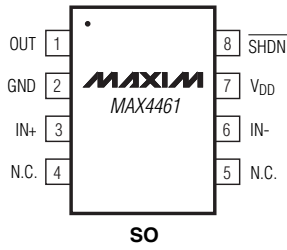
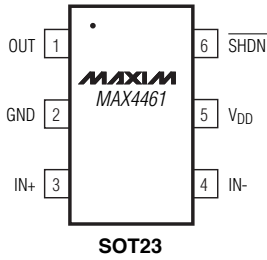
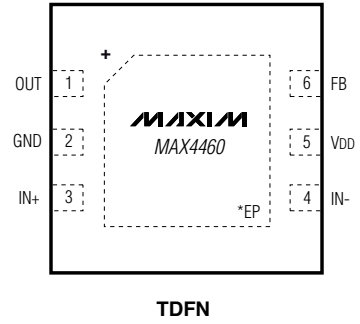
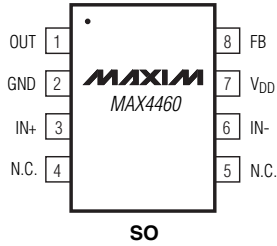
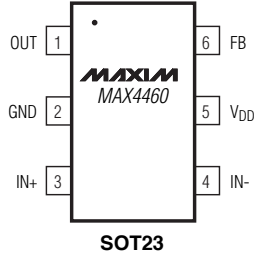

+ DENOTES LEAD-FREE PACKAGING

SOT23, 3V/5V, Single-Supply, Rail-to-Rail Instrumentation Amplifiers

Package Information

(The package drawing(s) in this data sheet may not reflect the most current specifications. For the latest package outline information, go to www.maxim-ic.com/packages.)

MAX4460/MAX4461/MAX4462

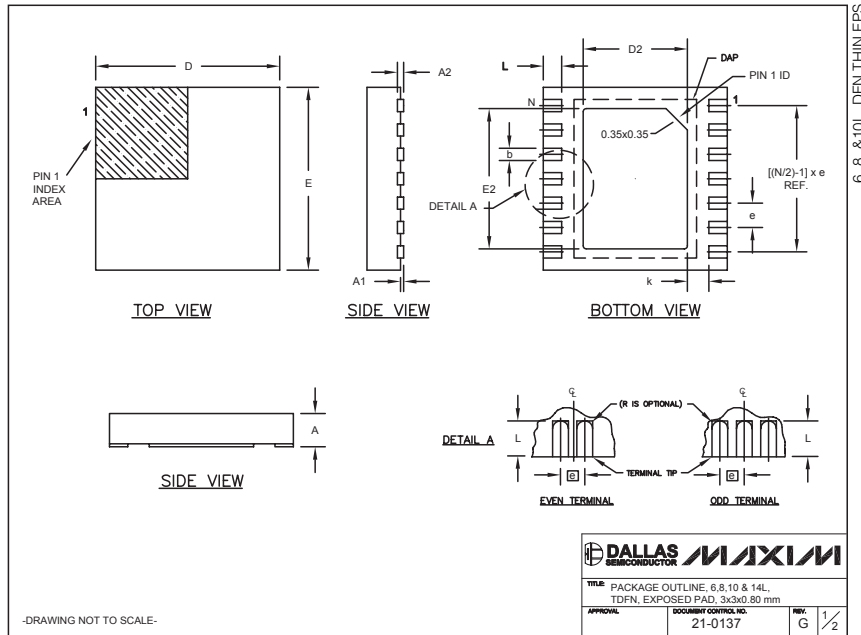

COMMON DIMENSIONS							
SYMBOL	MIN	MAX					
A	0.70	0.80					
D	2.90	3.10					
E	2.90	3.10					
A1	0.00	0.05					
L	0.20	0.40					
k	0.25 MIN.						
A2	0.20 REF.						

PACKAGE VARIATIONS								
PKG. CODE	N	D2	E2	e	JEDEC SPEC	b	[(N/2)-1] x e	DOWNBONDS ALLOWED
T633-1	6	1.50±0.10	2.30±0.10	0.95 BSC	MO229 / WEEA	0.40±0.05	1.90 REF	NO
T633-2	6	1.50±0.10	2.30±0.10	0.95 BSC	MO229 / WEEA	0.40±0.05	1.90 REF	NO
T833-1	8	1.50±0.10	2.30±0.10	0.65 BSC	MO229 / WEEC	0.30±0.05	1.95 REF	NO
T833-2	8	1.50±0.10	2.30±0.10	0.65 BSC	MO229 / WEEC	0.30±0.05	1.95 REF	NO
T833-3	8	1.50±0.10	2.30±0.10	0.65 BSC	MO229 / WEEC	0.30±0.05	1.95 REF	YES
T1033-1	10	1.50±0.10	2.30±0.10	0.50 BSC	MO229 / WEEED-3	0.25±0.05	2.00 REF	NO
T1433-1	14	1.70±0.10	2.30±0.10	0.40 BSC	----	0.20±0.05	2.40 REF	YES
T1433-2	14	1.70±0.10	2.30±0.10	0.40 BSC	----	0.20±0.05	2.40 REF	NO

NOTES:

- ALL DIMENSIONS ARE IN mm. ANGLES IN DEGREES.
- COPLANARITY SHALL NOT EXCEED 0.08 mm.
- WARPAGE SHALL NOT EXCEED 0.10 mm.
- PACKAGE LENGTH/PACKAGE WIDTH ARE CONSIDERED AS SPECIAL CHARACTERISTIC(S).
- DRAWING CONFORMS TO JEDEC MO229, EXCEPT DIMENSIONS "D2" AND "E2", AND T1433-1 & T1433-2.
- "N" IS THE TOTAL NUMBER OF LEADS.
- NUMBER OF LEADS SHOWN ARE FOR REFERENCE ONLY.

DALLAS SEMICONDUCTOR MAXIM

TITLE PACKAGE OUTLINE: 6, 8, 10 & 14L, TDFN, EXPOSED PAD, 3x3x0.80 mm

APPROVAL DOCUMENT CONTROL NO. 21-0137 REV. G 2/2

-DRAWING NOT TO SCALE-

Note: MAX446_ _ETT+T uses TDFN package option T633-2.

SOT23, 3V/5V, Single-Supply, Rail-to-Rail Instrumentation Amplifiers

Package Information (continued)

(The package drawing(s) in this data sheet may not reflect the most current specifications. For the latest package outline information, go to www.maxim-ic.com/packages.)

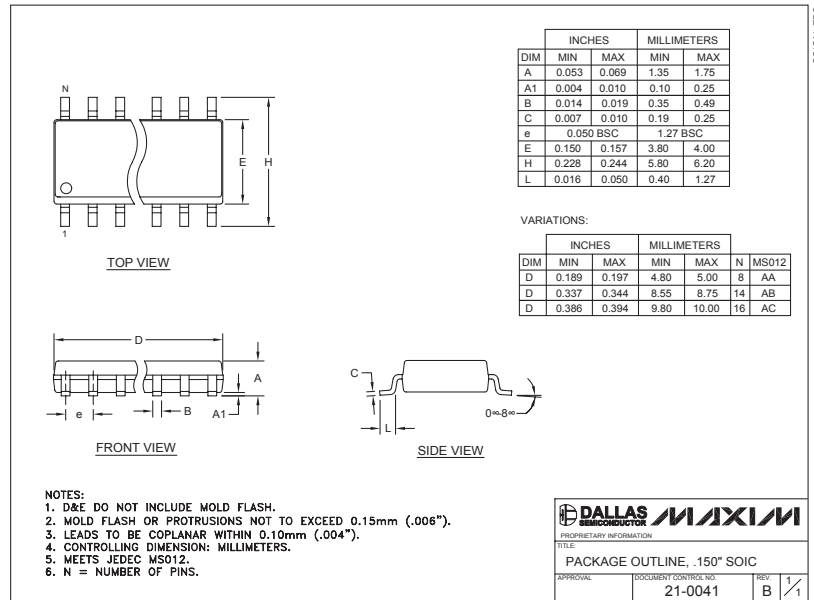
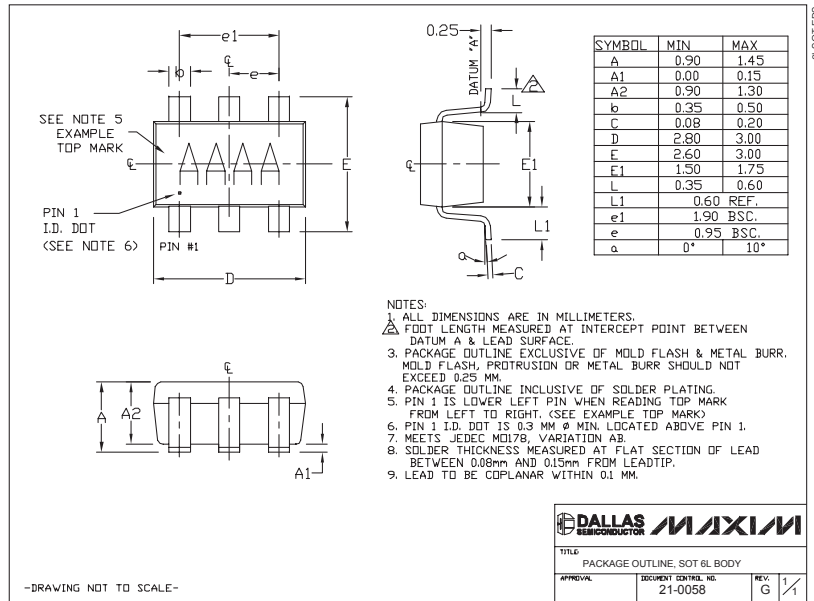

Maxim cannot assume responsibility for use of any circuitry other than circuitry entirely embodied in a Maxim product. No circuit patent licenses are implied. Maxim reserves the right to change the circuitry and specifications without notice at any time.

20 **Maxim Integrated Products, 120 San Gabriel Drive, Sunnyvale, CA 94086 408-737-7600**

Данный компонент на территории Российской Федерации

Вы можете приобрести в компании MosChip.

Для оперативного оформления запроса Вам необходимо перейти по данной ссылке:

<http://moschip.ru/get-element>

Вы можете разместить у нас заказ для любого Вашего проекта, будь то серийное производство или разработка единичного прибора.

В нашем ассортименте представлены ведущие мировые производители активных и пассивных электронных компонентов.

Нашей специализацией является поставка электронной компонентной базы двойного назначения, продукции таких производителей как XILINX, Intel (ex.ALTERA), Vicor, Microchip, Texas Instruments, Analog Devices, Mini-Circuits, Amphenol, Glenair.

Сотрудничество с глобальными дистрибьюторами электронных компонентов, предоставляет возможность заказывать и получать с международных складов практически любой перечень компонентов в оптимальные для Вас сроки.

На всех этапах разработки и производства наши партнеры могут получить квалифицированную поддержку опытных инженеров.

Система менеджмента качества компании отвечает требованиям в соответствии с ГОСТ Р ИСО 9001, ГОСТ РВ 0015-002 и ЭС РД 009

Офис по работе с юридическими лицами:

105318, г.Москва, ул.Щербаковская д.3, офис 1107, 1118, ДЦ «Щербаковский»

Телефон: +7 495 668-12-70 (многоканальный)

Факс: +7 495 668-12-70 (доб.304)

E-mail: info@moschip.ru

Skype отдела продаж:

moschip.ru

moschip.ru_4

moschip.ru_6

moschip.ru_9