

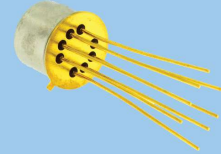

## TO-5 RELAYS ESTABLISHED RELIABILITY MILITARY DPDT



SERIES	RELAY TYPE
412	DPDT basic relay
412D	DPDT relay with internal diode for coil transient suppression
412DD	DPDT relay with polarity reversal protection and coil transient suppression diode
412T	DPDT relay with internal transistor driver and coil transient suppression diode

### DESCRIPTION

The TO-5 relay, originally conceived and developed by Teledyne, has become one of the industry standards for low-level switching from dry circuit to 1 ampere. Designed expressly for high-density PC board mounting, its small size and low coil power dissipation make the 412 relay one of the most versatile ultraminiature relays available.

The following unique construction features and manufacturing techniques provide excellent resistance to environmental extremes and overall high reliability.

#### The 412 feature:

- All welded construction.
- Unique uni-frame design providing high magnetic efficiency and mechanical rigidity.
- High force/mass ratios for resistance to shock and vibration.

- Advanced cleaning techniques provide maximum assurance of internal cleanliness.
- Precious metal alloy contact material with gold plating assures excellent high current and dry circuit switching capabilities.

The Series 412D and 412DD relays have internal discrete silicon diodes for coil suppression and polarity reversal protection. The hybrid 412T relay features an internal silicon suppression diode and transistor driver. This hybrid package reduces required PC board floor space by reducing the number of external components needed to drive the relay.

By virtue of its inherently low intercontact capacitance and contact circuit losses, the 412 relay has proven to be an excellent ultraminiature RF switch for frequency ranges well into the UHF spectrum. A typical RF application for the TO-5 relay is in handheld radio transceivers, wherein the combined features of good RF performance, small size, low coil power dissipation and high reliability make it a preferred method of T-R switching

### ENVIRONMENTAL AND PHYSICAL SPECIFICATIONS

<b>Temperature</b> (Ambient)	-65°C to +125°C
<b>Vibration</b> (General Note I)	30 g's to 3000 Hz
<b>Shock</b> (General Note I)	75 g's, 6ms half sine
<b>Acceleration</b>	50 g's
<b>Enclosure</b>	Hermetically sealed
<b>Weight</b>	0.09 oz. (2.55g) max.

### INTERNAL CONSTRUCTION

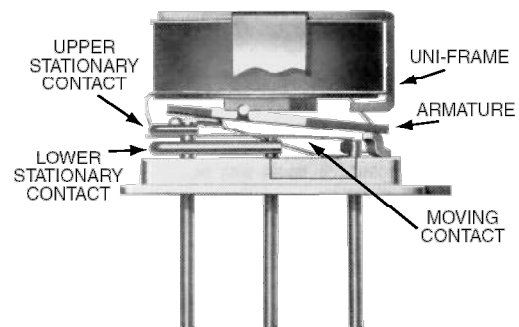

**SERIES 412**  
**GENERAL ELECTRICAL SPECIFICATIONS (-65°C to +125°C unless otherwise noted) (Notes 2 & 3)**

<b>Contact Arrangement</b>	2 Form C (DPDT)		
<b>Rated Duty</b>	Continuous		
<b>Contact Resistance</b>	0.1 ohm max. before life; 0.2 ohm max. after life at 1A/28Vdc (measured 1/8" from header)		
<b>Contact Load Rating (DC)</b>	Resistive: 1 A / 28 Vdc Inductive: 200 mA / 28 Vdc (320mH) Lamp: 100 mA / 28 Vdc (320mH) Low level: 10 to 50 $\mu$ A @ 10 to 50 mV		
<b>Contact Load Rating (AC)</b>	Resistive: 250 mA / 115Vac, 60 and 400 Hz (Case not grounded) 100 mA / 115 Vac, 60 and 400 Hz (Case grounded)		
<b>Contact Life Ratings</b>	10,000,000 cycles (typical) at low level 1,000,000 cycles (typical) at 0.5 A / 28 Vdc resistive 100,000 cycles min. at all other loads specified above		
<b>Contact Overload Rating</b>	2 A / 28 Vdc Resistive (100 cycles min.)		
<b>Coil Operating Power</b>	450 mW typical at nominal rated voltage		
<b>Contact Carry Rating</b>	Contact Factory		
<b>Operate Time</b>	2.0 ms max. at nominal rated coil voltage		
<b>Release Time</b>	412: 1.5 ms max.	412D, 412DD: 4.0 ms max.	412T: 7.5 ms max
<b>Contact Bounce</b>	1.5 ms max		
<b>Intercontact Capacitance</b>	0.4 pf typical		
<b>Insulation Resistance</b>	10,000 M $\Omega$ min. between mutually isolated terminals		
<b>Dielectric Strength</b>	500 Vrms / 60 Hz @ atmospheric pressure		
	125 Vrms / 60 Hz @ 70,000 ft		
<b>Negative Coil Transient (Vdc)</b> 412D, 412DD, 412T	1.0 Vdc Max.		
<b>Diode P.I.V. (Vdc)</b> 412D, 412DD, 412T	100 Vdc Min.		
<b>412T Transistor Characteristics</b>	Base Voltage to Turn Off (Vdc)		0.3 min
	Emitter-Base breakdown Voltage ( $BV_{EBO}$ ) (@25°C) (Vdc)		6.0 min
	Collector-Base breakdown Voltage ( $BV_{CBO}$ ) (@25°C & $I_c = 100 \mu$ A) (Vdc)		75 min

**412 Series**

**DETAILED ELECTRICAL SPECIFICATIONS (-65°C to +125°C unless otherwise noted) (Notes 3)**

BASE PART NUMBERS (412, 412D, 412DD, 412T)		412-5 412D-5 412DD-5 412T-5	412-12 412D-12 412DD-12 412T-12	412-26 412D-26 412DD-26 412T-26
Coil Voltage	Nom.	5.0	12.0	26.5
	Max.	5.8	16.0	32.0
Coil Resistance (Ohms ±10% @25°C)	412, 412D, 412T	50	390	1560
	412DD	39	390	1560
Coil Current (412DD) (mAdc@25°C)	Min.	93.2	25.6	14.8
	Max.	128.2	32.8	18.5
Coil Current (412T) (mAdc@25°C) (Note 7)	Min.	82.2	26.6	14.7
	Max.	112.1	35.8	19.8
Pick-up Voltage (Vdc, Max)	412, 412D	3.5	9.0	18.0
	412DD	3.9	10.0	19.0
	412T (Note 7)	3.5	9.0	18.0
Drop-out Voltage (Vdc)	412, 412D, 412T	Min.	0.14	0.41
		Max.	2.3	6.5
	412DD	Min.	0.6	0.9
		Max.	2.8	6.5

**PERFORMANCE CURVES (Note 2)**

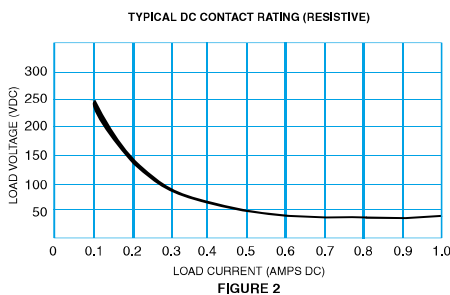
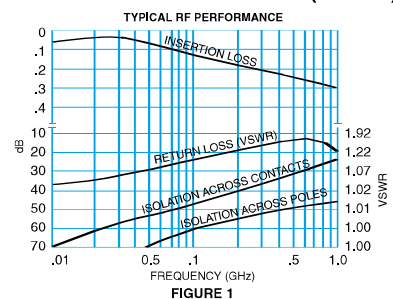

**GENERAL NOTES**

1. Relay contacts will exhibit no chatter in excess of 10 µsec or transfer in excess of 1 µsec.
2. "Typical" characteristics are based on available data and are best estimates. No on-going verification tests are performed.
3. Unless otherwise specified, parameters are initial values.
4. Relays can be supplied with a spacer pad. See appendix.

**SERIES 412  
OUTLINE DIMENSIONS**

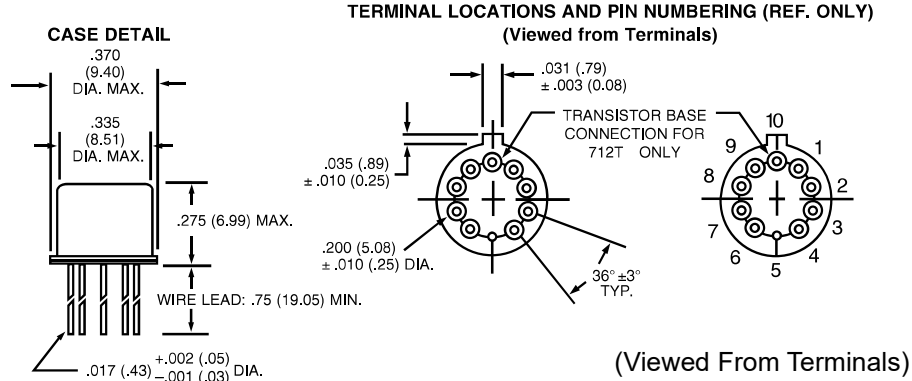

**SCHEMATIC DIAGRAMS**

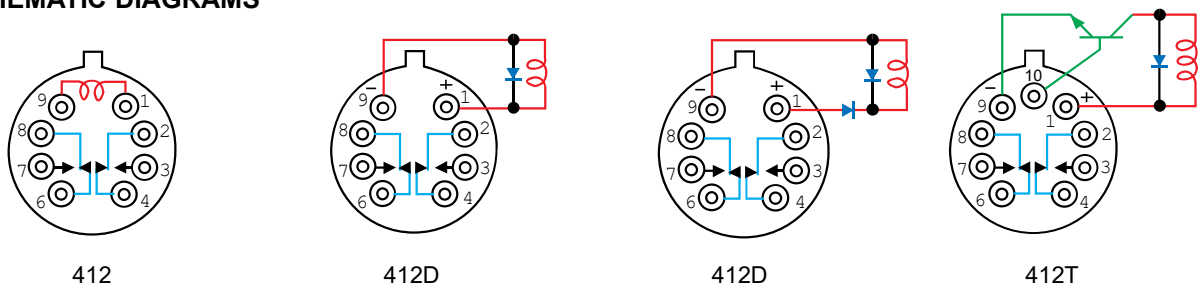

**TYPICAL LOGIC INTERFACE**  
(See Note 8)

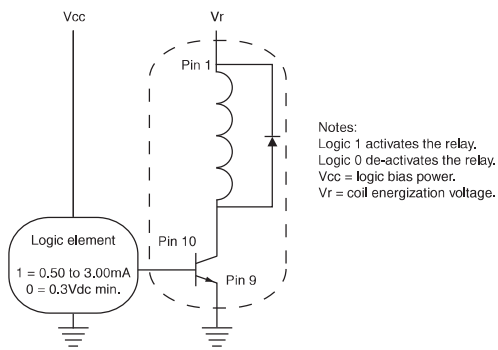

**SERIES 412  
PART NUMBERING SYSTEM**

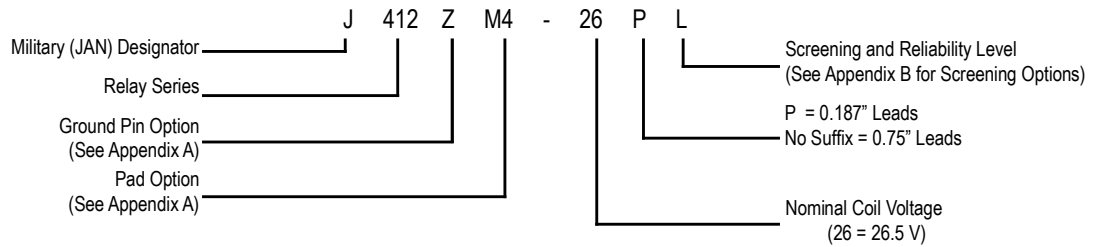
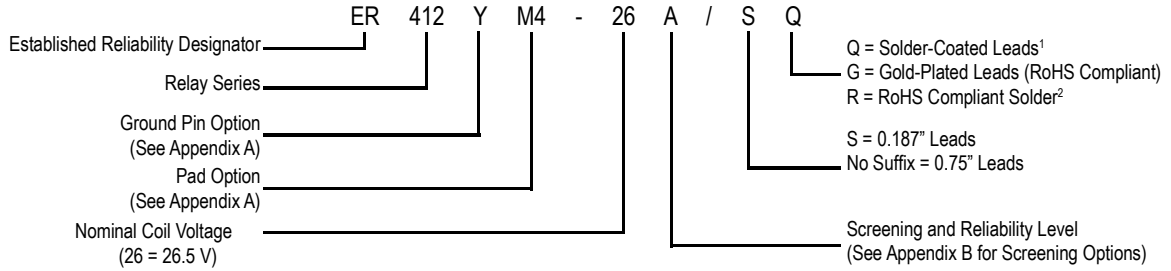

**NOTES:**

1. RELAY CONTACTS WILL EXHIBIT NO CHATTER IN EXCESS OF 10 MSEC OR TRANSFER IN EXCESS OF 1 MSEC.
2. "TYPICAL" CHARACTERISTICS ARE BASED ON AVAILABLE DATA AND ARE BEST ESTIMATES. NO ON-GOING VERIFICATION TESTS ARE PERFORMED.
3. UNLESS OTHERWISE SPECIFIED, PARAMETERS ARE INITIAL VALUES.
4. FOR REFERENCE ONLY. COIL RESISTANCE NOT DIRECTLY MEASURABLE AT RELAY TERMINALS DUE TO INTERNAL SERIES SEMICONDUCTOR. 412DD AND 412T ONLY.
5. UNLESS OTHERWISE SPECIFIED, RELAYS WILL BE SUPPLIED WITH EITHER GOLD-PLATED OR SOLDER-COATED LEADS.
6. THE SLASH AND CHARACTERS APPEARING AFTER THE SLASH ARE NOT MARKED ON THE RELAY.
7. LIMIT BASE EMITTER CURRENT TO 15 mADC.
8. APPLICABLE TO ALL COIL VOLTAGES. SEE BASE CURRENT TO TURN ON.
9. SCREENED HI-REL VERSIONS AVAILABLE. CONTACT FACTORY.

## APPENDIX A : Spacer Pads

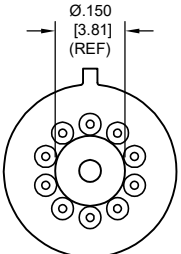
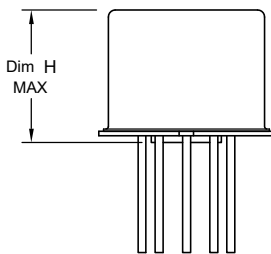
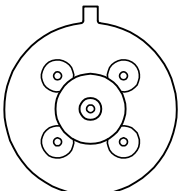
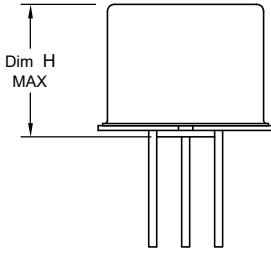
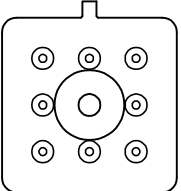
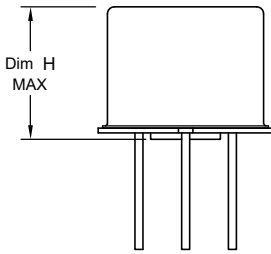
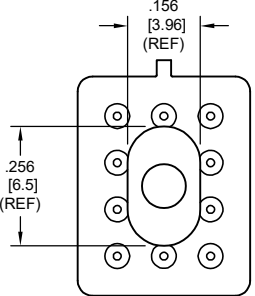
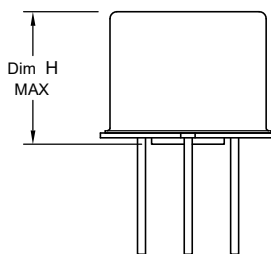
Pad designation and bottom view dimensions	Height	For use with the following:	Dim. H Max.
 <p style="text-align: center;">“M4” Spacer Pad for TO-5</p>		ER412	.295 (7.49)
		712, RF300, RF, RF700, RF703	.300 (7.62)
		ER422, 722	.305 (7.75)
		ER432	.400 (10.16)
		732, RF303	.410 (10.41)
		RF312	.350 (8.89)
 <p style="text-align: center;">“M4” Spacer Pad for TO-5</p>		ER411	.295 (7.49)
		RF311	.300 (7.62)
		RF331	.410 (10.41)
 <p style="text-align: center;">“M4” Spacer Pad for Centigrid®</p>		172	.305 (7.75)
		ER114, J114	.300 (7.62)
		ER134, J134	.400 (10.16)
		RF100	.315 (8.00)
		RF103	.420 (10.67)
 <p style="text-align: center;">“M9” Spacer Pad for Centigrid®</p>		122C, A152	.320 (8.13)
		ER116C, J116C	.300 (7.62)
		ER136C, J136C	.400 (10.16)
		RF180	.325 (8.25)
		A150	.305 (7.75)

**Notes:**

1. Spacer pad material: Polyester film.
2. To specify an “M4” or “M9” spacer pad, refer to the mounting variants portion of the part numbering example in the applicable datasheet.
3. Dimensions are in inches (mm).
4. Unless otherwise specified, tolerance is  $\pm .010$  (.25 mm).
5. Add 10 m $\Omega$  to the contact resistance shown in the datasheet.
6. Add 0.01 oz. (0.25 g) to the weight of the relay assembly shown in the datasheet.

## APPENDIX A : Spreader Pads

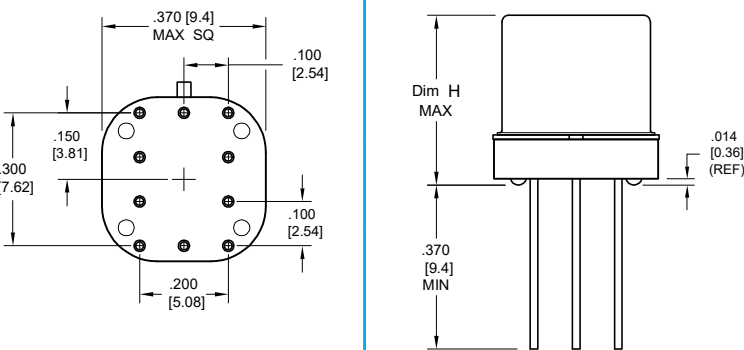
Pad designation and bottom view dimensions	Height	For use with the following:	Dim. H Max.
 <p style="text-align: center;">"M" Spreader Pad <u>5/</u> <u>6/</u></p>		ER411T, ER412, J412	.388 (9.86)
		712	.393 (9.99)
		ER432, J432	.493 (12.52)
		732	.503 (12.78)
		J421, J422, ER422, 722	.398 (10.11)

**Notes:**

1. Spreader pad material: Diallyl Phthalate.
2. To specify an "M", "M2" or "M3" spreader pad, refer to the mounting variants portion of the part number example in the applicable datasheet.
3. Dimensions are in inches (mm).
4. Unless otherwise specified, tolerance is  $\pm .010$ " (0.25 mm).
- 5/. Add 25 m $\Omega$  to the contact resistance shown in the datasheet.
- 6/. Add .01 oz. (0.25 g) to the weight of the relay assembly shown in the datasheet.
- 7/. Add 50 m $\Omega$  to the contact resistance shown in the datasheet.
- 8/. Add 0.025 oz (0.71 g) to the weight of the relay assembly shown in the datasheet.
- 9/. M3 pad to be used only when the relay has a center pin (e.g. ER411M3-12A, 722XM3-26.)

# APPENDIX A : Ground Pin Positions

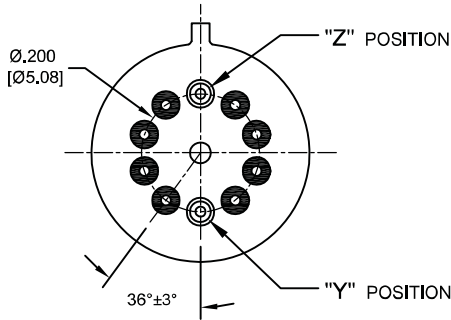

### TO-5 Relays:

ER412, ER412T, ER422, ER432, ER432T, 712, 712TN, 400H, 400K, 400V, RF300, RF303, RF341, RF312, RF332, RF310, RF313, RF320, RF323, SI800, SI803, RF700, RF703

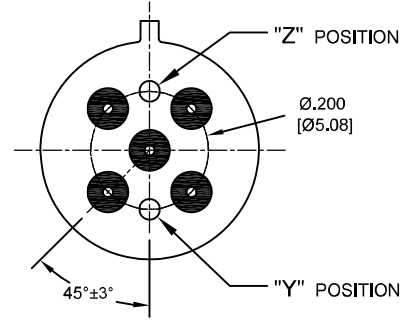

### TO-5 Relays:

ER411, RF311, RF331

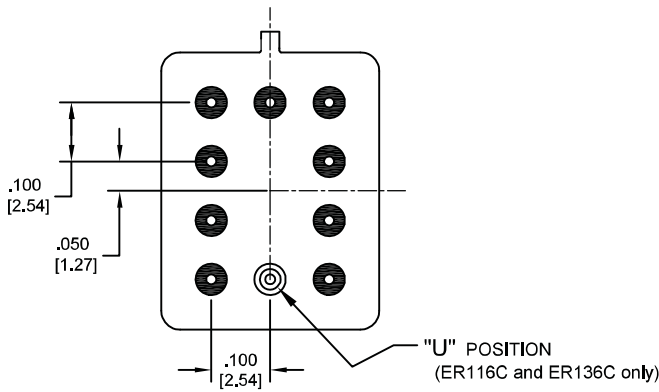

### Centigrad® Relays:

RF180, ER116C, 122C, ER136C

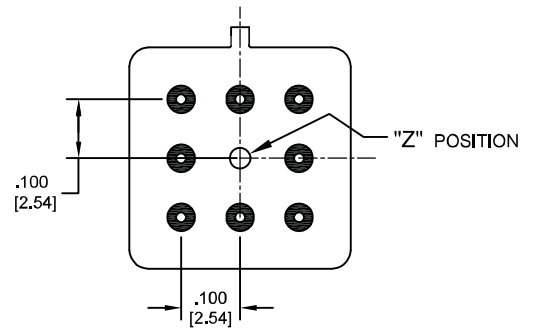

### Centigrad® Relays:

RF100, RF103, ER114, ER134, 172

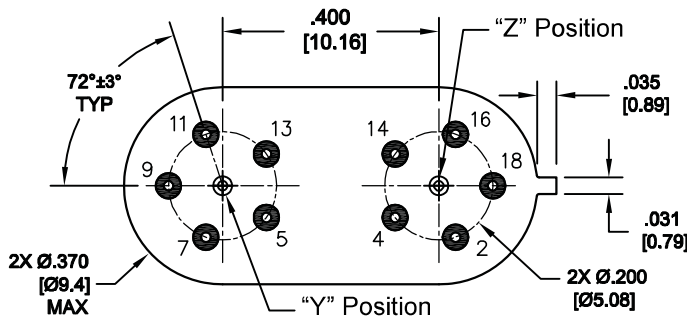

### Loopback Relays:

LB363

### NOTES

- Indicates ground pin position
- Indicates glass insulated lead position
- ◎ Indicates ground pin or lead position depending on relay type

1. Terminal views shown
2. Dimensions are in inches (mm)
3. Tolerances:  $\pm .010$  ( $\pm .25$ ) unless otherwise specified
4. Ground pin positions are within  $.015$  ( $0.38$ ) dia. of true position
5. Ground pin head dia.,  $0.035$  ( $0.89$ ) ref: height  $0.010$  ( $0.25$ ) ref.
6. Lead dia.  $0.017$  ( $0.43$ ) nom.



## Данный компонент на территории Российской Федерации

### Вы можете приобрести в компании MosChip.

Для оперативного оформления запроса Вам необходимо перейти по данной ссылке:

<http://moschip.ru/get-element>

Вы можете разместить у нас заказ для любого Вашего проекта, будь то серийное производство или разработка единичного прибора.

В нашем ассортименте представлены ведущие мировые производители активных и пассивных электронных компонентов.

Нашей специализацией является поставка электронной компонентной базы двойного назначения, продукции таких производителей как XILINX, Intel (ex.ALTERA), Vicor, Microchip, Texas Instruments, Analog Devices, Mini-Circuits, Amphenol, Glenair.

Сотрудничество с глобальными дистрибьюторами электронных компонентов, предоставляет возможность заказывать и получать с международных складов практически любой перечень компонентов в оптимальные для Вас сроки.

На всех этапах разработки и производства наши партнеры могут получить квалифицированную поддержку опытных инженеров.

Система менеджмента качества компании отвечает требованиям в соответствии с ГОСТ Р ИСО 9001, ГОСТ РВ 0015-002 и ЭС РД 009

### Офис по работе с юридическими лицами:

105318, г.Москва, ул.Щербаковская д.3, офис 1107, 1118, ДЦ «Щербаковский»

Телефон: +7 495 668-12-70 (многоканальный)

Факс: +7 495 668-12-70 (доб.304)

E-mail: [info@moschip.ru](mailto:info@moschip.ru)

Skype отдела продаж:

moschip.ru

moschip.ru\_4

moschip.ru\_6

moschip.ru\_9