



### Main

Range of product	Harmony XAC
Product or component type	Pendant control station
Device short name	XACB

### Complementary

Control station type	Double insulated
Enclosure material	Glass reinforced polyester
Electrical circuit type	Control circuit Power circuit
Enclosure type	Empty enclosure
Number of cut-out	2 cut-outs
Control station colour	Yellow
Cable entry	Rubber sleeve with stepped entry 10...22 mm
Guard rail	Without
Vertical operator cut-out centre	1.57 in (40 mm)
Standards	EN/IEC 60947-5-1 CSA C22.2 No 14
Product certifications	CSA type 4
Protective treatment	TH
Ambient air temperature for operation	-13...158 °F (-25...70 °C)
Ambient air temperature for storage	-40...158 °F (-40...70 °C)
Vibration resistance	15 gn 10...500 Hz IEC 60068-2-6
Shock resistance	100 gn IEC 60068-2-27
Overvoltage category	Class II IEC 61140
IP degree of protection	IP65 IEC 60529
IK degree of protection	IK08 EN 50102
Mechanical durability	1000000 cycles
Product weight	1.68 lb(US) (0.76 kg)

### Environment

#### Offer Sustainability

WARNING: This product can expose you to chemicals including:	WARNING: This product can expose you to chemicals including:
Nickel compounds, which is known to the State of California to cause cancer, and	Nickel compounds, which is known to the State of California to cause cancer, and
Di-isodecyl phthalate (DIDP), which is known to the State of California to cause birth defects or other reproductive harm.	Di-isodecyl phthalate (DIDP), which is known to the State of California to cause birth defects or other reproductive harm.
For more information go to <a href="http://www.p65warnings.ca.gov">www.p65warnings.ca.gov</a>	For more information go to <a href="http://www.p65warnings.ca.gov">www.p65warnings.ca.gov</a>

#### Contractual warranty

Warranty period	18 months
-----------------	-----------

## Dimensions

Below drawing shows a product with 6 cut-outs. Select the number of cut-outs according to the product characteristics in order to get b, b1 and c dimensions.

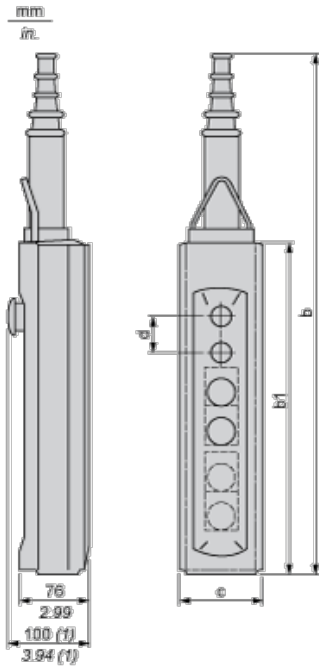

(1) With mushroom head operator

Dimensions in mm

Number of cut-outs	2	4	6	8	12
b	409	499	589	679	679
b1	220	310	400	490	490
c	98	98	98	98	98
d	40	40	40	40	30

Dimensions in in.

Number of cut-outs	2	4	6	8	12
b	16.10	19.64	23.19	26.73	26.73
b1	8.66	12.20	15.75	19.29	19.29
c	3.86	3.86	3.86	3.86	3.86
d	1.57	1.57	1.57	1.57	1.18

Protective cable sleeves

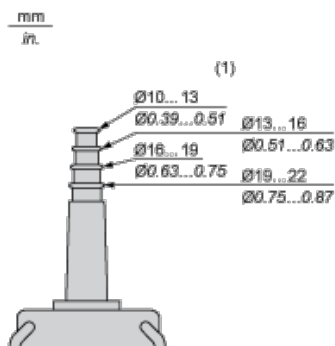

(1) Internal ø

## Control of Single-Speed Reversing Motor

With XESD1181 contact block, to be ordered separately



## Control of 2-Speed Reversing Motor

With XESD1281 contact block, to be ordered separately

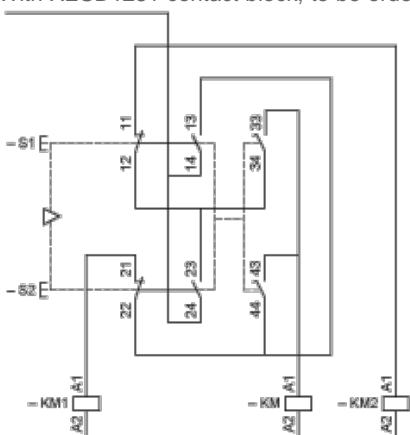

KM High speed contactor

## Control of Single-Speed Reversing Motor 2-Phase Switching

With XESD1191 contact block, to be ordered separately

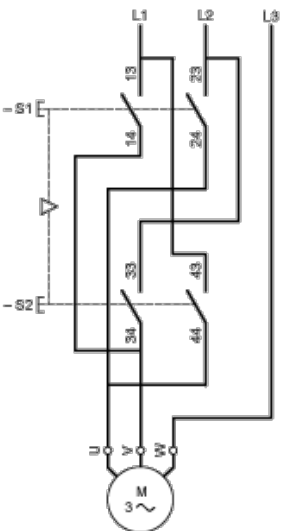

Combined with 3-pole isolating block XACS399 or XACS3991, shown in the unoperated position (pendant station "supplied"), fitted with key release trigger action latching Emergency stop operator.



### Control of 2-Speed Reversing Motor 2-Phase Switching

With XESD1291 contact block, to be ordered separately

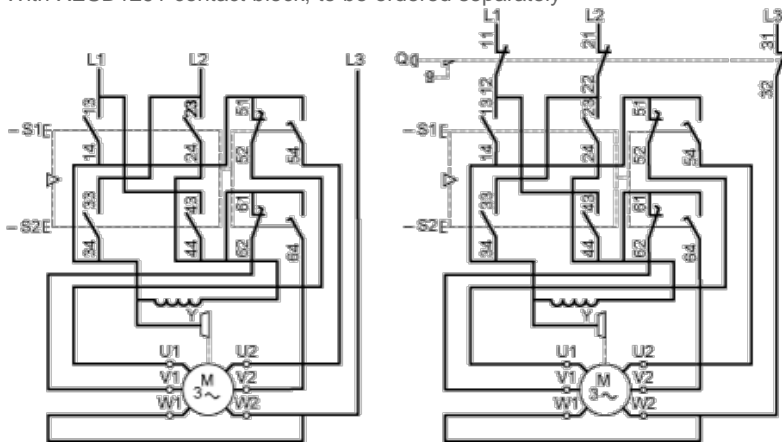

### Control of Single-Speed Reversing Motor 3-Phase switching, Reversing by 2-Phase Inversion

With XESD2201 contact block, to be ordered separately

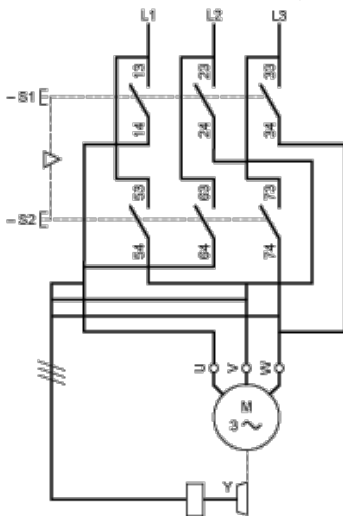

### Control of Single-Speed Reversing Motor 3-Phase switching, Reversing by 2-Phase Inversion

With XESD2241 contact block, to be ordered separately



## Данный компонент на территории Российской Федерации

### Вы можете приобрести в компании MosChip.

Для оперативного оформления запроса Вам необходимо перейти по данной ссылке:

<http://moschip.ru/get-element>

Вы можете разместить у нас заказ для любого Вашего проекта, будь то серийное производство или разработка единичного прибора.

В нашем ассортименте представлены ведущие мировые производители активных и пассивных электронных компонентов.

Нашей специализацией является поставка электронной компонентной базы двойного назначения, продукции таких производителей как XILINX, Intel (ex.ALTERA), Vicor, Microchip, Texas Instruments, Analog Devices, Mini-Circuits, Amphenol, Glenair.

Сотрудничество с глобальными дистрибьюторами электронных компонентов, предоставляет возможность заказывать и получать с международных складов практически любой перечень компонентов в оптимальные для Вас сроки.

На всех этапах разработки и производства наши партнеры могут получить квалифицированную поддержку опытных инженеров.

Система менеджмента качества компании отвечает требованиям в соответствии с ГОСТ Р ИСО 9001, ГОСТ РВ 0015-002 и ЭС РД 009

### Офис по работе с юридическими лицами:

105318, г.Москва, ул.Щербаковская д.3, офис 1107, 1118, ДЦ «Щербаковский»

Телефон: +7 495 668-12-70 (многоканальный)

Факс: +7 495 668-12-70 (доб.304)

E-mail: [info@moschip.ru](mailto:info@moschip.ru)

Skype отдела продаж:

moschip.ru

moschip.ru\_4

moschip.ru\_6

moschip.ru\_9