

Ultra low drop BiCMOS voltage regulator

Datasheet - production data

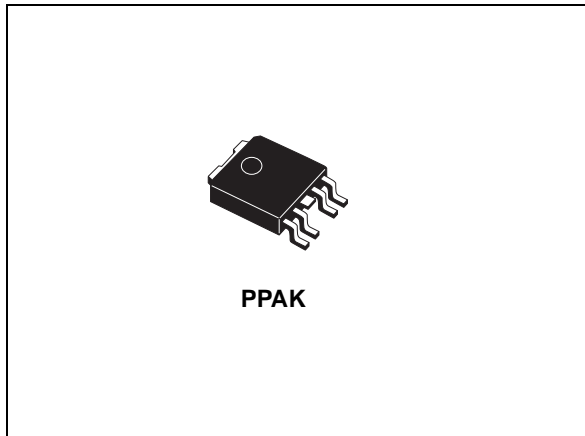

Features

- 0.8 A guaranteed output current
- Ultra low-dropout voltage (150 mV typ. @ 0.8 A load, 20 mV typ. @ 150 mA load)
- Very low quiescent current (1 mA typ. @ 0.8 A load, 1 μ A max. @ 25 °C in off mode)
- Logic-controlled electronic shutdown
- Current and thermal internal limit
- $\pm 1.5\%$ output voltage tolerance @ 25 °C
- ADJ output voltage: 1.22 V to 5.0 V
- Temperature range: - 40 to 125 °C
- Fast dynamic response to line and load changes
- Stable with ceramic capacitor
- Available in PPAK

Applications

- Microprocessor power supply
- DSP power supply
- Post regulators for switching suppliers
- High efficiency linear regulator

Description

The LD39080 is a fast, ultra low drop linear regulator which operates from 2.5 V to 6 V input supply.

A wide range of output options is available. The low drop voltage, low noise, and ultra low quiescent current make it suitable for low voltage microprocessors and memory applications. The device is developed on the BiCMOS process which allows the low quiescent current operation regardless of the output load current.

Table 1. Device summary

PPAK (tape and reel)	Output voltage
LD39080PT-R	ADJ from 1.22 to 5.0 V

Contents

1	Diagram	3
2	Pin configuration	4
3	Typical application circuits	5
4	Maximum ratings	6
5	Electrical characteristics	7
6	Typical performance characteristics	9
7	Application notes	12
	7.1 External capacitor	12
	7.2 Input capacitor	12
	7.3 Output capacitor	12
	7.4 Thermal note	12
	7.5 Inhibit input operation	12
8	Package mechanical data	13
9	Packaging mechanical data	15
10	Revision history	17

1 Diagram

Figure 1. Block diagram

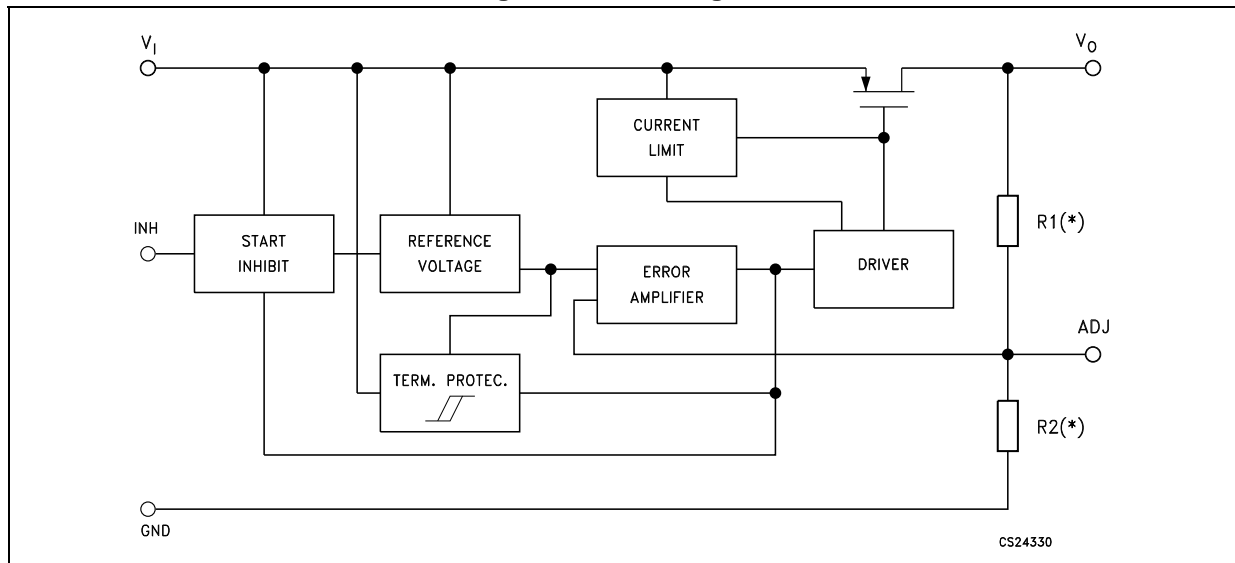

(*) Not present on ADJ version.

2 Pin configuration

Figure 2. Pin connections (top view)

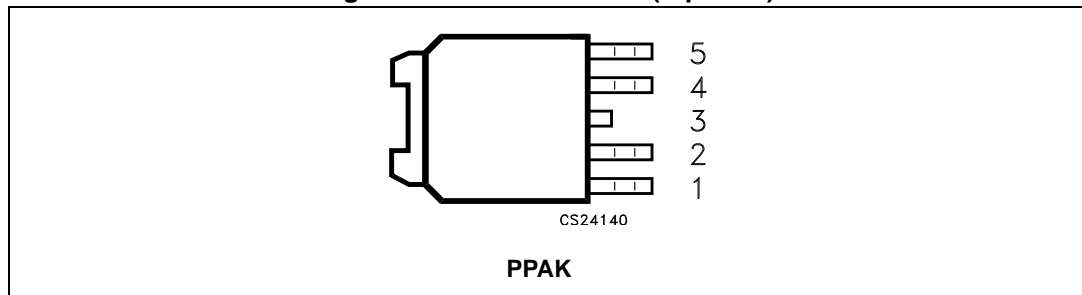

Table 2. Pin description

Pin	Symbol	Note
5	ADJ	Error amplifier input pin for V_O from 1.22 to 5.0 V
2	V_I	LDO input voltage: V_I from 2.5 V to 6 V, $C_I=1 \mu\text{F}$ not farther than 1 cm from input pin
4	V_O	LDO output voltage pins, with minimum $C_O = 2.2 \mu\text{F}$ needed for stability (refer to C_O vs ESR stability chart)
1	V_{INH}	Inhibit input voltage: on mode when $V_{INH} \geq 2 \text{ V}$, off mode when $V_{INH} \leq 0.3 \text{ V}$ (do not leave it floating, not internally pulled down/up)
3	GND	Common ground

3 Typical application circuits

(C_I and C_O capacitors have to be placed as closer as possible to the IC pin).

Figure 3. LD39080 adjustable version

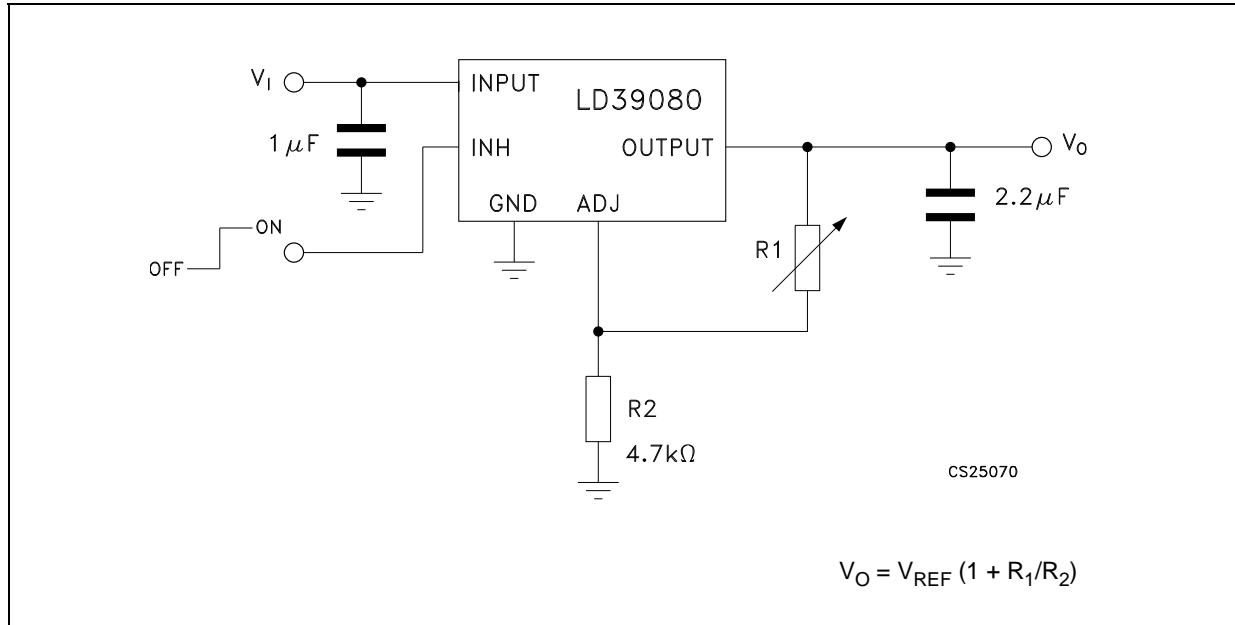

Note: Set R₂ as closer as possible to 4.7 KΩ.

Figure 4. Timing diagram

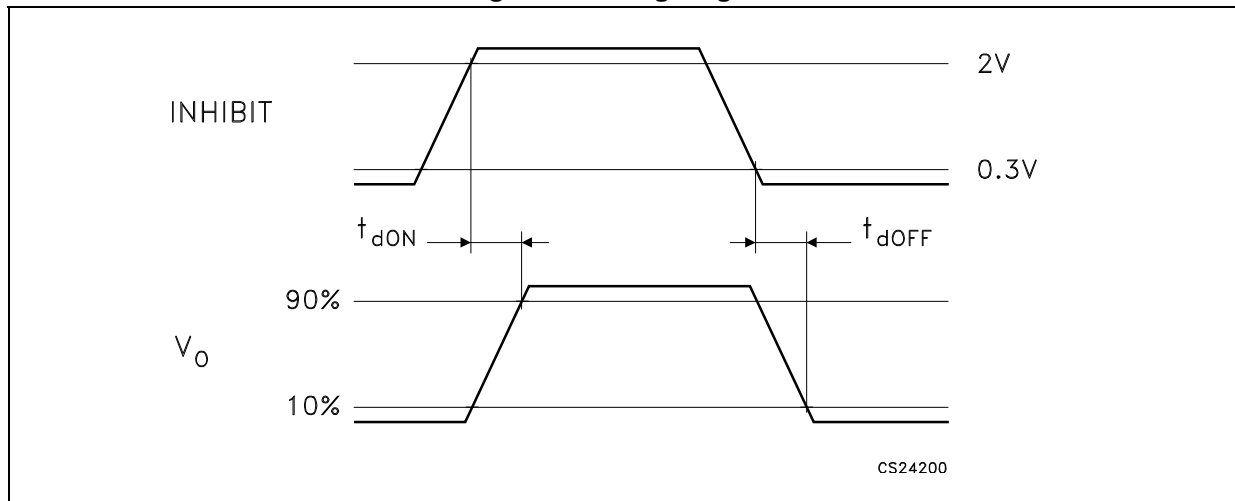

4 Maximum ratings

Table 3. Absolute maximum ratings

Symbol	Parameter	Value	Unit
V_I	DC input voltage	-0.3 to 6.5	V
V_{INH}	Inhibit input voltage	-0.3 to $V_I + 0.3$ (6.5 V max.)	V
V_O	DC output voltage	-0.3 to $V_I + 0.3$ (6.5 V max.)	V
V_{ADJ}	ADJ pin voltage	-0.3 to $V_I + 0.3$ (6.5 V max.)	V
I_O	Output current	Internally limited	mA
P_D	Power dissipation	Internally limited	mW
T_{STG}	Storage temperature range	-50 to 150	°C
T_{OP}	Operating junction temperature range	-40 to 125	°C

Note: Absolute maximum ratings are those values beyond which damage to the device may occur. Functional operation under these conditions is not implied. All values are referred to GND.

Table 4. Thermal data

Symbol	Parameter	Value	Unit
R_{thJA}	Thermal resistance junction-ambient	100	°C/W
R_{thJC}	Thermal resistance junction-case	8	°C/W

5 Electrical characteristics

$T_J = 25\text{ °C}$, $V_I = V_O + 1\text{ V}$, $C_I = 1\text{ }\mu\text{F}$, $C_O = 2.2\text{ }\mu\text{F}$, $I_{LOAD} = 10\text{ mA}$, $V_{INH} = 2\text{ V}$, unless otherwise specified.

Table 5. Electrical characteristics

Symbol	Parameter	Conditions	Min.	Typ.	Max.	Unit
V_I	Operating input voltage		2.5		6	V
V_O	Output voltage tolerance	$V_I = V_O + 1\text{ V}$, $I_{LOAD} = 10\text{ mA to }0.8\text{ A}$	-1.5		1.5	% of $V_{O(NOM)}$
		$V_I = V_O + 1\text{ V to }6\text{ V}$, $I_{LOAD} = 10\text{ mA to }0.8\text{ A}$ $T_J = -40\text{ to }125\text{ °C}$	-3		3	
V_{REF}	Reference voltage			1.22		V
ΔV_O	Output voltage line regulation	$V_I = V_O + 1\text{ V to }6\text{ V}$		0.04		%
		$V_I = V_O + 1\text{ V to }6\text{ V}$, $T_J = -40\text{ to }125\text{ °C}$		0.1	0.2	%
$\Delta V_O / \Delta I_{LOAD}$	Output voltage load regulation	$I_{LOAD} = 10\text{ mA to }0.8\text{ A}$		0.06		% / A
		$I_{LOAD} = 10\text{ mA to }0.8\text{ A}$, $T_J = -40\text{ to }125\text{ °C}$		0.2	0.4	
V_{DROP}	Dropout voltage ($V_I - V_O$)	$I_{LOAD} = 150\text{ mA}$, $T_J = -40\text{ to }125\text{ °C}$		20	40	mV
		$I_{LOAD} = 0.8\text{ A}$, $T_J = -40\text{ to }125\text{ °C}$		150	300	
I_Q	Quiescent current: on mode	$I_{LOAD} = 10\text{ mA to }0.8\text{ A}$, $V_{INH} = 2\text{ V}$ $T_J = -40\text{ to }125\text{ °C}$		1	2.5	mA
	Quiescent current: off mode	$V_{INH} = 0.3\text{ V}$			1	μA
		$V_{INH} = 0.3\text{ V}$, $T_J = -40\text{ to }125\text{ °C}$			5	
Short-circuit protection						
I_{SC}	Short-circuit protection	$R_L = 0$		1.6		A
Inhibit Input						
V_{INH}	Inhibit threshold low	$V_I = 2.5\text{ to }6\text{ V off}$ $T_J = -40\text{ to }125\text{ °C}$			0.3	V
	Inhibit threshold high		2			
T_{D-OFF}	Current limit	$I_{LOAD} = 0.8\text{ A}$, $V_O = 3.3\text{ V}$		15		μs
T_{D-ON}	Current limit	$I_{LOAD} = 0.8\text{ A}$, $V_O = 3.3\text{ V}$		15		
I_{INH}	Inhibit input current ⁽¹⁾	$V_I = 6\text{ V}$, $V_{INH} = 0\text{ to }6\text{ V}$		± 0.1	± 1	μA
AC parameters						
SVR	Supply voltage rejection	$V_I = 4.5 \pm 1\text{ V}$, $V_O = 3.3\text{ V}$, $I_{LOAD} = 10\text{ mA}$,	$f = 120\text{ Hz}$		65	dB
			$f = 1\text{ kHz}$		55	

Table 5. Electrical characteristics (continued)

Symbol	Parameter	Conditions	Min.	Typ.	Max.	Unit
e_N	Output noise voltage	$B_W = 10 \text{ Hz to } 100 \text{ kHz}$, $C_O = 2.2 \text{ } \mu\text{F}$, $V_O = 2.5 \text{ V}$		100		μV_{RMS}
T_{SHDN}	Thermal shutdown off			170		$^{\circ}\text{C}$
	Hysteresis			10		

1. Guaranteed by design.

6 Typical performance characteristics

$T_J = 25\text{ }^\circ\text{C}$, $V_I = V_O + 1\text{ V}$, $C_I = 1\text{ }\mu\text{F}$, $C_O = 2.2\text{ }\mu\text{F}$, $I_{LOAD} = 10\text{ mA}$, $V_{INH} = V_I$, unless otherwise specified.

Figure 5. Output voltage vs temperature

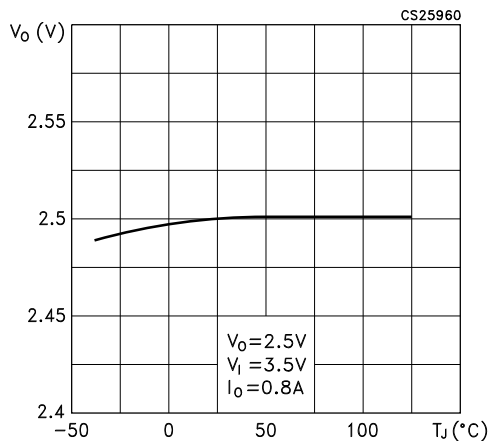

Figure 6. Dropout voltage vs temperature

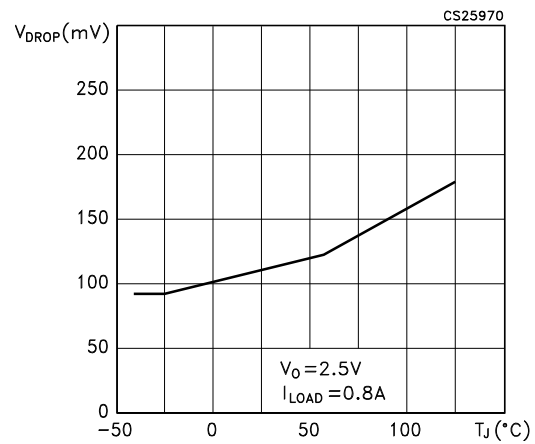

Figure 7. Dropout voltage vs output current

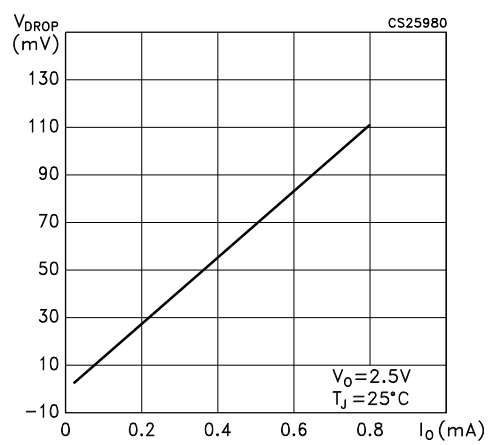
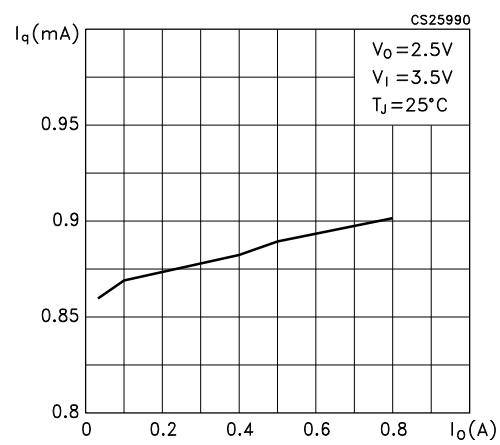

Figure 8. Quiescent current vs output current



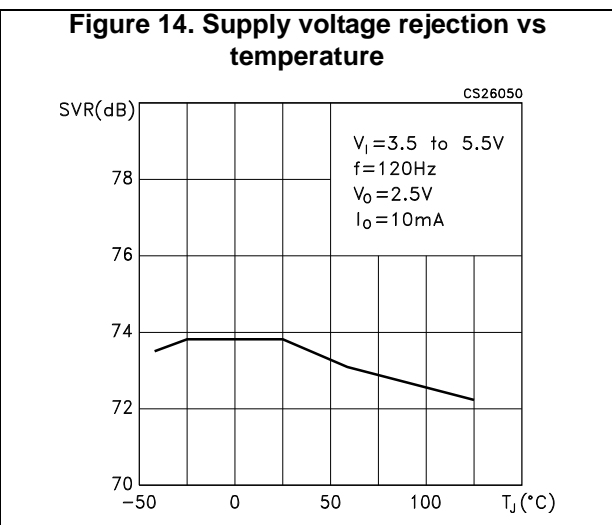
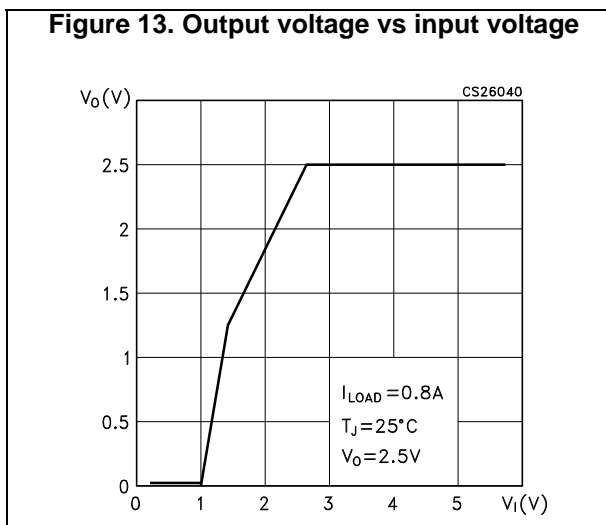
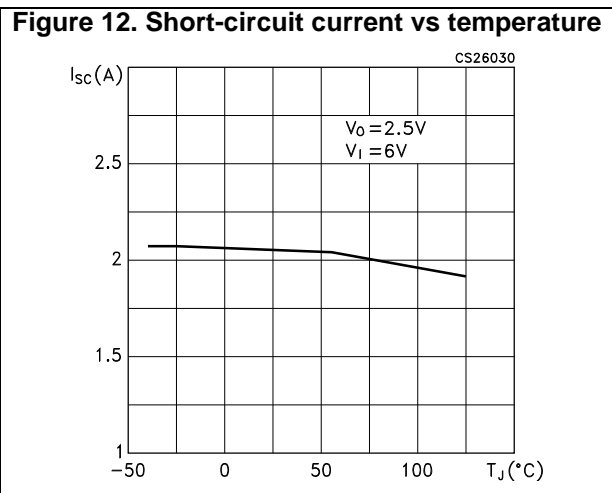
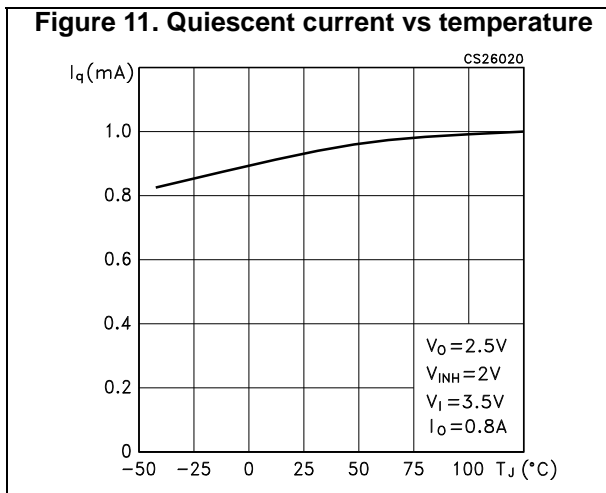
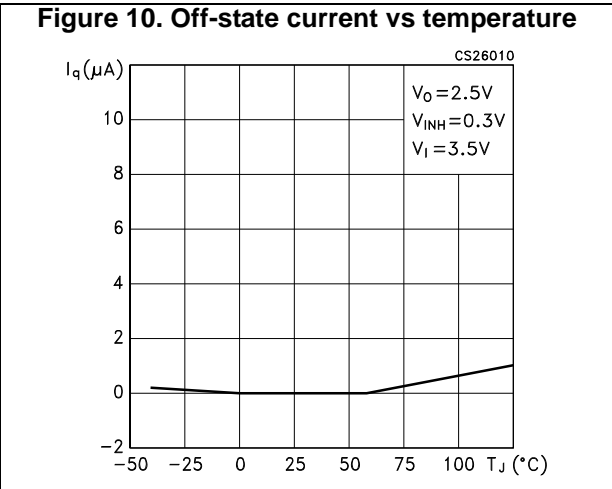
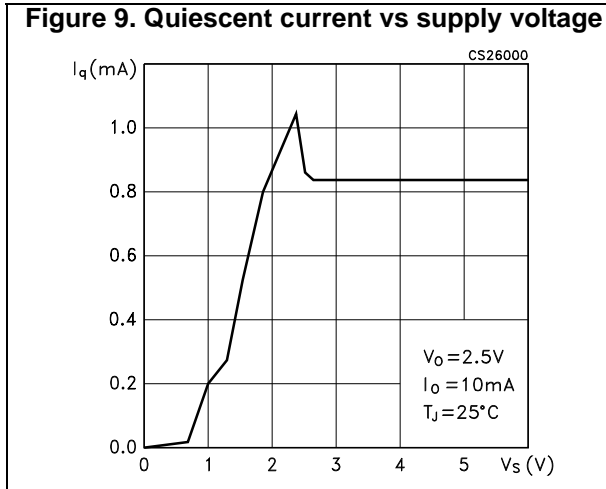

Figure 15. Stability region vs Co and ESR (at 100 kHz)

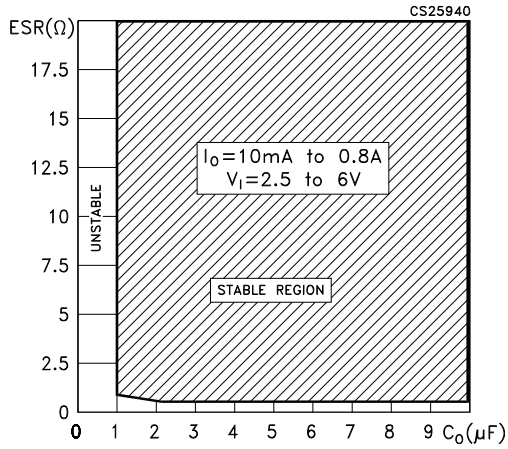

Figure 16. Stability region vs Co and low ESR (at 100 kHz)

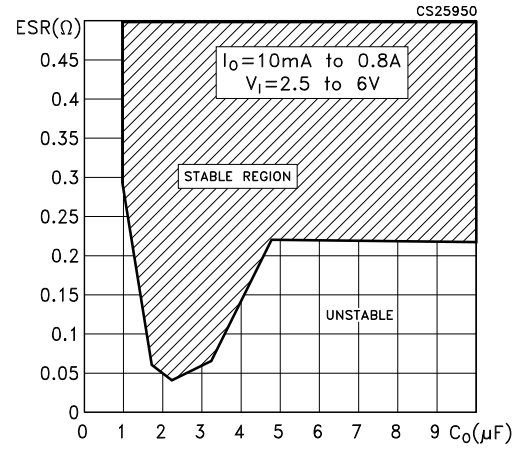

Figure 17. Load transient

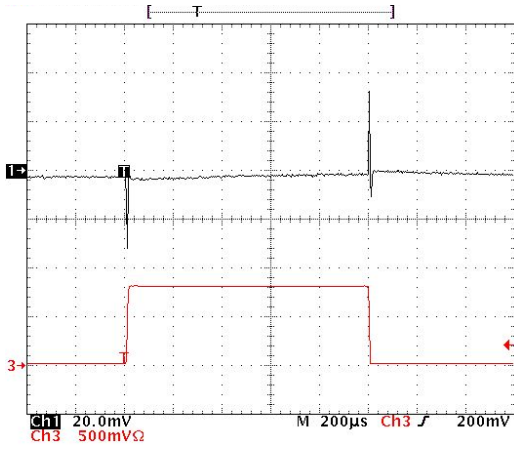
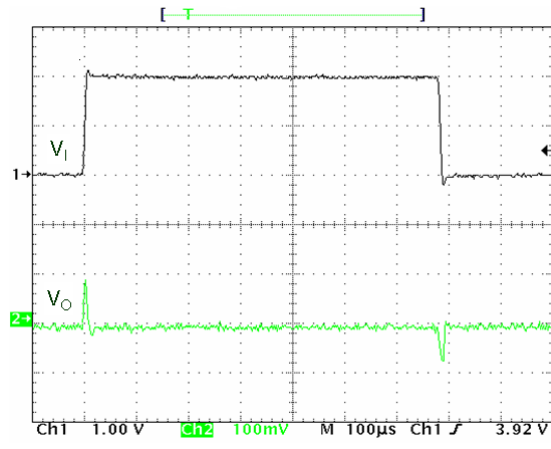

Figure 18. Line transient



7 Application notes

7.1 External capacitor

The LD39080 requires external capacitors to assure the stability. These capacitors have to meet the requirements of minimum capacitance and equivalent series resistance (see [Figure 16 Figure 17](#)). The input/output capacitors cannot be farther than 1 cm from the relative pins and have to be connected directly to the input/output ground pins using traces without any current flowing through them. Ceramic or electrolytic capacitors can be used.

7.2 Input capacitor

An input capacitor, whose minimum value is 1 μF , is required (the amount of capacitance can be increased without any limit). This capacitor cannot be farther than 1 cm from the input pin of the device and has to return to clean analog ground. Ceramic, tantalum or film capacitors can be used.

7.3 Output capacitor

Ceramic or tantalum capacitors can be used but the output capacitor has to meet the requirements of minimum capacitance and ESR (equivalent series resistance) value. A minimum capacitance of 2.2 μF is a good choice to guarantee the stability of the regulator. Anyway, other C_O values can be used as per [Figure 16 Figure 17](#), where the allowable ESR range is seen as a function of the output capacitance. The curve represents the stability region over the full temperature and I_O range.

7.4 Thermal note

The output capacitor has to maintain its ESR in the stable region over the operating temperature range to assure the stability. Besides, capacitor tolerance and temperature variation have to be taken into account to assure the minimum amount of capacitance all time.

7.5 Inhibit input operation

The inhibit pin can be used to turn off the regulator when pulled down, therefore by reducing the current consumption below 1 μA . When the inhibit feature is not used, this pin has to be tied to V_I to turn on the regulator output all the time. To assure the right operation, the signal source, used to drive the inhibit pin, has to swing above and below the specified thresholds listed in [Section 5: Electrical characteristics](#) (V_{IH} V_{IL}). The inhibit pin must not be left floating because it is not internally pulled down/up.

8 Package mechanical data

Figure 19. PPAK drawings

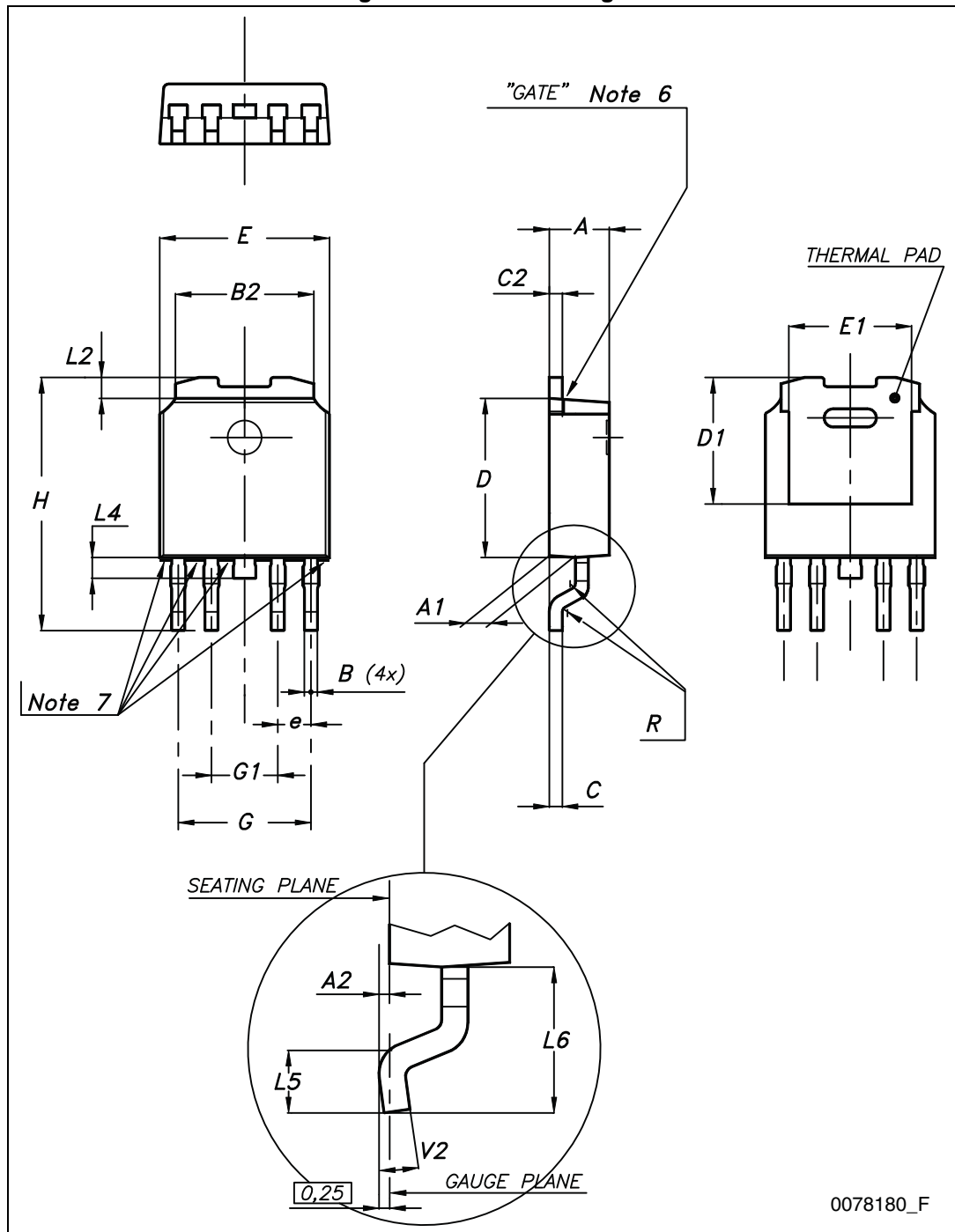

Table 6. PPAK mechanical data

Dim.	mm		
	Min.	Typ.	Max.
A	2.2		2.4
A1	0.9		1.1
A2	0.03		0.23
B	0.4		0.6
B2	5.2		5.4
C	0.45		0.6
C2	0.48		0.6
D	6		6.2
D1		5.1	
E	6.4		6.6
E1		4.7	
e		1.27	
G	4.9		5.25
G1	2.38		2.7
H	9.35		10.1
L2		0.8	1
L4	0.6		1
L5	1		
L6		2.8	
R		0.20	
V2	0°		8°

9 Packaging mechanical data

Figure 20. PPAK tape

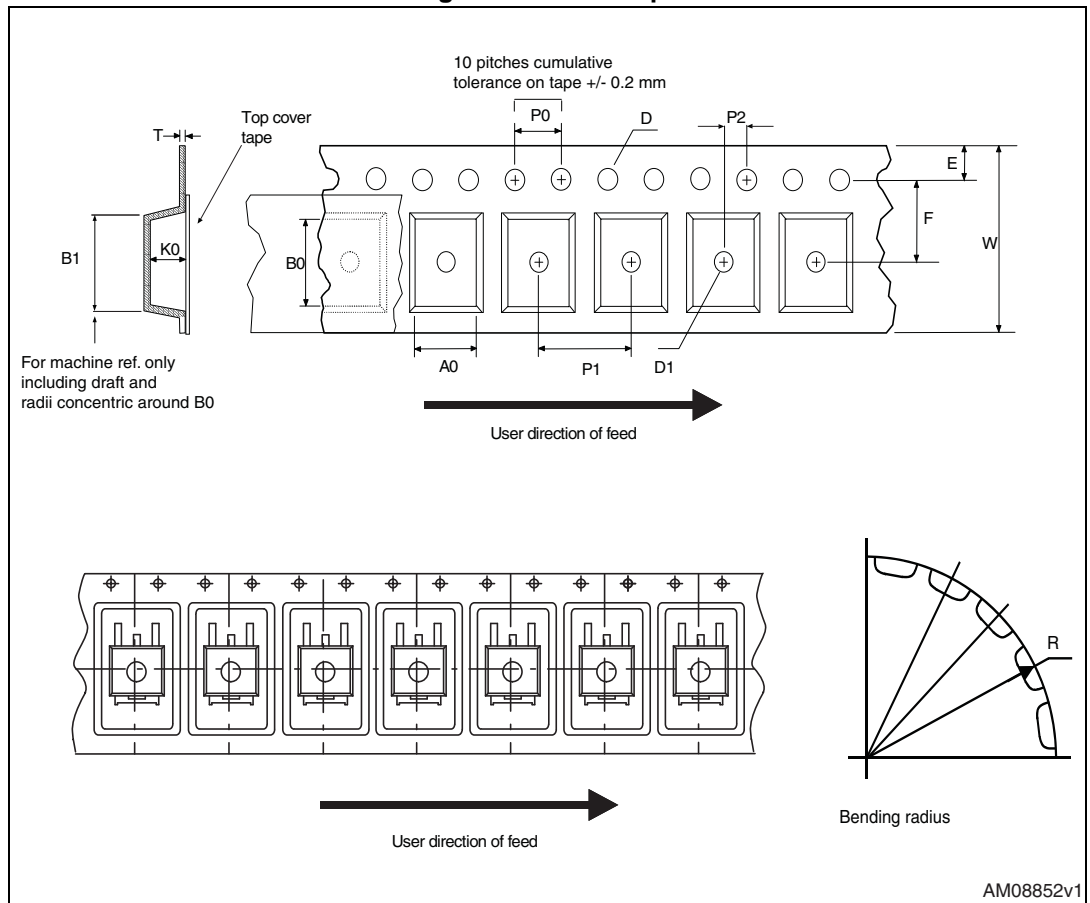

Figure 21. PPAK reel

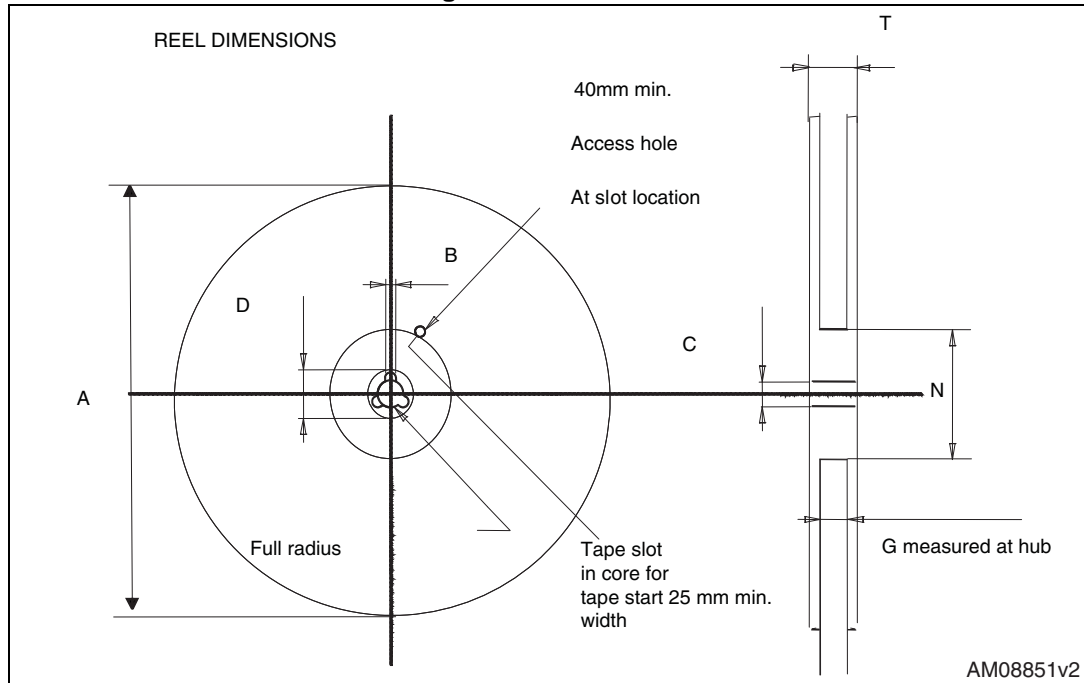

Table 7. PPAK tape and reel mechanical data

Tape			Reel		
Dim.	mm		Dim.	mm	
	Min.	Max.		Min.	Max.
A0	6.8	7	A		330
B0	10.4	10.6	B	1.5	
B1		12.1	C	12.8	13.2
D	1.5	1.6	D	20.2	
D1	1.5		G	16.4	18.4
E	1.65	1.85	N	50	
F	7.4	7.6	T		22.4
K0	2.55	2.75			
P0	3.9	4.1		Base qty.	2500
P1	7.9	8.1		Bulk qty.	2500
P2	1.9	2.1			
R	40				
T	0.25	0.35			
W	15.7	16.3			

10 Revision history

Table 8. Document revision history

Date	Revision	Changes
26-Jan-2007	1	Initial release.
25-Mar-2014	2	Updated features in cover page, <i>Section 5: Electrical characteristics</i> , <i>Section 6: Typical performance characteristics</i> , <i>Section 7: Application notes</i> , <i>Section 8: Package mechanical data</i> . Added <i>Section 9: Packaging mechanical data</i> . Minor text changes.
01-Aug-2017	3	Updated Table 1: Device summary on the cover page.

IMPORTANT NOTICE – PLEASE READ CAREFULLY

STMicroelectronics NV and its subsidiaries ("ST") reserve the right to make changes, corrections, enhancements, modifications, and improvements to ST products and/or to this document at any time without notice. Purchasers should obtain the latest relevant information on ST products before placing orders. ST products are sold pursuant to ST's terms and conditions of sale in place at the time of order acknowledgement.

Purchasers are solely responsible for the choice, selection, and use of ST products and ST assumes no liability for application assistance or the design of Purchasers' products.

No license, express or implied, to any intellectual property right is granted by ST herein.

Resale of ST products with provisions different from the information set forth herein shall void any warranty granted by ST for such product.

ST and the ST logo are trademarks of ST. All other product or service names are the property of their respective owners.

Information in this document supersedes and replaces information previously supplied in any prior versions of this document.

© 2017 STMicroelectronics – All rights reserved

Данный компонент на территории Российской Федерации

Вы можете приобрести в компании MosChip.

Для оперативного оформления запроса Вам необходимо перейти по данной ссылке:

<http://moschip.ru/get-element>

Вы можете разместить у нас заказ для любого Вашего проекта, будь то серийное производство или разработка единичного прибора.

В нашем ассортименте представлены ведущие мировые производители активных и пассивных электронных компонентов.

Нашей специализацией является поставка электронной компонентной базы двойного назначения, продукции таких производителей как XILINX, Intel (ex.ALTERA), Vicor, Microchip, Texas Instruments, Analog Devices, Mini-Circuits, Amphenol, Glenair.

Сотрудничество с глобальными дистрибьюторами электронных компонентов, предоставляет возможность заказывать и получать с международных складов практически любой перечень компонентов в оптимальные для Вас сроки.

На всех этапах разработки и производства наши партнеры могут получить квалифицированную поддержку опытных инженеров.

Система менеджмента качества компании отвечает требованиям в соответствии с ГОСТ Р ИСО 9001, ГОСТ РВ 0015-002 и ЭС РД 009

Офис по работе с юридическими лицами:

105318, г.Москва, ул.Щербаковская д.3, офис 1107, 1118, ДЦ «Щербаковский»

Телефон: +7 495 668-12-70 (многоканальный)

Факс: +7 495 668-12-70 (доб.304)

E-mail: info@moschip.ru

Skype отдела продаж:

moschip.ru

moschip.ru_4

moschip.ru_6

moschip.ru_9