



## **Power line chokes**

Current-compensated D core double chokes  
250 V AC, 0.35 ... 1.8 A, 3.3 ... 100 mH

**Series/Type:** B82731M/H

**Date:** March 2008

**Rated voltage 250 V AC**  
**Rated current 0.35 A to 1.8 A**  
**Rated inductance 3.3 mH to 100 mH**

### Construction

- Current-compensated double choke
- Closed rectangular ferrite core
- Closed polycarbonate coil former (UL 94 V-0)
- Without encapsulation
- 2-section winding
- Clearance and creepage distances > 3 mm

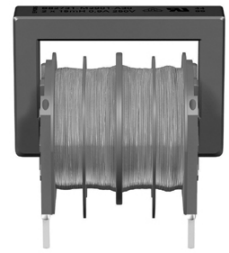
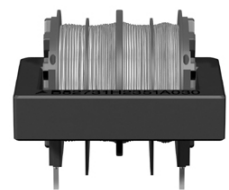
**B82731M**

**B82731H**

### Features

- High resonance frequency due to 2-section winding
- Approx. 1% stray inductance for symmetrical interference suppression
- Low leakage due to closed core shape
- High pulse strength
- Low whirring noise
- Suitable for wave soldering
- Design complies with EN 60938-2 (VDE 0565-2)
- UL and VDE approvals 
- Recyclable owing to omission of encapsulation and glue
- RoHS-compatible

### Applications

- Suppression of common-mode interferences
- Compact switch-mode power applications
- Electronic ballasts in lamps

### Terminals

- Base material CuNi18Zn20
- Layer composition Ni, Sn
- Hot-dipped
- Pins 0.6 × 0.6 (mm)
- Lead spacing 10 × 12.5 (mm)

### Marking

- B82731M: Manufacturer, rated inductance, rated current, ordering code, approval symbols, date of manufacture (WWYY)
- B82731H: Manufacturer, ordering code

### Delivery mode

Blister tray in cardboard box

**Dimensional drawings and pin configurations (dimensions in mm)**

Vertical version (B82731M)

Horizontal version (B82731H)

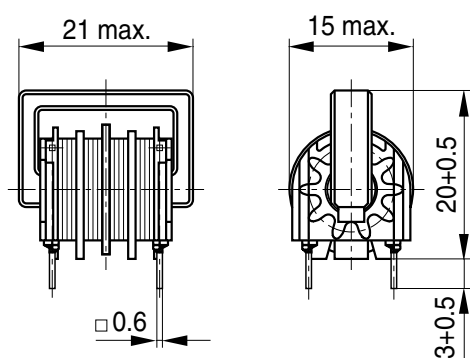
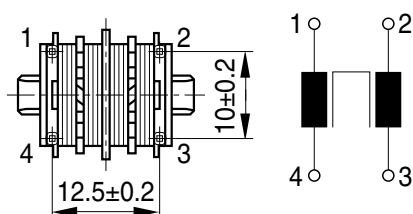

IND0284-2

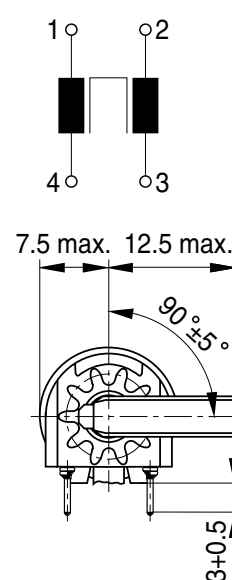
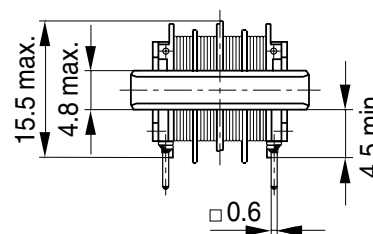
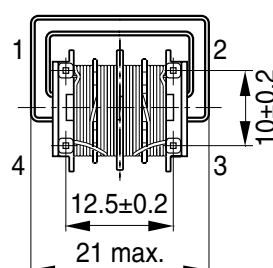



IND0285-5

Dimensions in mm

**Technical data and measuring conditions**

Rated voltage $V_R$	250 V AC (50/60 Hz)
Test voltage $V_{test}$	1500 V AC, 2 s (line/line)
Rated temperature $T_R$	40 °C
Rated current $I_R$	Referred to 50 Hz and rated temperature
Rated inductance $L_R$	Measured with Agilent 4284A at 10 kHz, 0.1 mA, 20 °C. Inductance is specified per winding.
Inductance tolerance	-30/+50% at 20 °C
Inductance decrease $\Delta L/L_0$	< 10% at DC magnetic bias with $I_R$ , 20 °C
Stray inductance $L_{stray,typ}$	Measured with Agilent 4284A at 10 kHz, 5 mA, 20 °C, typ. values
DC resistance $R_{typ}$	Measured at 20 °C, typical values, specified per winding
Solderability (lead-free)	Sn96.5Ag3.0Cu0.5: (245 ±5) °C, (3 ±0.3) s Wetting of soldering area ≥ 95% (to IEC 60068-2-20, test Ta)
Resistance to soldering heat (wave soldering)	(260 ±5) °C, (10 ±1) s (to IEC 60068-2-20, test Tb)
Climatic category	40/125/56 (to IEC 60068-1)
Storage conditions (packaged)	-25 °C ... +40 °C, ≤ 75% RH
Weight	Approx. 8 g
Approvals	EN 60938-2, UL 1283

Characteristics and ordering codes

$I_R$ A	$L_R$ mH	$L_{stray,typ}$ $\mu$ H	$R_{typ}$ m $\Omega$	Ordering code		Approvals	
				Vertical version	Horizontal version		
0.35	100	1000	4500	B82731M2351A030	B82731H2351A030	×	×
0.4	68	700	3000	B82731M2401A033	B82731H2401A033	×	×
0.5	47	470	2000	B82731M2501A030	B82731H2501A030	×	×
0.6	39	390	1500	B82731M2601A030	B82731H2601A030	×	×
0.7	27	270	1000	B82731M2701A030	B82731H2701A030	×	×
0.8	22	220	800	B82731M2801A030	B82731H2801A030	—	—
0.9	15	150	600	B82731M2901A030	B82731H2901A030	×	×
1.1	10	100	400	B82731M2112A030	B82731H2112A030	×	×
1.3	6.8	70	280	B82731M2132A030	B82731H2132A030	×	×
1.8	3.3	35	140	B82731M2182A030	B82731H2182A030	×	×

× = approval granted

Sample kit available. Ordering code: B82731X001.

For more information refer to chapter "Sample kits".

**Impedance  $|Z|$  versus frequency  $f$**   
measured with windings in parallel at 20 °C,  
typical values

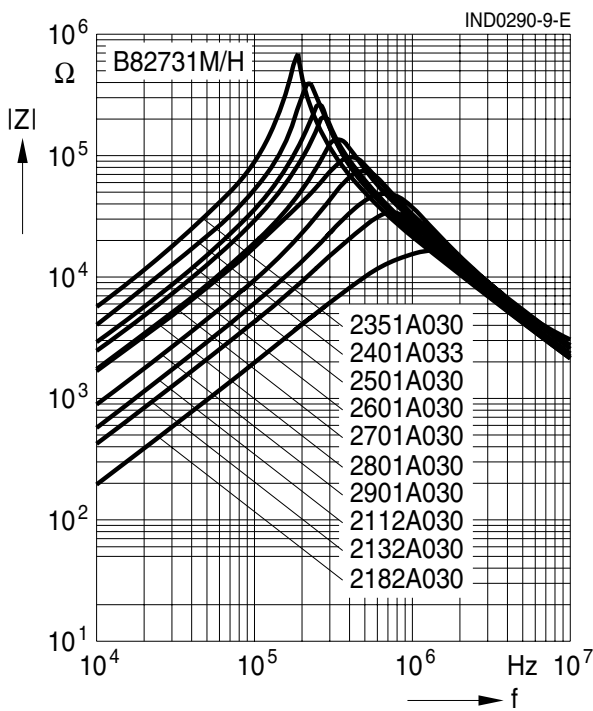

**Current derating  $I_{op}/I_R$**   
**versus ambient temperature  $T_A$**

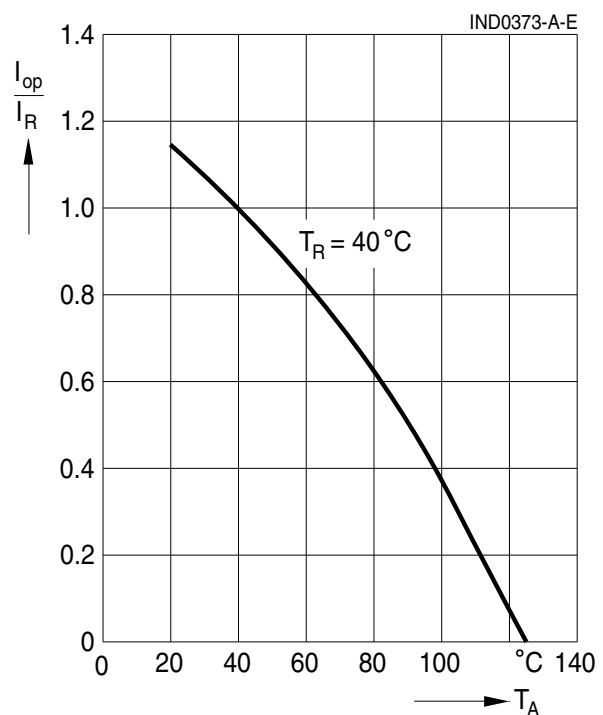

## Cautions and warnings

- Please note the recommendations in our Inductors data book (latest edition) and in the data sheets.
  - Particular attention should be paid to the derating curves given there.
  - The soldering conditions should also be observed. Temperatures quoted in relation to wave soldering refer to the pin, not the housing.
- If the components are to be washed varnished it is necessary to check whether the washing varnish agent that is used has a negative effect on the wire insulation, any plastics that are used, or on glued joints. In particular, it is possible for washing varnish agent residues to have a negative effect in the long-term on wire insulation.
- The following points must be observed if the components are potted in customer applications:
  - Many potting materials shrink as they harden. They therefore exert a pressure on the plastic housing or core. This pressure can have a deleterious effect on electrical properties, and in extreme cases can damage the core or plastic housing mechanically.
  - It is necessary to check whether the potting material used attacks or destroys the wire insulation, plastics or glue.
  - The effect of the potting material can change the high-frequency behaviour of the components.
- Ferrites are sensitive to direct impact. This can cause the core material to flake, or lead to breakage of the core.
- Even for customer-specific products, conclusive validation of the component in the circuit can only be carried out by the customer.

## Important notes

The following applies to all products named in this publication:

1. Some parts of this publication contain **statements about the suitability of our products for certain areas of application**. These statements are based on our knowledge of typical requirements that are often placed on our products in the areas of application concerned. We nevertheless expressly point out **that such statements cannot be regarded as binding statements about the suitability of our products for a particular customer application**.

As a rule, EPCOS is either unfamiliar with individual customer applications or less familiar with them than the customers themselves. For these reasons, it is always ultimately incumbent on the customer to check and decide whether an EPCOS product with the properties described in the product specification is suitable for use in a particular customer application.

2. We also point out that **in individual cases, a malfunction of passive electronic components or failure before the end of their usual service life cannot be completely ruled out in the current state of the art, even if they are operated as specified**. In customer applications requiring a very high level of operational safety and especially in customer applications in which the malfunction or failure of a passive electronic component could endanger human life or health (e.g. in accident prevention or life-saving systems), it must therefore be ensured by means of suitable design of the customer application or other action taken by the customer (e.g. installation of protective circuitry or redundancy) that no injury or damage is sustained by third parties in the event of malfunction or failure of a passive electronic component.
3. **The warnings, cautions and product-specific notes must be observed.**
4. In order to satisfy certain technical requirements, **some of the products described in this publication may contain substances subject to restrictions in certain jurisdictions (e.g. because they are classed as hazardous)**. Useful information on this will be found in our Material Data Sheets on the Internet ([www.epcos.com/material](http://www.epcos.com/material)). Should you have any more detailed questions, please contact our sales offices.
5. We constantly strive to improve our products. Consequently, **the products described in this publication may change from time to time**. The same is true of the corresponding product specifications. Please check therefore to what extent product descriptions and specifications contained in this publication are still applicable before or when you place an order.

We also **reserve the right to discontinue production and delivery of products**. Consequently, we cannot guarantee that all products named in this publication will always be available.

The aforementioned does not apply in the case of individual agreements deviating from the foregoing for customer-specific products.

6. Unless otherwise agreed in individual contracts, **all orders are subject to the current version of the “General Terms of Delivery for Products and Services in the Electrical Industry” published by the German Electrical and Electronics Industry Association (ZVEI)**.
7. The trade names EPCOS, BAOKE, Alu-X, CeraDiode, CSSP, CTVS, DSSP, MiniBlue, MKK, MLSC, MotorCap, PCC, PhaseCap, PhaseMod, SIFERRIT, SIFI, SIKOREL, SilverCap, SIMDAD, SIMID, SineFormer, SIOV, SIP5D, SIP5K, ThermoFuse, WindCap are **trademarks registered or pending** in Europe and in other countries. Further information will be found on the Internet at [www.epcos.com/trademarks](http://www.epcos.com/trademarks).

## Данный компонент на территории Российской Федерации

### Вы можете приобрести в компании MosChip.

Для оперативного оформления запроса Вам необходимо перейти по данной ссылке:

<http://moschip.ru/get-element>

Вы можете разместить у нас заказ для любого Вашего проекта, будь то серийное производство или разработка единичного прибора.

В нашем ассортименте представлены ведущие мировые производители активных и пассивных электронных компонентов.

Нашей специализацией является поставка электронной компонентной базы двойного назначения, продукции таких производителей как XILINX, Intel (ex.ALTERA), Vicor, Microchip, Texas Instruments, Analog Devices, Mini-Circuits, Amphenol, Glenair.

Сотрудничество с глобальными дистрибьюторами электронных компонентов, предоставляет возможность заказывать и получать с международных складов практически любой перечень компонентов в оптимальные для Вас сроки.

На всех этапах разработки и производства наши партнеры могут получить квалифицированную поддержку опытных инженеров.

Система менеджмента качества компании отвечает требованиям в соответствии с ГОСТ Р ИСО 9001, ГОСТ РВ 0015-002 и ЭС РД 009

### Офис по работе с юридическими лицами:

105318, г.Москва, ул.Щербаковская д.3, офис 1107, 1118, ДЦ «Щербаковский»

Телефон: +7 495 668-12-70 (многоканальный)

Факс: +7 495 668-12-70 (доб.304)

E-mail: [info@moschip.ru](mailto:info@moschip.ru)

Skype отдела продаж:

moschip.ru

moschip.ru\_4

moschip.ru\_6

moschip.ru\_9