

B05S-HF Thru. B10S-HF

Reverse Voltage: 50 to 1000 Volts

Forward Current: 0.8 A

RoHS Device

Halogen Free

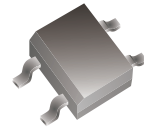

Features

- Rating to 1000V PRV.
- Ideal for printed circuit board.
- Reliable low cost construction utilizing molded plastic technique results in inexpensive product.
- Pb free product.
- UL recognized file # E349301

Mechanical data

- Polarity: Symbol molded on body.
- Weight: 0.125 grams.
- Mounting position: Any.

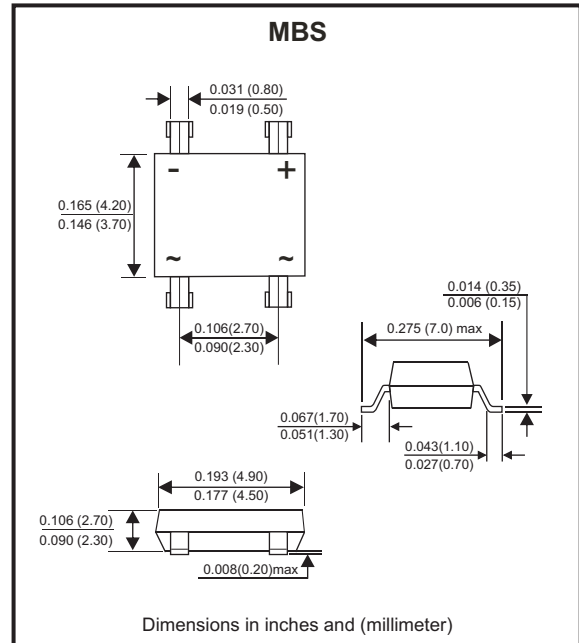

Maximum Rating And Electrical Characteristics

Rating at $T_A=25^{\circ}\text{C}$, unless otherwise noted.
 Single phase, half wave, 60Hz, resistive or inductive load.
 For capacitive load, derate current by 20%.

Parameter	Symbol	B05S-HF	B1S-HF	B2S-HF	B4S-HF	B6S-HF	B8S-HF	B10S-HF	Unit
Maximum Recurrent Peak Reverse Voltage	V_{RRM}	50	100	200	400	600	800	1000	V
Maximum RMS Voltage	V_{RMS}	35	70	140	280	420	560	700	V
Maximum DC Blocking Voltage	V_{DC}	50	100	200	400	600	800	1000	V
Maximum Average Forward Rectified Current (Note 1) @ $T_A=40^{\circ}\text{C}$	$I_{(AV)}$	0.8							A
Peak Forward Surge Current, 8.3ms single half sine-wave, superimposed on rated load (JEDEC Method)	I_{FSM}	30							A
Peak Forward Voltage at 0.8A DC	V_F	1.1							V
Maximum DC Reverse Current at Rated DC Blocking Voltage @ $T_J=25^{\circ}\text{C}$ @ $T_J=125^{\circ}\text{C}$	I_R	5.0 500							μA
Typical Junction Capacitance per element (Note 2)	C_J	15							pF
Typical Thermal Resistance	Junction to ambient	$R_{\theta JA}$							$^{\circ}\text{C/W}$
	Junction to case	$R_{\theta JC}$							
Operating Temperature Range	T_J	-55 to +150							$^{\circ}\text{C}$
Storage Temperature Range	T_{STG}	-55 to +150							$^{\circ}\text{C}$

Notes: 1. Mounted on P.C. Board.
 2. Measured at 1.0MHz and applied reverse voltage of 4V DC.

Company reserves the right to improve product design, functions and reliability without notice.

REV:C

RATING AND CHARACTERISTIC CURVES (B05S-HF thru. B10S-HF)

Fig.1 - Forward Current Derating Curve

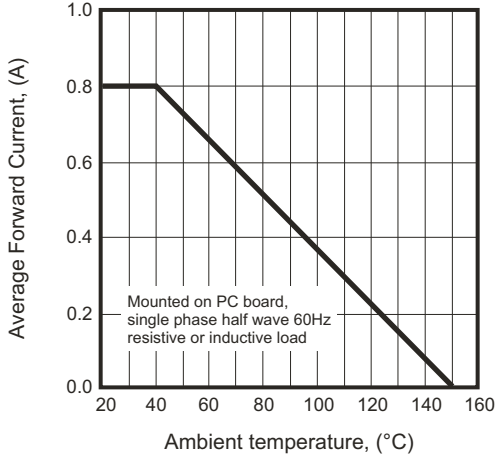

Fig.2 - Maximum Non-Repetitive Surge Current

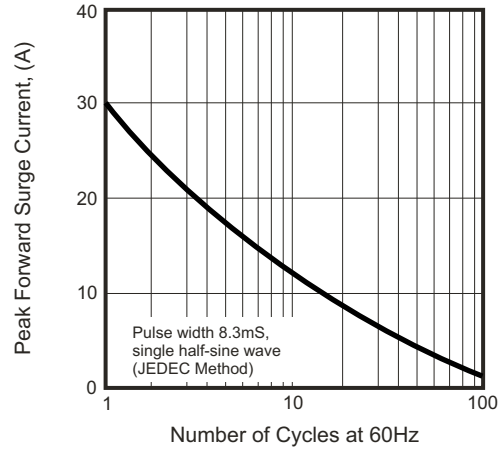

Fig.3 - Typical Reverse Characteristics

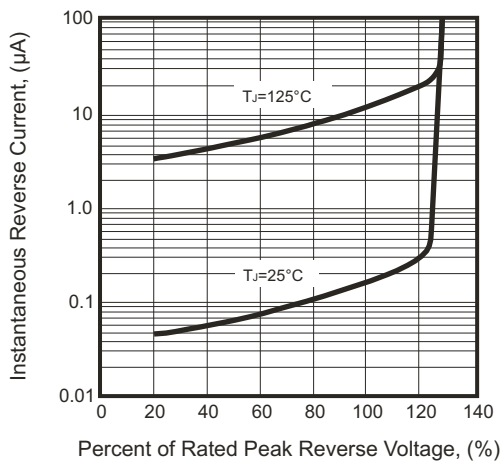

Fig.4 - Typical Forward Characteristics

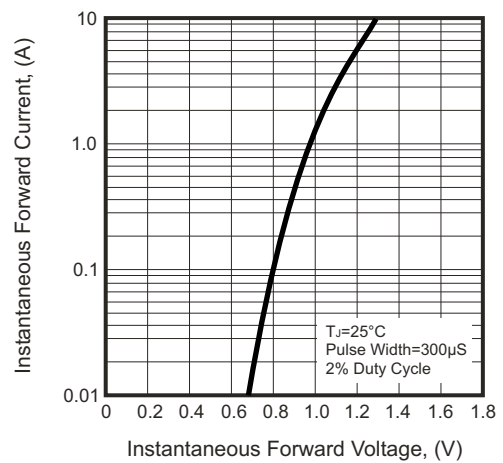
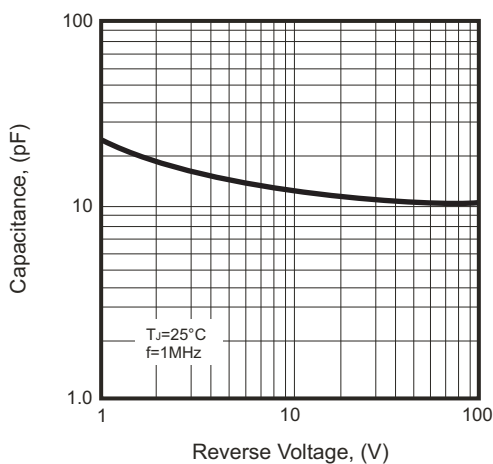
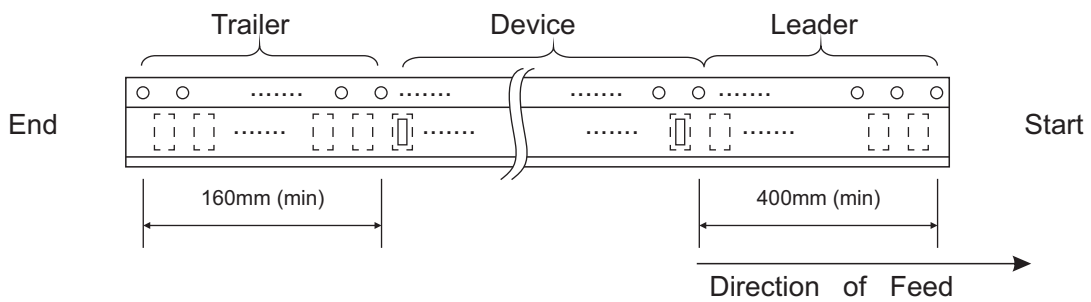
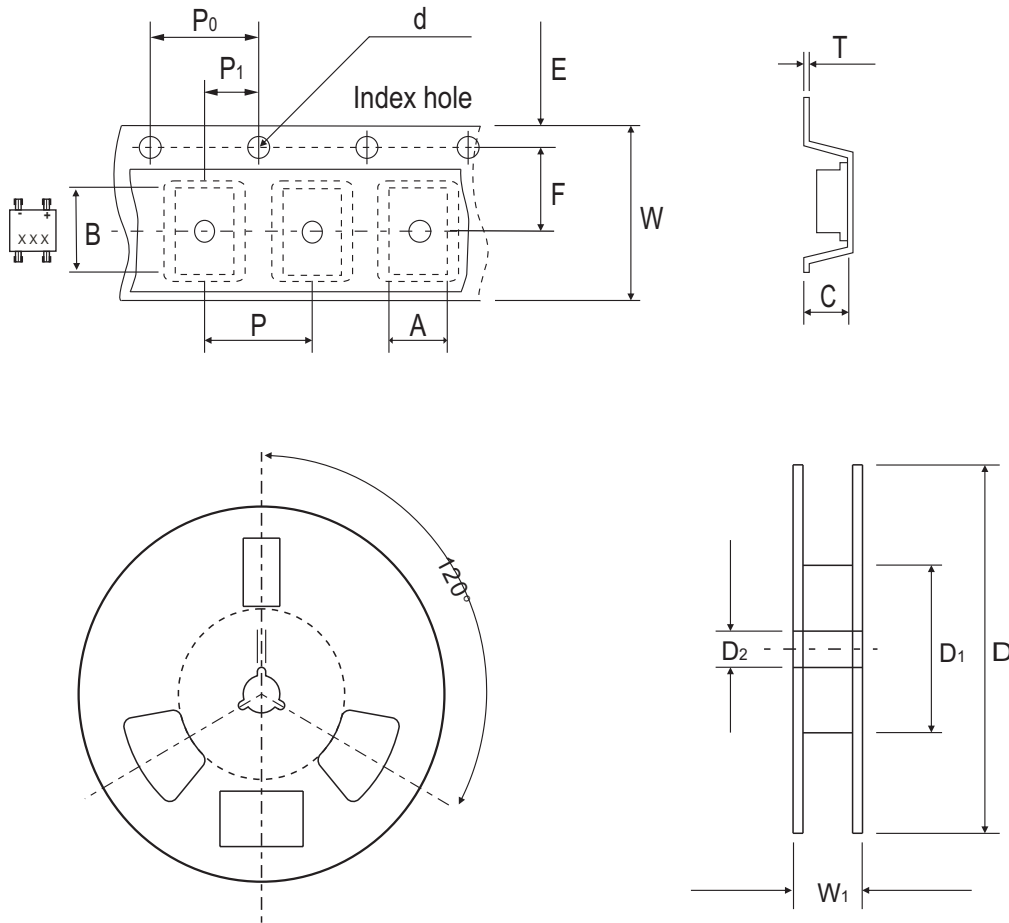

Fig.5 - Typical Junction Capacitance



Company reserves the right to improve product design, functions and reliability without notice.

Reel Taping Specification



MBS	SYMBOL	A	B	C	d	D	D ₁	D ₂
	(mm)	4.90 ± 0.10	7.24 ± 0.10	3.33 ± 0.10	1.55 ± 0.05	330	50.0 MIN.	13.00 ± 0.20
	(inch)	0.193 ± 0.004	0.285 ± 0.004	0.131 ± 0.004	0.061 ± 0.002	13	1.969 MIN.	0.512 ± 0.008

MBS	SYMBOL	E	F	P	P ₀	P ₁	T	W	W ₁
	(mm)	1.75 ± 0.10	5.50 ± 0.05	8.00 ± 0.10	4.00 ± 0.10	2.00 ± 0.05	0.30	12.00 ± 0.30	12.00~14.40
	(inch)	0.069 ± 0.004	0.217 ± 0.002	0.315 ± 0.004	0.157 ± 0.004	0.079 ± 0.002	0.012	0.472 ± 0.012	0.472~0.657

Company reserves the right to improve product design, functions and reliability without notice.

Marking Code

Part Number	Marking code
B05S-HF	B05S
B1S-HF	B1S
B2S-HF	B2S
B4S-HF	B4S
B6S-HF	B6S
B8S-HF	B8S
B10S-HF	B10S

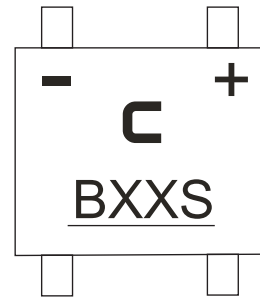

X / XX = Product type marking code

Suggested PAD Layout

SIZE	MBS	
	(mm)	(inch)
A	0.82MIN	0.032MIN
B	2.55REF	0.100REF
C	0.92MIN	0.036MIN
D	7.00MAX	0.276MAX

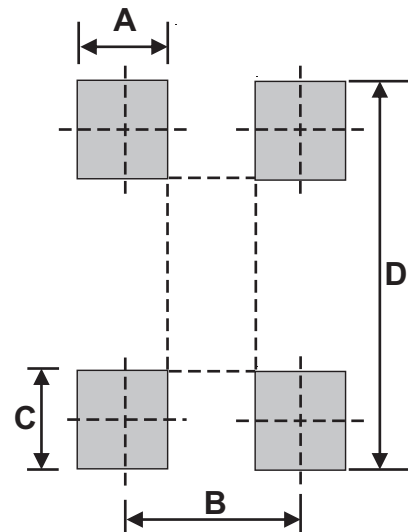

Standard Packaging

Case Type	REEL PACK	
	REEL (pcs)	Reel Size (inch)
MBS	3,000	13

Данный компонент на территории Российской Федерации

Вы можете приобрести в компании MosChip.

Для оперативного оформления запроса Вам необходимо перейти по данной ссылке:

<http://moschip.ru/get-element>

Вы можете разместить у нас заказ для любого Вашего проекта, будь то серийное производство или разработка единичного прибора.

В нашем ассортименте представлены ведущие мировые производители активных и пассивных электронных компонентов.

Нашей специализацией является поставка электронной компонентной базы двойного назначения, продукции таких производителей как XILINX, Intel (ex.ALTERA), Vicor, Microchip, Texas Instruments, Analog Devices, Mini-Circuits, Amphenol, Glenair.

Сотрудничество с глобальными дистрибьюторами электронных компонентов, предоставляет возможность заказывать и получать с международных складов практически любой перечень компонентов в оптимальные для Вас сроки.

На всех этапах разработки и производства наши партнеры могут получить квалифицированную поддержку опытных инженеров.

Система менеджмента качества компании отвечает требованиям в соответствии с ГОСТ Р ИСО 9001, ГОСТ РВ 0015-002 и ЭС РД 009

Офис по работе с юридическими лицами:

105318, г.Москва, ул.Щербаковская д.3, офис 1107, 1118, ДЦ «Щербаковский»

Телефон: +7 495 668-12-70 (многоканальный)

Факс: +7 495 668-12-70 (доб.304)

E-mail: info@moschip.ru

Skype отдела продаж:

moschip.ru

moschip.ru_4

moschip.ru_6

moschip.ru_9