

T591, T598, T597, and T599 High Humidity and High Temperature Automotive Grade Polymer Electrolytic, 2.5 – 50 VDC

Overview

KO-CAP Polymer Capacitors

The KEMET Organic Capacitor (KO-CAP) is a solid electrolytic capacitor with a conductive polymer cathode, capable of delivering very low ESR and an improved capacitance retention at high frequencies. KO-CAP combines the low ESR of the multilayer ceramic, the high capacitance of aluminum electrolytic and the volumetric efficiency of tantalum into a single surface mount package. Unlike liquid electrolyte-based capacitors, KO-CAP has a very long operational life and a high ripple current capabilities.

The T591/T597/T598/T599 High Humidity and High Temperature Polymer Electrolytic capacitors deliver higher capacitance and ESR stability under harsh environmental conditions. Enhancements to the design and selected material upgrades were introduced to deliver 500 hours (T591) or 1,000 hours (T598, T599) at 85°C/85% RH rated voltage and to fully comply with the AEC-Q200 qualification testing with maximum operational temperature life up to 125°C and 150°C respectively. These capacitors are manufactured in an ISO TS 16949 certified plants and are subjected to PPAP/PSW, as well as change control.

Benefits

- Ultra low ESR
- Full compliance with AEC-Q200 qualification test plan (T597 FD 125°C, T598 125°C, T599 150°C)
- Qualification plan based on AEC-Q200 with 85°C/85% RH load specification limited to 500 hours (T591)
- Extended endurance test qualification for T598/T599 ($V_R < 16\text{ V}$), up to 2,000 hours 125°C
- TS 16949 certified plants
- Subject to PPAP/PSW and change control
- Meets or exceeds EIA standard 535BAAC
- Tape & Reel standard packaging per EIA 481
- Halogen-free epoxy and RoHS compliant

Applications

Typical applications include decoupling and filtering in a variety of market segments, with special emphasis in automotive applications such as infotainment, ADAS, chassis and safety, as well as powertrain, where harsh conditions, such as high humidity and temperature, are a concern.

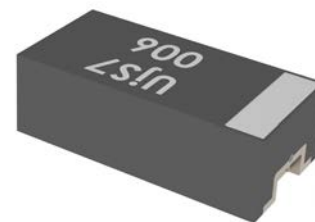
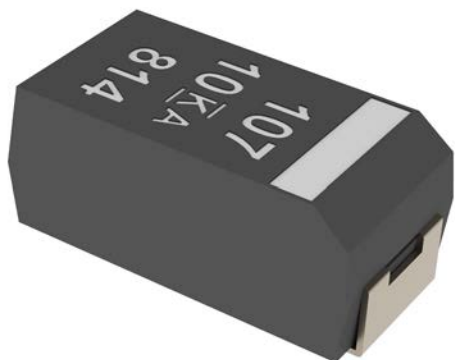

K-SIM

For a detailed analysis of specific part numbers, please visit ksim.kemet.com to access KEMET's K-SIM software. KEMET K-SIM is designed to simulate behavior of components with respect to frequency, ambient temperature, and DC bias levels.

Ordering Information

Standard Construction

T	59X	D	107	M	010	A	T	E025	
Capacitor Class	Series	Case Size	Capacitance Code (pF)	Capacitance Tolerance	Rated Voltage (VDC)	Failure Rate/Design	Termination Finish	ESR	Packaging (C-Spec)
T = Tantalum	591 = 500 Hours load humidity 598 = AEC-Q200 qualified (125°C) 599 = AEC-Q200 qualified (150°C)	B D V X	First two digits represent significant figures. Third digit specifies number of zeros.	M = ±20% K = ±10%	2R5 = 2.5 006 = 6.3 010 = 10 016 = 16 020 = 20 025 = 25 035 = 35 050 = 50	A = N/A	T = 100% Tin (Sn)	Maximum ESR in mΩ, 025 = 25 mΩ	Blank = 7" Reel 7280 = 13" Reel

Face Down Construction

T	597	S	476	M	006	A	P	E200	
Capacitor Class	Series	Case Size	Capacitance Code (pF)	Capacitance Tolerance	Rated Voltage (VDC)	Failure Rate/Design	Termination Finish	ESR	Packaging (C-Spec)
T = Tantalum	597 = AEC-Q200 qualified (125°C) face down construction	P S	First two digits represent significant figures. Third digit specifies number of zeros.	M = ±20%	2R5 = 2.5 006 = 6.3 010 = 10	A = N/A	P = Ni-Pd-Au	Maximum ESR in mΩ, 200 = 200 mΩ	Blank = 7" Reel

Performance Characteristics

Item	Performance Characteristics
Operating Temperature	-55°C to 105°C/125°C/150°C
Rated Capacitance Range	10 – 470 µF at 120 Hz/25°C
Capacitance Tolerance	K Tolerance (10%), M Tolerance (20%)
Rated Voltage Range	2.5 – 50 V
DF (120 Hz)	Refer to Part Number Electrical Specification Table
ESR (100 kHz)	Refer to Part Number Electrical Specification Table
Leakage Current	≤ 0.1 CV (µA) at rated voltage after 5 minutes T597: ≤ 0.3 CV (µA) at rated voltage after 5 minutes

Environmental Compliance

RoHS compliant (6/6) according to Directive 2002/95/EC when ordered with 100% Sn solder. Halogen-free.

Qualification

Test	Condition	Characteristics				
Endurance	105°C at rated voltage, 2,000 hours 125°C at 2/3 rated voltage, 2,000 hours* ² 150°C at 2/3 rated voltage, 1,000 hours (T599, $V_R > 16$ V) 150°C at 2/3 rated voltage, 2,000 hours (T599, $V_R < 16$ V)	Δ C/C	Within -20%/+10% of initial value			
		DF	Within 2 x initial limit			
		DCL	Within 2 x initial limit			
		ESR	Within 2 x initial limit			
Storage Life	105°C at 0 volts, 2,000 hours 125°C at 0 volts, 1,000 hours* ² 150°C at 0 volts, 1,000 hours (T599)	Δ C/C	Within -20%/+10% of initial value			
		DF	Within 2 x initial limit			
		DCL	Within 2 x initial limit			
		ESR	Within 2 x initial limit			
Humidity	85°C, 85% RH, load, 500 hours (T591) 85°C, 85% RH, load, 1,000 hours (T597, T598, T599)	Δ C/C	Within -5%/+35% of initial value			
		DF	Within 1.5 x initial limits			
		DCL	Within initial limit			
		ESR	Within 2 x initial limit			
Moisture Resistance* ¹	MIL-STD-202, Method 106, 65°C, 90 – 100% RH, no load, 10 cycles	Δ C/C	Within -10%/+20% of initial value			
		DF	Within initial limit			
		DCL	Within initial limit			
		ESR	Within 2 x initial limit			
Temperature Cycling	JESD22, Test Method A104, -55°C to +105°C/+125°C/+150°C* ² , 1,000 cycles	Δ C/C	Within -20%/+10% of initial value			
		DF	Within initial limits			
		DCL	Within initial limit			
		ESR	Within 2 x initial limits			
Surge Voltage	105°C, 1.32 x rated voltage, 1,000 cycles, 33 Ω in series 125°C/150°C, 1.32 x (0.67 x V_R), 1,000 cycles, 33 Ω in series* ²	Δ C/C	Within -20%/+10% of initial value			
		DF	Within initial limits			
		DCL	Within initial limits			
		ESR	Within initial limits			
Temperature Stability	Extreme temperature exposure at a succession of continuous steps at +25°C, -55°C, +25°C, +85°C, +105°C/+125°C/+150°C* ² , +25°C	Δ C/C	+25°C	-55°C	+85°C	+105°C/+125°C/+150°C* ²
		DF	IL* ³	±20%	±20%	±30%* ⁴
		DCL	IL	IL	1.2 x IL	1.5 x IL
Mechanical Shock/Vibration	AEC-Q200 (MIL-STD-202, Method 213, Figure 1, Condition F.)	Δ C/C	Within ±10% of initial value			
		DF	Within initial limits			
	AEC-Q200 (MIL-STD-202, Method 204, 5 G for 20 minutes/12 cycles each of 3 orientations. Test from 10 – 2,000 Hz.)	ESR	Within initial limits			
		DCL	Within initial limits			

*¹ T598 only

*² Refer to part number specifications for individual temperature classification

*³ IL = Initial limit

*⁴ For T599 (≤ 16 V) apply -30%/+40%

Reliability

KO-CAP capacitors have an average failure rate of 0.5 %/1,000 hours at category voltage, U_c , and category temperature, T_c . These capacitors are qualified using industry test standards at U_c and T_c . The minimum test time (1,000 hours or 2,000 hours) is dependent on the product.

The actual life expectancy of KO-CAP capacitors increases when application voltage, U_A , and application temperature, T_A , are lower than U_c and T_c . As a general guideline, when $U_A < 0.9 * U_c$ and $T_A < 85^\circ\text{C}$, the life expectancy will typically exceed the useful lifetime of most hardware (> 10 years).

The lifetime of a KO-CAP capacitor at a specific application voltage and temperature can be modeled using the equations below. A failure is defined as passing enough current to blow a 1-amp fuse. The calculation is an estimation based on empirical results and is not a guarantee.

$$VAF = \left(\frac{U_c}{U_A}\right)^n$$

where:
 VAF = acceleration factor due to voltage, unitless
 U_c = category voltage, volt
 U_A = application voltage, volt
 n = exponent, 16

$$TAF = e^{\left[\frac{E_a}{k} \left(\frac{1}{273+T_A} - \frac{1}{273+T_c}\right)\right]}$$

where:
 TAF = acceleration factor due to temperature, unitless
 E_a = activation energy, 1.4 eV
 k = Boltzmann's constant, 8.617E-5 eV/K
 T_A = application temperature, °C
 T_c = category temperature, °C

$$AF = VAF * TAF$$

where:
 AF = acceleration factor, unitless
 TAF = acceleration factor due to temperature, unitless
 VAF = acceleration factor due to voltage, unitless

$$Life_{U_A, T_A} = Life_{U_c, T_c} * AF$$

where:
 $Life_{U_A, T_A}$ = guaranteed life application voltage and temperature, years
 $Life_{U_c, T_c}$ = guaranteed life category voltage and temperature, years
 AF = acceleration factor, unitless

Reliability Table 1 – Common Temperature Range Classifications														
85°C (T_R)/ 85°C (T_c)	Rated voltage (U_R)	2.5	4.0	6.3	8.0	10.0	12.5	16.0	20.0	25.0	35.0	50.0	63.0	75.0
	Category voltage (U_c)	2.5	4.0	6.3	8.0	10.0	12.5	16.0	20.0	25.0	35.0	50.0	63.0	75.0
105°C (T_R)/ 105°C (T_c)	Rated voltage (U_R)	2.5	4.0	6.3	8.0	10.0	12.5	16.0	20.0	25.0	35.0	50.0	63.0	75.0
	Category voltage (U_c)	2.5	4.0	6.3	8.0	10.0	12.5	16.0	20.0	25.0	35.0	50.0	63.0	75.0
105°C (T_R)/ 125°C (T_c)	Rated voltage (U_R)	2.5	4.0	6.3	8.0	10.0	12.5	16.0	20.0	25.0	35.0	50.0	63.0	75.0
	Category voltage (U_c)	1.7	2.7	4.2	5.4	6.7	8.4	10.7	13.4	16.8	23.5	33.5	42.2	50.3
105°C (T_R)/ 150°C (T_c)	Rated voltage (U_R)	2.5	4.0	6.3	8.0	10.0	12.5	16.0	20.0	25.0	35.0	50.0	63.0	75.0
	Category voltage (U_c)	1.7	2.7	4.2	5.4	6.7	8.4	10.7	13.4	16.8	23.5	33.5	42.2	50.3

Terms:

Category voltage, U_c : Maximum recommended peak DC operating voltage for continuous operation at the category temperature, T_c .
 Rated voltage, U_R : Maximum recommended peak DC operating voltage for continuous operation up to the rated temperature, T_R .
 Category temperature, T_c : Maximum recommended operating temperature. Voltage derating may be required at T_c .
 Rated temperature, T_R : Maximum recommended operating temperature without voltage derating. T_R is equal to or lower than T_c .

Certification

KEMET's internal qualification plan for this polymer electrolytic series of capacitors follows AEC-Q200 guidelines.

For T591 the humidity bias is limited to a maximum of 500 hours.

For T597 and T598 the qualification plan is fully compliant with AEC-Q200 with maximum operational temperature of 125°C.

For T599 the qualification plan is fully compliant with AEC-Q200 with maximum operational temperature of 150°C.

Electrical Characteristics

ESR vs. Frequency – T591

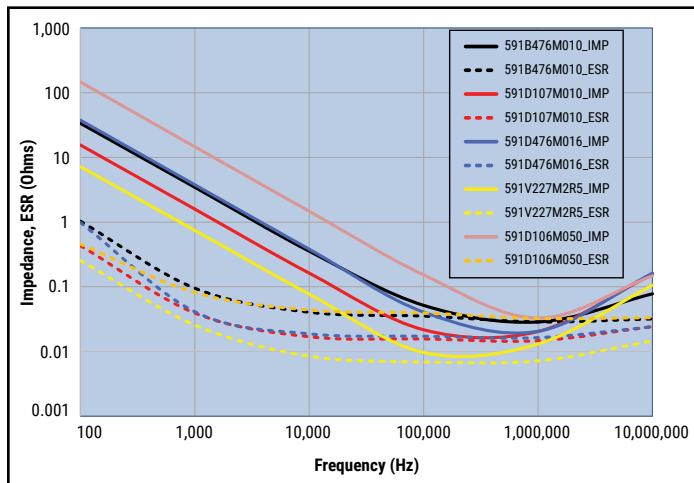

Capacitance vs. Frequency – T591

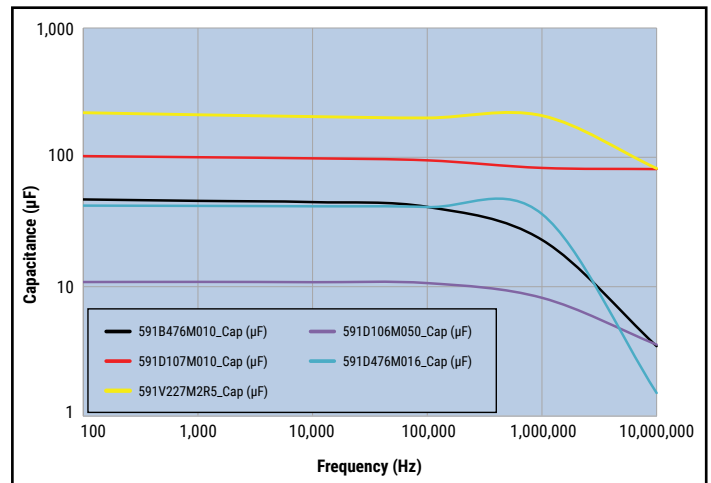

ESR vs. Frequency – T597

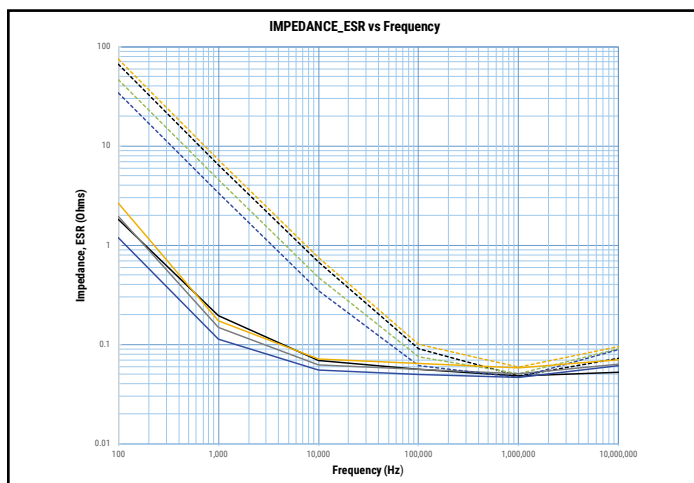

Capacitance vs. Frequency – T597

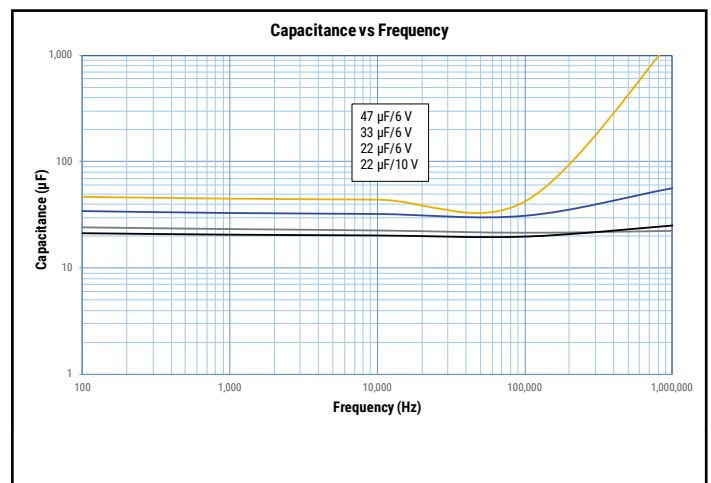

Electrical Characteristics cont.

ESR vs. Frequency – T598

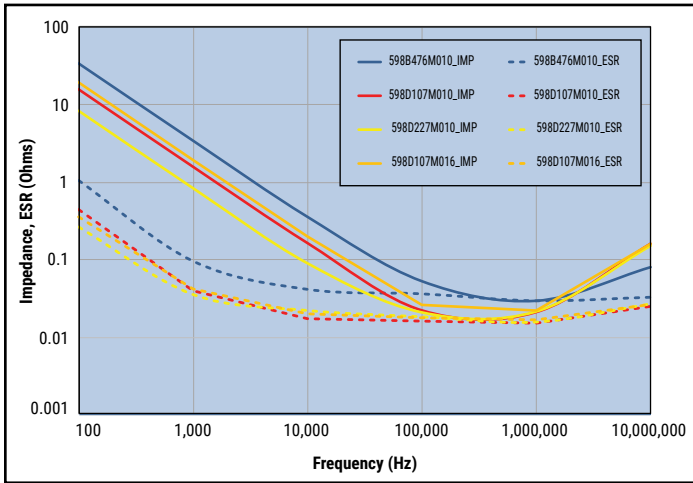

Capacitance vs. Frequency – T598

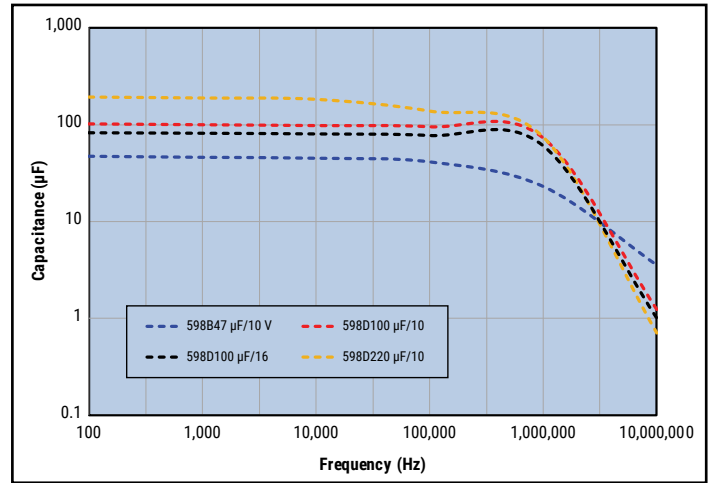

ESR vs. Frequency – T599

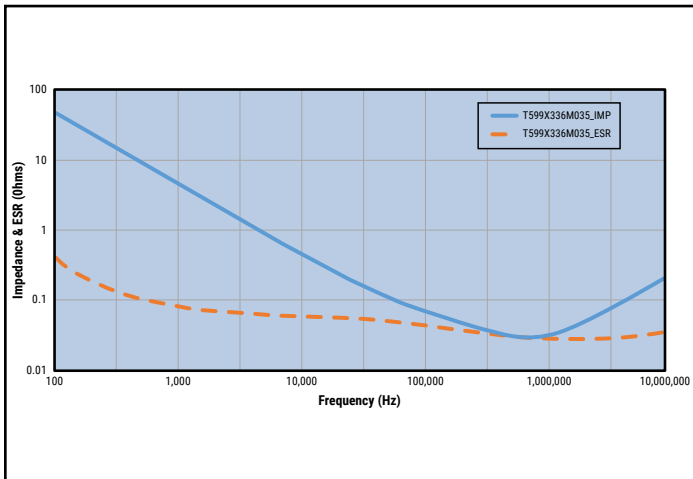

Capacitance vs. Frequency – T599

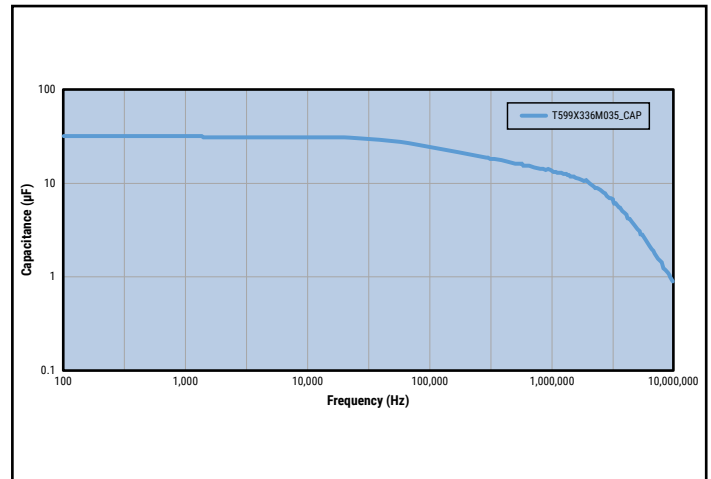

Dimensions – Millimeters (Inches)

Metric will govern

T591 / T598 / T599

CATHODE (-) END VIEW

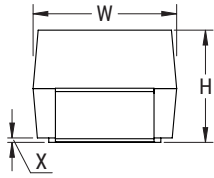

SIDE VIEW

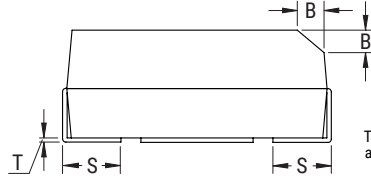

ANODE (+) END VIEW

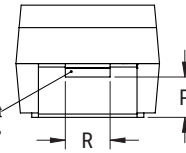

BOTTOM VIEW

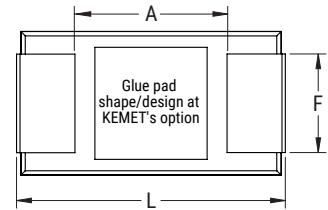

Termination cutout at KEMET's option, either end

Case Size		Component Dimensions											Typical Weight
KEMET	EIA	L	W	H	F ±0.1 ±(0.004)	S ±0.3 ±(0.012)	B ±0.15 (Ref) ±0.006	X (Ref)	P (Ref)	R (Ref)	T (Ref)	A (Minimum)	(mg)
B	3528-21	3.5 ±0.2 (0.138 ±0.008)	2.8 ±0.2 (0.110 ±0.008)	1.9 ±0.2 (0.075 ±0.008)	2.2 (0.087)	0.8 (0.031)	0.4 (0.016)	0.10 ±0.10 (0.004 ±0.004)	0.5 (0.020)	1.0 (0.039)	0.13 (0.005)	1.1 (0.043)	95
D	7343-31	7.3 ±0.3 (0.287 ±0.012)	4.3 ±0.3 (0.169 ±0.012)	2.8 ±0.3 (0.110 ±0.012)	2.4 (0.094)	1.3 (0.051)	0.5 (0.020)	0.10 ±0.10 (0.004 ±0.004)	0.9 (0.035)	1.0 (0.039)	0.13 (0.005)	3.8 (0.150)	435
V	7343-20	7.3 ±0.3 (0.287 ±0.012)	4.3 ±0.3 (0.169 ±0.012)	1.9 ±0.1 (0.075 ±0.004)	2.4 (0.094)	1.3 (0.051)	N/A	0.05 (0.002)	N/A	N/A	0.13 (0.005)	3.8 (0.150)	274
X	7343-43	7.3 ±0.3 (0.287 ±0.012)	4.3 ±0.3 (0.169 ±0.012)	4.0 ±0.3 (0.157 ±0.012)	2.4 (0.094)	1.3 (0.051)	0.5 (0.020)	0.10 ±0.10 (0.004 ±0.004)	1.7 (0.067)	1.0 (0.039)	0.13 (0.005)	3.8 (0.150)	554

Notes: Reference (Ref) – Dimensions provided for reference only. For low profile cases, no dimensions are provided for B, P, or R, because these cases do not have a bevel or a notch.

These weights are provided as reference. If exact weights are needed, please contact your KEMET sales representative.

T597

END VIEW

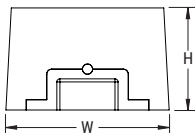

SIDE VIEW

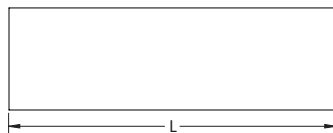

BOTTOM VIEW

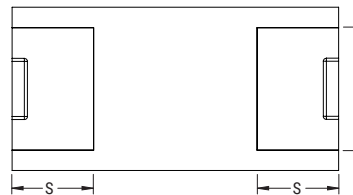

Case Size		Component Dimensions					Weight
KEMET	EIA	L	W	H	F ±0.1 (±0.004)	S ±0.2 (±0.008)	(mg)
P	2012-10	2.0 ±0.2 (0.079 ±0.008)	1.2 ±0.2 (0.047 ±0.008)	0.9 ±0.1 (0.035 ±0.004)	0.9 (0.035)	0.55 (0.022)	11.3
S	3216-12	3.2 ±0.2 (0.126 ±0.008)	1.6 ±0.2 (0.063 ±0.008)	1.1 ±0.1 (0.043 ±0.004)	1.2 (0.047)	0.8 (0.031)	26.2

Table 1 – Ratings & Part Number Reference

Rated Voltage	Rated Cap	Case Code/ Case Size	KEMET Part Number	DC Leakage	DF	ESR	Maximum Allowable Ripple Current	MSL	Maximum Operating Temp	AEC-Q200 Qualified
VDC at 105°C	µF	KEMET/EIA		µA at +25°C Max/5 Minutes	% at +25°C 120 Hz Max	mΩ at +25°C 100 kHz Max	(rms) mA at +45°C 100 kHz	Reflow Temp ≤ 260°C	°C	T598/T599 Only ¹
105°C										
2.5	100	B/3528-21	T591B107M2R5ATE055	25	8	55	1,520	3	105	
2.5	100	B/3528-21	T591B107M2R5ATE070	25	8	70	1,347	3	105	
2.5	220	B/3528-21	T591B227M2R5ATE025	55	8	25	2,260	3	105	
2.5	220	V/7343-20	T591V227M2R5ATE009	55	10	9	4,558	3	105	
2.5	220	V/7343-20	T591V227M2R5ATE012	55	10	12	3,947	3	105	
2.5	220	V/7343-20	T591V227M2R5ATE015	55	10	15	3,531	3	105	
2.5	470	D/7343-31	T591D477M2R5ATE009	117.5	10	9	5,000	3	105	
4	100	B/3528-21	T591B107M004ATE070	40	10	70	1,347	3	105	
4	220	V/7343-20	T591V227M004ATE018	88	10	18	3,223	3	105	
4	220	V/7343-20	T591V227M004ATE025	88	10	25	2,735	3	105	
6.3	220	B/3528-21	T591B227M006ATE035	139	8	35	1,900	3	105	
125°C										
2.5	100	B/3528-21	T598B107M2R5ATE055	25	8	55	1,520	3	125	•
2.5	100	B/3528-21	T598B107M2R5ATE070	25	8	70	1,347	3	125	•
2.5	330	V/7343-20	T591V337M2R5ATE012	82.5	10	12	3,947	3	125	
2.5	330	V/7343-20	T591V337M2R5ATE025	82.5	10	25	2,735	3	125	
2.5	330	D/7343-31	T591D337M2R5ATE015	82.5	10	15	3,873	3	125	
2.5	330	D/7343-31	T591D337M2R5ATE018	82.5	10	18	3,536	3	125	
2.5	470	D/7343-31	T598D477M2R5ATE009	117.5	10	9	5,000	3	125	•
4	100	B/3528-21	T598B107M004ATE045	40	10	45	1,680	3	125	•
4	100	B/3528-21	T598B107M004ATE055	40	10	55	1,520	3	125	•
4	100	B/3528-21	T598B107M004ATE070	40	10	70	1,347	3	125	•
4	100	B/3528-21	T591B107M004ATE045	40	8	45	1,680	3	125	
4	100	B/3528-21	T591B107M004ATE055	40	8	55	1,520	3	125	
4	150	B/3528-21	T598B157M004ATE045	60	8	45	1,680	3	125	•
4	150	B/3528-21	T598B157M004ATE055	60	8	55	1,520	3	125	•
4	150	B/3528-21	T598B157M004ATE070	60	8	70	1,347	3	125	•
4	150	B/3528-21	T591B157M004ATE045	60	8	45	1,680	3	125	
4	150	B/3528-21	T591B157M004ATE055	60	8	55	1,520	3	125	
4	150	B/3528-21	T591B157M004ATE070	60	8	70	1,347	3	125	
4	330	V/7343-20	T598V337M004ATE025	132	10	25	2,735	3	125	•
4	330	V/7343-20	T598V337M004ATE045	132	10	45	2,039	3	125	•
4	330	V/7343-20	T591V337M004ATE025	132	10	25	2,735	3	125	
4	330	V/7343-20	T591V337M004ATE045	132	10	45	2,039	3	125	
6.3	33	B/3528-21	T598B336M006ATE070	20.8	8	70	1,347	3	125	•
6.3	33	B/3528-21	T598B336M006ATE080	20.8	8	80	1,260	3	125	•
6.3	33	B/3528-21	T591B336M006ATE070	20.8	8	70	1,347	3	125	
6.3	33	B/3528-21	T591B336M006ATE080	20.8	8	80	1,260	3	125	
6.3	47	B/3528-21	T598B476M006ATE070	29.6	8	70	1,347	3	125	•
6.3	47	B/3528-21	T591B476M006ATE070	29.6	8	70	1,347	3	125	
6.3	68	B/3528-21	T598B686M006ATE070	43	8	70	1,347	3	125	•
6.3	68	B/3528-21	T591B686M006ATE070	43	8	70	1,347	3	125	
6.3	100	B/3528-21	T598B107M006ATE045	63	8	45	1,680	3	125	•
6.3	100	B/3528-21	T598B107M006ATE055	63	8	55	1,520	3	125	•
6.3	100	B/3528-21	T598B107M006ATE070	63	8	70	1,347	3	125	•
6.3	100	B/3528-21	T591B107M006ATE045	63	8	45	1,680	3	125	
6.3	100	B/3528-21	T591B107M006ATE055	63	8	55	1,520	3	125	
6.3	100	B/3528-21	T591B107M006ATE070	63	8	70	1,347	3	125	
6.3	150	B/3528-21	T598B157M006ATE045	94.5	8	45	1,680	3	125	•
VDC at 105°C	µF	KEMET/EIA		µA at +25°C Max/5 Minutes	% at +25°C 120 Hz Max	mΩ at +25°C 100 kHz Max	mA at +45°C 100 kHz	Reflow Temp ≤ 260°C	°C	T598/T599 Only ¹
Rated Voltage	Rated Cap	Case Code/ Case Size	KEMET Part Number	DC Leakage	DF	ESR	Maximum Allowable Ripple Current	MSL	Maximum Operating Temp	AEC-Q200 Qualified

(1) To complete KEMET part number, insert M for ±20% or K for ±10%. Designates capacitance tolerance.
¹ T598 = AEC-Q200 qualified. T599 AEC-Q200 qualified 150°C and T591 = limited to 500 hours at 85°C/85% RH load.
 Refer to Ordering Information for additional detail.

Table 1 – Ratings & Part Number Reference cont.

Rated Voltage	Rated Cap	Case Code/ Case Size	KEMET Part Number	DC Leakage	DF	ESR	Maximum Allowable Ripple Current	MSL	Maximum Operating Temp	AEC-Q200 Qualified
VDC at 105°C	µF	KEMET/EIA		µA at +25°C Max/5 Minutes	% at +25°C 120 Hz Max	mΩ at +25°C 100 kHz Max	(rms) mA at +45°C 100 kHz	Reflow Temp ≤ 260°C	°C	T598/T599 Only ¹
125°C										
6.3	150	B/3528-21	T598B157M006ATE055	94.5	8	55	1,520	3	125	•
6.3	150	B/3528-21	T598B157M006ATE070	94.5	8	70	1,347	3	125	•
6.3	150	B/3528-21	T591B157M006ATE045	94.5	8	45	1,680	3	125	
6.3	150	B/3528-21	T591B157M006ATE055	94.5	8	55	1,520	3	125	
6.3	150	B/3528-21	T591B157M006ATE070	94.5	8	70	1,347	3	125	
6.3	150	V/7343-20	T598V157M006ATE025	94.5	10	25	2,735	3	125	•
6.3	150	V/7343-20	T598V157M006ATE045	94.5	10	45	2,039	3	125	•
6.3	150	V/7343-20	T591V157M006ATE025	94.5	10	25	2,735	3	125	
6.3	150	V/7343-20	T591V157M006ATE045	94.5	10	45	2,039	3	125	
6.3	150	D/7343-31	T598D157M006ATE025	94.5	10	25	3,000	3	125	•
6.3	150	D/7343-31	T598D157M006ATE045	94.5	10	45	2,236	3	125	•
6.3	150	D/7343-31	T591D157M006ATE025	94.5	10	25	3,000	3	125	
6.3	150	D/7343-31	T591D157M006ATE045	94.5	10	45	2,236	3	125	
6.3	220	B/3528-21	T591B227M006ATE045	139	8	45	1,680	3	125	
6.3	220	B/3528-21	T591B227M006ATE070	139	8	70	1,347	3	125	
6.3	220	D/7343-31	T598D227M006ATE025	139	10	25	3,000	3	125	•
6.3	220	D/7343-31	T598D227M006ATE040	139	10	40	2,372	3	125	•
6.3	220	D/7343-31	T598D227M006ATE080	139	10	80	1,677	3	125	•
6.3	220	D/7343-31	T591D227M006ATE025	139	10	25	3,000	3	125	
6.3	220	D/7343-31	T591D227M006ATE040	139	10	40	2,372	3	125	
6.3	220	D/7343-31	T591D227M006ATE080	139	10	80	1,677	3	125	
6.3	220	V/7343-20	T598V227M006ATE025	139	10	25	2,735	3	125	•
6.3	220	V/7343-20	T598V227M006ATE045	139	10	45	2,039	3	125	•
6.3	220	V/7343-20	T591V227M006ATE025	139	10	25	2,735	3	125	
6.3	220	V/7343-20	T591V227M006ATE045	139	10	45	2,039	3	125	
6.3	330	D/7343-31	T598D337M006ATE025	208	10	25	3,000	3	125	•
6.3	330	D/7343-31	T598D337M006ATE040	208	10	40	2,372	3	125	•
6.3	330	D/7343-31	T598D337M006ATE080	208	10	80	1,677	3	125	•
6.3	330	D/7343-31	T591D337M006ATE025	208	10	25	3,000	3	125	
6.3	330	D/7343-31	T591D337M006ATE040	208	10	40	2,372	3	125	
6.3	330	D/7343-31	T591D337M006ATE080	208	10	80	1,677	3	125	
10	33	B/3528-21	T598B336M010ATE070	33	8	70	1,347	3	125	•
10	33	B/3528-21	T598B336M010ATE080	33	8	80	1,260	3	125	•
10	33	B/3528-21	T591B336M010ATE070	33	8	70	1,347	3	125	
10	33	B/3528-21	T591B336M010ATE080	33	8	80	1,260	3	125	
10	47	B/3528-21	T598B476M010ATE070	47	8	70	1,347	3	125	•
10	47	B/3528-21	T591B476M010ATE070	47	8	70	1,347	3	125	
10	100	D/7343-31	T598D107M010ATE025	100	10	25	3,000	3	125	•
10	100	D/7343-31	T598D107M010ATE040	100	10	40	2,372	3	125	•
10	100	D/7343-31	T598D107M010ATE080	100	10	80	1,677	3	125	•
10	100	D/7343-31	T591D107M010ATE025	100	10	25	3,000	3	125	
10	100	D/7343-31	T591D107M010ATE040	100	10	40	2,372	3	125	
10	100	D/7343-31	T591D107M010ATE080	100	10	80	1,677	3	125	
10	100	V/7343-20	T598V107M010ATE025	100	10	25	2,735	3	125	•
10	100	V/7343-20	T598V107M010ATE045	100	10	45	2,039	3	125	•
10	100	V/7343-20	T591V107M010ATE025	100	10	25	2,735	3	125	
10	100	V/7343-20	T591V107M010ATE045	100	10	45	2,039	3	125	
10	150	D/7343-31	T598D157M010ATE025	150	10	25	3,000	3	125	•
10	150	D/7343-31	T598D157M010ATE045	150	10	45	2,236	3	125	•
VDC at 105°C	µF	KEMET/EIA		µA at +25°C Max/5 Minutes	% at +25°C 120 Hz Max	mΩ at +25°C 100 kHz Max	mA at +45°C 100 kHz	Reflow Temp ≤ 260°C	°C	T598/T599 Only ¹
Rated Voltage	Rated Cap	Case Code/ Case Size	KEMET Part Number	DC Leakage	DF	ESR	Maximum Allowable Ripple Current	MSL	Maximum Operating Temp	AEC-Q200 Qualified

(1) To complete KEMET part number, insert M for ±20% or K for ±10%. Designates capacitance tolerance.

¹ T598 = AEC-Q200 qualified. T599 AEC-Q200 qualified 150°C and T591 = limited to 500 hours at 85°C/85% RH load.

Refer to Ordering Information for additional detail.

Table 1 – Ratings & Part Number Reference cont.

Rated Voltage	Rated Cap	Case Code/ Case Size	KEMET Part Number	DC Leakage	DF	ESR	Maximum Allowable Ripple Current	MSL	Maximum Operating Temp	AEC-Q200 Qualified
VDC at 105°C	µF	KEMET/EIA		µA at +25°C Max/5 Minutes	% at +25°C 120 Hz Max	mΩ at +25°C 100 kHz Max	(rms) mA at +45°C 100 kHz	Reflow Temp ≤ 260°C	°C	T598/T599 Only ¹
125°C										
10	150	D/7343-31	T591D157M010ATE025	150	10	25	3,000	3	125	
10	150	D/7343-31	T591D157M010ATE045	150	10	45	2,236	3	125	
10	150	V/7343-20	T598V157M010ATE025	150	10	25	2,735	3	125	•
10	150	V/7343-20	T598V157M010ATE045	150	10	45	2,236	3	125	•
10	150	V/7343-20	T591V157M010ATE025	150	10	25	2,735	3	125	
10	150	V/7343-20	T591V157M010ATE045	150	10	45	2,236	3	125	
10	220	D/7343-31	T598D227M010ATE025	220	10	25	3,000	3	125	•
10	220	D/7343-31	T598D227M010ATE040	220	10	40	2,372	3	125	•
10	220	D/7343-31	T598D227M010ATE080	220	10	80	1,677	3	125	•
10	220	D/7343-31	T591D227M010ATE025	220	10	25	3,000	3	125	
10	220	D/7343-31	T591D227M010ATE040	220	10	40	2,372	3	125	
10	220	D/7343-31	T591D227M010ATE080	220	10	80	1,677	3	125	
16	47	D/7343-31	T598D476M016ATE070	75.2	10	70	1,793	3	125	•
16	47	D/7343-31	T591D476M016ATE070	75.2	10	70	1,793	3	125	
16	100	D/7343-31	T598D107M016ATE050	160	10	50	2,121	3	125	•
16	100	D/7343-31	T591D107M016ATE050	160	10	50	2,121	3	125	
16	150	D/7343-31	T598D157M016ATE065	240	10	65	1,900	3	125	•
16	150	D/7343-31	T591D157M016ATE065	240	10	65	1,900	3	125	
20	47	D/7343-31	T591D476M020ATE050	94	10	50	2,121	3	125	
20	68	D/7343-31	T591D686M020ATE040	136	10	40	2,372	3	125	
20	68	D/7343-31	T591D686M020ATE050	136	10	50	2,121	3	125	
25	22	D/7343-31	T591D226M025ATE060	55	10	60	1,936	3	125	
25	33	D/7343-31	T598D336M025ATE060	82.5	10	60	1,936	3	125	•
25	33	D/7343-31	T591D336M025ATE060	82.5	10	60	1,936	3	125	
25	47	D/7343-31	T598D476M025ATE060	117.5	10	60	1,936	3	125	•
35	2.2	B/3528-21	T598B225M035ATE150	7.7	8	150	920	3	125	•
35	2.2	B/3528-21	T591B225M035ATE150	7.7	8	150	920	3	125	
35	2.2	B/3528-21	T598B225M035ATE200	7.7	8	200	797	3	125	•
35	2.2	B/3528-21	T591B225M035ATE200	7.7	8	200	797	3	125	
35	3.3	B/3528-21	T598B335M035ATE150	11.6	8	150	920	3	125	•
35	3.3	B/3528-21	T591B335M035ATE150	11.6	8	150	920	3	125	
35	3.3	B/3528-21	T598B335M035ATE200	11.6	8	200	797	3	125	•
35	3.3	B/3528-21	T591B335M035ATE200	11.6	8	200	797	3	125	
35	4.7	B/3528-21	T598B475M035ATE200	16.5	8	200	797	3	125	•
35	4.7	B/3528-21	T591B475M035ATE200	16.5	8	200	797	3	125	
35	10	D/7343-31	T598D106M035ATE120	35	10	120	1,369	3	125	•
35	10	D/7343-31	T591D106M035ATE120	35	10	120	1,369	3	125	
35	10	V/7343-20	T598V106M035ATE120	35	10	120	1,248	3	125	•
35	10	V/7343-20	T591V106M035ATE120	35	10	120	1,248	3	125	
35	15	D/7343-31	T598D156M035ATE065	52.5	10	65	1,900	3	125	•
35	22	D/7343-31	T598D226M035ATE065	77	10	65	1,900	3	125	•
35	33	D/7343-31	T598D336M035ATE065	115.5	10	65	1,900	3	125	•
35	33	D/7343-31	T591D336M035ATE065	115.5	10	65	1,900	3	125	
35	33	X/7343-43	T598X336M035ATE065	115.5	10	65	1,949	3	125	•
50	1.5	B/3528-21	T598B155(1)050ATE200	7.5	8	200	797	3	125	•
50	1.5	B/3528-21	T591B155(1)050ATE200	7.5	8	200	797	3	125	
50	2.2	B/3528-21	T598B225M050ATE150	11	8	150	920	3	125	•
50	2.2	B/3528-21	T598B225M050ATE200	11	8	200	797	3	125	•
50	2.2	B/3528-21	T591B225M050ATE150	11	8	150	920	3	125	
VDC at 105°C	µF	KEMET/EIA		µA at +25°C Max/5 Minutes	% at +25°C 120 Hz Max	mΩ at +25°C 100 kHz Max	mA at +45°C 100 kHz	Reflow Temp ≤ 260°C	°C	T598/T599 Only ¹
Rated Voltage	Rated Cap	Case Code/ Case Size	KEMET Part Number	DC Leakage	DF	ESR	Maximum Allowable Ripple Current	MSL	Maximum Operating Temp	AEC-Q200 Qualified

(1) To complete KEMET part number, insert M for ±20% or K for ±10%. Designates capacitance tolerance.

¹ T598 = AEC-Q200 qualified. T599 AEC-Q200 qualified 150°C and T591 = limited to 500 hours at 85°C/85% RH load.

Refer to Ordering Information for additional detail.

Table 1 – Ratings & Part Number Reference cont.

Rated Voltage	Rated Cap	Case Code/ Case Size	KEMET Part Number	DC Leakage	DF	ESR	Maximum Allowable Ripple Current	MSL	Maximum Operating Temp	AEC-Q200 Qualified
VDC at 105°C	µF	KEMET/EIA		µA at +25°C Max/5 Minutes	% at +25°C 120 Hz Max	mΩ at +25°C 100 kHz Max	(rms) mA at +45°C 100 kHz	Reflow Temp ≤ 260°C	°C	T598/T599 Only ¹
125°C										
50	2.2	B/3528-21	T591B225M050ATE200	11	8	200	797	3	125	
50	10	D/7343-31	T598D106M050ATE090	50	10	90	1,581	3	125	•
50	10	D/7343-31	T591D106M050ATE090	50	10	90	1,581	3	125	
150°C										
4	33	B/3528-21	T599B336M004ATE070	13.2	8	70	1,347	3	150	•
4	33	B/3528-21	T599B336M004ATE090	13.2	8	90	1,188	3	150	•
4	47	B/3528-21	T599B476M004ATE070	18.8	8	70	1,347	3	150	•
4	47	B/3528-21	T599B476M004ATE090	18.8	8	90	1,188	3	150	•
4	68	B/3528-21	T599B686M004ATE070	27.2	8	70	1,347	3	150	•
4	68	B/3528-21	T599B686M004ATE090	27.2	8	90	1,188	3	150	•
4	150	D/7343-31	T599D157M004ATE025	60	10	25	3,000	3	150	•
4	150	D/7343-31	T599D157M004ATE045	60	10	45	2,236	3	150	•
6.3	33	B/3528-21	T599B336M006ATE070	20.8	8	70	1,347	3	150	•
6.3	33	B/3528-21	T599B336M006ATE090	20.8	8	90	1,188	3	150	•
6.3	47	B/3528-21	T599B476M006ATE070	29.6	8	70	1,347	3	150	•
6.3	47	B/3528-21	T599B476M006ATE090	29.6	8	90	1,188	3	150	•
6.3	150	D/7343-31	T599D157M006ATE025	94.5	10	25	3,000	3	150	•
6.3	150	D/7343-31	T599D157M006ATE045	94.5	10	45	2,236	3	150	•
10	33	B/3528-21	T599B336M010ATE070	33	8	70	1,347	3	150	•
10	33	B/3528-21	T599B336M010ATE090	33	8	90	1,188	3	150	•
10	33	B/3528-21	T599B336M010ATE150	33	8	150	920	3	150	•
35	33	X/7343-43	T599X336M035ATE065	115.5	10	65	1949	3	150	•
Facedown Construction										
2.5	100	S/3216-12	T597S107M2R5APE100	75	10	100	770	3	125	•
6.3	22	P/2012-10	T597P226M006APE200	41.6	10	200	354	3	125	•
6.3	33	S/3216-12	T597S336M006APE100	62.4	10	100	770	3	125	•
6.3	33	S/3216-12	T597S336M006APE200	62.4	10	200	570	3	125	•
6.3	47	S/3216-12	T597S476M006APE100	88.8	10	100	770	3	125	•
6.3	47	S/3216-12	T597S476M006APE200	88.8	10	200	570	3	125	•
10	22	S/3216-12	T597S226M010APE200	66	10	200	570	3	125	•
VDC at 105°C	µF	KEMET/EIA		µA at +25°C Max/5 Minutes	% at +25°C 120 Hz Max	mΩ at +25°C 100 kHz Max	mA at +45°C 100 kHz	Reflow Temp ≤ 260°C	°C	T598/T599 Only ¹
Rated Voltage	Rated Cap	Case Code/ Case Size	KEMET Part Number	DC Leakage	DF	ESR	Maximum Allowable Ripple Current	MSL	Maximum Operating Temp	AEC-Q200 Qualified

(1) To complete KEMET part number, insert M for ±20% or K for ±10%. Designates capacitance tolerance.

¹ T598 = AEC-Q200 qualified. T599 AEC-Q200 qualified 150°C and T591 = limited to 500 hours at 85°C/85% RH load.

Refer to Ordering Information for additional detail.

Part Numbers marked in blue font are "Under Development." Engineering samples available upon request.

Derating Guidelines

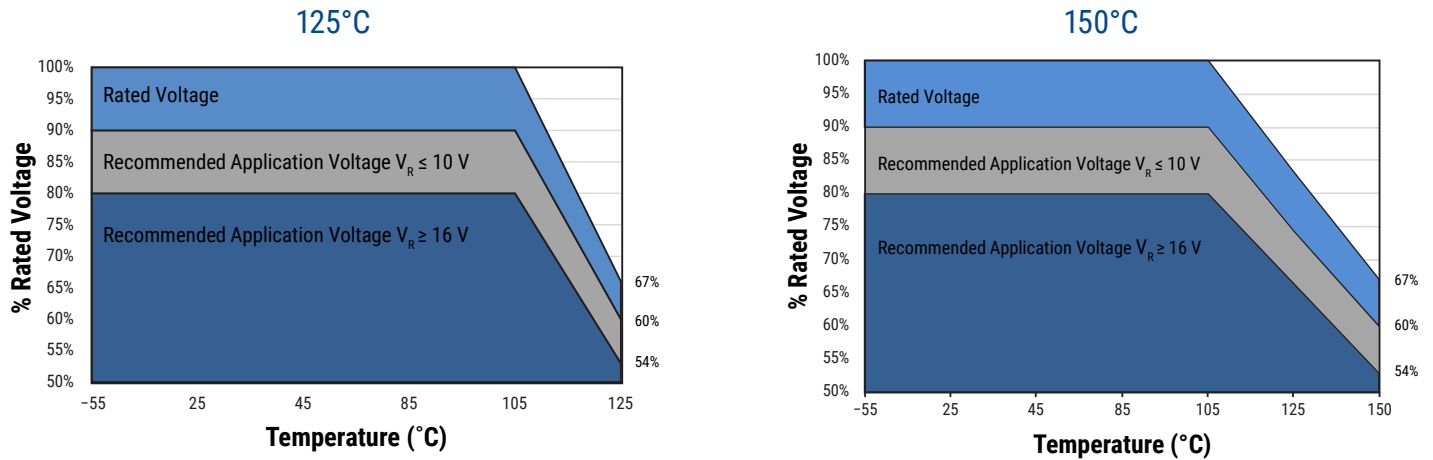

Recommended Application Voltage

KO-CAPs are solid state capacitors that demonstrate no wearout mechanism when operated within their recommended guidelines. While the KO-CAP can be operated at full rated voltage, most circuit designers seek a minimum level of assurance in long term reliability, which should be demonstrated with data. A voltage derating can provide the desired level of demonstrated reliability based on industry accepted acceleration models. Since most applications do require long term reliability, KEMET recommends that designers consider a voltage derating, according the graph above, for the maximum steady state voltage.

Voltage Rating	Maximum Recommended Steady State Voltage		
	-55°C to 105°C	105°C to 125°C (T598)	105°C to 150°C (T599)
$2.5 \text{ V} \leq V_R \leq 10 \text{ V}$	90% of V_R	60% of V_R	60% of V_R
$V_R \geq 16 \text{ V}$	80% of V_R	54% of V_R	54% of V_R

V_R = Rated voltage

Ripple Current/Ripple Voltage

Permissible AC ripple voltage and current are related to equivalent series resistance (ESR) and the power dissipation capabilities of the device. Permissible AC ripple voltage which may be applied is limited by two criteria:

1. The positive peak AC voltage plus the DC bias voltage, if any, must not exceed the DC voltage rating of the capacitor.
2. The negative peak AC voltage in combination with bias voltage, if any, must not exceed the allowable limits specified for reverse voltage. See the Reverse Voltage section for allowable limits.

The maximum power dissipation by case size can be determined using the table at right. The maximum power dissipation rating stated in the table must be reduced with increasing environmental operating temperatures. Refer to the table below for temperature compensation requirements.

Case Code	EIA Case Code	Maximum Power Dissipation (Pmax) mWatts at 45°C with +30°C Rise
B	3528-21	127
D	7343-31	225
P	2012-10	25
S	3216-12	60
V	7343-20	187
X	7343-43	247

Using the Pmax of the device, the maximum allowable rms ripple current or voltage may be determined.

$$I(max) = \sqrt{Pmax/R}$$

$$E(max) = Z \sqrt{Pmax/R}$$

- I* = rms ripple current (amperes)
- E* = rms ripple voltage (volts)
- Pmax* = maximum power dissipation (watts)
- R* = ESR at specified frequency (ohms)
- Z* = Impedance at specified frequency (ohms)

Temperature Compensation Multipliers for Maximum Ripple Current				
T ≤ 45°C	45°C < T ≤ 85°C	85°C < T ≤ 105°C	T ≤ 125°C	T ≤ 150°C
1.00	0.70	0.25	0.25	0.20

T = Environmental temperature

The maximum power dissipation rating must be reduced with increasing environmental operating temperatures. Refer to the Temperature Compensation Multiplier table for details.

Surge Voltage

Surge voltage is the maximum voltage (peak value) which may be applied to the capacitor. The surge voltage must not be applied for periodic charging and discharging in course of normal operation and cannot be part of the application voltage. Surge voltage capability is demonstrated by application of 1,000 cycles at operating temperature. The parts are charged through a 33 Ohm resistor for 30 seconds and then discharged through a 33 Ohm resistor for each cycle.

Rated Voltage (V)	Surge Voltage (V)	Category Voltage (V)	Category Surge Voltage (V)	Category Voltage (V)	Category Surge Voltage (V)
-55°C to 105°C		up to 125°C		up to 150°C*	
2.5	3.3	1.7	2.2	1.7	2.2
6.3	8.2	4.2	5.5	4.2	5.5
10	13	6.7	8.7	6.7	8.7
16	20.8	10.7	13.9	10.7	13.9
20	26	13.4	17.4	13.4	17.4
25	32.5	16.8	21.8	16.8	21.8
35	45.5	23.5	30.5	23.5	30.5
50	65	33.5	43.6	33.5	43.6

*T599 Only

Reverse Voltage

Polymer electrolytic capacitors are polar devices and may be permanently damaged or destroyed if connected in the wrong polarity. These devices will withstand a small degree of transient voltage reversal for short periods as shown in the below table.

Temperature	Permissible Transient Reverse Voltage
25°C	15% of rated voltage
55°C	10% of rated voltage
85°C	5% of rated voltage
105°C	3% of rated voltage
125°C*	1% of rated voltage
150°C**	1% of rated voltage

*For series rated to 125°C

** For series rated to 150°C

Table 2 – Land Dimensions/Courtyard

T591 / T598 / T599

KEMET	Metric Size Code	Density Level A: Maximum (Most) Land Protrusion (mm)					Density Level B: Median (Nominal) Land Protrusion (mm)					Density Level C: Minimum (Least) Land Protrusion (mm)				
		Case	EIA	W	L	S	V1	V2	W	L	S	V1	V2	W	L	S
B	3528-21	2.35	2.21	0.92	6.32	4.00	2.23	1.80	1.12	5.22	3.50	2.13	1.42	1.28	4.36	3.24
D	7343-31	2.55	2.77	3.67	10.22	5.60	2.43	2.37	3.87	9.12	5.10	2.33	1.99	4.03	8.26	4.84
V	7343-21	2.55	2.77	3.67	10.22	5.60	2.43	2.37	3.87	9.12	5.10	2.33	1.99	4.03	8.26	4.84
X ¹	7343-43	2.55	2.77	3.67	10.22	5.60	2.43	2.37	3.87	9.12	5.10	2.33	1.99	4.03	8.26	4.84

Density Level A: For low-density product applications. Recommended for wave solder applications and provides a wider process window for reflow solder processes.

Density Level B: For products with a moderate level of component density. Provides a robust solder attachment condition for reflow solder processes.

Density Level C: For high component density product applications. Before adapting the minimum land pattern variations the user should perform qualification testing based on the conditions outlined in IPC standard 7351 (IPC-7351).

¹ Height of these chips may create problems in wave soldering.

² Land pattern geometry is too small for silkscreen outline.

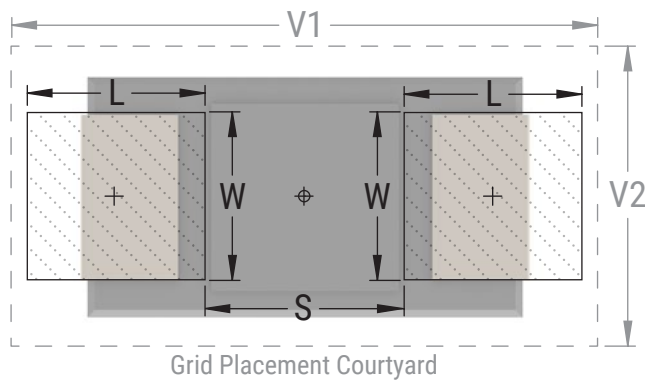

T597

KEMET	Metric Size Code	Dimensions (mm) Minimum – Maximum				
		Case	EIA	G	Z	X
I	3216-10	1.00 – 1.65	3.25 – 3.80	1.1 – 1.30	0.8 – 1.40	
S	3216-12	1.00 – 1.65	3.25 – 3.80	1.1 – 1.30	0.8 – 1.40	
P	2012-10	0.40 – 1.05	2.05 – 2.60	0.80 – 1.00	0.5 – 1.1	

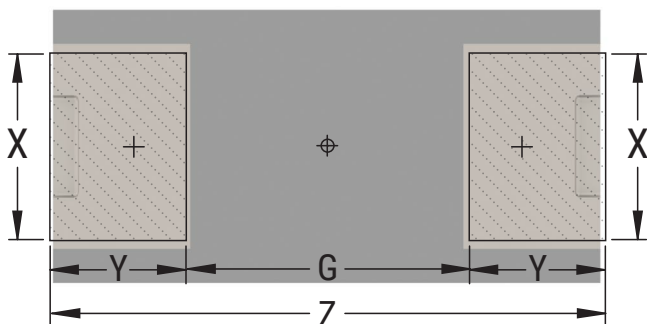

Soldering Process

KEMET's families of surface mount capacitors are compatible with wave (single or dual), convection, IR, or vapor phase reflow techniques. Preheating of these components is recommended to avoid extreme thermal stress. KEMET's recommended profile conditions for convection and IR reflow reflect the profile conditions of the IPC/J-STD-020D standard for moisture sensitivity testing. The devices can safely withstand a maximum of three reflow passes at these conditions.

Please note that although the X/7343-43 case size can withstand wave soldering, the tall profile (4.3 mm maximum) dictates care in wave process development.

Hand soldering should be performed with care due to the difficulty in process control. If performed, care should be taken to avoid contact of the soldering iron to the molded case. The iron should be used to heat the solder pad, applying solder between the pad and the termination, until reflow occurs. Once reflow occurs, the iron should be removed immediately. "Wiping" the edges of a chip and heating the top surface is not recommended.

Profile Feature	SnPb Assembly	Pb-Free Assembly
Preheat/Soak		
Temperature Minimum (T_{smin})	100°C	150°C
Temperature Maximum (T_{smax})	150°C	200°C
Time (t_s) from T_{smin} to T_{smax}	60 – 120 seconds	60 – 120 seconds
Ramp-up Rate (T_L to T_P)	3°C/second maximum	3°C/second maximum
Liquidous Temperature (T_L)	183°C	217°C
Time Above Liquidous (t_L)	60 – 150 seconds	60 – 150 seconds
Peak Temperature (T_P)	220°C* 235°C**	250°C* 260°C**
Time within 5°C of Maximum Peak Temperature (t_p)	20 seconds maximum	30 seconds maximum
Ramp-down Rate (T_P to T_L)	6°C/second maximum	6°C/second maximum
Time 25°C to Peak Temperature	6 minutes maximum	8 minutes maximum

Note: All temperatures refer to the center of the package, measured on the package body surface that is facing up during assembly reflow.

* For Case Size height > 2.5 mm

** For Case Size height ≤ 2.5 mm

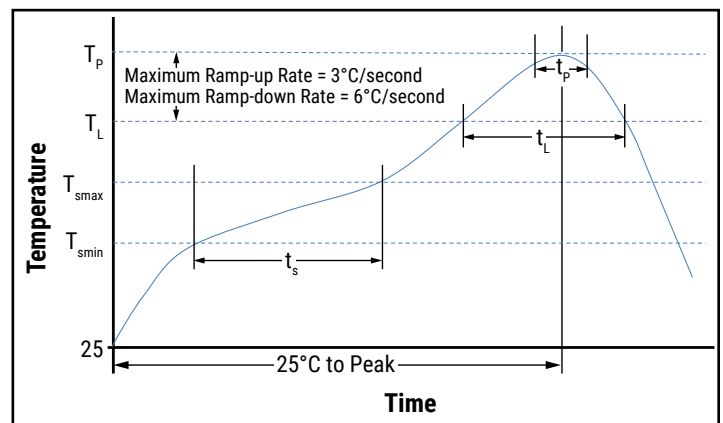

Storage

All KO-CAP capacitors are shipped in moisture barrier bags (MBBs) with desiccant and humidity indicator card (HIC). These parts are classified as moisture sensitivity level 3 (MSL3) per IPC/JEDEC J-STD-020 and packaged per IPC/JEDEC J-STD-033, MSL3 specifies a floor time of 168 H at 30°C maximum temperature and 60% relative humidity. Unused capacitors should be sealed in a MBB with fresh desiccant.

Calculated shelf life in sealed bag:

- 12 months from bag seal date in a storage environment of < 40°C and humidity < 90% RH
- 24 months from bag seal date in a storage environment of < 30°C and humidity < 70% RH

If baking is required, refer to IPC/JEDEC J-STD-033 for bake procedure.

Construction

T591 / T598 / T599

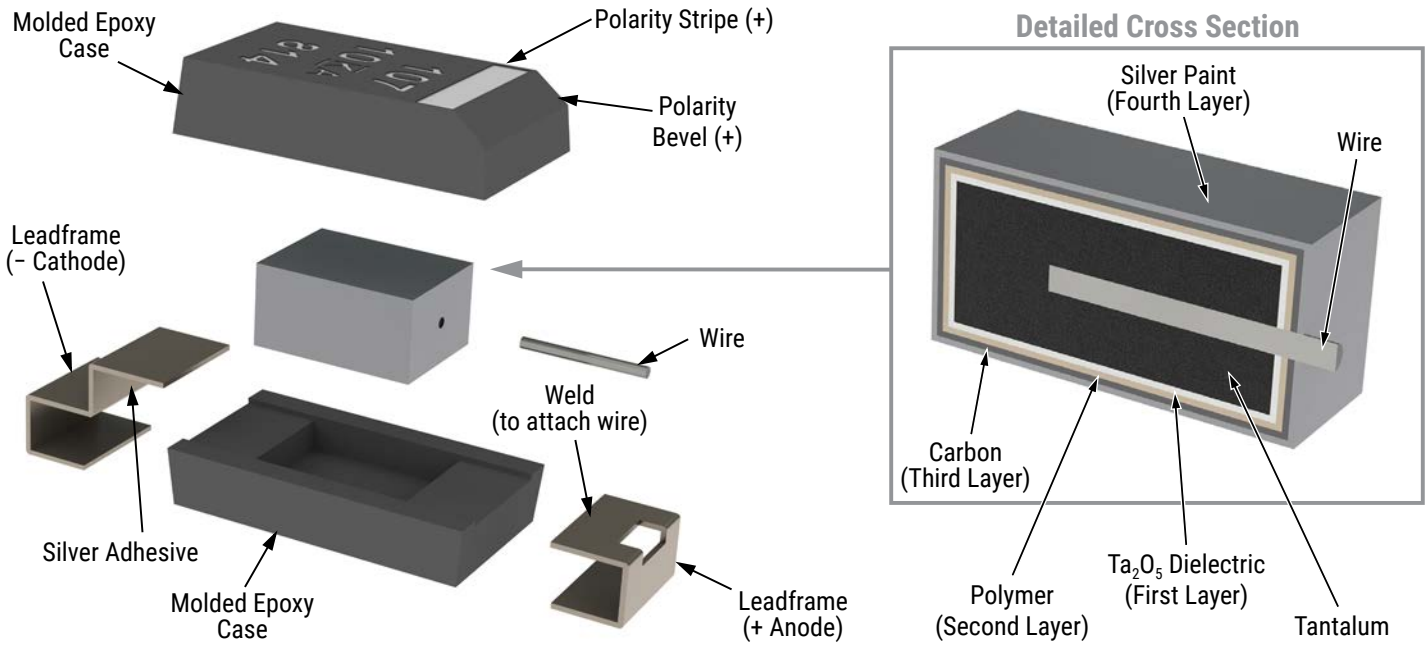

T597

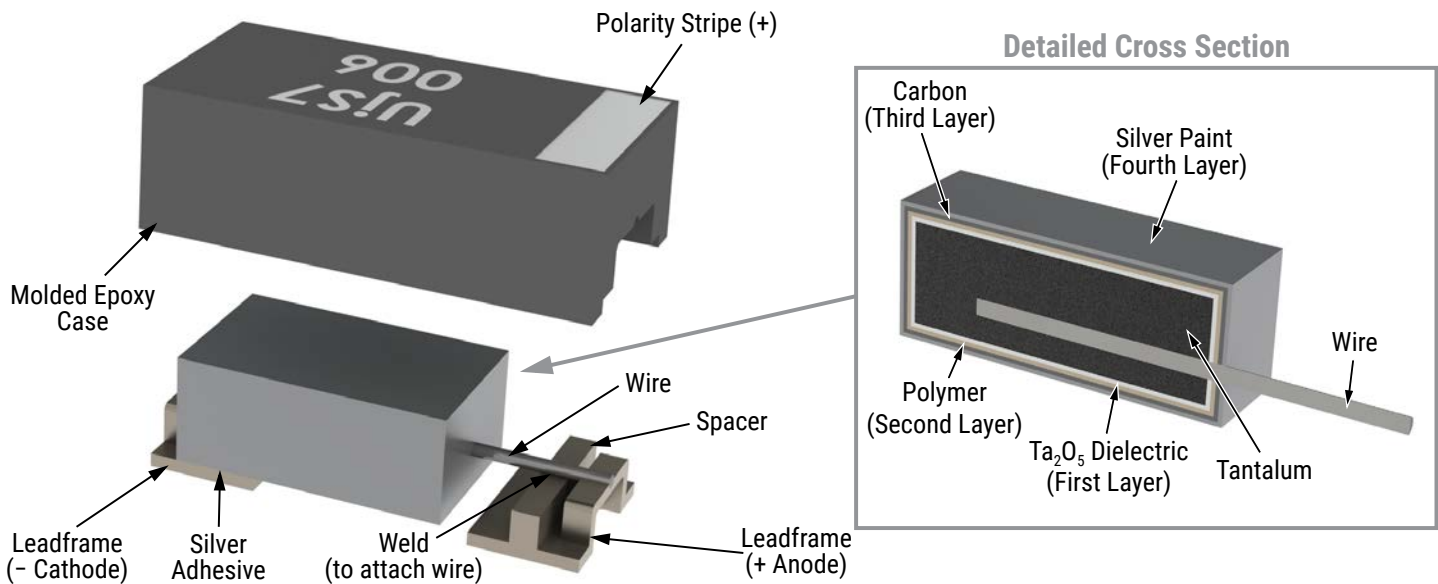

Capacitor Marking

T591/ T598 / T599

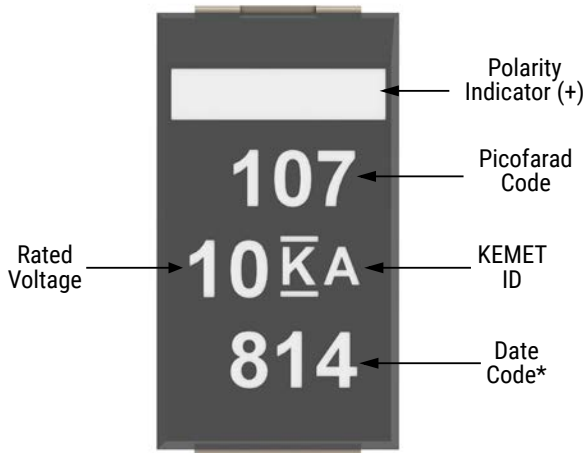

* 822 = 14th week of 2018

Date Code *	
1 st digit = Last number of year	6 = 2016 7 = 2017 8 = 2018 9 = 2019 0 = 2020
2 nd and 3 rd digit = Week of the year	01 = 1 st week of the year to 52 = 52 nd week of the year

T597

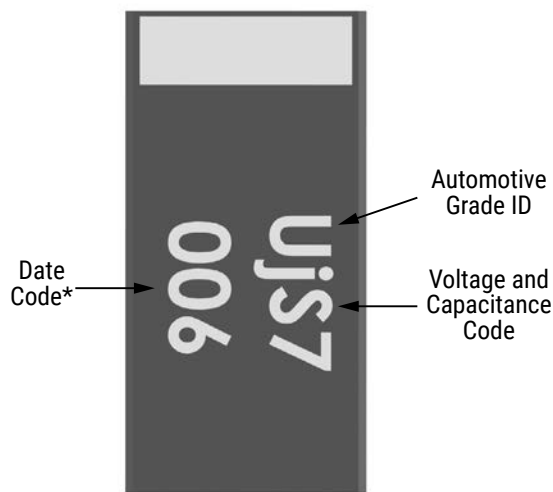

* 008 = 6th week of 2020

Voltage Code		
e	j	A
2.5 V	6.3 V	10 V

Capacitance Code			
J7	N7	S7	A8
22	33	47	100

Date Code *	
1 st digit = Last number of year	8 = 2018 9 = 2019 0 = 2020
2 nd and 3 rd digit = Week of the year	01 = 1 st week of the year to 52 = 52 nd week of the year

Tape & Reel Packaging Information

KEMET’s molded chip capacitor families are packaged in 8 and 12 mm plastic tape on 7" and 13" reels in accordance with *EIA Standard 481: Embossed Carrier Taping of Surface Mount Components for Automatic Handling*. This packaging system is compatible with all tape-fed automatic pick-and-place systems.

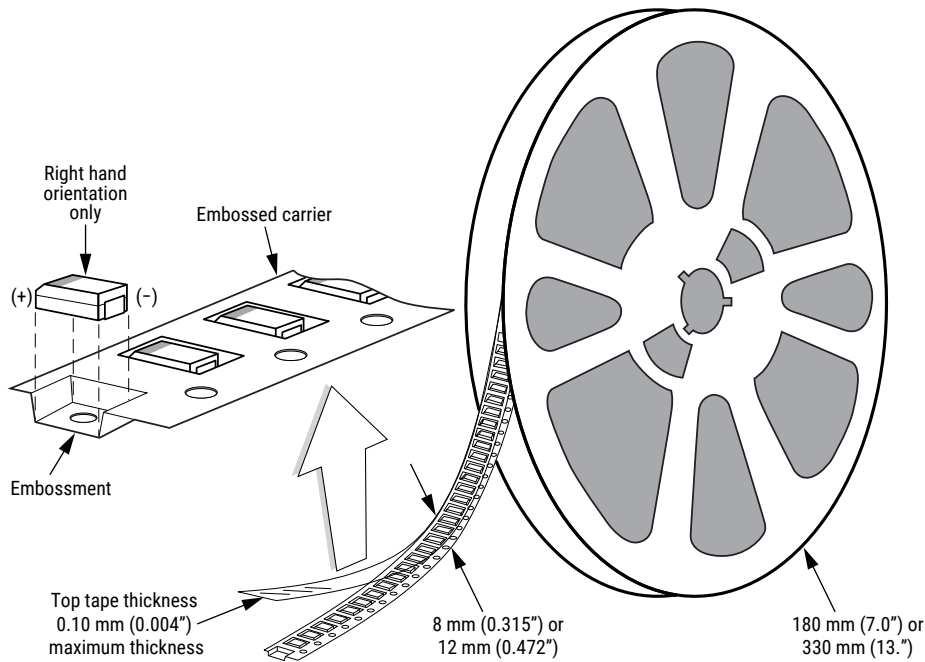

Table 3 – Packaging Quantity

Case Code		Tape Width (mm)	7" Reel*	13" Reel*
KEMET	EIA			
P	2012-10	8	3,000	N/A
R	2012-12	8	2,500	10,000
I	3216-10	8	3,000	N/A
S	3216-12	8	3,000	N/A
A	3216-18	8	2,000	N/A
T	3528-12	8	3,000	10,000
M	3528-15	8	2,500	8,000
B	3528-21	8	2,000	8,000
U	6032-15	12	1,000	5,000
L	6032-19	12	1,000	3,000
C	6032-28	12	500	3,000
Q	7343-12	12	1,000	3,000
W	7343-15	12	1,000	3,000
Z	7343-17	12	1,000	3,000
V	7343-19	12	1,000	3,000
D	7343-31	12	500	2,500
Y	7343-40	12	500	2,000
X	7343-43	12	500	2,000
J	7360-15	12	1,000	3,000
H	7360-20	12	1,000	3,000
O	7360-43	12	250	1,000

* No C-Spec required for 7" reel packaging. C-7280 required for 13" reel packaging.

Figure 1 – Embossed (Plastic) Carrier Tape Dimensions

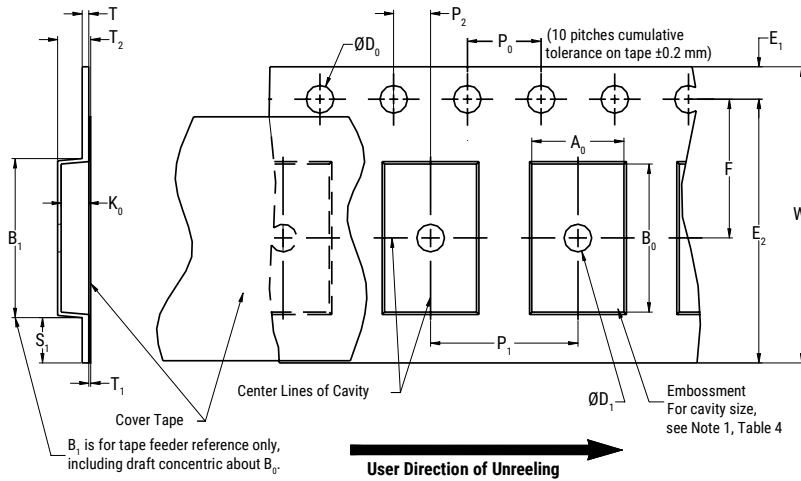

Table 4 – Embossed (Plastic) Carrier Tape Dimensions

Metric will govern

Constant Dimensions – Millimeters (Inches)									
Tape Size	D ₀	D ₁ Minimum Note 1	E ₁	P ₀	P ₂	R Reference Note 2	S ₁ Minimum Note 3	T Maximum	T ₁ Maximum
8 mm	1.5 +0.10/-0.0 (0.059 +0.004/-0.0)	1.0 (0.039)	1.75 ±0.10 (0.069 ±0.004)	4.0 ±0.10 (0.157 ±0.004)	2.0 ±0.05 (0.079 ±0.002)	25.0 (0.984)	0.600 (0.024)	0.600 (0.024)	0.100 (0.004)
12 mm		1.5 (0.059)							

Variable Dimensions – Millimeters (Inches)									
Tape Size	Pitch	B ₁ Maximum Note 4	E ₂ Minimum	F	P ₁	T ₂ Maximum	W Maximum	A ₀ , B ₀ & K ₀	
8 mm	Single (4 mm)	4.35 (0.171)	6.25 (0.246)	3.5 ±0.05 (0.138 ±0.002)	2.0 ±0.05 or 4.0 ±0.10 (0.079 ±0.002 or 0.157 ±0.004)	2.5 (0.098)	8.3 (0.327)	Note 5	
12 mm	Single (4 mm) and Double (8 mm)	8.2 (0.323)	10.25 (0.404)	5.5 ±0.05 (0.217 ±0.002)	2.0 ±0.05 (0.079 ±0.002) or 4.0 ±0.10 (0.157 ±0.004) or 8.0 ±0.10 (0.315 ±0.004)	4.6 (0.181)	12.3 (0.484)		

1. The embossment hole location shall be measured from the sprocket hole controlling the location of the embossment. Dimensions of embossment location and hole location shall be applied independent of each other.
2. The tape, with or without components, shall pass around R without damage (see Figure 4).
3. If S₁ < 1.0 mm, there may not be enough area for cover tape to be properly applied (see EIA Standard 481-D, paragraph 4.3, section b).
4. B₁ dimension is a reference dimension for tape feeder clearance only.
5. The cavity defined by A₀, B₀ and K₀ shall surround the component with sufficient clearance that:
 - (a) the component does not protrude above the top surface of the carrier tape.
 - (b) the component can be removed from the cavity in a vertical direction without mechanical restriction, after the top cover tape has been removed.
 - (c) rotation of the component is limited to 20° maximum for 8 and 12 mm tapes (see Figure 2).
 - (d) lateral movement of the component is restricted to 0.5 mm maximum for 8 mm and 12 mm wide tape (see Figure 3).
 - (e) see Addendum in EIA Standard 481-D for standards relating to more precise taping requirements.

Packaging Information Performance Notes

- 1. Cover tape break force:** 1.0 kg minimum.
- 2. Cover tape peel strength:** The total peel strength of the cover tape from the carrier tape shall be:

Tape Width	Peel Strength
8 mm	0.1 to 1.0 newton (10 to 100 gf)
12 mm	0.1 to 1.3 newton (10 to 130 gf)

The direction of the pull shall be opposite the direction of the carrier tape travel. The pull angle of the carrier tape shall be 165° to 180° from the plane of the carrier tape. During peeling, the carrier and/or cover tape shall be pulled at a velocity of 300 ±10 mm/minute.

- 3. Labeling:** Bar code labeling (standard or custom) shall be on the side of the reel opposite the sprocket holes. Refer to EIA Standards 556 and 624.

Figure 2 – Maximum Component Rotation

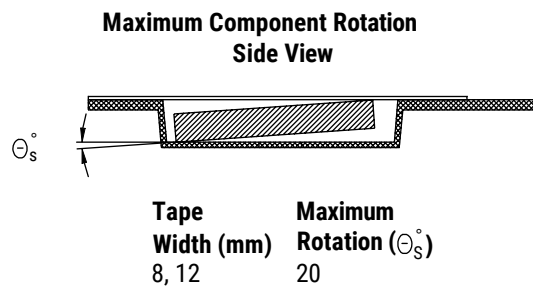
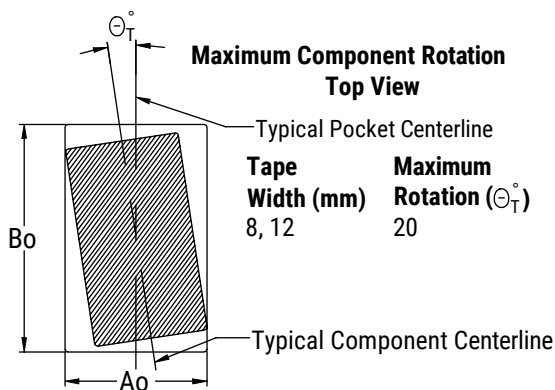

Figure 3 – Maximum Lateral Movement

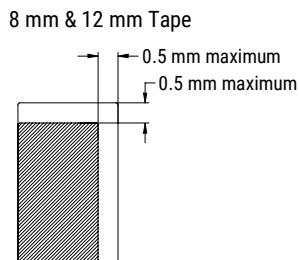

Figure 4 – Bending Radius

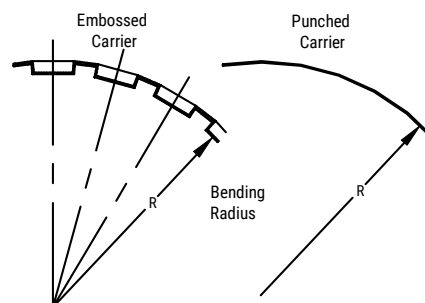
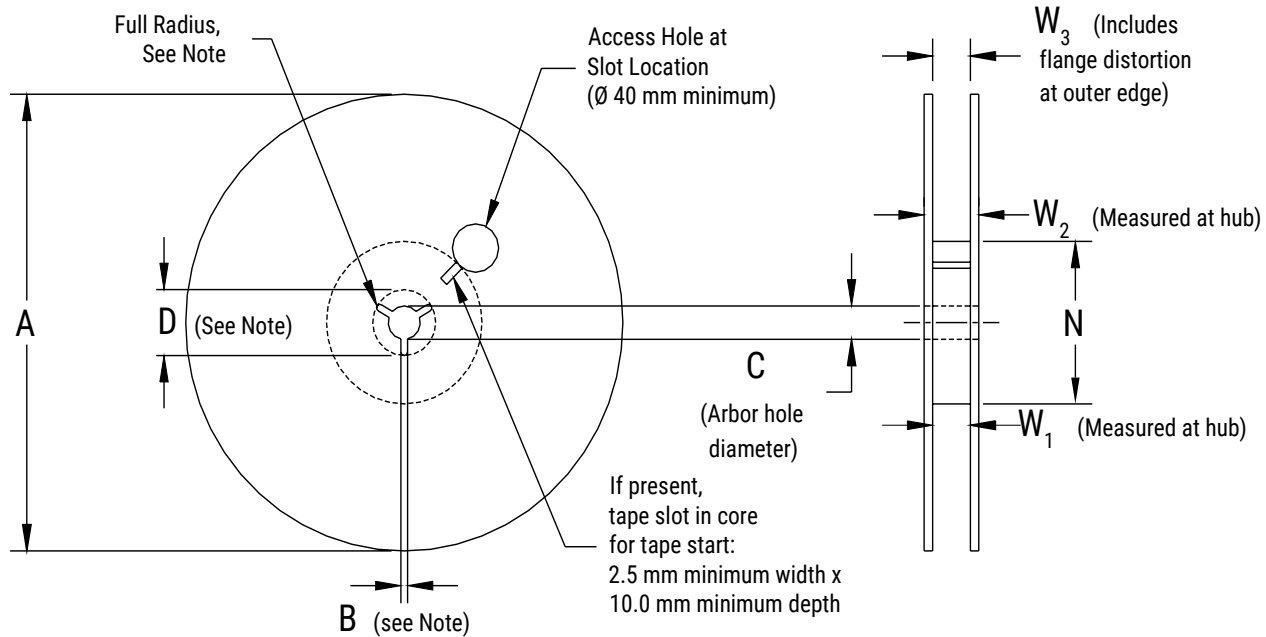

Figure 5 – Reel Dimensions



Note: Drive spokes optional; if used, dimensions B and D shall apply.

Table 5 – Reel Dimensions

Metric will govern

Constant Dimensions – Millimeters (Inches)				
Tape Size	A	B Minimum	C	D Minimum
8 mm	178 ±0.20 (7.008 ±0.008)	1.5 (0.059)	13.0 +0.5/-0.2 (0.521 +0.02/-0.008)	20.2 (0.795)
12 mm	330 ±0.20 (13.000 ±0.008)			
Variable Dimensions – Millimeters (Inches)				
Tape Size	N Minimum	W ₁	W ₂ Maximum	W ₃
8 mm	50 (1.969)	8.4 +1.5/-0.0 (0.331 +0.059/-0.0)	14.4 (0.567)	Shall accommodate tape width without interference
12 mm		12.4 +2.0/-0.0 (0.488 +0.078/-0.0)	18.4 (0.724)	

Figure 6 – Tape Leader & Trailer Dimensions

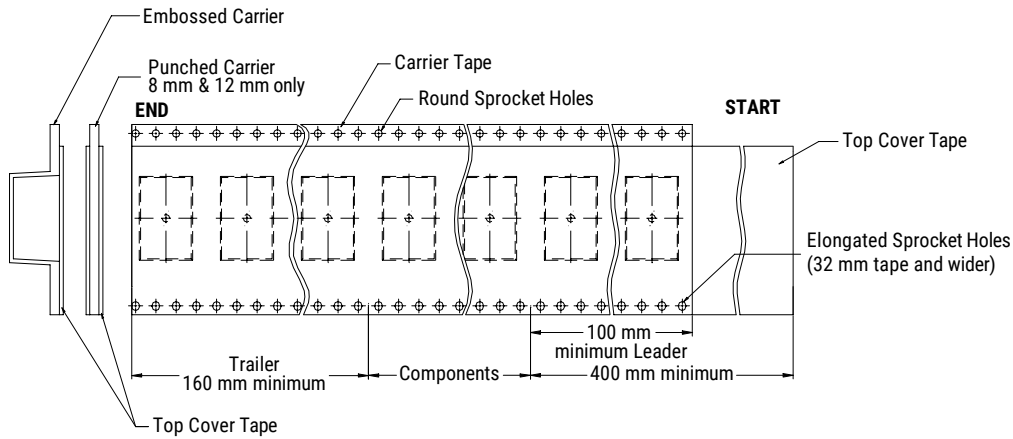
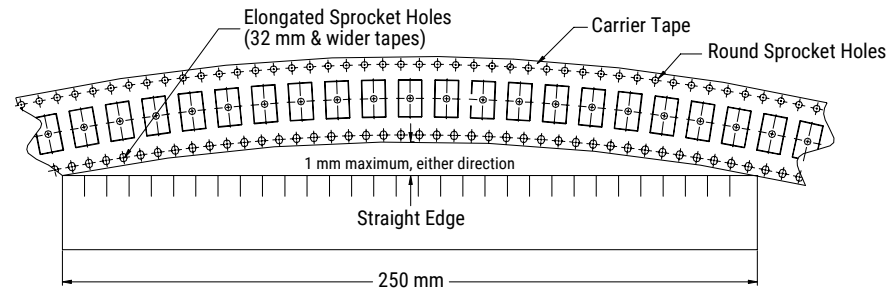

Figure 7 – Maximum Camber



KEMET Electronics Corporation Sales Offices

For a complete list of our global sales offices, please visit www.kemet.com/sales.

Disclaimer

All product specifications, statements, information and data (collectively, the "Information") in this datasheet are subject to change. The customer is responsible for checking and verifying the extent to which the Information contained in this publication is applicable to an order at the time the order is placed. All Information given herein is believed to be accurate and reliable, but it is presented without guarantee, warranty, or responsibility of any kind, expressed or implied.

Statements of suitability for certain applications are based on KEMET Electronics Corporation's ("KEMET") knowledge of typical operating conditions for such applications, but are not intended to constitute – and KEMET specifically disclaims – any warranty concerning suitability for a specific customer application or use. The Information is intended for use only by customers who have the requisite experience and capability to determine the correct products for their application. Any technical advice inferred from this Information or otherwise provided by KEMET with reference to the use of KEMET's products is given gratis, and KEMET assumes no obligation or liability for the advice given or results obtained.

Although KEMET designs and manufactures its products to the most stringent quality and safety standards, given the current state of the art, isolated component failures may still occur. Accordingly, customer applications which require a high degree of reliability or safety should employ suitable designs or other safeguards (such as installation of protective circuitry or redundancies) in order to ensure that the failure of an electrical component does not result in a risk of personal injury or property damage.

Although all product-related warnings, cautions and notes must be observed, the customer should not assume that all safety measures are indicated or that other measures may not be required.

KEMET is a registered trademark of KEMET Electronics Corporation.

Данный компонент на территории Российской Федерации

Вы можете приобрести в компании MosChip.

Для оперативного оформления запроса Вам необходимо перейти по данной ссылке:

<http://moschip.ru/get-element>

Вы можете разместить у нас заказ для любого Вашего проекта, будь то серийное производство или разработка единичного прибора.

В нашем ассортименте представлены ведущие мировые производители активных и пассивных электронных компонентов.

Нашей специализацией является поставка электронной компонентной базы двойного назначения, продукции таких производителей как XILINX, Intel (ex.ALTERA), Vicor, Microchip, Texas Instruments, Analog Devices, Mini-Circuits, Amphenol, Glenair.

Сотрудничество с глобальными дистрибьюторами электронных компонентов, предоставляет возможность заказывать и получать с международных складов практически любой перечень компонентов в оптимальные для Вас сроки.

На всех этапах разработки и производства наши партнеры могут получить квалифицированную поддержку опытных инженеров.

Система менеджмента качества компании отвечает требованиям в соответствии с ГОСТ Р ИСО 9001, ГОСТ РВ 0015-002 и ЭС РД 009

Офис по работе с юридическими лицами:

105318, г.Москва, ул.Щербаковская д.3, офис 1107, 1118, ДЦ «Щербаковский»

Телефон: +7 495 668-12-70 (многоканальный)

Факс: +7 495 668-12-70 (доб.304)

E-mail: info@moschip.ru

Skype отдела продаж:

moschip.ru

moschip.ru_4

moschip.ru_6

moschip.ru_9