

T591, T598, T597, and T599 High Humidity and High Temperature Automotive Grade Polymer Electrolytic, 2.5 – 50 VDC

Overview

KO-CAP Polymer Capacitors

The KEMET Organic Capacitor (KO-CAP) is a solid electrolytic capacitor with a conductive polymer cathode, capable of delivering very low ESR and an improved capacitance retention at high frequencies. KO-CAP combines the low ESR of the multilayer ceramic, the high capacitance of aluminum electrolytic and the volumetric efficiency of tantalum into a single surface mount package. Unlike liquid electrolyte-based capacitors, KO-CAP has a very long operational life and a high ripple current capabilities.

The T591/T597/T598/T599 High Humidity and High Temperature Polymer Electrolytic capacitors deliver higher capacitance and ESR stability under harsh environmental conditions. Enhancements to the design and selected material upgrades were introduced to deliver 500 hours (T591) or 1,000 hours (T598, T599) at 85°C/85% RH rated voltage and to fully comply with the AEC-Q200 qualification testing with maximum operational temperature life up to 125°C and 150°C respectively. These capacitors are manufactured in an ISO TS 16949 certified plants and are subjected to PPAP/PSW, as well as change control.

Benefits

- Ultra low ESR
- Full compliance with AEC-Q200 qualification test plan (T597 FD 125°C, T598 125°C, T599 150°C)
- Qualification plan based on AEC-Q200 with 85°C/85% RH load specification limited to 500 hours (T591)
- Extended endurance test qualification for T598/T599 ($V_R < 16\text{ V}$), up to 2,000 hours 125°C
- TS 16949 certified plants
- Subject to PPAP/PSW and change control
- Meets or exceeds EIA standard 535BAAC
- Tape & Reel standard packaging per EIA 481
- Halogen-free epoxy and RoHS compliant

Applications

Typical applications include decoupling and filtering in a variety of market segments, with special emphasis in automotive applications such as infotainment, ADAS, chassis and safety, as well as powertrain, where harsh conditions, such as high humidity and temperature, are a concern.

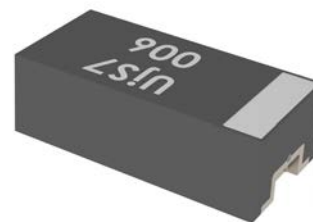
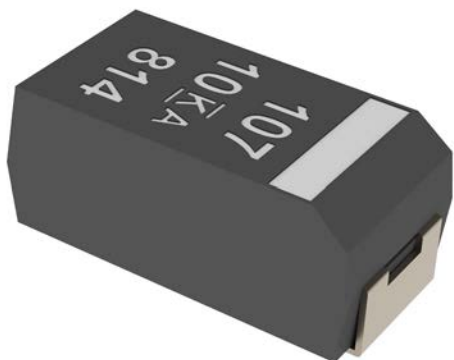

K-SIM

For a detailed analysis of specific part numbers, please visit ksim.kemet.com to access KEMET's K-SIM software. KEMET K-SIM is designed to simulate behavior of components with respect to frequency, ambient temperature, and DC bias levels.

Ordering Information

Standard Construction

| T | 59X | D | 107 | M | 010 | A | T | E025 | |
|-----------------|---|------------------|--|-----------------------|--|---------------------|--------------------|-----------------------------------|------------------------------------|
| Capacitor Class | Series | Case Size | Capacitance Code (pF) | Capacitance Tolerance | Rated Voltage (VDC) | Failure Rate/Design | Termination Finish | ESR | Packaging (C-Spec) |
| T = Tantalum | 591 = 500 Hours load humidity 598 = AEC-Q200 qualified (125°C) 599 = AEC-Q200 qualified (150°C) | B D V X | First two digits represent significant figures. Third digit specifies number of zeros. | M = ±20% K = ±10% | 2R5 = 2.5 006 = 6.3 010 = 10 016 = 16 020 = 20 025 = 25 035 = 35 050 = 50 | A = N/A | T = 100% Tin (Sn) | Maximum ESR in mΩ, 025 = 25 mΩ | Blank = 7" Reel 7280 = 13" Reel |

Face Down Construction

| T | 597 | S | 476 | M | 006 | A | P | E200 | |
|-----------------|---|-----------|--|-----------------------|------------------------------------|---------------------|--------------------|------------------------------------|--------------------|
| Capacitor Class | Series | Case Size | Capacitance Code (pF) | Capacitance Tolerance | Rated Voltage (VDC) | Failure Rate/Design | Termination Finish | ESR | Packaging (C-Spec) |
| T = Tantalum | 597 = AEC-Q200 qualified (125°C) face down construction | P S | First two digits represent significant figures. Third digit specifies number of zeros. | M = ±20% | 2R5 = 2.5 006 = 6.3 010 = 10 | A = N/A | P = Ni-Pd-Au | Maximum ESR in mΩ, 200 = 200 mΩ | Blank = 7" Reel |

Performance Characteristics

| Item | Performance Characteristics |
|-------------------------|--|
| Operating Temperature | -55°C to 105°C/125°C/150°C |
| Rated Capacitance Range | 10 – 470 μF at 120 Hz/25°C |
| Capacitance Tolerance | K Tolerance (10%), M Tolerance (20%) |
| Rated Voltage Range | 2.5 – 50 V |
| DF (120 Hz) | Refer to Part Number Electrical Specification Table |
| ESR (100 kHz) | Refer to Part Number Electrical Specification Table |
| Leakage Current | ≤ 0.1 CV (μA) at rated voltage after 5 minutes T597: ≤ 0.3 CV (μA) at rated voltage after 5 minutes |

Environmental Compliance

RoHS compliant (6/6) according to Directive 2002/95/EC when ordered with 100% Sn solder. Halogen-free.

Qualification

| Test | Condition | Characteristics | | | | |
|-----------------------------------|--|-----------------|-----------------------------------|-------|----------|------------------------------------|
| Endurance | 105°C at rated voltage, 2,000 hours 125°C at 2/3 rated voltage, 2,000 hours* ² 150°C at 2/3 rated voltage, 1,000 hours (T599, $V_R > 16$ V) 150°C at 2/3 rated voltage, 2,000 hours (T599, $V_R < 16$ V) | Δ C/C | Within -20%/+10% of initial value | | | |
| | | DF | Within 2 x initial limit | | | |
| | | DCL | Within 2 x initial limit | | | |
| | | ESR | Within 2 x initial limit | | | |
| Storage Life | 105°C at 0 volts, 2,000 hours 125°C at 0 volts, 1,000 hours* ² 150°C at 0 volts, 1,000 hours (T599) | Δ C/C | Within -20%/+10% of initial value | | | |
| | | DF | Within 2 x initial limit | | | |
| | | DCL | Within 2 x initial limit | | | |
| | | ESR | Within 2 x initial limit | | | |
| Humidity | 85°C, 85% RH, load, 500 hours (T591) 85°C, 85% RH, load, 1,000 hours (T597, T598, T599) | Δ C/C | Within -5%/+35% of initial value | | | |
| | | DF | Within 1.5 x initial limits | | | |
| | | DCL | Within initial limit | | | |
| | | ESR | Within 2 x initial limit | | | |
| Moisture Resistance* ¹ | MIL-STD-202, Method 106, 65°C, 90 – 100% RH, no load, 10 cycles | Δ C/C | Within -10%/+20% of initial value | | | |
| | | DF | Within initial limit | | | |
| | | DCL | Within initial limit | | | |
| | | ESR | Within 2 x initial limit | | | |
| Temperature Cycling | JESD22, Test Method A104, -55°C to +105°C/+125°C/+150°C* ² , 1,000 cycles | Δ C/C | Within -20%/+10% of initial value | | | |
| | | DF | Within initial limits | | | |
| | | DCL | Within initial limit | | | |
| | | ESR | Within 2 x initial limits | | | |
| Surge Voltage | 105°C, 1.32 x rated voltage, 1,000 cycles, 33 Ω in series 125°C/150°C, 1.32 x (0.67 x V_R), 1,000 cycles, 33 Ω in series* ² | Δ C/C | Within -20%/+10% of initial value | | | |
| | | DF | Within initial limits | | | |
| | | DCL | Within initial limits | | | |
| | | ESR | Within initial limits | | | |
| Temperature Stability | Extreme temperature exposure at a succession of continuous steps at +25°C, -55°C, +25°C, +85°C, +105°C/+125°C/+150°C* ² , +25°C | Δ C/C | +25°C | -55°C | +85°C | +105°C/+125°C/+150°C* ² |
| | | DF | IL* ³ | ±20% | ±20% | ±30%* ⁴ |
| | | DCL | IL | IL | 1.2 x IL | 1.5 x IL |
| Mechanical Shock/Vibration | AEC-Q200 (MIL-STD-202, Method 213, Figure 1, Condition F.) | Δ C/C | Within ±10% of initial value | | | |
| | | DF | Within initial limits | | | |
| | AEC-Q200 (MIL-STD-202, Method 204, 5 G for 20 minutes/12 cycles each of 3 orientations. Test from 10 – 2,000 Hz.) | ESR | Within initial limits | | | |
| | | DCL | Within initial limits | | | |

*¹ T598 only

*² Refer to part number specifications for individual temperature classification

*³ IL = Initial limit

*⁴ For T599 (≤ 16 V) apply -30%/+40%

Reliability

KO-CAP capacitors have an average failure rate of 0.5 %/1,000 hours at category voltage, U_c , and category temperature, T_c . These capacitors are qualified using industry test standards at U_c and T_c . The minimum test time (1,000 hours or 2,000 hours) is dependent on the product.

The actual life expectancy of KO-CAP capacitors increases when application voltage, U_A , and application temperature, T_A , are lower than U_c and T_c . As a general guideline, when $U_A < 0.9 * U_c$ and $T_A < 85^\circ\text{C}$, the life expectancy will typically exceed the useful lifetime of most hardware (> 10 years).

The lifetime of a KO-CAP capacitor at a specific application voltage and temperature can be modeled using the equations below. A failure is defined as passing enough current to blow a 1-amp fuse. The calculation is an estimation based on empirical results and is not a guarantee.

$$VAF = \left(\frac{U_c}{U_A}\right)^n$$

where:
 VAF = acceleration factor due to voltage, unitless
 U_c = category voltage, volt
 U_A = application voltage, volt
 n = exponent, 16

$$TAF = e^{\left[\frac{E_a}{k} \left(\frac{1}{273+T_A} - \frac{1}{273+T_c}\right)\right]}$$

where:
 TAF = acceleration factor due to temperature, unitless
 E_a = activation energy, 1.4 eV
 k = Boltzmann's constant, 8.617E-5 eV/K
 T_A = application temperature, °C
 T_c = category temperature, °C

$$AF = VAF * TAF$$

where:
 AF = acceleration factor, unitless
 TAF = acceleration factor due to temperature, unitless
 VAF = acceleration factor due to voltage, unitless

$$Life_{U_A, T_A} = Life_{U_c, T_c} * AF$$

where:
 $Life_{U_A, T_A}$ = guaranteed life application voltage and temperature, years
 $Life_{U_c, T_c}$ = guaranteed life category voltage and temperature, years
 AF = acceleration factor, unitless

| Reliability Table 1 – Common Temperature Range Classifications | | | | | | | | | | | | | | |
|--|----------------------------|-----|-----|-----|-----|------|------|------|------|------|------|------|------|------|
| 85°C (T_R)/ 85°C (T_c) | Rated voltage (U_R) | 2.5 | 4.0 | 6.3 | 8.0 | 10.0 | 12.5 | 16.0 | 20.0 | 25.0 | 35.0 | 50.0 | 63.0 | 75.0 |
| | Category voltage (U_c) | 2.5 | 4.0 | 6.3 | 8.0 | 10.0 | 12.5 | 16.0 | 20.0 | 25.0 | 35.0 | 50.0 | 63.0 | 75.0 |
| 105°C (T_R)/ 105°C (T_c) | Rated voltage (U_R) | 2.5 | 4.0 | 6.3 | 8.0 | 10.0 | 12.5 | 16.0 | 20.0 | 25.0 | 35.0 | 50.0 | 63.0 | 75.0 |
| | Category voltage (U_c) | 2.5 | 4.0 | 6.3 | 8.0 | 10.0 | 12.5 | 16.0 | 20.0 | 25.0 | 35.0 | 50.0 | 63.0 | 75.0 |
| 105°C (T_R)/ 125°C (T_c) | Rated voltage (U_R) | 2.5 | 4.0 | 6.3 | 8.0 | 10.0 | 12.5 | 16.0 | 20.0 | 25.0 | 35.0 | 50.0 | 63.0 | 75.0 |
| | Category voltage (U_c) | 1.7 | 2.7 | 4.2 | 5.4 | 6.7 | 8.4 | 10.7 | 13.4 | 16.8 | 23.5 | 33.5 | 42.2 | 50.3 |
| 105°C (T_R)/ 150°C (T_c) | Rated voltage (U_R) | 2.5 | 4.0 | 6.3 | 8.0 | 10.0 | 12.5 | 16.0 | 20.0 | 25.0 | 35.0 | 50.0 | 63.0 | 75.0 |
| | Category voltage (U_c) | 1.7 | 2.7 | 4.2 | 5.4 | 6.7 | 8.4 | 10.7 | 13.4 | 16.8 | 23.5 | 33.5 | 42.2 | 50.3 |

Terms:

Category voltage, U_c : Maximum recommended peak DC operating voltage for continuous operation at the category temperature, T_c .
 Rated voltage, U_R : Maximum recommended peak DC operating voltage for continuous operation up to the rated temperature, T_R .
 Category temperature, T_c : Maximum recommended operating temperature. Voltage derating may be required at T_c .
 Rated temperature, T_R : Maximum recommended operating temperature without voltage derating. T_R is equal to or lower than T_c .

Certification

KEMET's internal qualification plan for this polymer electrolytic series of capacitors follows AEC-Q200 guidelines.

For T591 the humidity bias is limited to a maximum of 500 hours.

For T597 and T598 the qualification plan is fully compliant with AEC-Q200 with maximum operational temperature of 125°C.

For T599 the qualification plan is fully compliant with AEC-Q200 with maximum operational temperature of 150°C.

Electrical Characteristics

ESR vs. Frequency – T591

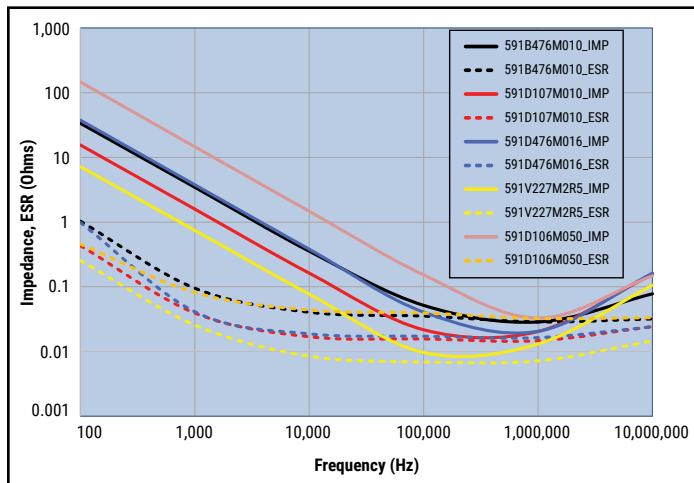

Capacitance vs. Frequency – T591

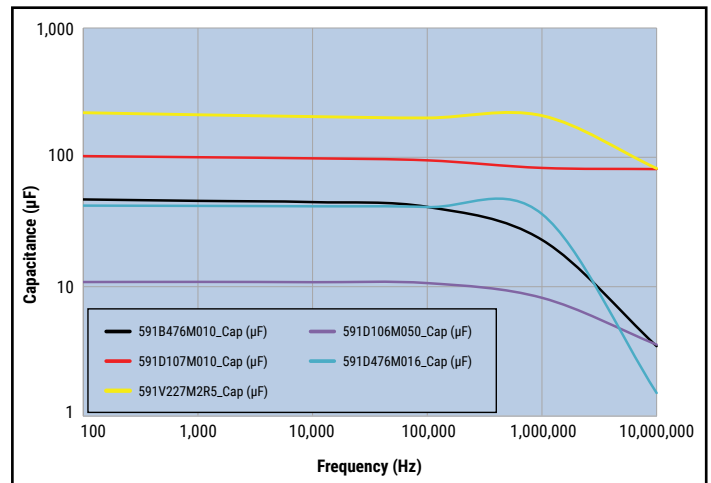

ESR vs. Frequency – T597

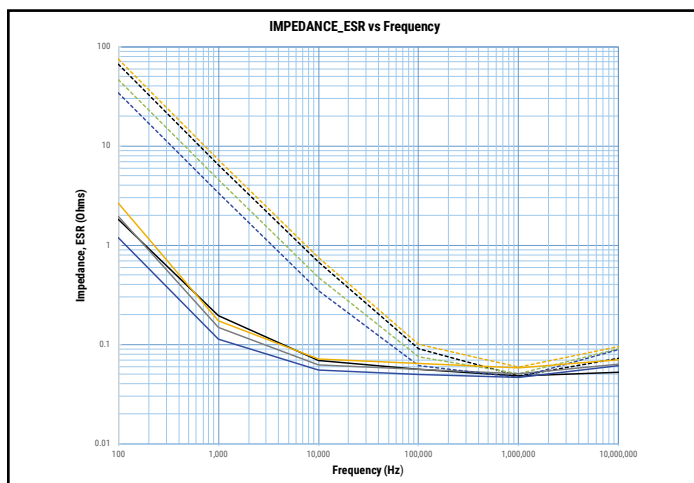

Capacitance vs. Frequency – T597

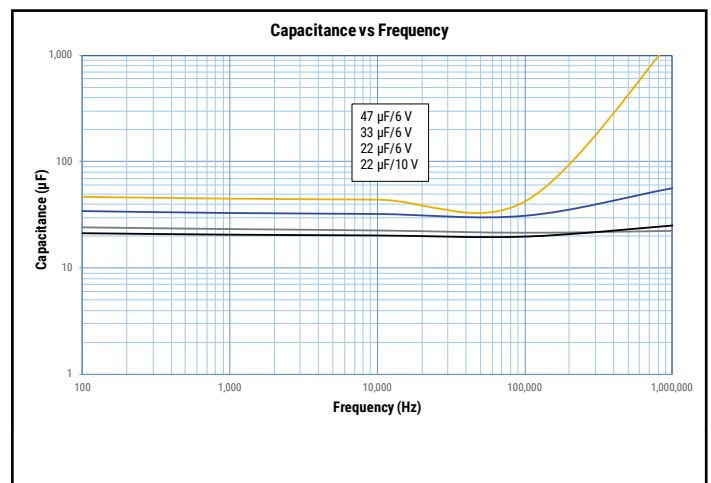

Electrical Characteristics cont.

ESR vs. Frequency – T598

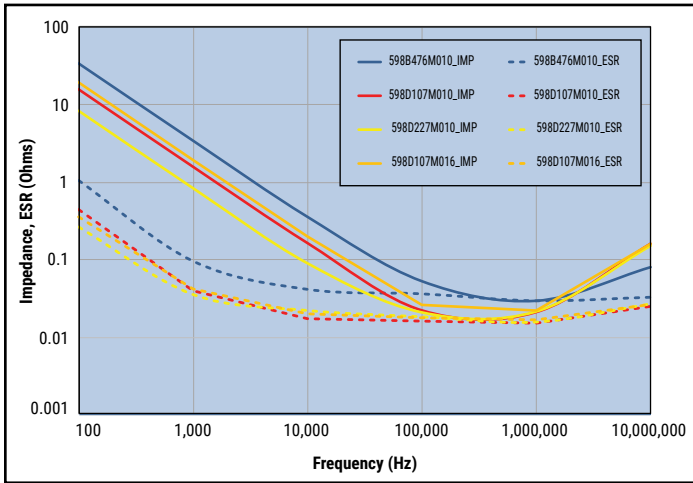

Capacitance vs. Frequency – T598

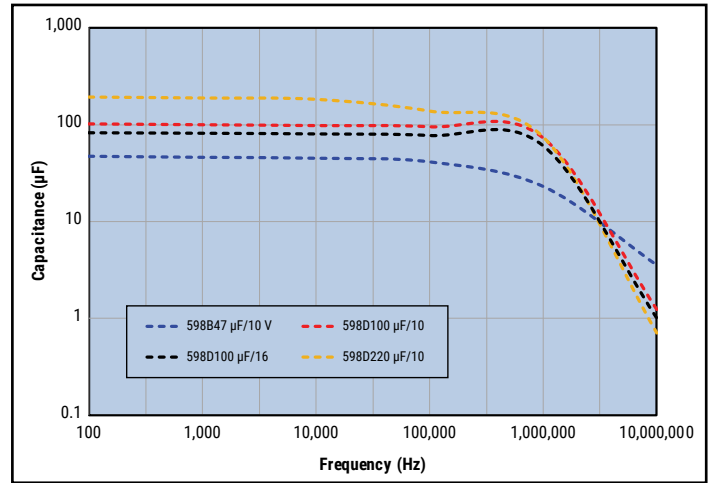

ESR vs. Frequency – T599

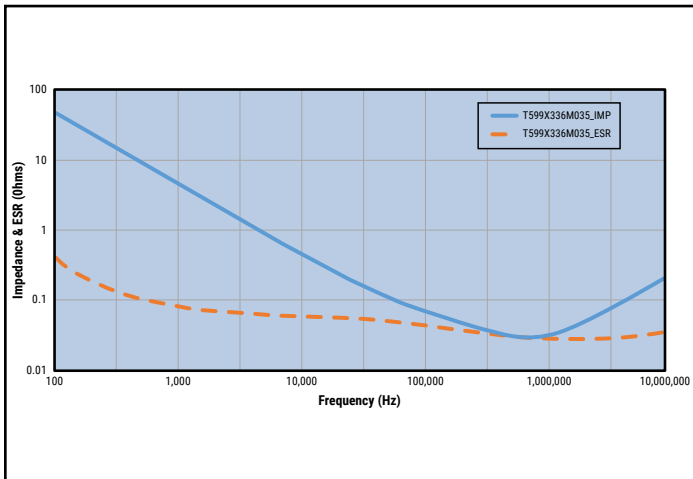

Capacitance vs. Frequency – T599

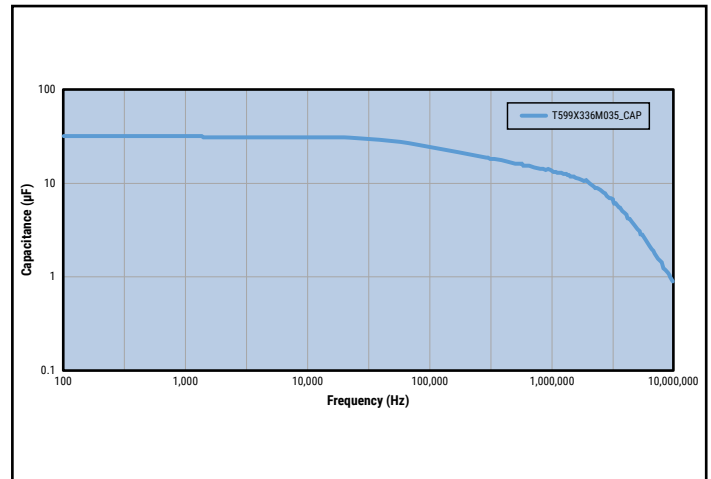

Dimensions – Millimeters (Inches)

Metric will govern

T591 / T598 / T599

CATHODE (-) END VIEW

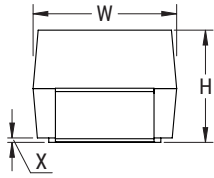

SIDE VIEW

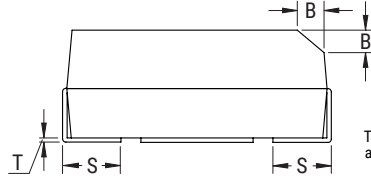

ANODE (+) END VIEW

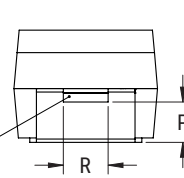

BOTTOM VIEW

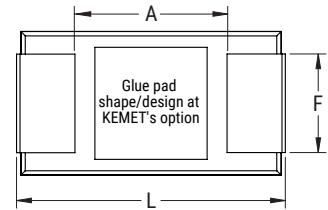

Termination cutout at KEMET's option, either end

| Case Size | | Component Dimensions | | | | | | | | | | | Typical Weight |
|-----------|---------|----------------------------|----------------------------|----------------------------|--------------------|--------------------|-------------------------|------------------------------|----------------|----------------|-----------------|----------------|----------------|
| KEMET | EIA | L | W | H | F ±0.1 ±(0.004) | S ±0.3 ±(0.012) | B ±0.15 (Ref) ±0.006 | X (Ref) | P (Ref) | R (Ref) | T (Ref) | A (Minimum) | (mg) |
| B | 3528-21 | 3.5 ±0.2 (0.138 ±0.008) | 2.8 ±0.2 (0.110 ±0.008) | 1.9 ±0.2 (0.075 ±0.008) | 2.2 (0.087) | 0.8 (0.031) | 0.4 (0.016) | 0.10 ±0.10 (0.004 ±0.004) | 0.5 (0.020) | 1.0 (0.039) | 0.13 (0.005) | 1.1 (0.043) | 95 |
| D | 7343-31 | 7.3 ±0.3 (0.287 ±0.012) | 4.3 ±0.3 (0.169 ±0.012) | 2.8 ±0.3 (0.110 ±0.012) | 2.4 (0.094) | 1.3 (0.051) | 0.5 (0.020) | 0.10 ±0.10 (0.004 ±0.004) | 0.9 (0.035) | 1.0 (0.039) | 0.13 (0.005) | 3.8 (0.150) | 435 |
| V | 7343-20 | 7.3 ±0.3 (0.287 ±0.012) | 4.3 ±0.3 (0.169 ±0.012) | 1.9 ±0.1 (0.075 ±0.004) | 2.4 (0.094) | 1.3 (0.051) | N/A | 0.05 (0.002) | N/A | N/A | 0.13 (0.005) | 3.8 (0.150) | 274 |
| X | 7343-43 | 7.3 ±0.3 (0.287 ±0.012) | 4.3 ±0.3 (0.169 ±0.012) | 4.0 ±0.3 (0.157 ±0.012) | 2.4 (0.094) | 1.3 (0.051) | 0.5 (0.020) | 0.10 ±0.10 (0.004 ±0.004) | 1.7 (0.067) | 1.0 (0.039) | 0.13 (0.005) | 3.8 (0.150) | 554 |

Notes: Reference (Ref) – Dimensions provided for reference only. For low profile cases, no dimensions are provided for B, P, or R, because these cases do not have a bevel or a notch.

These weights are provided as reference. If exact weights are needed, please contact your KEMET sales representative.

T597

END VIEW

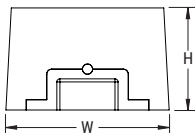

SIDE VIEW

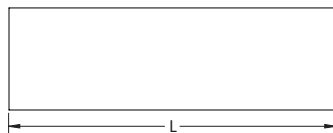

BOTTOM VIEW

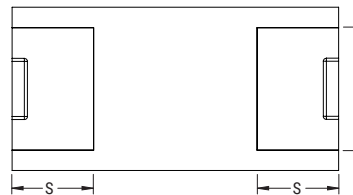

| Case Size | | Component Dimensions | | | | | Weight |
|-----------|---------|----------------------------|----------------------------|----------------------------|-----------------|-----------------|--------|
| KEMET | EIA | L | W | H | F ±0.1 (±0.004) | S ±0.2 (±0.008) | (mg) |
| P | 2012-10 | 2.0 ±0.2 (0.079 ±0.008) | 1.2 ±0.2 (0.047 ±0.008) | 0.9 ±0.1 (0.035 ±0.004) | 0.9 (0.035) | 0.55 (0.022) | 11.3 |
| S | 3216-12 | 3.2 ±0.2 (0.126 ±0.008) | 1.6 ±0.2 (0.063 ±0.008) | 1.1 ±0.1 (0.043 ±0.004) | 1.2 (0.047) | 0.8 (0.031) | 26.2 |

Table 1 – Ratings & Part Number Reference

| Rated Voltage | Rated Cap | Case Code/ Case Size | KEMET Part Number | DC Leakage | DF | ESR | Maximum Allowable Ripple Current | MSL | Maximum Operating Temp | AEC-Q200 Qualified |
|---------------|-----------|-------------------------|--------------------|---------------------------|-----------------------|-------------------------|----------------------------------|---------------------|------------------------|-----------------------------|
| VDC at 105°C | µF | KEMET/EIA | | µA at +25°C Max/5 Minutes | % at +25°C 120 Hz Max | mΩ at +25°C 100 kHz Max | (rms) mA at +45°C 100 kHz | Reflow Temp ≤ 260°C | °C | T598/T599 Only ¹ |
| 105°C | | | | | | | | | | |
| 2.5 | 100 | B/3528-21 | T591B107M2R5ATE055 | 25 | 8 | 55 | 1,520 | 3 | 105 | |
| 2.5 | 100 | B/3528-21 | T591B107M2R5ATE070 | 25 | 8 | 70 | 1,347 | 3 | 105 | |
| 2.5 | 220 | B/3528-21 | T591B227M2R5ATE025 | 55 | 8 | 25 | 2,260 | 3 | 105 | |
| 2.5 | 220 | V/7343-20 | T591V227M2R5ATE009 | 55 | 10 | 9 | 4,558 | 3 | 105 | |
| 2.5 | 220 | V/7343-20 | T591V227M2R5ATE012 | 55 | 10 | 12 | 3,947 | 3 | 105 | |
| 2.5 | 220 | V/7343-20 | T591V227M2R5ATE015 | 55 | 10 | 15 | 3,531 | 3 | 105 | |
| 2.5 | 470 | D/7343-31 | T591D477M2R5ATE009 | 117.5 | 10 | 9 | 5,000 | 3 | 105 | |
| 4 | 100 | B/3528-21 | T591B107M004ATE070 | 40 | 10 | 70 | 1,347 | 3 | 105 | |
| 4 | 220 | V/7343-20 | T591V227M004ATE018 | 88 | 10 | 18 | 3,223 | 3 | 105 | |
| 4 | 220 | V/7343-20 | T591V227M004ATE025 | 88 | 10 | 25 | 2,735 | 3 | 105 | |
| 6.3 | 220 | B/3528-21 | T591B227M006ATE035 | 139 | 8 | 35 | 1,900 | 3 | 105 | |
| 125°C | | | | | | | | | | |
| 2.5 | 100 | B/3528-21 | T598B107M2R5ATE055 | 25 | 8 | 55 | 1,520 | 3 | 125 | • |
| 2.5 | 100 | B/3528-21 | T598B107M2R5ATE070 | 25 | 8 | 70 | 1,347 | 3 | 125 | • |
| 2.5 | 330 | V/7343-20 | T591V337M2R5ATE012 | 82.5 | 10 | 12 | 3,947 | 3 | 125 | |
| 2.5 | 330 | V/7343-20 | T591V337M2R5ATE025 | 82.5 | 10 | 25 | 2,735 | 3 | 125 | |
| 2.5 | 330 | D/7343-31 | T591D337M2R5ATE015 | 82.5 | 10 | 15 | 3,873 | 3 | 125 | |
| 2.5 | 330 | D/7343-31 | T591D337M2R5ATE018 | 82.5 | 10 | 18 | 3,536 | 3 | 125 | |
| 2.5 | 470 | D/7343-31 | T598D477M2R5ATE009 | 117.5 | 10 | 9 | 5,000 | 3 | 125 | • |
| 4 | 100 | B/3528-21 | T598B107M004ATE045 | 40 | 10 | 45 | 1,680 | 3 | 125 | • |
| 4 | 100 | B/3528-21 | T598B107M004ATE055 | 40 | 10 | 55 | 1,520 | 3 | 125 | • |
| 4 | 100 | B/3528-21 | T598B107M004ATE070 | 40 | 10 | 70 | 1,347 | 3 | 125 | • |
| 4 | 100 | B/3528-21 | T591B107M004ATE045 | 40 | 8 | 45 | 1,680 | 3 | 125 | |
| 4 | 100 | B/3528-21 | T591B107M004ATE055 | 40 | 8 | 55 | 1,520 | 3 | 125 | |
| 4 | 150 | B/3528-21 | T598B157M004ATE045 | 60 | 8 | 45 | 1,680 | 3 | 125 | • |
| 4 | 150 | B/3528-21 | T598B157M004ATE055 | 60 | 8 | 55 | 1,520 | 3 | 125 | • |
| 4 | 150 | B/3528-21 | T598B157M004ATE070 | 60 | 8 | 70 | 1,347 | 3 | 125 | • |
| 4 | 150 | B/3528-21 | T591B157M004ATE045 | 60 | 8 | 45 | 1,680 | 3 | 125 | |
| 4 | 150 | B/3528-21 | T591B157M004ATE055 | 60 | 8 | 55 | 1,520 | 3 | 125 | |
| 4 | 150 | B/3528-21 | T591B157M004ATE070 | 60 | 8 | 70 | 1,347 | 3 | 125 | |
| 4 | 330 | V/7343-20 | T598V337M004ATE025 | 132 | 10 | 25 | 2,735 | 3 | 125 | • |
| 4 | 330 | V/7343-20 | T598V337M004ATE045 | 132 | 10 | 45 | 2,039 | 3 | 125 | • |
| 4 | 330 | V/7343-20 | T591V337M004ATE025 | 132 | 10 | 25 | 2,735 | 3 | 125 | |
| 4 | 330 | V/7343-20 | T591V337M004ATE045 | 132 | 10 | 45 | 2,039 | 3 | 125 | |
| 6.3 | 33 | B/3528-21 | T598B336M006ATE070 | 20.8 | 8 | 70 | 1,347 | 3 | 125 | • |
| 6.3 | 33 | B/3528-21 | T598B336M006ATE080 | 20.8 | 8 | 80 | 1,260 | 3 | 125 | • |
| 6.3 | 33 | B/3528-21 | T591B336M006ATE070 | 20.8 | 8 | 70 | 1,347 | 3 | 125 | |
| 6.3 | 33 | B/3528-21 | T591B336M006ATE080 | 20.8 | 8 | 80 | 1,260 | 3 | 125 | |
| 6.3 | 47 | B/3528-21 | T598B476M006ATE070 | 29.6 | 8 | 70 | 1,347 | 3 | 125 | • |
| 6.3 | 47 | B/3528-21 | T591B476M006ATE070 | 29.6 | 8 | 70 | 1,347 | 3 | 125 | |
| 6.3 | 68 | B/3528-21 | T598B686M006ATE070 | 43 | 8 | 70 | 1,347 | 3 | 125 | • |
| 6.3 | 68 | B/3528-21 | T591B686M006ATE070 | 43 | 8 | 70 | 1,347 | 3 | 125 | |
| 6.3 | 100 | B/3528-21 | T598B107M006ATE045 | 63 | 8 | 45 | 1,680 | 3 | 125 | • |
| 6.3 | 100 | B/3528-21 | T598B107M006ATE055 | 63 | 8 | 55 | 1,520 | 3 | 125 | • |
| 6.3 | 100 | B/3528-21 | T598B107M006ATE070 | 63 | 8 | 70 | 1,347 | 3 | 125 | • |
| 6.3 | 100 | B/3528-21 | T591B107M006ATE045 | 63 | 8 | 45 | 1,680 | 3 | 125 | |
| 6.3 | 100 | B/3528-21 | T591B107M006ATE055 | 63 | 8 | 55 | 1,520 | 3 | 125 | |
| 6.3 | 100 | B/3528-21 | T591B107M006ATE070 | 63 | 8 | 70 | 1,347 | 3 | 125 | |
| 6.3 | 150 | B/3528-21 | T598B157M006ATE045 | 94.5 | 8 | 45 | 1,680 | 3 | 125 | • |
| VDC at 105°C | µF | KEMET/EIA | | µA at +25°C Max/5 Minutes | % at +25°C 120 Hz Max | mΩ at +25°C 100 kHz Max | mA at +45°C 100 kHz | Reflow Temp ≤ 260°C | °C | T598/T599 Only ¹ |
| Rated Voltage | Rated Cap | Case Code/ Case Size | KEMET Part Number | DC Leakage | DF | ESR | Maximum Allowable Ripple Current | MSL | Maximum Operating Temp | AEC-Q200 Qualified |

(1) To complete KEMET part number, insert M for ±20% or K for ±10%. Designates capacitance tolerance.

¹ T598 = AEC-Q200 qualified. T599 AEC-Q200 qualified 150°C and T591 = limited to 500 hours at 85°C/85% RH load.

Refer to Ordering Information for additional detail.

Table 1 – Ratings & Part Number Reference cont.

| Rated Voltage | Rated Cap | Case Code/ Case Size | KEMET Part Number | DC Leakage | DF | ESR | Maximum Allowable Ripple Current | MSL | Maximum Operating Temp | AEC-Q200 Qualified |
|---------------|-----------|-------------------------|--------------------|------------------------------|--------------------------|----------------------------|-------------------------------------|------------------------|------------------------------|--------------------------------|
| VDC at 105°C | µF | KEMET/EIA | | µA at +25°C Max/5 Minutes | % at +25°C 120 Hz Max | mΩ at +25°C 100 kHz Max | (rms) mA at +45°C 100 kHz | Reflow Temp ≤ 260°C | °C | T598/T599 Only ¹ |
| 125°C | | | | | | | | | | |
| 6.3 | 150 | B/3528-21 | T598B157M006ATE055 | 94.5 | 8 | 55 | 1,520 | 3 | 125 | • |
| 6.3 | 150 | B/3528-21 | T598B157M006ATE070 | 94.5 | 8 | 70 | 1,347 | 3 | 125 | • |
| 6.3 | 150 | B/3528-21 | T591B157M006ATE045 | 94.5 | 8 | 45 | 1,680 | 3 | 125 | |
| 6.3 | 150 | B/3528-21 | T591B157M006ATE055 | 94.5 | 8 | 55 | 1,520 | 3 | 125 | |
| 6.3 | 150 | B/3528-21 | T591B157M006ATE070 | 94.5 | 8 | 70 | 1,347 | 3 | 125 | |
| 6.3 | 150 | V/7343-20 | T598V157M006ATE025 | 94.5 | 10 | 25 | 2,735 | 3 | 125 | • |
| 6.3 | 150 | V/7343-20 | T598V157M006ATE045 | 94.5 | 10 | 45 | 2,039 | 3 | 125 | • |
| 6.3 | 150 | V/7343-20 | T591V157M006ATE025 | 94.5 | 10 | 25 | 2,735 | 3 | 125 | |
| 6.3 | 150 | V/7343-20 | T591V157M006ATE045 | 94.5 | 10 | 45 | 2,039 | 3 | 125 | |
| 6.3 | 150 | D/7343-31 | T598D157M006ATE025 | 94.5 | 10 | 25 | 3,000 | 3 | 125 | • |
| 6.3 | 150 | D/7343-31 | T598D157M006ATE045 | 94.5 | 10 | 45 | 2,236 | 3 | 125 | • |
| 6.3 | 150 | D/7343-31 | T591D157M006ATE025 | 94.5 | 10 | 25 | 3,000 | 3 | 125 | |
| 6.3 | 150 | D/7343-31 | T591D157M006ATE045 | 94.5 | 10 | 45 | 2,236 | 3 | 125 | |
| 6.3 | 220 | B/3528-21 | T591B227M006ATE045 | 139 | 8 | 45 | 1,680 | 3 | 125 | |
| 6.3 | 220 | B/3528-21 | T591B227M006ATE070 | 139 | 8 | 70 | 1,347 | 3 | 125 | |
| 6.3 | 220 | D/7343-31 | T598D227M006ATE025 | 139 | 10 | 25 | 3,000 | 3 | 125 | • |
| 6.3 | 220 | D/7343-31 | T598D227M006ATE040 | 139 | 10 | 40 | 2,372 | 3 | 125 | • |
| 6.3 | 220 | D/7343-31 | T598D227M006ATE080 | 139 | 10 | 80 | 1,677 | 3 | 125 | • |
| 6.3 | 220 | D/7343-31 | T591D227M006ATE025 | 139 | 10 | 25 | 3,000 | 3 | 125 | |
| 6.3 | 220 | D/7343-31 | T591D227M006ATE040 | 139 | 10 | 40 | 2,372 | 3 | 125 | |
| 6.3 | 220 | D/7343-31 | T591D227M006ATE080 | 139 | 10 | 80 | 1,677 | 3 | 125 | |
| 6.3 | 220 | V/7343-20 | T598V227M006ATE025 | 139 | 10 | 25 | 2,735 | 3 | 125 | • |
| 6.3 | 220 | V/7343-20 | T598V227M006ATE045 | 139 | 10 | 45 | 2,039 | 3 | 125 | • |
| 6.3 | 220 | V/7343-20 | T591V227M006ATE025 | 139 | 10 | 25 | 2,735 | 3 | 125 | |
| 6.3 | 220 | V/7343-20 | T591V227M006ATE045 | 139 | 10 | 45 | 2,039 | 3 | 125 | |
| 6.3 | 330 | D/7343-31 | T598D337M006ATE025 | 208 | 10 | 25 | 3,000 | 3 | 125 | • |
| 6.3 | 330 | D/7343-31 | T598D337M006ATE040 | 208 | 10 | 40 | 2,372 | 3 | 125 | • |
| 6.3 | 330 | D/7343-31 | T598D337M006ATE080 | 208 | 10 | 80 | 1,677 | 3 | 125 | • |
| 6.3 | 330 | D/7343-31 | T591D337M006ATE025 | 208 | 10 | 25 | 3,000 | 3 | 125 | |
| 6.3 | 330 | D/7343-31 | T591D337M006ATE040 | 208 | 10 | 40 | 2,372 | 3 | 125 | |
| 6.3 | 330 | D/7343-31 | T591D337M006ATE080 | 208 | 10 | 80 | 1,677 | 3 | 125 | |
| 10 | 33 | B/3528-21 | T598B336M010ATE070 | 33 | 8 | 70 | 1,347 | 3 | 125 | • |
| 10 | 33 | B/3528-21 | T598B336M010ATE080 | 33 | 8 | 80 | 1,260 | 3 | 125 | • |
| 10 | 33 | B/3528-21 | T591B336M010ATE070 | 33 | 8 | 70 | 1,347 | 3 | 125 | |
| 10 | 33 | B/3528-21 | T591B336M010ATE080 | 33 | 8 | 80 | 1,260 | 3 | 125 | |
| 10 | 47 | B/3528-21 | T598B476M010ATE070 | 47 | 8 | 70 | 1,347 | 3 | 125 | • |
| 10 | 47 | B/3528-21 | T591B476M010ATE070 | 47 | 8 | 70 | 1,347 | 3 | 125 | |
| 10 | 100 | D/7343-31 | T598D107M010ATE025 | 100 | 10 | 25 | 3,000 | 3 | 125 | • |
| 10 | 100 | D/7343-31 | T598D107M010ATE040 | 100 | 10 | 40 | 2,372 | 3 | 125 | • |
| 10 | 100 | D/7343-31 | T598D107M010ATE080 | 100 | 10 | 80 | 1,677 | 3 | 125 | • |
| 10 | 100 | D/7343-31 | T591D107M010ATE025 | 100 | 10 | 25 | 3,000 | 3 | 125 | |
| 10 | 100 | D/7343-31 | T591D107M010ATE040 | 100 | 10 | 40 | 2,372 | 3 | 125 | |
| 10 | 100 | D/7343-31 | T591D107M010ATE080 | 100 | 10 | 80 | 1,677 | 3 | 125 | |
| 10 | 100 | V/7343-20 | T598V107M010ATE025 | 100 | 10 | 25 | 2,735 | 3 | 125 | • |
| 10 | 100 | V/7343-20 | T598V107M010ATE045 | 100 | 10 | 45 | 2,039 | 3 | 125 | • |
| 10 | 100 | V/7343-20 | T591V107M010ATE025 | 100 | 10 | 25 | 2,735 | 3 | 125 | |
| 10 | 100 | V/7343-20 | T591V107M010ATE045 | 100 | 10 | 45 | 2,039 | 3 | 125 | |
| 10 | 150 | D/7343-31 | T598D157M010ATE025 | 150 | 10 | 25 | 3,000 | 3 | 125 | • |
| 10 | 150 | D/7343-31 | T598D157M010ATE045 | 150 | 10 | 45 | 2,236 | 3 | 125 | • |
| VDC at 105°C | µF | KEMET/EIA | | µA at +25°C Max/5 Minutes | % at +25°C 120 Hz Max | mΩ at +25°C 100 kHz Max | mA at +45°C 100 kHz | Reflow Temp ≤ 260°C | °C | T598/T599 Only ¹ |
| Rated Voltage | Rated Cap | Case Code/ Case Size | KEMET Part Number | DC Leakage | DF | ESR | Maximum Allowable Ripple Current | MSL | Maximum Operating Temp | AEC-Q200 Qualified |

(1) To complete KEMET part number, insert M for ±20% or K for ±10%. Designates capacitance tolerance.

¹ T598 = AEC-Q200 qualified. T599 AEC-Q200 qualified 150°C and T591 = limited to 500 hours at 85°C/85% RH load.

Refer to Ordering Information for additional detail.

Table 1 – Ratings & Part Number Reference cont.

| Rated Voltage | Rated Cap | Case Code/ Case Size | KEMET Part Number | DC Leakage | DF | ESR | Maximum Allowable Ripple Current | MSL | Maximum Operating Temp | AEC-Q200 Qualified |
|---------------|-----------|-------------------------|----------------------|------------------------------|--------------------------|----------------------------|-------------------------------------|------------------------|------------------------------|--------------------------------|
| VDC at 105°C | µF | KEMET/EIA | | µA at +25°C Max/5 Minutes | % at +25°C 120 Hz Max | mΩ at +25°C 100 kHz Max | (rms) mA at +45°C 100 kHz | Reflow Temp ≤ 260°C | °C | T598/T599 Only ¹ |
| 125°C | | | | | | | | | | |
| 10 | 150 | D/7343-31 | T591D157M010ATE025 | 150 | 10 | 25 | 3,000 | 3 | 125 | |
| 10 | 150 | D/7343-31 | T591D157M010ATE045 | 150 | 10 | 45 | 2,236 | 3 | 125 | |
| 10 | 150 | V/7343-20 | T598V157M010ATE025 | 150 | 10 | 25 | 2,735 | 3 | 125 | • |
| 10 | 150 | V/7343-20 | T598V157M010ATE045 | 150 | 10 | 45 | 2,236 | 3 | 125 | • |
| 10 | 150 | V/7343-20 | T591V157M010ATE025 | 150 | 10 | 25 | 2,735 | 3 | 125 | |
| 10 | 150 | V/7343-20 | T591V157M010ATE045 | 150 | 10 | 45 | 2,236 | 3 | 125 | |
| 10 | 220 | D/7343-31 | T598D227M010ATE025 | 220 | 10 | 25 | 3,000 | 3 | 125 | • |
| 10 | 220 | D/7343-31 | T598D227M010ATE040 | 220 | 10 | 40 | 2,372 | 3 | 125 | • |
| 10 | 220 | D/7343-31 | T598D227M010ATE080 | 220 | 10 | 80 | 1,677 | 3 | 125 | • |
| 10 | 220 | D/7343-31 | T591D227M010ATE025 | 220 | 10 | 25 | 3,000 | 3 | 125 | |
| 10 | 220 | D/7343-31 | T591D227M010ATE040 | 220 | 10 | 40 | 2,372 | 3 | 125 | |
| 10 | 220 | D/7343-31 | T591D227M010ATE080 | 220 | 10 | 80 | 1,677 | 3 | 125 | |
| 16 | 47 | D/7343-31 | T598D476M016ATE070 | 75.2 | 10 | 70 | 1,793 | 3 | 125 | • |
| 16 | 47 | D/7343-31 | T591D476M016ATE070 | 75.2 | 10 | 70 | 1,793 | 3 | 125 | |
| 16 | 100 | D/7343-31 | T598D107M016ATE050 | 160 | 10 | 50 | 2,121 | 3 | 125 | • |
| 16 | 100 | D/7343-31 | T591D107M016ATE050 | 160 | 10 | 50 | 2,121 | 3 | 125 | |
| 16 | 150 | D/7343-31 | T598D157M016ATE065 | 240 | 10 | 65 | 1,900 | 3 | 125 | • |
| 16 | 150 | D/7343-31 | T591D157M016ATE065 | 240 | 10 | 65 | 1,900 | 3 | 125 | |
| 20 | 47 | D/7343-31 | T591D476M020ATE050 | 94 | 10 | 50 | 2,121 | 3 | 125 | |
| 20 | 68 | D/7343-31 | T591D686M020ATE040 | 136 | 10 | 40 | 2,372 | 3 | 125 | |
| 20 | 68 | D/7343-31 | T591D686M020ATE050 | 136 | 10 | 50 | 2,121 | 3 | 125 | |
| 25 | 22 | D/7343-31 | T591D226M025ATE060 | 55 | 10 | 60 | 1,936 | 3 | 125 | |
| 25 | 33 | D/7343-31 | T598D336M025ATE060 | 82.5 | 10 | 60 | 1,936 | 3 | 125 | • |
| 25 | 33 | D/7343-31 | T591D336M025ATE060 | 82.5 | 10 | 60 | 1,936 | 3 | 125 | |
| 25 | 47 | D/7343-31 | T598D476M025ATE060 | 117.5 | 10 | 60 | 1,936 | 3 | 125 | • |
| 35 | 2.2 | B/3528-21 | T598B225M035ATE150 | 7.7 | 8 | 150 | 920 | 3 | 125 | • |
| 35 | 2.2 | B/3528-21 | T591B225M035ATE150 | 7.7 | 8 | 150 | 920 | 3 | 125 | |
| 35 | 2.2 | B/3528-21 | T598B225M035ATE200 | 7.7 | 8 | 200 | 797 | 3 | 125 | • |
| 35 | 2.2 | B/3528-21 | T591B225M035ATE200 | 7.7 | 8 | 200 | 797 | 3 | 125 | |
| 35 | 3.3 | B/3528-21 | T598B335M035ATE150 | 11.6 | 8 | 150 | 920 | 3 | 125 | • |
| 35 | 3.3 | B/3528-21 | T591B335M035ATE150 | 11.6 | 8 | 150 | 920 | 3 | 125 | |
| 35 | 3.3 | B/3528-21 | T598B335M035ATE200 | 11.6 | 8 | 200 | 797 | 3 | 125 | • |
| 35 | 3.3 | B/3528-21 | T591B335M035ATE200 | 11.6 | 8 | 200 | 797 | 3 | 125 | |
| 35 | 4.7 | B/3528-21 | T598B475M035ATE200 | 16.5 | 8 | 200 | 797 | 3 | 125 | • |
| 35 | 4.7 | B/3528-21 | T591B475M035ATE200 | 16.5 | 8 | 200 | 797 | 3 | 125 | |
| 35 | 10 | D/7343-31 | T598D106M035ATE120 | 35 | 10 | 120 | 1,369 | 3 | 125 | • |
| 35 | 10 | D/7343-31 | T591D106M035ATE120 | 35 | 10 | 120 | 1,369 | 3 | 125 | |
| 35 | 10 | V/7343-20 | T598V106M035ATE120 | 35 | 10 | 120 | 1,248 | 3 | 125 | • |
| 35 | 10 | V/7343-20 | T591V106M035ATE120 | 35 | 10 | 120 | 1,248 | 3 | 125 | |
| 35 | 15 | D/7343-31 | T598D156M035ATE065 | 52.5 | 10 | 65 | 1,900 | 3 | 125 | • |
| 35 | 22 | D/7343-31 | T598D226M035ATE065 | 77 | 10 | 65 | 1,900 | 3 | 125 | • |
| 35 | 33 | D/7343-31 | T598D336M035ATE065 | 115.5 | 10 | 65 | 1,900 | 3 | 125 | • |
| 35 | 33 | D/7343-31 | T591D336M035ATE065 | 115.5 | 10 | 65 | 1,900 | 3 | 125 | |
| 35 | 33 | X/7343-43 | T598X336M035ATE065 | 115.5 | 10 | 65 | 1,949 | 3 | 125 | • |
| 50 | 1.5 | B/3528-21 | T598B155(1)050ATE200 | 7.5 | 8 | 200 | 797 | 3 | 125 | • |
| 50 | 1.5 | B/3528-21 | T591B155(1)050ATE200 | 7.5 | 8 | 200 | 797 | 3 | 125 | |
| 50 | 2.2 | B/3528-21 | T598B225M050ATE150 | 11 | 8 | 150 | 920 | 3 | 125 | • |
| 50 | 2.2 | B/3528-21 | T598B225M050ATE200 | 11 | 8 | 200 | 797 | 3 | 125 | • |
| 50 | 2.2 | B/3528-21 | T591B225M050ATE150 | 11 | 8 | 150 | 920 | 3 | 125 | |
| VDC at 105°C | µF | KEMET/EIA | | µA at +25°C Max/5 Minutes | % at +25°C 120 Hz Max | mΩ at +25°C 100 kHz Max | mA at +45°C 100 kHz | Reflow Temp ≤ 260°C | °C | T598/T599 Only ¹ |
| Rated Voltage | Rated Cap | Case Code/ Case Size | KEMET Part Number | DC Leakage | DF | ESR | Maximum Allowable Ripple Current | MSL | Maximum Operating Temp | AEC-Q200 Qualified |

(1) To complete KEMET part number, insert M for ±20% or K for ±10%. Designates capacitance tolerance.

¹ T598 = AEC-Q200 qualified. T599 AEC-Q200 qualified 150°C and T591 = limited to 500 hours at 85°C/85% RH load.

Refer to Ordering Information for additional detail.

Table 1 – Ratings & Part Number Reference cont.

| Rated Voltage | Rated Cap | Case Code/ Case Size | KEMET Part Number | DC Leakage | DF | ESR | Maximum Allowable Ripple Current | MSL | Maximum Operating Temp | AEC-Q200 Qualified |
|------------------------------|-----------|-------------------------|--------------------|---------------------------|-----------------------|-------------------------|----------------------------------|---------------------|------------------------|-----------------------------|
| VDC at 105°C | µF | KEMET/EIA | | µA at +25°C Max/5 Minutes | % at +25°C 120 Hz Max | mΩ at +25°C 100 kHz Max | (rms) mA at +45°C 100 kHz | Reflow Temp ≤ 260°C | °C | T598/T599 Only ¹ |
| 125°C | | | | | | | | | | |
| 50 | 2.2 | B/3528-21 | T591B225M050ATE200 | 11 | 8 | 200 | 797 | 3 | 125 | |
| 50 | 10 | D/7343-31 | T598D106M050ATE090 | 50 | 10 | 90 | 1,581 | 3 | 125 | • |
| 50 | 10 | D/7343-31 | T591D106M050ATE090 | 50 | 10 | 90 | 1,581 | 3 | 125 | |
| 150°C | | | | | | | | | | |
| 4 | 33 | B/3528-21 | T599B336M004ATE070 | 13.2 | 8 | 70 | 1,347 | 3 | 150 | • |
| 4 | 33 | B/3528-21 | T599B336M004ATE090 | 13.2 | 8 | 90 | 1,188 | 3 | 150 | • |
| 4 | 47 | B/3528-21 | T599B476M004ATE070 | 18.8 | 8 | 70 | 1,347 | 3 | 150 | • |
| 4 | 47 | B/3528-21 | T599B476M004ATE090 | 18.8 | 8 | 90 | 1,188 | 3 | 150 | • |
| 4 | 68 | B/3528-21 | T599B686M004ATE070 | 27.2 | 8 | 70 | 1,347 | 3 | 150 | • |
| 4 | 68 | B/3528-21 | T599B686M004ATE090 | 27.2 | 8 | 90 | 1,188 | 3 | 150 | • |
| 4 | 150 | D/7343-31 | T599D157M004ATE025 | 60 | 10 | 25 | 3,000 | 3 | 150 | • |
| 4 | 150 | D/7343-31 | T599D157M004ATE045 | 60 | 10 | 45 | 2,236 | 3 | 150 | • |
| 6.3 | 33 | B/3528-21 | T599B336M006ATE070 | 20.8 | 8 | 70 | 1,347 | 3 | 150 | • |
| 6.3 | 33 | B/3528-21 | T599B336M006ATE090 | 20.8 | 8 | 90 | 1,188 | 3 | 150 | • |
| 6.3 | 47 | B/3528-21 | T599B476M006ATE070 | 29.6 | 8 | 70 | 1,347 | 3 | 150 | • |
| 6.3 | 47 | B/3528-21 | T599B476M006ATE090 | 29.6 | 8 | 90 | 1,188 | 3 | 150 | • |
| 6.3 | 150 | D/7343-31 | T599D157M006ATE025 | 94.5 | 10 | 25 | 3,000 | 3 | 150 | • |
| 6.3 | 150 | D/7343-31 | T599D157M006ATE045 | 94.5 | 10 | 45 | 2,236 | 3 | 150 | • |
| 10 | 33 | B/3528-21 | T599B336M010ATE070 | 33 | 8 | 70 | 1,347 | 3 | 150 | • |
| 10 | 33 | B/3528-21 | T599B336M010ATE090 | 33 | 8 | 90 | 1,188 | 3 | 150 | • |
| 10 | 33 | B/3528-21 | T599B336M010ATE150 | 33 | 8 | 150 | 920 | 3 | 150 | • |
| 35 | 33 | X/7343-43 | T599X336M035ATE065 | 115.5 | 10 | 65 | 1949 | 3 | 150 | • |
| Facedown Construction | | | | | | | | | | |
| 2.5 | 100 | S/3216-12 | T597S107M2R5APE100 | 75 | 10 | 100 | 770 | 3 | 125 | • |
| 6.3 | 22 | P/2012-10 | T597P226M006APE200 | 41.6 | 10 | 200 | 354 | 3 | 125 | • |
| 6.3 | 33 | S/3216-12 | T597S336M006APE100 | 62.4 | 10 | 100 | 770 | 3 | 125 | • |
| 6.3 | 33 | S/3216-12 | T597S336M006APE200 | 62.4 | 10 | 200 | 570 | 3 | 125 | • |
| 6.3 | 47 | S/3216-12 | T597S476M006APE100 | 88.8 | 10 | 100 | 770 | 3 | 125 | • |
| 6.3 | 47 | S/3216-12 | T597S476M006APE200 | 88.8 | 10 | 200 | 570 | 3 | 125 | • |
| 10 | 22 | S/3216-12 | T597S226M010APE200 | 66 | 10 | 200 | 570 | 3 | 125 | • |
| VDC at 105°C | µF | KEMET/EIA | | µA at +25°C Max/5 Minutes | % at +25°C 120 Hz Max | mΩ at +25°C 100 kHz Max | mA at +45°C 100 kHz | Reflow Temp ≤ 260°C | °C | T598/T599 Only ¹ |
| Rated Voltage | Rated Cap | Case Code/ Case Size | KEMET Part Number | DC Leakage | DF | ESR | Maximum Allowable Ripple Current | MSL | Maximum Operating Temp | AEC-Q200 Qualified |

(1) To complete KEMET part number, insert M for ±20% or K for ±10%. Designates capacitance tolerance.

¹ T598 = AEC-Q200 qualified. T599 AEC-Q200 qualified 150°C and T591 = limited to 500 hours at 85°C/85% RH load.

Refer to Ordering Information for additional detail.

Part Numbers marked in blue font are "Under Development." Engineering samples available upon request.

Derating Guidelines

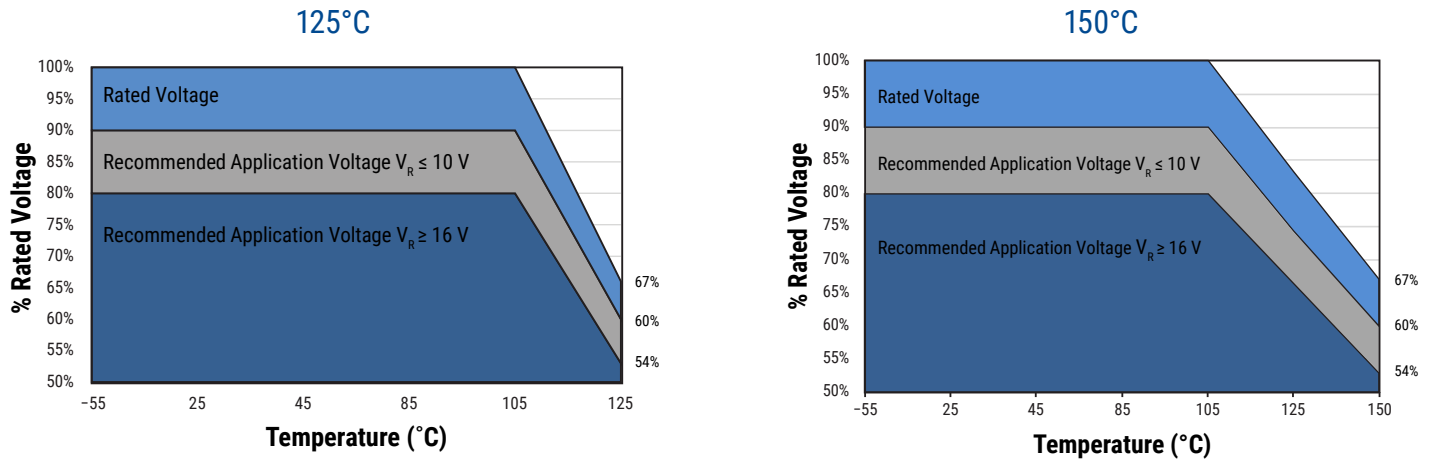

Recommended Application Voltage

KO-CAPs are solid state capacitors that demonstrate no wearout mechanism when operated within their recommended guidelines. While the KO-CAP can be operated at full rated voltage, most circuit designers seek a minimum level of assurance in long term reliability, which should be demonstrated with data. A voltage derating can provide the desired level of demonstrated reliability based on industry accepted acceleration models. Since most applications do require long term reliability, KEMET recommends that designers consider a voltage derating, according the graph above, for the maximum steady state voltage.

| Voltage Rating | Maximum Recommended Steady State Voltage | | |
|--|--|-----------------------|-----------------------|
| | -55°C to 105°C | 105°C to 125°C (T598) | 105°C to 150°C (T599) |
| $2.5\text{ V} \leq V_R \leq 10\text{ V}$ | 90% of V_R | 60% of V_R | 60% of V_R |
| $V_R \geq 16\text{ V}$ | 80% of V_R | 54% of V_R | 54% of V_R |

V_R = Rated voltage

Ripple Current/Ripple Voltage

Permissible AC ripple voltage and current are related to equivalent series resistance (ESR) and the power dissipation capabilities of the device. Permissible AC ripple voltage which may be applied is limited by two criteria:

1. The positive peak AC voltage plus the DC bias voltage, if any, must not exceed the DC voltage rating of the capacitor.
2. The negative peak AC voltage in combination with bias voltage, if any, must not exceed the allowable limits specified for reverse voltage. See the Reverse Voltage section for allowable limits.

The maximum power dissipation by case size can be determined using the table at right. The maximum power dissipation rating stated in the table must be reduced with increasing environmental operating temperatures. Refer to the table below for temperature compensation requirements.

| Case Code | EIA Case Code | Maximum Power Dissipation (Pmax) mWatts at 45°C with +30°C Rise |
|-----------|---------------|---|
| B | 3528-21 | 127 |
| D | 7343-31 | 225 |
| P | 2012-10 | 25 |
| S | 3216-12 | 60 |
| V | 7343-20 | 187 |
| X | 7343-43 | 247 |

Using the Pmax of the device, the maximum allowable rms ripple current or voltage may be determined.

$$I(max) = \sqrt{Pmax/R}$$

$$E(max) = Z \sqrt{Pmax/R}$$

- I* = rms ripple current (amperes)
- E* = rms ripple voltage (volts)
- Pmax* = maximum power dissipation (watts)
- R* = ESR at specified frequency (ohms)
- Z* = Impedance at specified frequency (ohms)

| Temperature Compensation Multipliers for Maximum Ripple Current | | | | |
|---|-----------------|------------------|-----------|-----------|
| T ≤ 45°C | 45°C < T ≤ 85°C | 85°C < T ≤ 105°C | T ≤ 125°C | T ≤ 150°C |
| 1.00 | 0.70 | 0.25 | 0.25 | 0.20 |

T = Environmental temperature

The maximum power dissipation rating must be reduced with increasing environmental operating temperatures. Refer to the Temperature Compensation Multiplier table for details.

Surge Voltage

Surge voltage is the maximum voltage (peak value) which may be applied to the capacitor. The surge voltage must not be applied for periodic charging and discharging in course of normal operation and cannot be part of the application voltage. Surge voltage capability is demonstrated by application of 1,000 cycles at operating temperature. The parts are charged through a 33 Ohm resistor for 30 seconds and then discharged through a 33 Ohm resistor for each cycle.

| Rated Voltage (V) | Surge Voltage (V) | Category Voltage (V) | Category Surge Voltage (V) | Category Voltage (V) | Category Surge Voltage (V) |
|-------------------|-------------------|----------------------|----------------------------|----------------------|----------------------------|
| -55°C to 105°C | | up to 125°C | | up to 150°C* | |
| 2.5 | 3.3 | 1.7 | 2.2 | 1.7 | 2.2 |
| 6.3 | 8.2 | 4.2 | 5.5 | 4.2 | 5.5 |
| 10 | 13 | 6.7 | 8.7 | 6.7 | 8.7 |
| 16 | 20.8 | 10.7 | 13.9 | 10.7 | 13.9 |
| 20 | 26 | 13.4 | 17.4 | 13.4 | 17.4 |
| 25 | 32.5 | 16.8 | 21.8 | 16.8 | 21.8 |
| 35 | 45.5 | 23.5 | 30.5 | 23.5 | 30.5 |
| 50 | 65 | 33.5 | 43.6 | 33.5 | 43.6 |

*T599 Only

Reverse Voltage

Polymer electrolytic capacitors are polar devices and may be permanently damaged or destroyed if connected in the wrong polarity. These devices will withstand a small degree of transient voltage reversal for short periods as shown in the below table.

| Temperature | Permissible Transient Reverse Voltage |
|-------------|---------------------------------------|
| 25°C | 15% of rated voltage |
| 55°C | 10% of rated voltage |
| 85°C | 5% of rated voltage |
| 105°C | 3% of rated voltage |
| 125°C* | 1% of rated voltage |
| 150°C** | 1% of rated voltage |

*For series rated to 125°C

** For series rated to 150°C

Table 2 – Land Dimensions/Courtyard

T591 / T598 / T599

| KEMET | Metric Size Code | Density Level A: Maximum (Most) Land Protrusion (mm) | | | | | Density Level B: Median (Nominal) Land Protrusion (mm) | | | | | Density Level C: Minimum (Least) Land Protrusion (mm) | | | | |
|----------------|------------------|--|------|------|-------|------|--|------|------|------|------|---|------|------|------|------|
| | | Case | EIA | W | L | S | V1 | V2 | W | L | S | V1 | V2 | W | L | S |
| B | 3528-21 | 2.35 | 2.21 | 0.92 | 6.32 | 4.00 | 2.23 | 1.80 | 1.12 | 5.22 | 3.50 | 2.13 | 1.42 | 1.28 | 4.36 | 3.24 |
| D | 7343-31 | 2.55 | 2.77 | 3.67 | 10.22 | 5.60 | 2.43 | 2.37 | 3.87 | 9.12 | 5.10 | 2.33 | 1.99 | 4.03 | 8.26 | 4.84 |
| V | 7343-21 | 2.55 | 2.77 | 3.67 | 10.22 | 5.60 | 2.43 | 2.37 | 3.87 | 9.12 | 5.10 | 2.33 | 1.99 | 4.03 | 8.26 | 4.84 |
| X ¹ | 7343-43 | 2.55 | 2.77 | 3.67 | 10.22 | 5.60 | 2.43 | 2.37 | 3.87 | 9.12 | 5.10 | 2.33 | 1.99 | 4.03 | 8.26 | 4.84 |

Density Level A: For low-density product applications. Recommended for wave solder applications and provides a wider process window for reflow solder processes.

Density Level B: For products with a moderate level of component density. Provides a robust solder attachment condition for reflow solder processes.

Density Level C: For high component density product applications. Before adapting the minimum land pattern variations the user should perform qualification testing based on the conditions outlined in IPC standard 7351 (IPC-7351).

¹ Height of these chips may create problems in wave soldering.

² Land pattern geometry is too small for silkscreen outline.

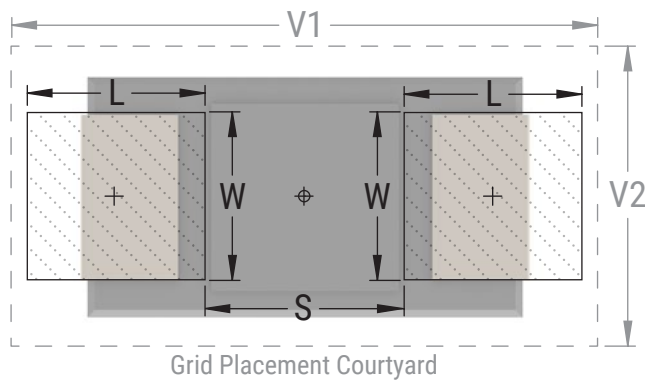

T597

| KEMET | Metric Size Code | Dimensions (mm) Minimum – Maximum | | | | |
|-------|------------------|-----------------------------------|-------------|-------------|------------|---|
| | | Case | EIA | G | Z | X |
| I | 3216-10 | 1.00 – 1.65 | 3.25 – 3.80 | 1.1 – 1.30 | 0.8 – 1.40 | |
| S | 3216-12 | 1.00 – 1.65 | 3.25 – 3.80 | 1.1 – 1.30 | 0.8 – 1.40 | |
| P | 2012-10 | 0.40 – 1.05 | 2.05 – 2.60 | 0.80 – 1.00 | 0.5 – 1.1 | |

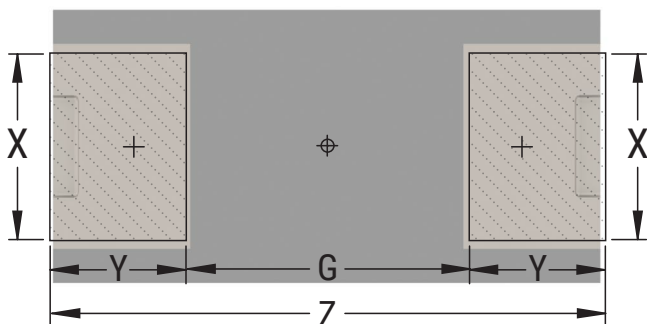

Soldering Process

KEMET's families of surface mount capacitors are compatible with wave (single or dual), convection, IR, or vapor phase reflow techniques. Preheating of these components is recommended to avoid extreme thermal stress. KEMET's recommended profile conditions for convection and IR reflow reflect the profile conditions of the IPC/J-STD-020D standard for moisture sensitivity testing. The devices can safely withstand a maximum of three reflow passes at these conditions.

Please note that although the X/7343-43 case size can withstand wave soldering, the tall profile (4.3 mm maximum) dictates care in wave process development.

Hand soldering should be performed with care due to the difficulty in process control. If performed, care should be taken to avoid contact of the soldering iron to the molded case. The iron should be used to heat the solder pad, applying solder between the pad and the termination, until reflow occurs. Once reflow occurs, the iron should be removed immediately. "Wiping" the edges of a chip and heating the top surface is not recommended.

| Profile Feature | SnPb Assembly | Pb-Free Assembly |
|---|--------------------|--------------------|
| Preheat/Soak | | |
| Temperature Minimum (T_{smin}) | 100°C | 150°C |
| Temperature Maximum (T_{smax}) | 150°C | 200°C |
| Time (t_s) from T_{smin} to T_{smax} | 60 – 120 seconds | 60 – 120 seconds |
| Ramp-up Rate (T_L to T_P) | 3°C/second maximum | 3°C/second maximum |
| Liquidous Temperature (T_L) | 183°C | 217°C |
| Time Above Liquidous (t_L) | 60 – 150 seconds | 60 – 150 seconds |
| Peak Temperature (T_P) | 220°C* 235°C** | 250°C* 260°C** |
| Time within 5°C of Maximum Peak Temperature (t_p) | 20 seconds maximum | 30 seconds maximum |
| Ramp-down Rate (T_P to T_L) | 6°C/second maximum | 6°C/second maximum |
| Time 25°C to Peak Temperature | 6 minutes maximum | 8 minutes maximum |

Note: All temperatures refer to the center of the package, measured on the package body surface that is facing up during assembly reflow.

* For Case Size height > 2.5 mm

** For Case Size height ≤ 2.5 mm

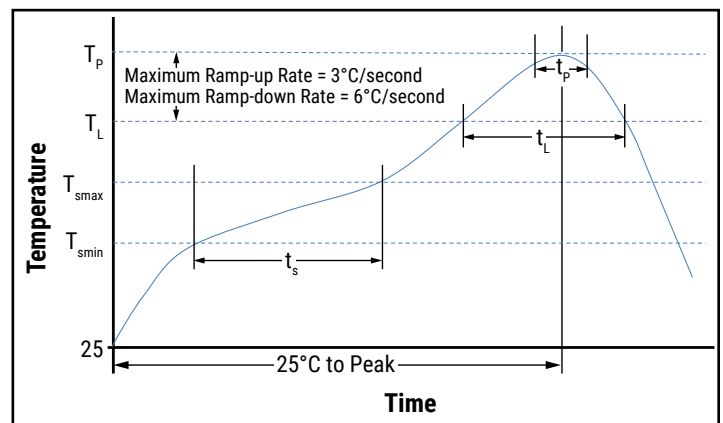

Storage

All KO-CAP capacitors are shipped in moisture barrier bags (MBBs) with desiccant and humidity indicator card (HIC). These parts are classified as moisture sensitivity level 3 (MSL3) per IPC/JEDEC J-STD-020 and packaged per IPC/JEDEC J-STD-033, MSL3 specifies a floor time of 168 H at 30°C maximum temperature and 60% relative humidity. Unused capacitors should be sealed in a MBB with fresh desiccant.

Calculated shelf life in sealed bag:

- 12 months from bag seal date in a storage environment of < 40°C and humidity < 90% RH
- 24 months from bag seal date in a storage environment of < 30°C and humidity < 70% RH

If baking is required, refer to IPC/JEDEC J-STD-033 for bake procedure.

Construction

T591 / T598 / T599

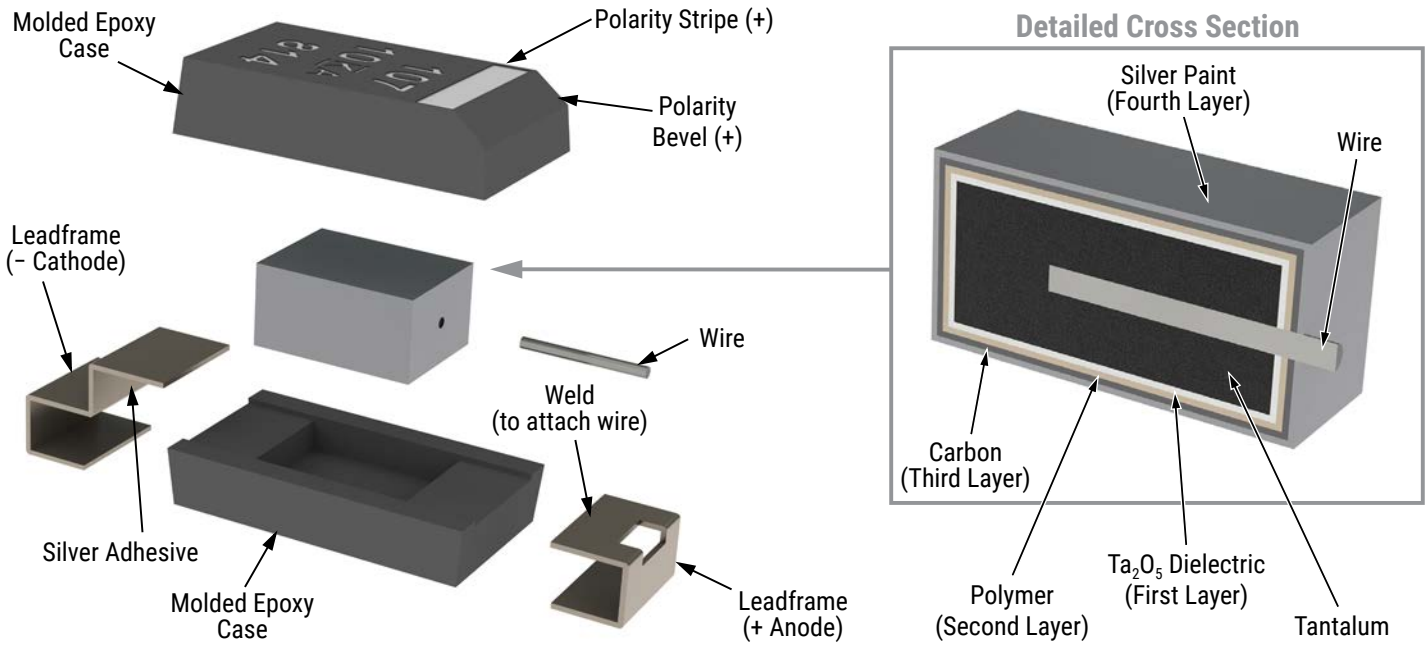

T597

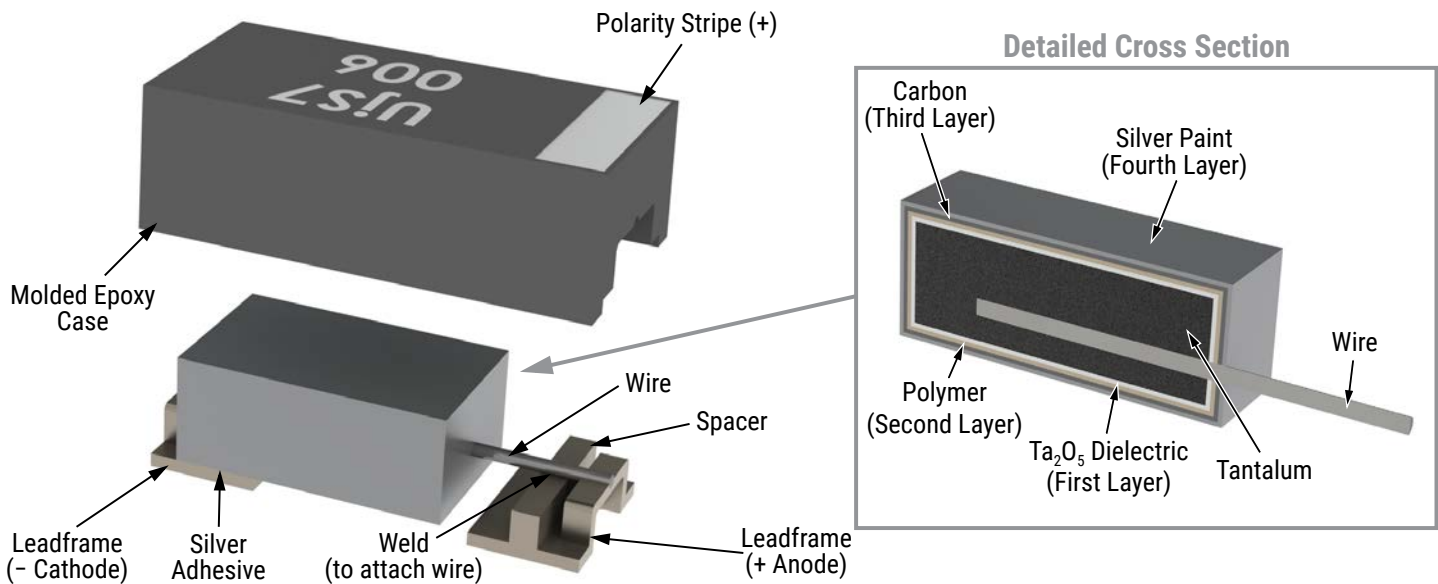

Capacitor Marking

T591/ T598 / T599

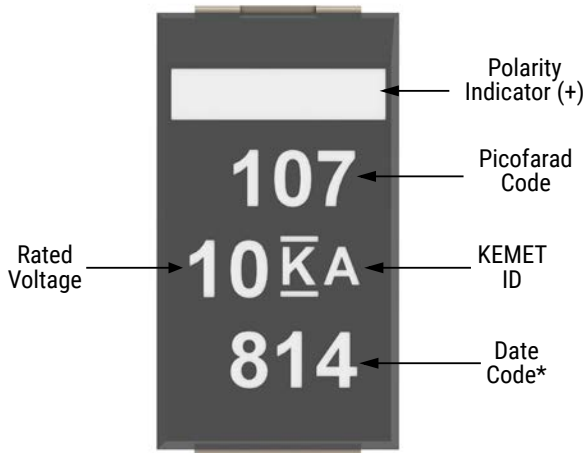

* 822 = 14th week of 2018

| Date Code * | |
|--|--|
| 1 st digit = Last number of year | 6 = 2016 7 = 2017 8 = 2018 9 = 2019 0 = 2020 |
| 2 nd and 3 rd digit = Week of the year | 01 = 1 st week of the year to 52 = 52 nd week of the year |

T597

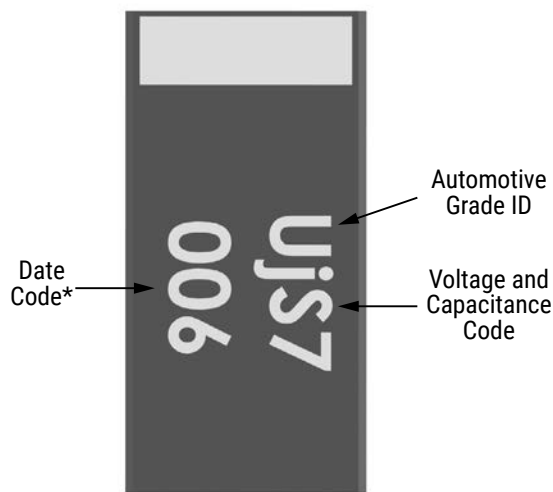

* 008 = 6th week of 2020

| Voltage Code | | |
|--------------|-------|------|
| e | j | A |
| 2.5 V | 6.3 V | 10 V |

| Capacitance Code | | | |
|------------------|----|----|-----|
| J7 | N7 | S7 | A8 |
| 22 | 33 | 47 | 100 |

| Date Code * | |
|--|--|
| 1 st digit = Last number of year | 8 = 2018 9 = 2019 0 = 2020 |
| 2 nd and 3 rd digit = Week of the year | 01 = 1 st week of the year to 52 = 52 nd week of the year |

Tape & Reel Packaging Information

KEMET’s molded chip capacitor families are packaged in 8 and 12 mm plastic tape on 7" and 13" reels in accordance with *EIA Standard 481: Embossed Carrier Taping of Surface Mount Components for Automatic Handling*. This packaging system is compatible with all tape-fed automatic pick-and-place systems.

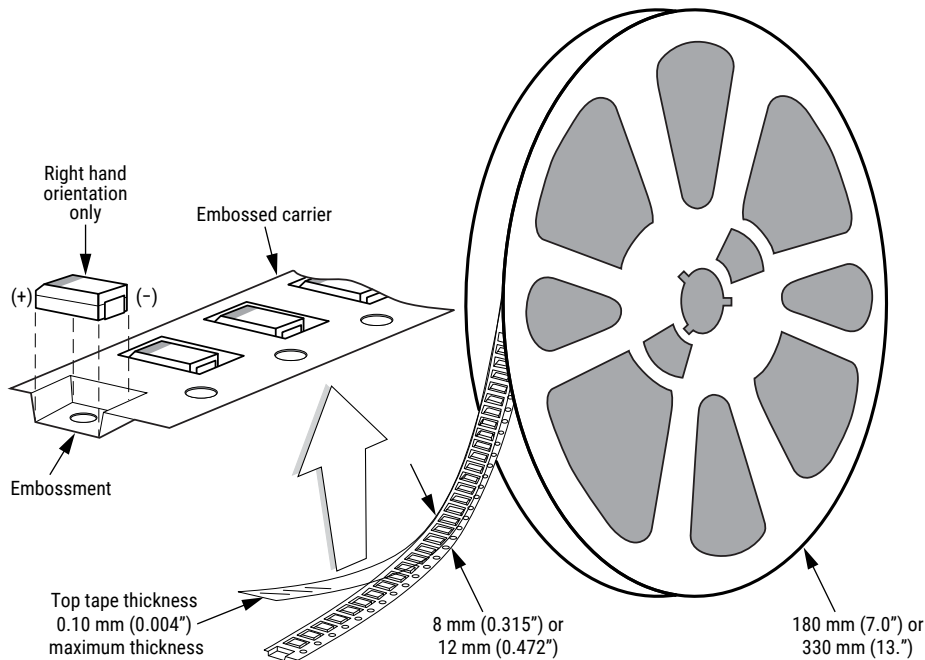

Table 3 – Packaging Quantity

| Case Code | | Tape Width (mm) | 7" Reel* | 13" Reel* |
|-----------|---------|-----------------|----------|-----------|
| KEMET | EIA | | | |
| P | 2012-10 | 8 | 3,000 | N/A |
| R | 2012-12 | 8 | 2,500 | 10,000 |
| I | 3216-10 | 8 | 3,000 | N/A |
| S | 3216-12 | 8 | 3,000 | N/A |
| A | 3216-18 | 8 | 2,000 | N/A |
| T | 3528-12 | 8 | 3,000 | 10,000 |
| M | 3528-15 | 8 | 2,500 | 8,000 |
| B | 3528-21 | 8 | 2,000 | 8,000 |
| U | 6032-15 | 12 | 1,000 | 5,000 |
| L | 6032-19 | 12 | 1,000 | 3,000 |
| C | 6032-28 | 12 | 500 | 3,000 |
| Q | 7343-12 | 12 | 1,000 | 3,000 |
| W | 7343-15 | 12 | 1,000 | 3,000 |
| Z | 7343-17 | 12 | 1,000 | 3,000 |
| V | 7343-19 | 12 | 1,000 | 3,000 |
| D | 7343-31 | 12 | 500 | 2,500 |
| Y | 7343-40 | 12 | 500 | 2,000 |
| X | 7343-43 | 12 | 500 | 2,000 |
| J | 7360-15 | 12 | 1,000 | 3,000 |
| H | 7360-20 | 12 | 1,000 | 3,000 |
| O | 7360-43 | 12 | 250 | 1,000 |

* No C-Spec required for 7" reel packaging. C-7280 required for 13" reel packaging.

Figure 1 – Embossed (Plastic) Carrier Tape Dimensions

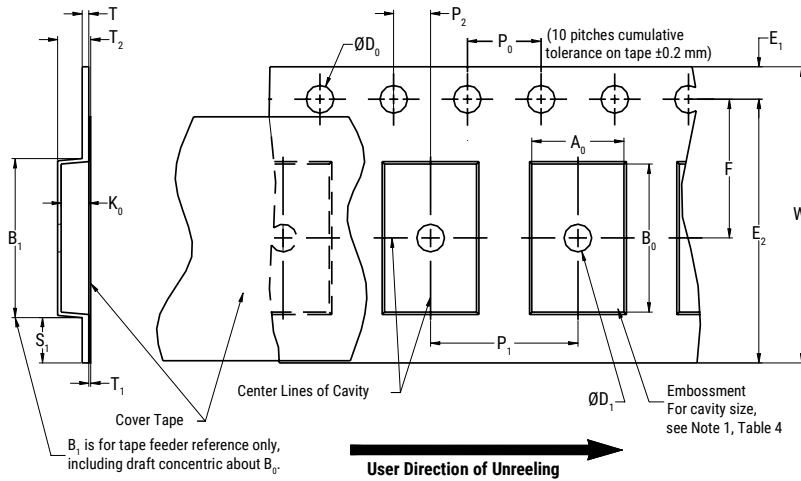

Table 4 – Embossed (Plastic) Carrier Tape Dimensions

Metric will govern

| Constant Dimensions – Millimeters (Inches) | | | | | | | | | |
|--|---------------------------------------|----------------------------------|------------------------------|-----------------------------|-----------------------------|-----------------------|----------------------------------|------------------|------------------------|
| Tape Size | D ₀ | D ₁ Minimum Note 1 | E ₁ | P ₀ | P ₂ | R Reference Note 2 | S ₁ Minimum Note 3 | T Maximum | T ₁ Maximum |
| 8 mm | 1.5 +0.10/-0.0 (0.059 +0.004/-0.0) | 1.0 (0.039) | 1.75 ±0.10 (0.069 ±0.004) | 4.0 ±0.10 (0.157 ±0.004) | 2.0 ±0.05 (0.079 ±0.002) | 25.0 (0.984) | 0.600 (0.024) | 0.600 (0.024) | 0.100 (0.004) |
| 12 mm | | 1.5 (0.059) | | | | | | | |

| Variable Dimensions – Millimeters (Inches) | | | | | | | | | |
|--|---------------------------------------|----------------------------------|------------------------|-----------------------------|--|------------------------|-----------------|--|--|
| Tape Size | Pitch | B ₁ Maximum Note 4 | E ₂ Minimum | F | P ₁ | T ₂ Maximum | W Maximum | A ₀ , B ₀ & K ₀ | |
| 8 mm | Single (4 mm) | 4.35 (0.171) | 6.25 (0.246) | 3.5 ±0.05 (0.138 ±0.002) | 2.0 ±0.05 or 4.0 ±0.10 (0.079 ±0.002 or 0.157 ±0.004) | 2.5 (0.098) | 8.3 (0.327) | Note 5 | |
| 12 mm | Single (4 mm) and Double (8 mm) | 8.2 (0.323) | 10.25 (0.404) | 5.5 ±0.05 (0.217 ±0.002) | 2.0 ±0.05 (0.079 ±0.002) or 4.0 ±0.10 (0.157 ±0.004) or 8.0 ±0.10 (0.315 ±0.004) | 4.6 (0.181) | 12.3 (0.484) | | |

1. The embossment hole location shall be measured from the sprocket hole controlling the location of the embossment. Dimensions of embossment location and hole location shall be applied independent of each other.
2. The tape, with or without components, shall pass around R without damage (see Figure 4).
3. If S₁ < 1.0 mm, there may not be enough area for cover tape to be properly applied (see EIA Standard 481-D, paragraph 4.3, section b).
4. B₁ dimension is a reference dimension for tape feeder clearance only.
5. The cavity defined by A₀, B₀ and K₀ shall surround the component with sufficient clearance that:
 - (a) the component does not protrude above the top surface of the carrier tape.
 - (b) the component can be removed from the cavity in a vertical direction without mechanical restriction, after the top cover tape has been removed.
 - (c) rotation of the component is limited to 20° maximum for 8 and 12 mm tapes (see Figure 2).
 - (d) lateral movement of the component is restricted to 0.5 mm maximum for 8 mm and 12 mm wide tape (see Figure 3).
 - (e) see Addendum in EIA Standard 481-D for standards relating to more precise taping requirements.

Packaging Information Performance Notes

- 1. Cover tape break force:** 1.0 kg minimum.
- 2. Cover tape peel strength:** The total peel strength of the cover tape from the carrier tape shall be:

| Tape Width | Peel Strength |
|------------|----------------------------------|
| 8 mm | 0.1 to 1.0 newton (10 to 100 gf) |
| 12 mm | 0.1 to 1.3 newton (10 to 130 gf) |

The direction of the pull shall be opposite the direction of the carrier tape travel. The pull angle of the carrier tape shall be 165° to 180° from the plane of the carrier tape. During peeling, the carrier and/or cover tape shall be pulled at a velocity of 300 ±10 mm/minute.

- 3. Labeling:** Bar code labeling (standard or custom) shall be on the side of the reel opposite the sprocket holes. Refer to EIA Standards 556 and 624.

Figure 2 – Maximum Component Rotation

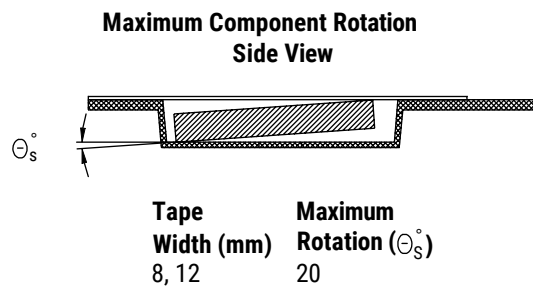
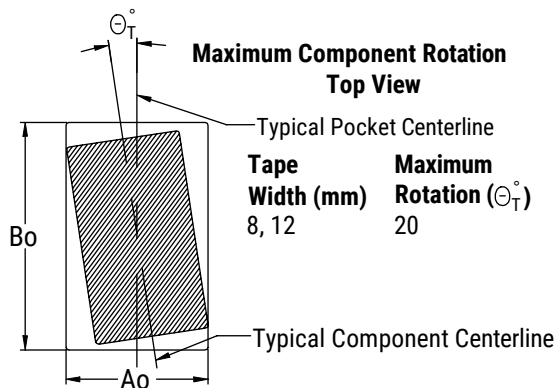

Figure 3 – Maximum Lateral Movement

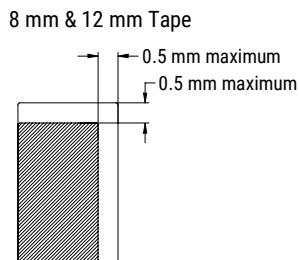

Figure 4 – Bending Radius

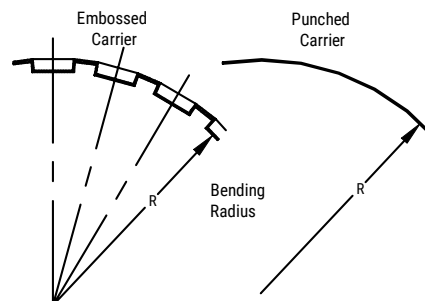
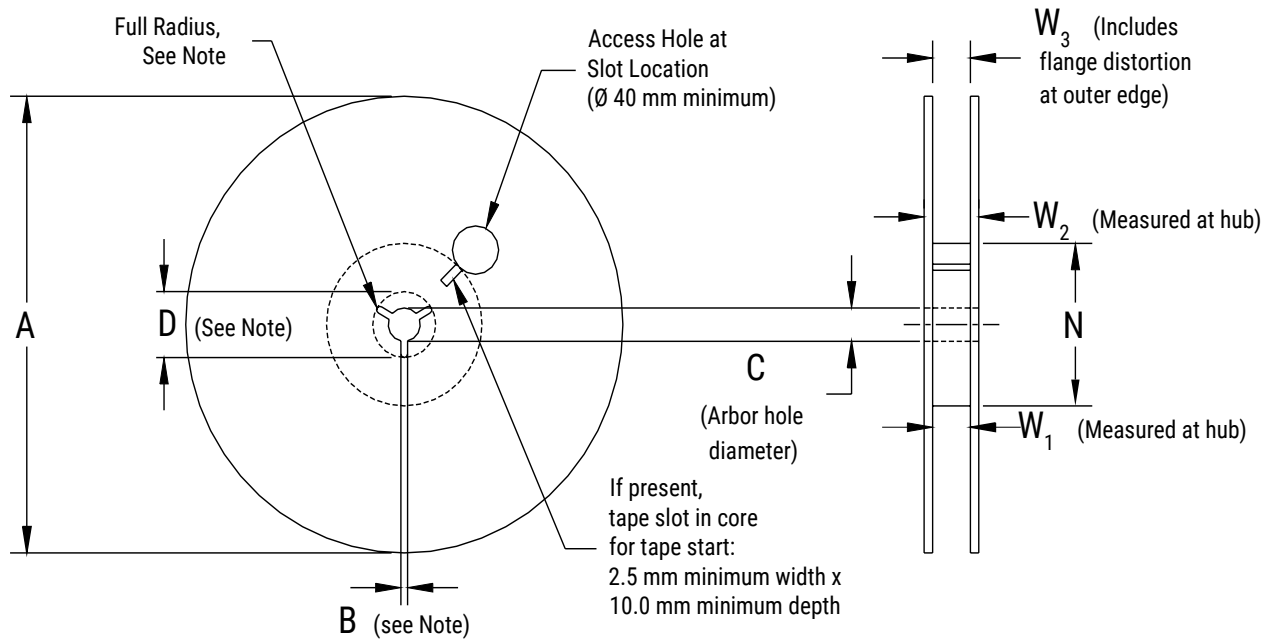

Figure 5 – Reel Dimensions



Note: Drive spokes optional; if used, dimensions B and D shall apply.

Table 5 – Reel Dimensions

Metric will govern

| Constant Dimensions – Millimeters (Inches) | | | | |
|--|------------------------------|---------------------------------------|--|---|
| Tape Size | A | B Minimum | C | D Minimum |
| 8 mm | 178 ±0.20 (7.008 ±0.008) | 1.5 (0.059) | 13.0 +0.5/-0.2 (0.521 +0.02/-0.008) | 20.2 (0.795) |
| 12 mm | 330 ±0.20 (13.000 ±0.008) | | | |
| Variable Dimensions – Millimeters (Inches) | | | | |
| Tape Size | N Minimum | W ₁ | W ₂ Maximum | W ₃ |
| 8 mm | 50 (1.969) | 8.4 +1.5/-0.0 (0.331 +0.059/-0.0) | 14.4 (0.567) | Shall accommodate tape width without interference |
| 12 mm | | 12.4 +2.0/-0.0 (0.488 +0.078/-0.0) | 18.4 (0.724) | |

Figure 6 – Tape Leader & Trailer Dimensions

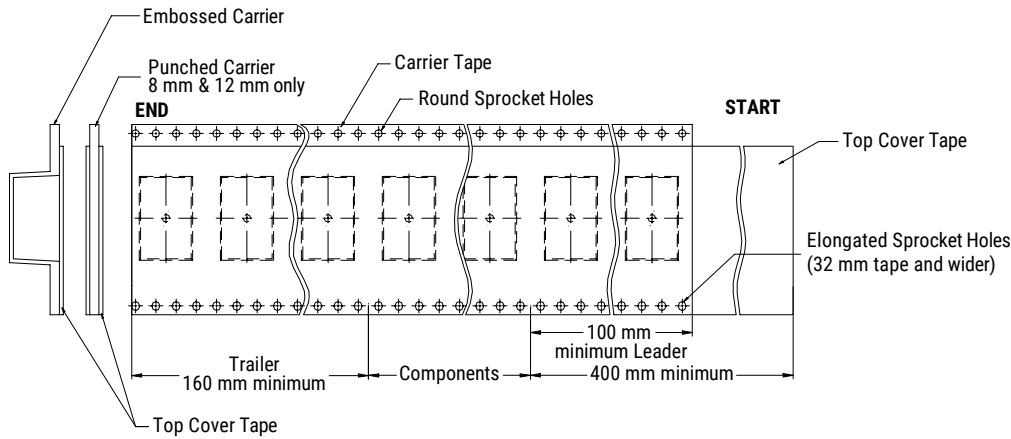
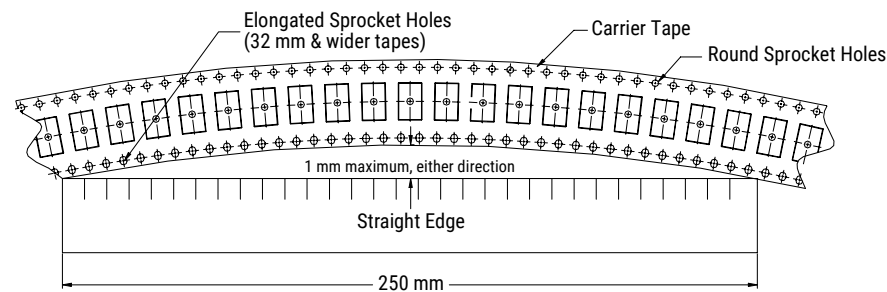

Figure 7 – Maximum Camber



KEMET Electronics Corporation Sales Offices

For a complete list of our global sales offices, please visit www.kemet.com/sales.

Disclaimer

All product specifications, statements, information and data (collectively, the "Information") in this datasheet are subject to change. The customer is responsible for checking and verifying the extent to which the Information contained in this publication is applicable to an order at the time the order is placed. All Information given herein is believed to be accurate and reliable, but it is presented without guarantee, warranty, or responsibility of any kind, expressed or implied.

Statements of suitability for certain applications are based on KEMET Electronics Corporation's ("KEMET") knowledge of typical operating conditions for such applications, but are not intended to constitute – and KEMET specifically disclaims – any warranty concerning suitability for a specific customer application or use. The Information is intended for use only by customers who have the requisite experience and capability to determine the correct products for their application. Any technical advice inferred from this Information or otherwise provided by KEMET with reference to the use of KEMET's products is given gratis, and KEMET assumes no obligation or liability for the advice given or results obtained.

Although KEMET designs and manufactures its products to the most stringent quality and safety standards, given the current state of the art, isolated component failures may still occur. Accordingly, customer applications which require a high degree of reliability or safety should employ suitable designs or other safeguards (such as installation of protective circuitry or redundancies) in order to ensure that the failure of an electrical component does not result in a risk of personal injury or property damage.

Although all product-related warnings, cautions and notes must be observed, the customer should not assume that all safety measures are indicated or that other measures may not be required.

KEMET is a registered trademark of KEMET Electronics Corporation.

Данный компонент на территории Российской Федерации

Вы можете приобрести в компании MosChip.

Для оперативного оформления запроса Вам необходимо перейти по данной ссылке:

<http://moschip.ru/get-element>

Вы можете разместить у нас заказ для любого Вашего проекта, будь то серийное производство или разработка единичного прибора.

В нашем ассортименте представлены ведущие мировые производители активных и пассивных электронных компонентов.

Нашей специализацией является поставка электронной компонентной базы двойного назначения, продукции таких производителей как XILINX, Intel (ex.ALTERA), Vicor, Microchip, Texas Instruments, Analog Devices, Mini-Circuits, Amphenol, Glenair.

Сотрудничество с глобальными дистрибьюторами электронных компонентов, предоставляет возможность заказывать и получать с международных складов практически любой перечень компонентов в оптимальные для Вас сроки.

На всех этапах разработки и производства наши партнеры могут получить квалифицированную поддержку опытных инженеров.

Система менеджмента качества компании отвечает требованиям в соответствии с ГОСТ Р ИСО 9001, ГОСТ РВ 0015-002 и ЭС РД 009

Офис по работе с юридическими лицами:

105318, г.Москва, ул.Щербаковская д.3, офис 1107, 1118, ДЦ «Щербаковский»

Телефон: +7 495 668-12-70 (многоканальный)

Факс: +7 495 668-12-70 (доб.304)

E-mail: info@moschip.ru

Skype отдела продаж:

moschip.ru

moschip.ru_4

moschip.ru_6

moschip.ru_9