

2A LED DRIVER with INTERNAL SWITCH

Description

The PAM2863 is a continuous mode inductive step-down converter, designed for driving single or multiple series connected LEDs efficiently from a voltage source higher than the LED voltage. The device operates from an input supply between 4.5V and 40V and provides an externally adjustable output current of up to 2A. Depending upon supply voltage and external components, this can provide up to 30 watts of output power.

The PAM2863 includes the output switch and a high-side output current sensing circuit, which uses an external resistor to set the nominal average output current.

Output current can be adjusted below the set value, by applying an external control signal to the VSET pin.

The VSET pin will accept either a DC voltage or a PWM waveform.

The soft-start time can be increased using an external capacitor from the VSET pin to ground. Applying a voltage of 0.2V or lower to the VSET pin turns the output off and switches the device into a low current standby state.

Features

- Simple Low Parts Count
- Internal 40V NDMOS Switch
- 2A Output Current
- Single Pin On/Off and Brightness Control Using DC Voltage or PWM
- Soft-Start
- High Efficiency (up to 97%)
- Wide Input Voltage Range: 4.5V to 40V
- Output Shutdown
- Open LED Protection
- Short LED Protection
- Up to 1MHz Switching Frequency
- Typical 5% Output Current Accuracy
- Pb-Free SOP-8(EP) Packages

Pin Assignments

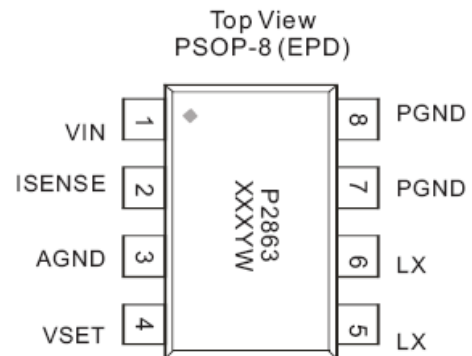

Applications

- High End LED Flashlight
- LED Light Bar

Typical Applications Circuit

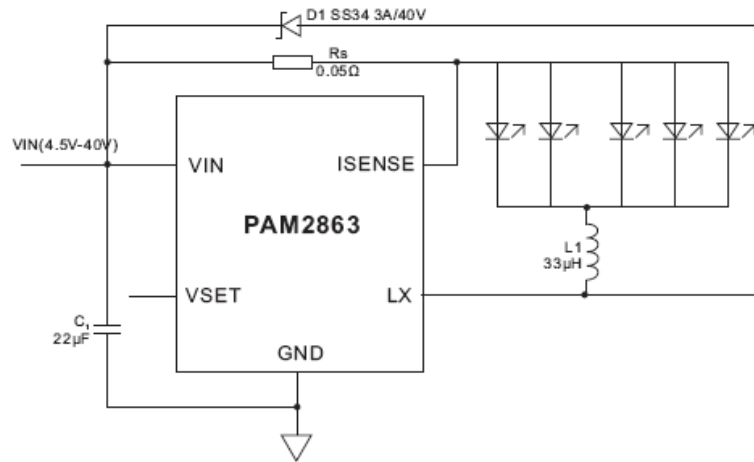

Pin Descriptions

Pin Number	Pin Name	Function
5, 6	LX	Drain of NDMOS switch.
3, 7, 8	GND	Ground (0V)
4	VSET	<ul style="list-style-type: none"> Multi-function On/Off and brightness control pin: Leave floating for normal operation. Drive to voltage below 0.2V to turn off output current Drive with DC voltage ($0.3V < VSET < 2.5V$) to adjust output current from 12% to 100% of I_{OUTnom} Drive with PWM signal from open-collector or open-drain transistor, to adjust output current. Adjustment range 1% to 100% of I_{OUTnom} for $f < 500Hz$ Connect a capacitor from this pin to ground to increase soft-start time. (Default soft-start time = 0.1ms. Additional soft-start time is approx. $1.5ms/1nF$)
2	ISENSE	Connect resistor R_S from this pin to VIN to define nominal average output current $I_{OUTnom} = 0.1/R_S$
1	VIN	Input voltage (6V to 40V). Decouple to ground with $10\mu F$ or higher X7R ceramic capacitor close to device.

Functional Block Diagram

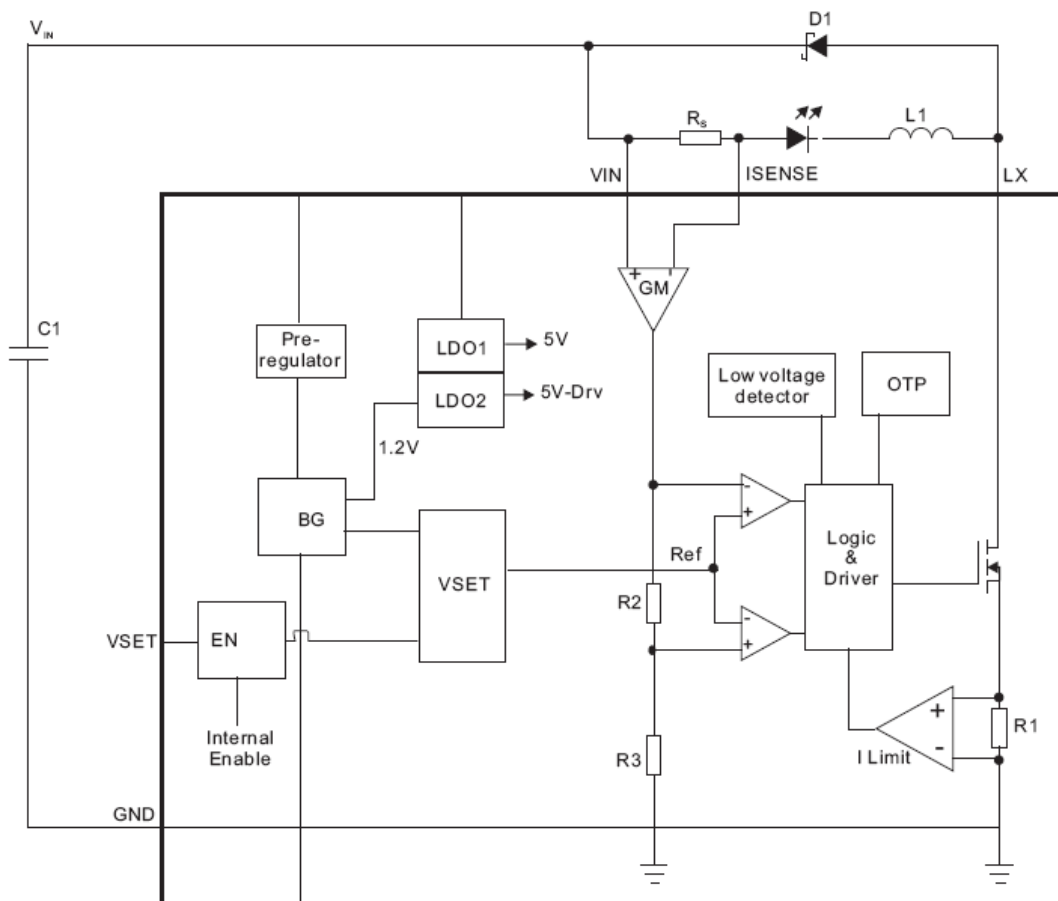

Absolute Maximum Ratings (@TA = +25°C, unless otherwise specified.)

These are stress ratings only and functional operation is not implied. Exposure to absolute maximum ratings for prolonged time periods may affect device reliability. All voltages are with respect to ground.

Parameter	Rating	Unit
Input Voltage Range	-0.3 to +40	V
LX, ISENSE Pin Voltage	-0.3 to +40	
VSET Pin Voltage	-0.3 to +6.0	
Maximum Junction Temperature	170	°C
Storage Temperature	-65 to +170	
Soldering Temperature	300, 5sec	

Recommended Operating Conditions (@TA = +25°C, unless otherwise specified.)

Parameter	Rating	Unit
Input Voltage Range	4.5 to 40	V
Ambient Temperature Range	-40 to +85	°C
Junction Temperature Range	-40 to +125	°C

Thermal Information

Parameter	Package	Symbol	Max	Unit
Thermal Resistance (Junction to Ambient)	SOP-8(EP)	θ_{JA}	90	°C/W
Thermal Resistance (Junction to Case)	SOP-8(EP)	θ_{JC}	11	

Electrical Characteristics (@T_A = +25°C, V_{IN} = 16V, unless otherwise specified.)

Parameter	Symbol	Test Conditions	Min	Typ	Max	Units
Inout Voltage	V _{IN}		4.5		40	V
Output Current	I _{LED}	R _S = 0.1Ω		1		A
		R _S = 0.05Ω		2		A
Shutdown Current	I _{SD}	VSET Pin Grounded		20	40	μA
Quiescent Current without Switching	I _Q	VSET Pin Floating, V _{IN} = 16V		0.6		mA
Mean Current Sense Threshold Voltage	V _{SENSE}	Measured on I _{SENSE} Pin with Respect to V _{IN}	95	100	105	mV
Sense Threshold Hysteresis	V _{SENSE_HYS}			±13		%
I _{SENSE} Pin Input Current	I _{SENSE}	V _{SENSE} = V _{IN} - 0.1		8		μA
VSET Range on VSET Pin	V _{EN}	For DC Dimming	0.3		2.5	V
DC Voltage on VSET Pin to Enable	V _{EN(ON)}	V _{EN} Rising		0.25		V
DC Voltage on VSET Pin to Disable	V _{EN(OFF)}	V _{EN} Falling		0.2		V
LX Switch on Resistance	R _{LX}	@I _{LX} = 100mA		0.3		Ω
LX Switch Leakage Current	I _{LX(LEAK)}				5	μA
Soft-Start Time	T _{SS}	V _{IN} = 16V, C _{EN} = 1nF		1.5		Ms
Operating Frequency	F _{LX}	V _{IN} = 16V, V _O = 9.6V (3 LEDs), L = 47μH, ΔI = 0.25A (I _{LED} = 1A)		233		kHz
Recommended Minimum Switch ON Time	T _{ON_REC}	For 4% Accuracy		500		Ns
Recommended Maximum Switch Frequency	F _{LX(MAX)}				1.0	MHz
Max Duty Circle				98		%
Recommended Duty Cycle Range	D _{LX}		25		75	%
Internal Comparator Propagation Delay	T _{PD} (Note 1)			45		Ns
Over Temperature Protection	T _{OTP}			150		°C
Temp Protection Hysteresis	T _{OTP_HYS}			40		°C
Current Limit	I _{XL(MAX)}	Peak Inductor Current		2.5		A

Note: 1. V_{SENSE}: LevelA: 95mV to 100mV; level B: 100mV to 105mV
Parameters are not tested at production, but guaranteed by design.

Typical Performance Characteristics (@ $T_A = +25^\circ\text{C}$, $V_{IN} = 16\text{V}$, unless otherwise specified.)

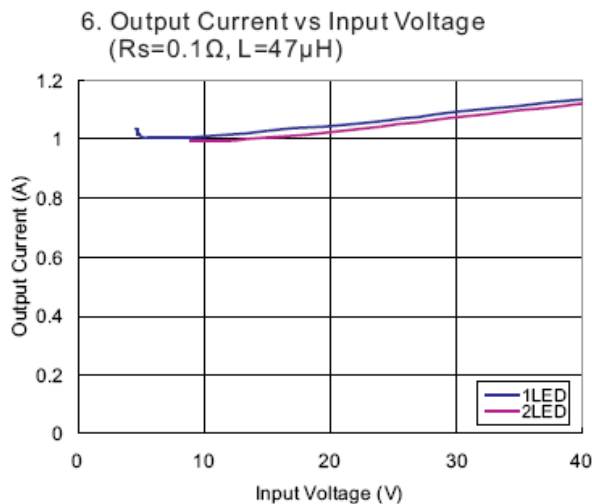
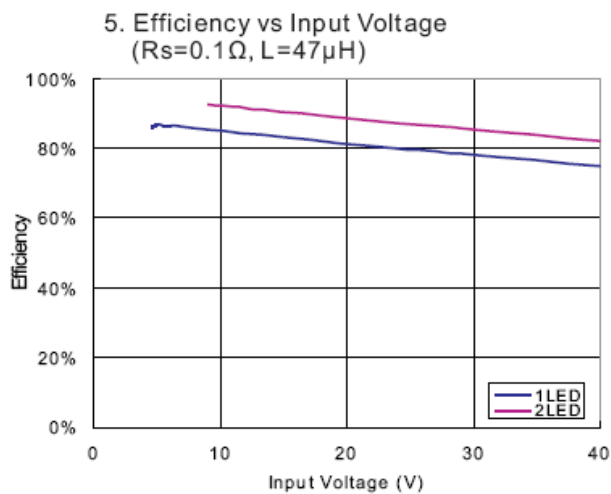
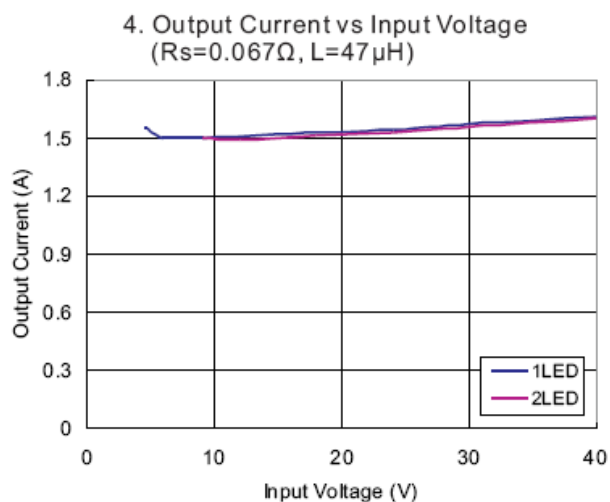
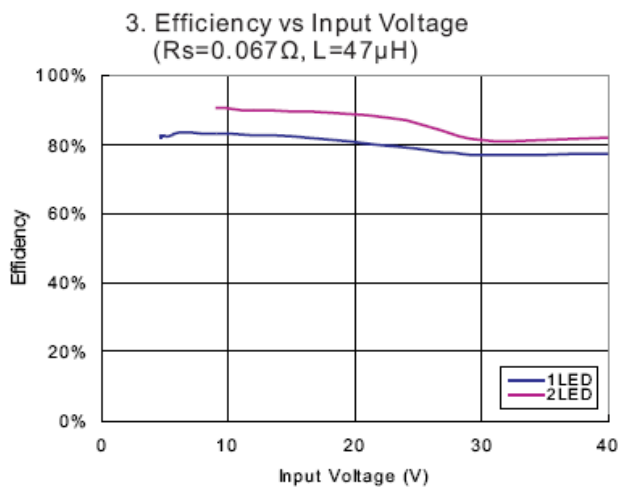
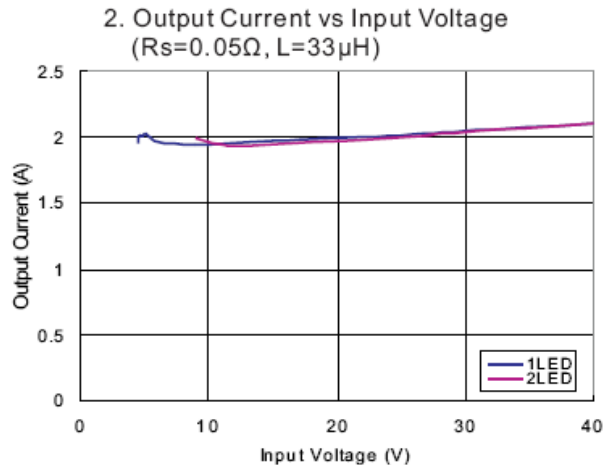
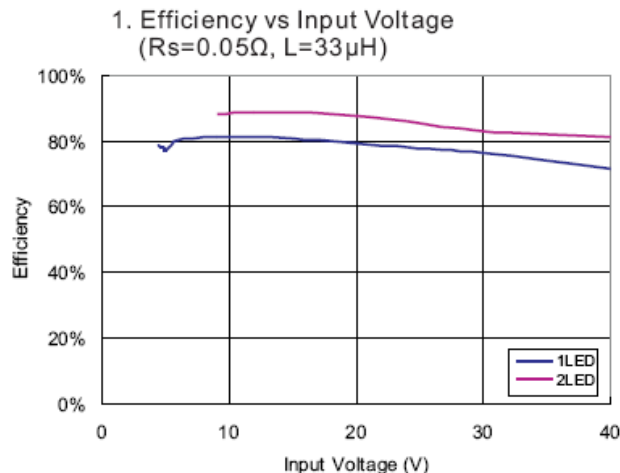

Typical Performance Characteristics (cont.) (@ $T_A = +25^\circ\text{C}$, $V_{IN} = 16\text{V}$, unless otherwise specified.)

7. Quiescent Current VS. Input Voltage

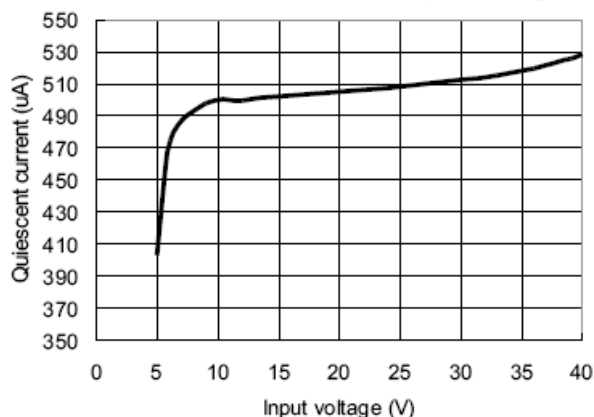

8. Shutdown Current VS. Input Voltage

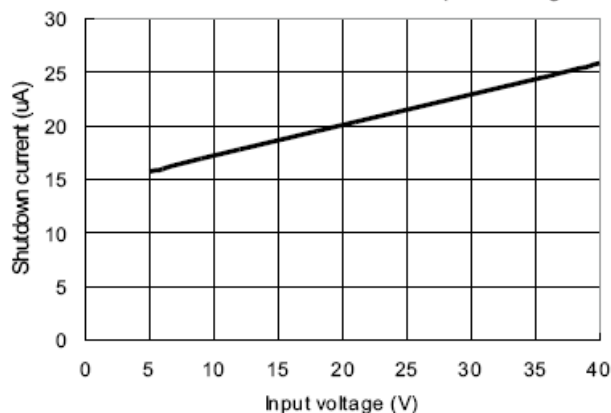

9. Feedback Voltage VS Vin

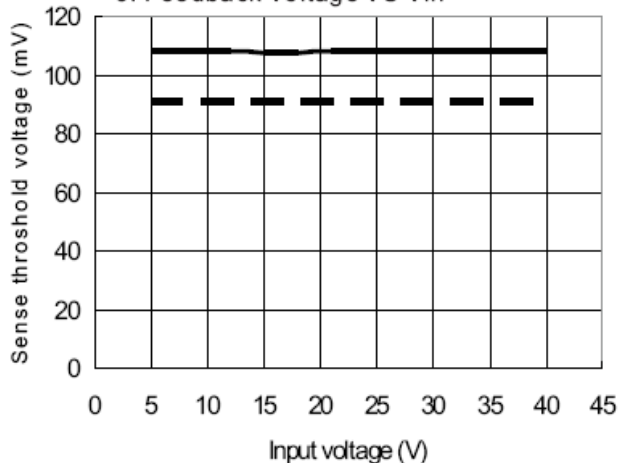

10. Duty Cycle VS LED Current (PWM=200Hz)

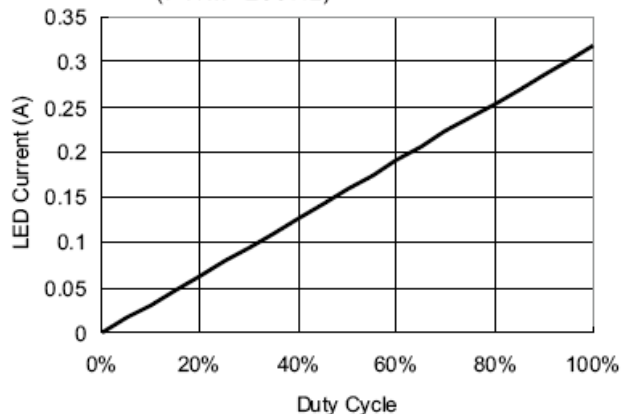

11. I_{LED} VS V_{SET}
($V_{IN} = 16\text{V}$, 3 LEDs, $47\mu\text{H}$, $R_s = 0.15\Omega$)

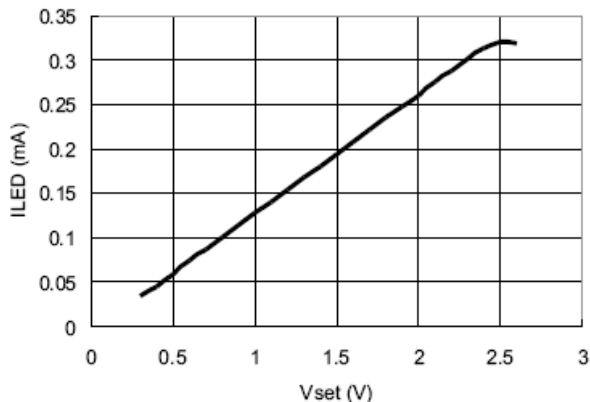

12. I_{LED} VS V_{SET}
($V_{IN} = 16\text{V}$, 3 LEDs, $100\mu\text{H}$, $R_s = 0.3\Omega$)

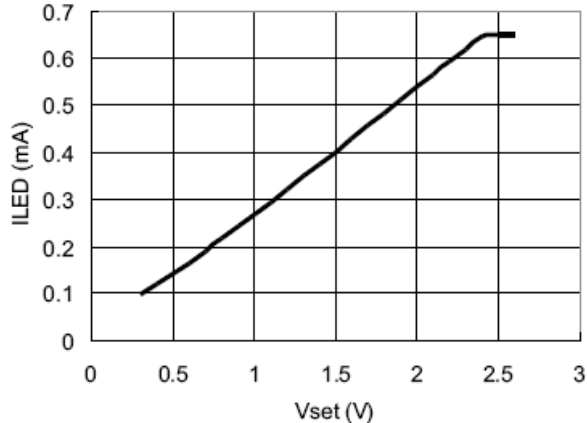

Typical Performance Characteristics (cont.) (@T_A = +25°C, V_{IN} = 16V, unless otherwise specified.)

13. Steady State Waveforms



14. Start up Waveforms

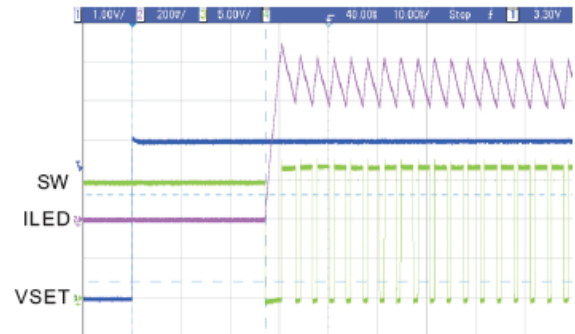

15. Dimming Waveforms (PWM=50%)

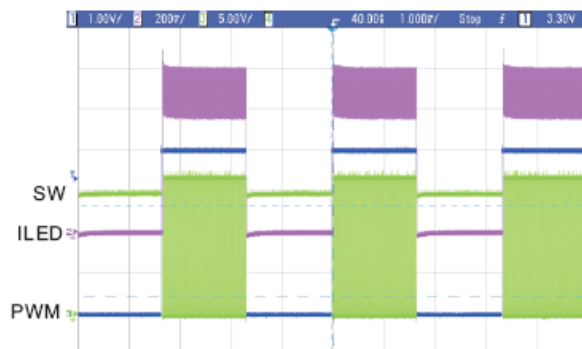

16. Pulse skip mode

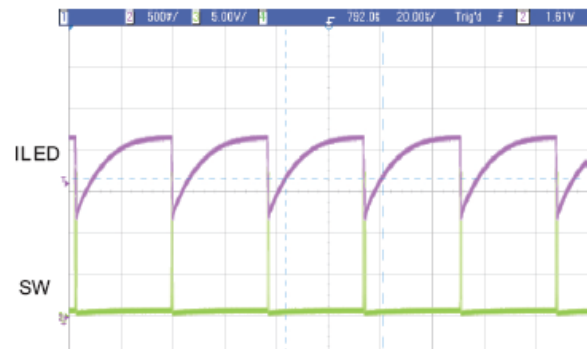

Application Information

Setting Nominal Average Output Current with External Resistor R_S

The nominal average output current in the LED(s) is determined by the value of the external current sense resistor (R_S) connected between V_{IN} and I_{SENSE} and is given by:

$$I_{OUT(NOM)} = \frac{0.1}{R_S}$$

The table below gives values of nominal average output current for several preferred values of current setting resistor (R_S) in the typical application circuit shown on page 1.

R_S (Ω)	Nominal Average Output Current (mA)
0.05	2000
0.067	1500
0.1	1000
0.13	760
0.15	667
0.3	333

The above values assume that the V_{SET} pin is floating and at a nominal voltage of V_{REF} (2.5V). Note that $R_S = 0.1\Omega$ is the minimum allowed value of sense resistor under these conditions to maintain switch current below the specified maximum value. It is possible to use different values of R_S if the V_{SET} pin is driven from an external voltage.

Capacitor Selection

A low ESR capacitor should be used for input decoupling, as the ESR of this capacitor appears in series with the supply source impedance and lowers overall efficiency. This capacitor has to supply the relatively high peak current to the coil and smooth the current ripple on the input supply. A minimum value of $10\mu F$ is acceptable if the input source is close to the device, but higher values will improve performance at lower input voltages, especially when the source impedance is high. The input capacitor should be placed as close as possible to the IC.

For maximum stability over temperature and voltage, capacitors with X7R, X5R, or better dielectric are recommended. Capacitors with Y5V dielectric are not suitable for decoupling in this application and should NOT be used.

Inductor Selection

Recommended inductor values for the PAM2863 are in the range $33\mu H$ to $100\mu H$. Higher values of inductance are recommended at higher supply voltages in order to minimize errors due to switching delays, which in increased ripple and lower efficiency. Higher values of inductance also result in a smaller change in output current over the supply voltage range. The inductor should be mounted as close to the device as possible with low resistance connections to the LX and V_{IN} pins. The chosen coil should have a saturation current higher than the peak output current and a continuous current rating above the required mean output current.

The inductor value should be chosen to maintain operating duty cycle and switch 'on'/'off' times within the specified limits over the supply voltage and load current range. The following equations can be used as a guide.

LX Switch 'On' time

$$T_{ON} = \frac{L\Delta I}{V_{IN} - V_{LED} - I_{LED}(R_S + R_L + R_{LX})}$$

Lx Switch 'Off' time

$$T_{OFF} = \frac{L\Delta I}{V_{LED} + V_D + I_{LED}(R_S + R_L)}$$

Where: L is the coil inductance; R_L is the coil resistance; R_S is the current sense resistance; I_{LED} is the required LED current; ΔI is the coil peak-peak ripple current (Internally set to $0.25 \times I_{LED}$); V_{IN} is the supply voltage; V_{LED} is the total LED forward voltage; R_{LX} is the switch resistance (0.3Ω nominal); V_D is the diode forward voltage at the required load current

Ordering Information

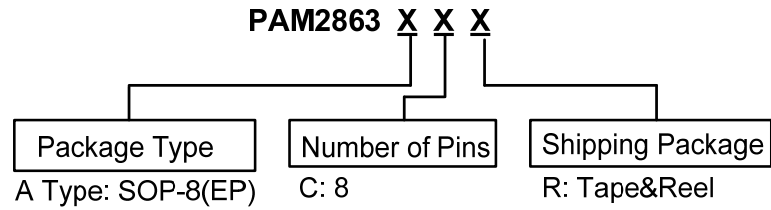

Part Number	Part Marking	Package Type	Standard Package
PAM2863ECR	P2863 XXXYYW	SOP-8(EP)	2500 Units/ Tape&Reel

Marking Information

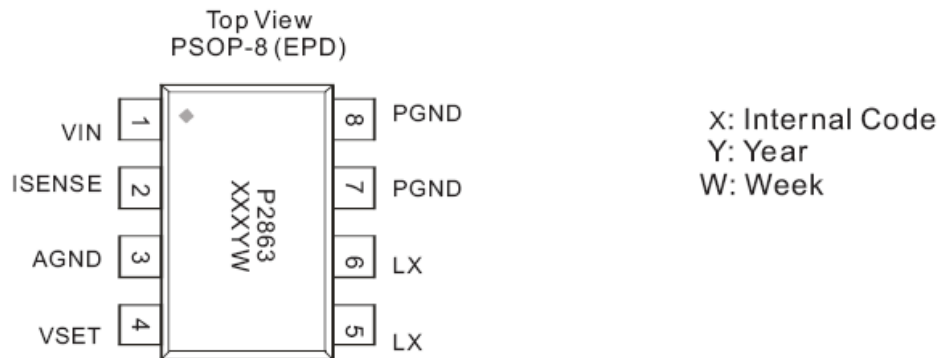

Package Outline Dimensions (All dimensions in mm.)

SOP-8(EP)

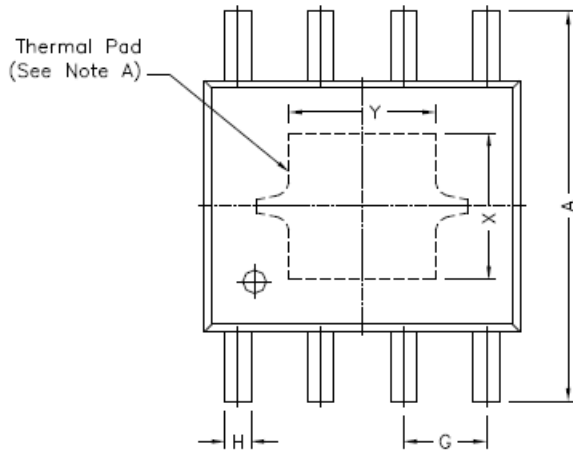

REF.	DIMENSIONS	
	Millimeters	
	Min.	Max.
A	5.80	6.20
B	4.80	5.00
C	3.80	4.00
D	0°	8°
E	0.40	0.90
F	0.19	0.25
M	0	0.15
H	0.35	0.49
L	1.35	1.75
G	1.27 TYP.	
Option1	X	2.28
	Y	2.28
Option2	X	2.41
	Y	3.30

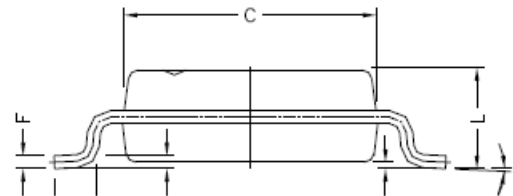
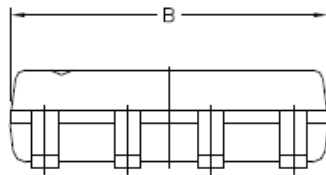

IMPORTANT NOTICE

DIODES INCORPORATED MAKES NO WARRANTY OF ANY KIND, EXPRESS OR IMPLIED, WITH REGARDS TO THIS DOCUMENT, INCLUDING, BUT NOT LIMITED TO, THE IMPLIED WARRANTIES OF MERCHANTABILITY AND FITNESS FOR A PARTICULAR PURPOSE (AND THEIR EQUIVALENTS UNDER THE LAWS OF ANY JURISDICTION).

Diodes Incorporated and its subsidiaries reserve the right to make modifications, enhancements, improvements, corrections or other changes without further notice to this document and any product described herein. Diodes Incorporated does not assume any liability arising out of the application or use of this document or any product described herein; neither does Diodes Incorporated convey any license under its patent or trademark rights, nor the rights of others. Any Customer or user of this document or products described herein in such applications shall assume all risks of such use and will agree to hold Diodes Incorporated and all the companies whose products are represented on Diodes Incorporated website, harmless against all damages.

Diodes Incorporated does not warrant or accept any liability whatsoever in respect of any products purchased through unauthorized sales channel. Should Customers purchase or use Diodes Incorporated products for any unintended or unauthorized application, Customers shall indemnify and hold Diodes Incorporated and its representatives harmless against all claims, damages, expenses, and attorney fees arising out of, directly or indirectly, any claim of personal injury or death associated with such unintended or unauthorized application.

Products described herein may be covered by one or more United States, international or foreign patents pending. Product names and markings noted herein may also be covered by one or more United States, international or foreign trademarks.

This document is written in English but may be translated into multiple languages for reference. Only the English version of this document is the final and determinative format released by Diodes Incorporated.

LIFE SUPPORT

Diodes Incorporated products are specifically not authorized for use as critical components in life support devices or systems without the express written approval of the Chief Executive Officer of Diodes Incorporated. As used herein:

A. Life support devices or systems are devices or systems which:

1. are intended to implant into the body, or
2. support or sustain life and whose failure to perform when properly used in accordance with instructions for use provided in the labeling can be reasonably expected to result in significant injury to the user.

B. A critical component is any component in a life support device or system whose failure to perform can be reasonably expected to cause the failure of the life support device or to affect its safety or effectiveness.

Customers represent that they have all necessary expertise in the safety and regulatory ramifications of their life support devices or systems, and acknowledge and agree that they are solely responsible for all legal, regulatory and safety-related requirements concerning their products and any use of Diodes Incorporated products in such safety-critical, life support devices or systems, notwithstanding any devices- or systems-related information or support that may be provided by Diodes Incorporated. Further, Customers must fully indemnify Diodes Incorporated and its representatives against any damages arising out of the use of Diodes Incorporated products in such safety-critical, life support devices or systems.

Copyright © 2012, Diodes Incorporated

www.diodes.com

Данный компонент на территории Российской Федерации

Вы можете приобрести в компании MosChip.

Для оперативного оформления запроса Вам необходимо перейти по данной ссылке:

<http://moschip.ru/get-element>

Вы можете разместить у нас заказ для любого Вашего проекта, будь то серийное производство или разработка единичного прибора.

В нашем ассортименте представлены ведущие мировые производители активных и пассивных электронных компонентов.

Нашей специализацией является поставка электронной компонентной базы двойного назначения, продукции таких производителей как XILINX, Intel (ex.ALTERA), Vicor, Microchip, Texas Instruments, Analog Devices, Mini-Circuits, Amphenol, Glenair.

Сотрудничество с глобальными дистрибьюторами электронных компонентов, предоставляет возможность заказывать и получать с международных складов практически любой перечень компонентов в оптимальные для Вас сроки.

На всех этапах разработки и производства наши партнеры могут получить квалифицированную поддержку опытных инженеров.

Система менеджмента качества компании отвечает требованиям в соответствии с ГОСТ Р ИСО 9001, ГОСТ РВ 0015-002 и ЭС РД 009

Офис по работе с юридическими лицами:

105318, г.Москва, ул.Щербаковская д.3, офис 1107, 1118, ДЦ «Щербаковский»

Телефон: +7 495 668-12-70 (многоканальный)

Факс: +7 495 668-12-70 (доб.304)

E-mail: info@moschip.ru

Skype отдела продаж:

moschip.ru

moschip.ru_4

moschip.ru_6

moschip.ru_9