

1

2

3

4

5

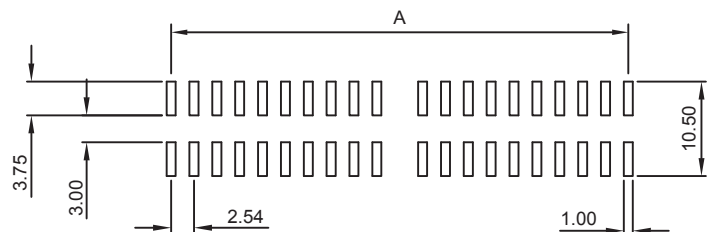

PCB LAYOUT - COMPONENT VIEW
TOLERANCE ±0.05MM

TECHNICAL CHARACTERISTICS

MATERIAL
INSULATOR: PA 9T
FLAMMABILITY: UL94-V0
COLOR: BLACK
CONTACT MATERIAL: COPPER ALLOYS
CONTACT TYPE: STAMPED
CONTACT PLATING: GOLD
QUALITY CLASS: 3 AS PER CECC 75 301-802
PITCH: 2.54MM

ENVIRONMENTAL
OPERATING TEMPERATURE: -40°C UP TO 105°C
COMPLIANCE: LEAD FREE AND ROHS

ELECTRICAL
CURRENT RATING: 3A MAX
WORKING VOLTAGE: 250 VAC
INSULATOR RESISTANCE: >5000 MΩ
DIELECTRIC WITHSTANDING VOLTAGE: 1000 VAC/MIN
CONTACT RESISTANCE: 20 mΩ MAX

STANDARD
AEC Q200 CERTIFIED: E323964

SOLDERING
JEDEC LEAD FREE REFLOW SOLDERING

PACKAGING
TAPE & REEL WITH CAP

DIMENSION
A = 2.54 x NB PINS/2 - 2.54
B = 2.54 x NB PINS/2 + 5.2
C = 2.54 x NB PINS/2 + 7.5

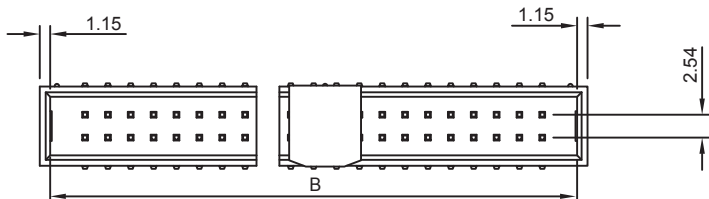
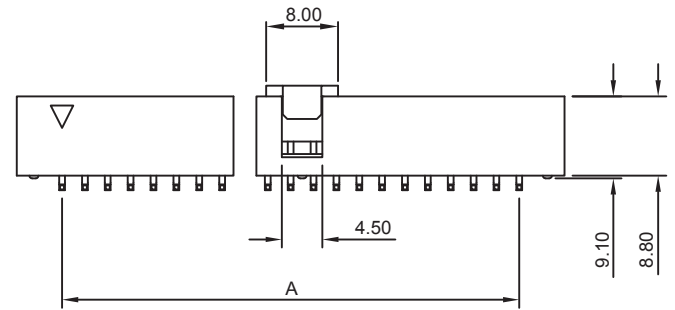
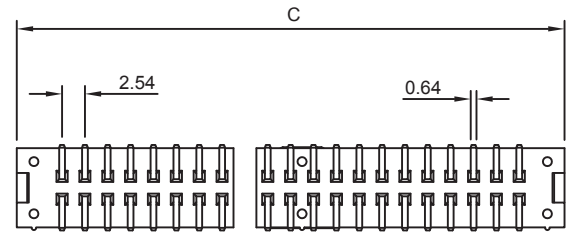
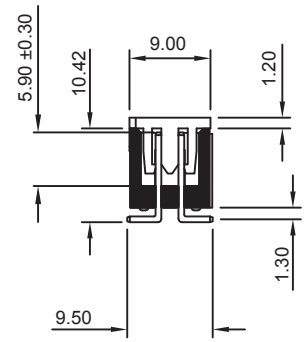

RoHS Compliant			
L	10-NOV-14	GENERAL UPDATE	AS
K	08-APR-14	DIM B => 18.02	QL
J	13-JUN-13	DIM 5.08	QL
I	22-JUL-11	W DIMENTION	QL
H	24-MAY-11	NOTE	GG
REV	DATE	FILE	BY

PROJECTION:

APPROVAL: GMo

GENERAL TOLERANCE
.X = +/- 0.2
.XX = +/- 0.15

UNIT: MM
SCALE:
SHEET: 1/3
DRAW: AS



DESCRIPTION: WR-BHD - 2.54MM MALE SMT BOX HEADER
WERI PART NO: 612 3xx 206 21

SIZE
A4

A

B

C

D

1

2

3

4

5

ITEM	A0	K0	K1	P	E	D	D1	P0	P2
DIM	9.8 ^{+0.1} _{-0.1}	11.9 ^{+0.1} _{-0.1}	0 ^{+0.1} _{-0.1}	20 ^{+0.1} _{-0.1}	1.75 ^{+0.1} _{-0.1}	1.5 ^{+0.1} _{-0.0}	2.0 ^{+0.25} _{-0.0}	4.0 ^{+0.1} _{-0.1}	2.0 ^{+0.1} _{-0.1}

CIRCUITS	W	B0	F	CIRCUITS	W	B0	F
06	44	15.42	20.25	24	56	38.28	26.25
08	44	17.96	20.25	26	56	40.82	26.25
10	44	20.50	20.25	30	72	45.90	34.25
12	44	23.04	20.25	34	72	50.98	34.25
14	44	25.58	20.25	40	72	58.60	34.25
16	44	28.12	20.25	44	88	63.68	42.25
18	44	30.66	20.25	50	88	71.30	42.25
20	56	33.20	26.25				

PULL OUT DIRECTION

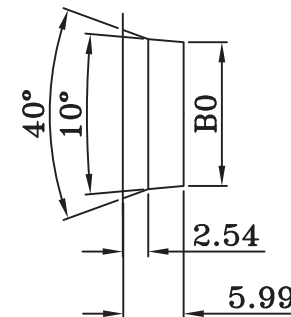
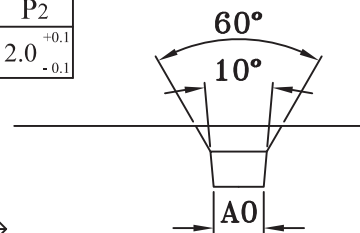
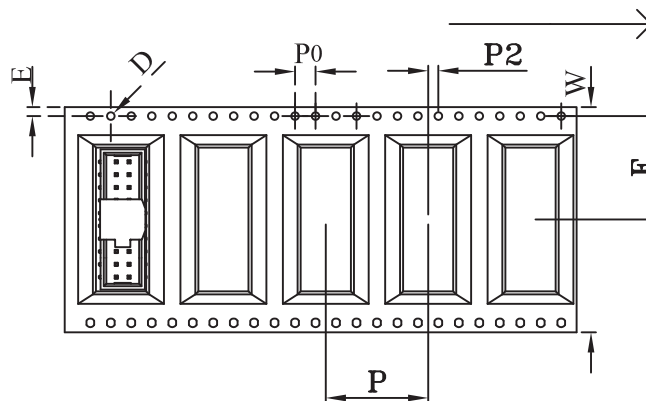
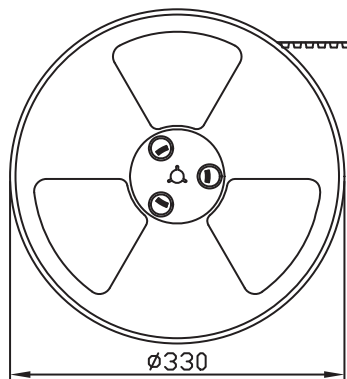

A

B

C

D

RoHS Compliant			
G			
F			
E			
D			
C			
B			
A			
REV	DATE	FILE	BY

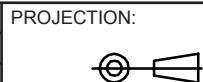

APPROVAL: GMo

GENERAL TOLERANCE

.X = +/- 0.2

.XX = +/- 0.15



UNIT: MM

SCALE:

SHEET: 2/3

DRAW: AS

DESCRIPTION: WR-BHD 2.54MM MALE SMT BOX HEADER

WERI PART NO: 612 3xx 206 21

SIZE

A4

1

2

3

4

5

Cautions and Warnings:

This electronic component is designed and developed with the intention for use in general electronics equipments.



Before incorporating the components into any equipments in the field such as aerospace, aviation, nuclear control, submarine, transportation, (automotive control, train control, ship control), transportation signal, disaster prevention, medical, public information network etc. where higher safety and reliability are especially required or if there is possibility of direct damage or injury to human body, Würth Elektronik must be asked for a written approval.

In addition, even electronic component in general electronic equipments, when used in electrical circuits that require high safety, reliability functions or performance, the sufficient reliability evaluation-check for the safety must be performed before by the user before usage.

A

B

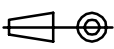
C

RoHS Compliant				PROJECTION: 	GENERAL TOLERANCE .X = +/- 0.2 .XX = +/- 0.15	 WÜRTH ELEKTRONIK	DESCRIPTION: DISCLAIMER	SIZE A4
G								
F								
E								
D								
C				APPROVAL: JC	UNIT: MM	WERI PART NO: DISCLAIMER	SIZE A4	
B				SCALE:				
A	10-SEP-14	PDF	QL	SHEET: 3/3				
REV	DATE	FILE	BY	DRAW: QL				

D

Данный компонент на территории Российской Федерации

Вы можете приобрести в компании MosChip.

Для оперативного оформления запроса Вам необходимо перейти по данной ссылке:

<http://moschip.ru/get-element>

Вы можете разместить у нас заказ для любого Вашего проекта, будь то серийное производство или разработка единичного прибора.

В нашем ассортименте представлены ведущие мировые производители активных и пассивных электронных компонентов.

Нашей специализацией является поставка электронной компонентной базы двойного назначения, продукции таких производителей как XILINX, Intel (ex.ALTERA), Vicor, Microchip, Texas Instruments, Analog Devices, Mini-Circuits, Amphenol, Glenair.

Сотрудничество с глобальными дистрибьюторами электронных компонентов, предоставляет возможность заказывать и получать с международных складов практически любой перечень компонентов в оптимальные для Вас сроки.

На всех этапах разработки и производства наши партнеры могут получить квалифицированную поддержку опытных инженеров.

Система менеджмента качества компании отвечает требованиям в соответствии с ГОСТ Р ИСО 9001, ГОСТ РВ 0015-002 и ЭС РД 009

Офис по работе с юридическими лицами:

105318, г.Москва, ул.Щербаковская д.3, офис 1107, 1118, ДЦ «Щербаковский»

Телефон: +7 495 668-12-70 (многоканальный)

Факс: +7 495 668-12-70 (доб.304)

E-mail: info@moschip.ru

Skype отдела продаж:

moschip.ru

moschip.ru_4

moschip.ru_6

moschip.ru_9