



# MICROCHIP MCP4801/4811/4821

## 8/10/12-Bit Voltage Output Digital-to-Analog Converter with Internal $V_{REF}$ and SPI Interface

### Features

- MCP4801: 8-Bit Voltage Output DAC
- MCP4811: 10-Bit Voltage Output DAC
- MCP4821: 12-Bit Voltage Output DAC
- Rail-to-Rail Output
- SPI Interface with 20 MHz Clock Support
- Simultaneous Latching of the DAC Output with LDAC Pin
- Fast Settling Time of 4.5  $\mu$ s
- Selectable Unity or 2x Gain Output
- 2.048V Internal Voltage Reference
- 50 ppm/ $^{\circ}$ C  $V_{REF}$  Temperature Coefficient
- 2.7V to 5.5V Single-Supply Operation
- Extended Temperature Range:  $-40^{\circ}$ C to  $+125^{\circ}$ C

### Applications

- Set Point or Offset Trimming
- Sensor Calibration
- Precision Selectable Voltage Reference
- Portable Instrumentation (Battery-Powered)
- Calibration of Optical Communication Devices

### Related Products<sup>(1)</sup>

P/N	DAC Resolution	No. of Channel	Voltage Reference ( $V_{REF}$ )
MCP4801	8	1	Internal (2.048V)
MCP4811	10	1	
MCP4821	12	1	
MCP4802	8	2	
MCP4812	10	2	
MCP4822	12	2	External
MCP4901	8	1	
MCP4911	10	1	
MCP4921	12	1	
MCP4902	8	2	
MCP4912	10	2	
MCP4922	12	2	

**Note 1:** The products listed here have similar AC/DC performances.

### Description

The MCP4801/4811/4821 devices are single channel 8-bit, 10-bit and 12-bit buffered voltage output Digital-to-Analog Converters (DACs), respectively. The devices operate from a single 2.7V to 5.5V supply with an SPI compatible Serial Peripheral Interface.

The devices have a high precision internal voltage reference ( $V_{REF} = 2.048V$ ). The user can configure the full-scale range of the device to be 2.048V or 4.096V by setting the Gain Selection Option bit (gain of 1 of 2).

The devices can be operated in Active or Shutdown mode by setting a Configuration register bit or using the SHDN pin. In Shutdown mode, most of the internal circuits, including the output amplifier, are turned off for power savings, while the amplifier output ( $V_{OUT}$ ) stage is configured to present a known high resistance output load (500 k $\Omega$ , typical).

The devices include double-buffered registers, allowing a synchronous update of the DAC output using the LDAC pin. These devices also incorporate a Power-on Reset (POR) circuit to ensure reliable power-up.

The devices utilize a resistive string architecture, with its inherent advantages of low DNL error, low ratio metric temperature coefficient and fast settling time. These devices are specified over the extended temperature range ( $+125^{\circ}$ C).

The devices provide high accuracy and low noise performance for consumer and industrial applications where calibration or compensation of signals (such as temperature, pressure and humidity) are required.

The MCP4801/4811/4821 devices are available in the PDIP, SOIC, MSOP and DFN packages.

# MCP4801/4811/4821

## Package Types



## Block Diagram



## 1.0 ELECTRICAL CHARACTERISTICS

### Absolute Maximum Ratings †

$V_{DD}$ .....	6.5V
All inputs and outputs .....	$V_{SS} - 0.3V$ to $V_{DD} + 0.3V$
Current at Input Pins .....	$\pm 2$ mA
Current at Supply Pins .....	$\pm 50$ mA
Current at Output Pins .....	$\pm 25$ mA
Storage temperature .....	$-65^{\circ}C$ to $+150^{\circ}C$
Ambient temp. with power applied .....	$-55^{\circ}C$ to $+125^{\circ}C$
ESD protection on all pins .....	$\geq 4$ kV (HBM), $\geq 400V$ (MM)
Maximum Junction Temperature ( $T_J$ ) .....	$+150^{\circ}C$

† **Notice:** Stresses above those listed under "Maximum Ratings" may cause permanent damage to the device. This is a stress rating only and functional operation of the device at those or any other conditions above those indicated in the operational listings of this specification is not implied. Exposure to maximum rating conditions for extended periods may affect device reliability.

### ELECTRICAL CHARACTERISTICS

Electrical Specifications: Unless otherwise indicated, $V_{DD} = 5V$ , $V_{SS} = 0V$ , $V_{REF} = 2.048V$ , Output Buffer Gain ( $G$ ) = $2x$ , $R_L = 5$ k $\Omega$ to GND, $C_L = 100$ pF, $T_A = -40$ to $+85^{\circ}C$ . Typical values are at $+25^{\circ}C$ .						
Parameters	Sym	Min	Typ	Max	Units	Conditions
<b>Power Requirements</b>						
Operating Voltage	$V_{DD}$	2.7	—	5.5		
Operating Current	$I_{DD}$	—	330	400	$\mu A$	All digital inputs are grounded, analog output ( $V_{OUT}$ ) is unloaded. Code = 000h
Hardware Shutdown Current	$I_{SHDN}$	—	0.3	2	$\mu A$	POR circuit is turned off
Software Shutdown Current	$I_{SHDN\_SW}$	—	3.3	6	$\mu A$	POR circuit remains turned on
Power-on Reset Threshold	$V_{POR}$	—	2.0	—	V	
<b>DC Accuracy</b>						
<b>MCP4801</b>						
Resolution	n	8	—	—	Bits	
INL Error	INL	-1	$\pm 0.125$	1	LSb	
DNL	DNL	-0.5	$\pm 0.1$	+0.5	LSb	<b>Note 1</b>
<b>MCP4811</b>						
Resolution	n	10	—	—	Bits	
INL Error	INL	-3.5	$\pm 0.5$	3.5	LSb	
DNL	DNL	-0.5	$\pm 0.1$	+0.5	LSb	<b>Note 1</b>
<b>MCP4821</b>						
Resolution	n	12	—	—	Bits	
INL Error	INL	-12	$\pm 2$	12	LSb	
DNL	DNL	-0.75	$\pm 0.2$	+0.75	LSb	<b>Note 1</b>
Offset Error	$V_{OS}$	-1	$\pm 0.02$	1	% of FSR	Code = 0x000h
Offset Error Temperature Coefficient	$V_{OS}/^{\circ}C$	—	0.16	—	ppm/ $^{\circ}C$	$-45^{\circ}C$ to $+25^{\circ}C$
		—	-0.44	—	ppm/ $^{\circ}C$	$+25^{\circ}C$ to $+85^{\circ}C$
Gain Error	$g_E$	-2	-0.10	2	% of FSR	Code = 0xFFFFh, not including offset error
Gain Error Temperature Coefficient	$\Delta G/^{\circ}C$	—	-3	—	ppm/ $^{\circ}C$	

**Note 1:** Guaranteed monotonic by design over all codes.

**2:** This parameter is ensured by design, and not 100% tested.

# MCP4801/4811/4821

## ELECTRICAL CHARACTERISTICS (CONTINUED)

Electrical Specifications: Unless otherwise indicated, $V_{DD} = 5V$ , $V_{SS} = 0V$ , $V_{REF} = 2.048V$ , Output Buffer Gain (G) = 2x, $R_L = 5\text{ k}\Omega$ to GND, $C_L = 100\text{ pF}$ , $T_A = -40$ to $+85^\circ\text{C}$ . Typical values are at $+25^\circ\text{C}$ .						
Parameters	Sym	Min	Typ	Max	Units	Conditions
<b>Internal Voltage Reference (<math>V_{REF}</math>)</b>						
Internal Reference Voltage	$V_{REF}$	2.008	2.048	2.088	V	$V_{OUT}$ when G = 1x and Code = 0xFFFFh
Temperature Coefficient (Note 2)	$\Delta V_{REF}/^\circ\text{C}$	—	125	325	ppm/ $^\circ\text{C}$	$-40^\circ\text{C}$ to $0^\circ\text{C}$
		—	0.25	0.65	LSb/ $^\circ\text{C}$	$-40^\circ\text{C}$ to $0^\circ\text{C}$
		—	45	160	ppm/ $^\circ\text{C}$	$0^\circ\text{C}$ to $+85^\circ\text{C}$
		—	0.09	0.32	LSb/ $^\circ\text{C}$	$0^\circ\text{C}$ to $+85^\circ\text{C}$
Output Noise ( $V_{REF}$ Noise)	$E_{NREF}$ (0.1-10 Hz)	—	290	—	$\mu\text{V}_{p-p}$	Code = 0xFFFFh, G = 1x
Output Noise Density	$e_{NREF}$ (1 kHz)	—	1.2	—	$\mu\text{V}/\sqrt{\text{Hz}}$	Code = 0xFFFFh, G = 1x
	$e_{NREF}$ (10 kHz)	—	1.0	—	$\mu\text{V}/\sqrt{\text{Hz}}$	Code = 0xFFFFh, G = 1x
1/f Corner Frequency	$f_{CORNER}$	—	400	—	Hz	
<b>Output Amplifier</b>						
Output Swing	$V_{OUT}$	—	0.01 to $V_{DD}-0.04$	—	V	Accuracy is better than 1 LSb for $V_{OUT} = 10\text{ mV}$ to $(V_{DD} - 40\text{ mV})$
Phase Margin	PM	—	66	—	Degree ( $^\circ$ )	$C_L = 400\text{ pF}$ , $R_L = \infty$
Slew Rate	SR	—	0.55	—	V/ $\mu\text{s}$	
Short Circuit Current	$I_{SC}$	—	15	24	mA	
Settling Time	$t_{SETTLING}$	—	4.5	—	$\mu\text{s}$	Within $\frac{1}{2}$ LSb of final value from $\frac{1}{4}$ to $\frac{3}{4}$ full-scale range
<b>Dynamic Performance (Note 2)</b>						
Major Code Transition Glitch		—	45	—	nV-s	1 LSb change around major carry (0111...1111 to 1000...0000)
Digital Feedthrough		—	<10	—	nV-s	

- Note 1:** Guaranteed monotonic by design over all codes.  
**Note 2:** This parameter is ensured by design, and not 100% tested.

## ELECTRICAL CHARACTERISTIC WITH EXTENDED TEMPERATURE

**Electrical Specifications:** Unless otherwise indicated,  $V_{DD} = 5V$ ,  $V_{SS} = 0V$ ,  $V_{REF} = 2.048V$ , Output Buffer Gain (G) = 2x,  $R_L = 5\text{ k}\Omega$  to GND,  $C_L = 100\text{ pF}$ . Typical values are at +125°C by characterization or simulation.

Parameters	Sym	Min	Typ	Max	Units	Conditions
<b>Power Requirements</b>						
Operating Voltage	$V_{DD}$	2.7	—	5.5		
Operating Current	$I_{DD}$	—	350	—	$\mu A$	All digital inputs are grounded, analog output ( $V_{OUT}$ ) is unloaded. Code = 000h
Hardware Shutdown Current	$I_{SHDN}$	—	1.5	—	$\mu A$	POR circuit is turned off
Software Shutdown Current	$I_{SHDN\_SW}$	—	5	—	$\mu A$	POR circuit remains turned on
Power-on Reset threshold	$V_{POR}$	—	1.85	—	V	
<b>DC Accuracy</b>						
<b>MCP4801</b>						
Resolution	n	8	—	—	Bits	
INL Error	INL	—	$\pm 0.25$	—	LSb	
DNL	DNL	—	$\pm 0.2$	—	LSb	<b>Note 1</b>
<b>MCP4811</b>						
Resolution	n	10	—	—	Bits	
INL Error	INL	—	$\pm 1$	—	LSb	
DNL	DNL	—	$\pm 0.2$	—	LSb	<b>Note 1</b>
<b>MCP4821</b>						
Resolution	n	12	—	—	Bits	
INL Error	INL	—	$\pm 4$	—	LSb	
DNL	DNL	—	$\pm 0.25$	—	LSb	<b>Note 1</b>
Offset Error	$V_{OS}$	—	$\pm 0.02$	—	% of FSR	Code = 0x000h
Offset Error Temperature Coefficient	$V_{OS}/^{\circ}C$	—	-5	—	ppm/ $^{\circ}C$	+25 $^{\circ}C$ to +125 $^{\circ}C$
Gain Error	$g_E$	—	-0.10	—	% of FSR	Code = 0xFFFFh, not including offset error
Gain Error Temperature Coefficient	$\Delta G/^{\circ}C$	—	-3	—	ppm/ $^{\circ}C$	
<b>Internal Voltage Reference (<math>V_{REF}</math>)</b>						
Internal Reference Voltage	$V_{REF}$	—	2.048	—	V	$V_{OUT}$ when G = 1x and Code = 0xFFFFh
Temperature Coefficient ( <b>Note 2</b> )	$\Delta V_{REF}/^{\circ}C$	—	125	—	ppm/ $^{\circ}C$	-40 $^{\circ}C$ to 0 $^{\circ}C$
		—	0.25	—	LSb/ $^{\circ}C$	-40 $^{\circ}C$ to 0 $^{\circ}C$
		—	45	—	ppm/ $^{\circ}C$	0 $^{\circ}C$ to +85 $^{\circ}C$
		—	0.09	—	LSb/ $^{\circ}C$	0 $^{\circ}C$ to +85 $^{\circ}C$
Output Noise ( $V_{REF}$ Noise)	$E_{NREF}$ (0.1 – 10 Hz)	—	290	—	$\mu V_{p-p}$	Code = 0xFFFFh, G = 1x
Output Noise Density	$e_{NREF}$ (1 kHz)	—	1.2	—	$\mu V/\sqrt{Hz}$	Code = 0xFFFFh, G = 1x
	$e_{NREF}$ (10 kHz)	—	1.0	—	$\mu V/\sqrt{Hz}$	Code = 0xFFFFh, G = 1x
1/f Corner Frequency	$f_{CORNER}$	—	400	—	Hz	

**Note 1:** Guaranteed monotonic by design over all codes.

**2:** This parameter is ensured by design, and not 100% tested.

# MCP4801/4811/4821

## ELECTRICAL CHARACTERISTIC WITH EXTENDED TEMPERATURE (CONTINUED)

**Electrical Specifications:** Unless otherwise indicated,  $V_{DD} = 5V$ ,  $V_{SS} = 0V$ ,  $V_{REF} = 2.048V$ , Output Buffer Gain (G) = 2x,  $R_L = 5\text{ k}\Omega$  to GND,  $C_L = 100\text{ pF}$ . Typical values are at +125°C by characterization or simulation.

Parameters	Sym	Min	Typ	Max	Units	Conditions
<b>Output Amplifier</b>						
Output Swing	$V_{OUT}$	—	0.01 to $V_{DD} - 0.04$	—	V	Accuracy is better than 1 LSb for $V_{OUT} = 10\text{ mV}$ to $(V_{DD} - 40\text{ mV})$
Phase Margin	PM	—	66	—	Degree (°)	$C_L = 400\text{ pF}$ , $R_L = \infty$
Slew Rate	SR	—	0.55	—	V/ $\mu\text{s}$	
Short Circuit Current	$I_{SC}$	—	17	—	mA	
Settling Time	$t_{SETTLING}$	—	4.5	—	$\mu\text{s}$	Within $\frac{1}{2}$ LSb of final value from $\frac{1}{4}$ to $\frac{3}{4}$ full-scale range
<b>Dynamic Performance (Note 2)</b>						
Major Code Transition Glitch		—	45	—	nV-s	1 LSb change around major carry (0111...1111 to 1000...0000)
Digital Feedthrough		—	<10	—	nV-s	

- Note 1:** Guaranteed monotonic by design over all codes.  
**Note 2:** This parameter is ensured by design, and not 100% tested.

## AC CHARACTERISTICS (SPI TIMING SPECIFICATIONS)

**Electrical Specifications:** Unless otherwise indicated,  $V_{DD} = 2.7V - 5.5V$ ,  $T_A = -40$  to +125°C. Typical values are at +25°C.

Parameters	Sym	Min	Typ	Max	Units	Conditions
Schmitt Trigger High-Level Input Voltage (All digital input pins)	$V_{IH}$	0.7 $V_{DD}$	—	—	V	
Schmitt Trigger Low-Level Input Voltage (All digital input pins)	$V_{IL}$	—	—	0.2 $V_{DD}$	V	
Hysteresis of Schmitt Trigger Inputs	$V_{HYS}$	—	0.05 $V_{DD}$	—		
Input Leakage Current	$I_{LEAKAGE}$	-1	—	1	$\mu\text{A}$	$\overline{SHDN} = \overline{LDAC} = \overline{CS} = \overline{SDI} = \overline{SCK} = V_{DD}$ or $V_{SS}$
Digital Pin Capacitance (All inputs/outputs)	$C_{IN}$ , $C_{OUT}$	—	10	—	pF	$V_{DD} = 5.0V$ , $T_A = +25^\circ\text{C}$ , $f_{CLK} = 1\text{ MHz}$ (Note 1)
Clock Frequency	$F_{CLK}$	—	—	20	MHz	$T_A = +25^\circ\text{C}$ (Note 1)
Clock High Time	$t_{HI}$	15	—	—	ns	Note 1
Clock Low Time	$t_{LO}$	15	—	—	ns	Note 1
$\overline{CS}$ Fall to First Rising CLK Edge	$t_{CSSR}$	40	—	—	ns	Applies only when $\overline{CS}$ falls with CLK high. (Note 1)
Data Input Setup Time	$t_{SU}$	15	—	—	ns	Note 1
Data Input Hold Time	$t_{HD}$	10	—	—	ns	Note 1
SCK Rise to $\overline{CS}$ Rise Hold Time	$t_{CHS}$	15	—	—	ns	Note 1
$\overline{CS}$ High Time	$t_{CSH}$	15	—	—	ns	Note 1
LDAC Pulse Width	$t_{LD}$	100	—	—	ns	Note 1
LDAC Setup Time	$t_{LS}$	40	—	—	ns	Note 1
SCK Idle Time before $\overline{CS}$ Fall	$t_{IDLE}$	40	—	—	ns	Note 1

- Note 1:** This parameter is ensured by design and not 100% tested.



**FIGURE 1-1:** SPI Input Timing Data.

## TEMPERATURE CHARACTERISTICS

**Electrical Specifications:** Unless otherwise indicated,  $V_{DD} = +2.7V$  to  $+5.5V$ ,  $V_{SS} = GND$ .

Parameters	Sym	Min	Typ	Max	Units	Conditions
<b>Temperature Ranges</b>						
Specified Temperature Range	$T_A$	-40	—	+125	°C	
Operating Temperature Range	$T_A$	-40	—	+125	°C	<b>Note 1</b>
Storage Temperature Range	$T_A$	-65	—	+150	°C	
<b>Thermal Package Resistances</b>						
Thermal Resistance, 8L-DFN (2x3)	$\theta_{JA}$	—	68	—	°C/W	
Thermal Resistance, 8L-MSOP	$\theta_{JA}$	—	211	—	°C/W	
Thermal Resistance, 8L-PDIP	$\theta_{JA}$	—	90	—	°C/W	
Thermal Resistance, 8L-SOIC	$\theta_{JA}$	—	150	—	°C/W	

**Note 1:** The MCP4801/4811/4821 devices operate over this extended temperature range, but with reduced performance. Operation in this range must not cause  $T_j$  to exceed the maximum junction temperature of +150°C.

# MCP4801/4811/4821

## 2.0 TYPICAL PERFORMANCE CURVES

**Note:** The graphs and tables provided following this note are a statistical summary based on a limited number of samples and are provided for informational purposes only. The performance characteristics listed herein are not tested or guaranteed. In some graphs or tables, the data presented may be outside the specified operating range (e.g., outside specified power supply range) and therefore outside the warranted range.

**Note:** Unless otherwise indicated,  $T_A = +25^\circ\text{C}$ ,  $V_{DD} = 5\text{V}$ ,  $V_{SS} = 0\text{V}$ ,  $V_{REF} = 2.048\text{V}$ , Gain = 2,  $R_L = 5\text{ k}\Omega$ ,  $C_L = 100\text{ pF}$ .



**FIGURE 2-1:** DNL vs. Code (MCP4821).



**FIGURE 2-4:** INL vs. Code and Temperature (MCP4821).



**FIGURE 2-2:** DNL vs. Code and Temperature (MCP4821).



**FIGURE 2-5:** Absolute INL vs. Temperature (MCP4821).



**FIGURE 2-3:** Absolute DNL vs. Temperature (MCP4821).



**FIGURE 2-6:** INL vs. Code (MCP4821).

**Note:** Single device graph for illustration of 64 code effect.



# MCP4801/4811/4821

**Note:** Unless otherwise indicated,  $T_A = +25^\circ\text{C}$ ,  $V_{DD} = 5\text{V}$ ,  $V_{SS} = 0\text{V}$ ,  $V_{REF} = 2.048\text{V}$ ,  $\text{Gain} = 2$ ,  $R_L = 5\text{ k}\Omega$ ,  $C_L = 100\text{ pF}$ .



**FIGURE 2-7:** DNL vs. Code and Temperature (MCP4811).



**FIGURE 2-10:** INL vs. Code and Temperature (MCP4801).



**FIGURE 2-8:** INL vs. Code and Temperature (MCP4811).



**FIGURE 2-11:** Full-Scale  $V_{OUT}$  vs. Ambient Temperature and  $V_{DD}$ . Gain = 1x.



**FIGURE 2-9:** DNL vs. Code and Temperature (MCP4801).



**FIGURE 2-12:** Full-Scale  $V_{OUT}$  vs. Ambient Temperature and  $V_{DD}$ . Gain = 2x.

# MCP4801/4811/4821

Note: Unless otherwise indicated,  $T_A = +25^\circ\text{C}$ ,  $V_{DD} = 5\text{V}$ ,  $V_{SS} = 0\text{V}$ ,  $V_{REF} = 2.048\text{V}$ , Gain = 2,  $R_L = 5\text{ k}\Omega$ ,  $C_L = 100\text{ pF}$ .

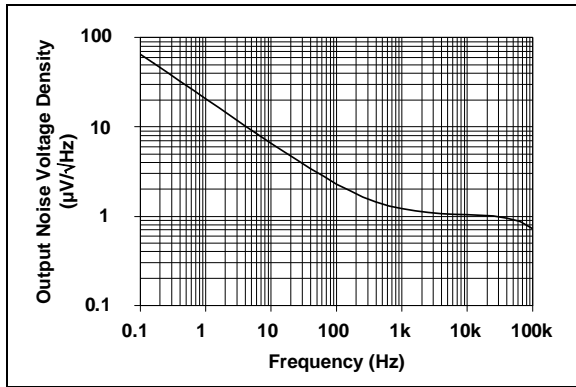

**FIGURE 2-13:** Output Noise Voltage Density ( $V_{REF}$  Noise Density) vs. Frequency. Gain = 1x.



**FIGURE 2-16:**  $I_{DD}$  Histogram ( $V_{DD} = 2.7\text{V}$ ).

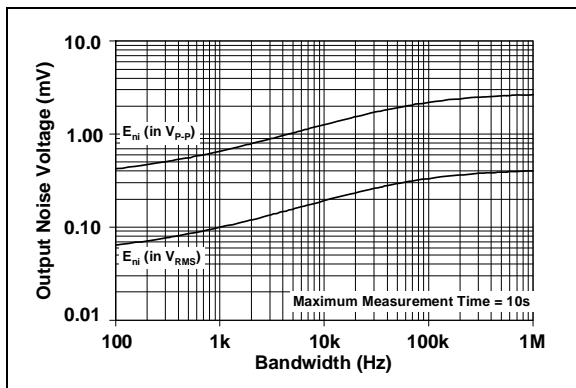

**FIGURE 2-14:** Output Noise Voltage ( $V_{REF}$  Noise Voltage) vs. Bandwidth. Gain = 2x.

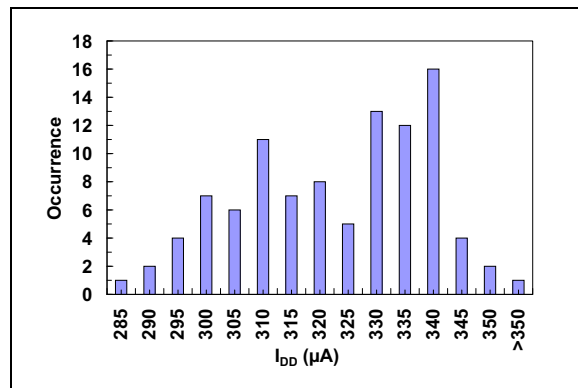

**FIGURE 2-17:**  $I_{DD}$  Histogram ( $V_{DD} = 5.0\text{V}$ ).

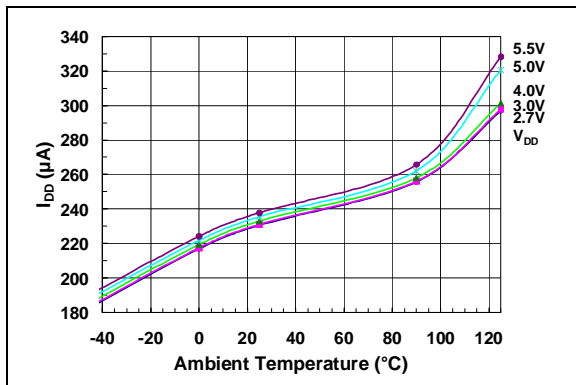

**FIGURE 2-15:**  $I_{DD}$  vs. Temperature and  $V_{DD}$ .

# MCP4801/4811/4821

**Note:** Unless otherwise indicated,  $T_A = +25^\circ\text{C}$ ,  $V_{DD} = 5\text{V}$ ,  $V_{SS} = 0\text{V}$ ,  $V_{REF} = 2.048\text{V}$ ,  $\text{Gain} = 2$ ,  $R_L = 5\text{ k}\Omega$ ,  $C_L = 100\text{ pF}$ .



**FIGURE 2-18:** Hardware Shutdown Current vs. Temperature and  $V_{DD}$ .



**FIGURE 2-21:** Gain Error vs. Temperature and  $V_{DD}$ .



**FIGURE 2-19:** Software Shutdown Current vs. Temperature and  $V_{DD}$ .



**FIGURE 2-22:**  $V_{IN}$  High Threshold vs. Temperature and  $V_{DD}$ .



**FIGURE 2-20:** Offset Error vs. Temperature and  $V_{DD}$ .



**FIGURE 2-23:**  $V_{IN}$  Low Threshold vs. Temperature and  $V_{DD}$ .

# MCP4801/4811/4821

**Note:** Unless otherwise indicated,  $T_A = +25^\circ\text{C}$ ,  $V_{DD} = 5\text{V}$ ,  $V_{SS} = 0\text{V}$ ,  $V_{REF} = 2.048\text{V}$ , Gain = 2,  $R_L = 5\text{ k}\Omega$ ,  $C_L = 100\text{ pF}$ .



**FIGURE 2-24:** *Input Hysteresis vs. Temperature and  $V_{DD}$ .*



**FIGURE 2-27:**  *$I_{OUT}$  High Short vs. Temperature and  $V_{DD}$ .*



**FIGURE 2-25:**  *$V_{OUT}$  High Limit vs. Temperature and  $V_{DD}$ .*



**FIGURE 2-28:**  *$I_{OUT}$  vs.  $V_{OUT}$ . Gain = 2x.*



**FIGURE 2-26:**  *$V_{OUT}$  Low Limit vs. Temperature and  $V_{DD}$ .*

# MCP4801/4811/4821

**Note:** Unless otherwise indicated,  $T_A = +25^\circ\text{C}$ ,  $V_{DD} = 5\text{V}$ ,  $V_{SS} = 0\text{V}$ ,  $V_{REF} = 2.048\text{V}$ , Gain = 2,  $R_L = 5\text{ k}\Omega$ ,  $C_L = 100\text{ pF}$ .



**FIGURE 2-29:**  $V_{OUT}$  Rise Time.



**FIGURE 2-32:**  $V_{OUT}$  Rise Time.



**FIGURE 2-30:**  $V_{OUT}$  Fall Time.



**FIGURE 2-33:**  $V_{OUT}$  Rise Time Exit Shutdown.



**FIGURE 2-31:**  $V_{OUT}$  Rise Time.



**FIGURE 2-34:** PSRR vs. Frequency.

# MCP4801/4811/4821

---

NOTES:

## 3.0 PIN DESCRIPTIONS

The descriptions of the pins are listed in [Table 3-1](#).

**TABLE 3-1: PIN FUNCTION TABLE FOR MCP4801/4811/4821**

MCP4801/4811/4821		Symbol	Description
MSOP, PDIP, SOIC, DFN	DFN		
1	1	$V_{DD}$	Supply Voltage Input (2.7V to 5.5V)
2	2	$\overline{CS}$	Chip Select Input
3	3	SCK	Serial Clock Input
4	4	SDI	Serial Data Input
5	5	$\overline{LDAC}$	DAC Output Synchronization Input. This pin is used to transfer the input register (DAC settings) to the output register ( $V_{OUT}$ )
6	6	$\overline{SHDN}$	Hardware Shutdown Input
7	7	$V_{SS}$	Ground reference point for all circuitry on the device
8	8	$V_{OUT}$	DAC Analog Output
—	9	EP	Exposed thermal pad. This pad must be connected to $V_{SS}$ in application

### 3.1 Supply Voltage Pins ( $V_{DD}$ , $V_{SS}$ )

$V_{DD}$  is the positive supply voltage input pin. The input supply voltage is relative to  $V_{SS}$  and can range from 2.7V to 5.5V. The power supply at the  $V_{DD}$  pin should be as clean as possible for good DAC performance. Using an appropriate bypass capacitor of about 0.1  $\mu$ F (ceramic) to ground is recommended. An additional 10  $\mu$ F capacitor (tantalum) in parallel is also recommended to further attenuate high-frequency noise present in application boards.

$V_{SS}$  is the analog ground pin and the current return path of the device. The user must connect the  $V_{SS}$  pin to a ground plane through a low-impedance connection. If an analog ground path is available in the application Printed Circuit Board (PCB), it is highly recommended that the  $V_{SS}$  pin be tied to the analog ground path or isolated within an analog ground plane of the circuit board.

### 3.2 Chip Select ( $\overline{CS}$ )

$\overline{CS}$  is the Chip Select input pin, which requires an active low to enable serial clock and data functions.

### 3.3 Serial Clock Input (SCK)

SCK is the SPI compatible serial clock input pin.

### 3.4 Serial Data Input (SDI)

SDI is the SPI compatible serial data input pin.

### 3.5 Latch DAC Input ( $\overline{LDAC}$ )

$\overline{LDAC}$  (latch DAC synchronization input) pin is used to transfer the input latch register to the DAC register (output latches,  $V_{OUT}$ ). When this pin is low,  $V_{OUT}$  is updated with input register content. This pin can be tied to low ( $V_{SS}$ ) if the  $V_{OUT}$  update is desired at the rising edge of the  $\overline{CS}$  pin. This pin can be driven by an external control device such as an MCU I/O pin.

### 3.6 Analog Output ( $V_{OUT}$ )

$V_{OUT}$  is the DAC analog output pin. The DAC output has an output amplifier. The full-scale range of the DAC output is from  $V_{SS}$  to  $G \cdot V_{REF}$ , where G is the gain selection option (1x or 2x). The DAC analog output cannot go higher than the supply voltage ( $V_{DD}$ ).

### 3.7 Exposed Thermal Pad (EP)

There is an internal electrical connection between the exposed thermal pad (EP) and the  $V_{SS}$  pin. They must be connected to the same potential on the PCB.

# MCP4801/4811/4821

---

NOTES:



## 4.0 GENERAL OVERVIEW

The MCP4801, MCP4811 and MCP4821 are single channel voltage-output 8-bit, 10-bit and 12-bit DAC devices, respectively. These devices include rail-to-rail output amplifier, internal voltage reference, shutdown and reset-management circuitry. The devices use an SPI serial communication interface and operate with a single supply voltage from 2.7V to 5.5V.

The DAC input coding of these devices is straight binary. Equation 4-1 shows the DAC analog output voltage calculation.

### EQUATION 4-1: ANALOG OUTPUT VOLTAGE ( $V_{OUT}$ )

$$V_{OUT} = \frac{(2.048V \times D_n)}{2^n} \times G$$

Where:

- 2.048V = Internal voltage reference
- $D_n$  = DAC input code
- G = Gain selection
  - = 2 for  $\overline{GA}$  bit = 0
  - = 1 for  $\overline{GA}$  bit = 1
- n = DAC Resolution
  - = 8 for MCP4801
  - = 10 for MCP4811
  - = 12 for MCP4821

The ideal output range of each device is:

- **MCP4801 (n = 8)**
  - (a) 0.0V to  $255/256 * 2.048V$  when gain setting = 1x.
  - (b) 0.0V to  $255/256 * 4.096V$  when gain setting = 2x.
- **MCP4811 (n = 10)**
  - (a) 0.0V to  $1023/1024 * 2.048V$  when gain setting = 1x.
  - (b) 0.0V to  $1023/1024 * 4.096V$  when gain setting = 2x.
- **MCP4821 (n = 12)**
  - (a) 0.0V to  $4095/4096 * 2.048V$  when gain setting = 1x.
  - (b) 0.0V to  $4095/4096 * 4.096V$  when gain setting = 2x.

**Note:** See the output swing voltage specification in Section 1.0 "Electrical Characteristics".

1 LSB is the ideal voltage difference between two successive codes. Table 4-1 illustrates the LSB calculation of each device.

TABLE 4-1: LSB OF EACH DEVICE

Device	Gain Selection	LSb Size
MCP4801 (n = 8)	1x	$2.048V/256 = 8 \text{ mV}$
	2x	$4.096V/256 = 16 \text{ mV}$
MCP4811 (n = 10)	1x	$2.048V/1024 = 2 \text{ mV}$
	2x	$4.096V/1024 = 4 \text{ mV}$
MCP4821 (n = 12)	1x	$2.048V/4096 = 0.5 \text{ mV}$
	2x	$4.096V/4096 = 1 \text{ mV}$

### 4.0.1 INL ACCURACY

Integral Non-Linearity (INL) error is the maximum deviation between an actual code transition point and its corresponding ideal transition point once offset and gain errors have been removed. The two endpoints method (from 0x000 to 0xFFFF) is used for the calculation. Figure 4-1 shows the details.

A positive INL error represents transition(s) later than ideal. A negative INL error represents transition(s) earlier than ideal.



FIGURE 4-1: Example for INL Error.

# MCP4801/4811/4821

## 4.0.2 DNL ACCURACY

A Differential Non-Linearity (DNL) error is the measure of the variations in code widths from the ideal code width. A DNL error of zero indicates that every code is exactly 1 LSb wide.



**FIGURE 4-2:** Example for DNL Error.

## 4.0.3 OFFSET ERROR

Offset error is the deviation from zero voltage output when the digital input code is zero.

## 4.0.4 GAIN ERROR

Gain error is the deviation from the ideal output,  $V_{REF} - 1 \text{ LSb}$ , excluding the effects of offset error.

## 4.1 Circuit Descriptions

### 4.1.1 OUTPUT AMPLIFIER

The analog DAC output is buffered with a low-power, precision CMOS amplifier. This amplifier provides low offset voltage and low noise. The output stage enables the device to operate with output voltages close to the power supply rails. Refer to **Section 1.0 “Electrical Characteristics”** for the analog output voltage range and load conditions.

In addition to resistive load-driving capability, the amplifier will also drive high capacitive loads without oscillation. The amplifier’s strong output allows  $V_{OUT}$  to be used as a programmable voltage reference in a system.

#### 4.1.1.1 Programmable Gain Block

The rail-to-rail output amplifier has two configurable gain options: a gain of 1x ( $\langle GA \rangle = 1$ ) or a gain of 2x ( $\langle GA \rangle = 0$ ). The default setting is a gain of 2x. This results in an ideal full-scale output of 0.000V to 4.096V due to the internal reference ( $V_{REF} = 2.048\text{V}$ ).

### 4.1.2 VOLTAGE REFERENCE

The MCP4801/4811/4821 devices utilize internal 2.048V voltage reference. The voltage reference has a low temperature coefficient and low noise characteristics. Refer to **Section 1.0 “Electrical Characteristics”** for the voltage reference specifications.

## 4.1.3 POWER-ON RESET CIRCUIT

The internal Power-on Reset (POR) circuit monitors the power supply voltage ( $V_{DD}$ ) during the device operation. The circuit also ensures that the DAC powers up with high output impedance ( $\overline{\text{SHDN}} = 0$ , typically 500 k $\Omega$ ). The devices will continue to have a high-impedance output until a valid write command is received, and the  $\overline{\text{LDAC}}$  pin meets the input low threshold.

If the power supply voltage is less than the POR threshold ( $V_{POR} = 2.0\text{V}$ , typical), the DAC will be held in the Reset state. It will remain in that state until  $V_{DD} > V_{POR}$  and a subsequent write command is received.

Figure 4-3 shows a typical power supply transient pulse and the duration required to cause a reset to occur, as well as the relationship between the duration and trip voltage. A 0.1  $\mu\text{F}$  decoupling capacitor, mounted as close as possible to the  $V_{DD}$  pin, can provide additional transient immunity.



FIGURE 4-3: Typical Transient Response.

## 4.1.4 SHUTDOWN MODE

The user can shut down the device using a software command ( $\overline{\text{SHDN}} = 0$ ) or  $\overline{\text{SHDN}}$  pin. During shutdown mode, most of the internal circuits, including the output amplifier, are turned off for power savings. The internal reference is not affected by the shutdown command. The serial interface also remains active, allowing a write command to bring the device out of Shutdown mode. There will be no analog output at the  $V_{OUT}$  pin, which is internally switched to a known resistive load (500 k $\Omega$ , typical). Figure 4-4 shows the analog output stage during Shutdown mode.

The condition of the Power-on Reset circuit during Shutdown is as follows:

- Turned off if shutdown occurred from the  $\overline{\text{SHDN}}$  pin
- Remains turned on if the shutdown occurred through software

The device will remain in Shutdown mode until the  $\overline{\text{SHDN}}$  bit = 1 is latched into the device or  $\overline{\text{SHDN}}$  pin is changed to logic high. When the device is changed from Shutdown to Active mode, the output settling time takes  $< 10 \mu\text{s}$ , but greater than the standard active mode settling time (4.5  $\mu\text{s}$ ).



FIGURE 4-4: Output Stage for Shutdown Mode.

# MCP4801/4811/4821

---

NOTES:

## 5.0 SERIAL INTERFACE

### 5.1 Overview

The MCP4801/4811/4821 devices are designed to interface directly with the Serial Peripheral Interface (SPI) port, available on many microcontrollers, and supports Mode 0,0 and Mode 1,1. Commands and data are sent to the device via the SDI pin, with data being clocked-in on the rising edge of SCK. The communications are unidirectional and, thus, data cannot be read out of the MCP4801/4811/4821 devices. The  $\overline{CS}$  pin must be held low for the duration of a write command. The write command consists of 16 bits and is used to configure the DAC's control and data latches. [Register 5-1](#) to [Register 5-3](#) detail the input register that is used to configure and load the DAC register for each device. [Figure 5-1](#) to [Figure 5-3](#) show the write command for each device.

Refer to [Figure 1-1](#) and the SPI Timing Specifications Table for detailed input and output timing specifications for both Mode 0,0 and Mode 1,1 operation.

### 5.2 Write Command

The write command is initiated by driving the  $\overline{CS}$  pin low, followed by clocking the four Configuration bits and the 12 data bits into the SDI pin on the rising edge of SCK. The  $\overline{CS}$  pin is then raised, causing the data to be latched into the DAC's input register.

The MCP4801/4811/4821 devices utilize a double-buffered latch structure to allow the DAC output to be synchronized with the  $\overline{LDAC}$  pin, if desired.

By bringing down the  $\overline{LDAC}$  pin to a low state, the content stored in the DAC's input register is transferred into the DAC's output register ( $V_{OUT}$ ), and  $V_{OUT}$  is updated.

All writes to the MCP4801/4811/4821 devices are 16-bit words. Any clocks after the first 16<sup>th</sup> clock will be ignored. The Most Significant four bits are Configuration bits. The remaining 12 bits are data bits. No data can be transferred into the device with  $\overline{CS}$  high. The data transfer will only occur if 16 clocks have been transferred into the device. If the rising edge of  $\overline{CS}$  occurs prior, shifting of data into the input register will be aborted.

# MCP4801/4811/4821

## REGISTER 5-1: WRITE COMMAND REGISTER FOR MCP4821 (12-BIT DAC)

W-x	W-x	W-x	W-0	W-x	W-x	W-x	W-x	W-x	W-x	W-x	W-x	W-x	W-x	W-x	W-x
0	—	$\overline{GA}$	$\overline{SHDN}$	D11	D10	D9	D8	D7	D6	D5	D4	D3	D2	D1	D0
bit 15								bit 0							

## REGISTER 5-2: WRITE COMMAND REGISTER FOR MCP4811 (10-BIT DAC)

W-x	W-x	W-x	W-0	W-x	W-x	W-x	W-x	W-x	W-x	W-x	W-x	W-x	W-x	W-x	W-x
0	—	$\overline{GA}$	$\overline{SHDN}$	D9	D8	D7	D6	D5	D4	D3	D2	D1	D0	x	x
bit 15								bit 0							

## REGISTER 5-3: WRITE COMMAND REGISTER FOR MCP4801 (8-BIT DAC)

W-x	W-x	W-x	W-0	W-x	W-x	W-x	W-x	W-x	W-x	W-x	W-x	W-x	W-x	W-x	W-x
0	—	$\overline{GA}$	$\overline{SHDN}$	D7	D6	D5	D4	D3	D2	D1	D0	x	x	x	x
bit 15								bit 0							

Where:

bit 15 (<sup>1</sup>) 0 = Write to DAC register  
1 = Ignore this command

bit 14 — Don't Care

bit 13  $\overline{GA}$ : Output Gain Selection bit

1 =  $1x (V_{OUT} = V_{REF} * D/4096)$

0 =  $2x (V_{OUT} = 2 * V_{REF} * D/4096)$ , where internal  $V_{REF} = 2.048V$ .

bit 12  $\overline{SHDN}$ : Output Shutdown Control bit

1 = Active mode operation.  $V_{OUT}$  is available.

0 = Shutdown the device. Analog output is not available.  $V_{OUT}$  pin is connected to 500 k $\Omega$  (typical).

bit 11-0 **D11:D0**: DAC Input Data bits. Bit x is ignored.

### Legend

R = Readable bit

W = Writable bit

U = Unimplemented bit, read as '0'

-n = Value at POR

1 = bit is set

0 = bit is cleared

x = bit is unknown

**Note 1:** This bit must be '0'. The device ignores the write command if this MSB bit is not '0'.

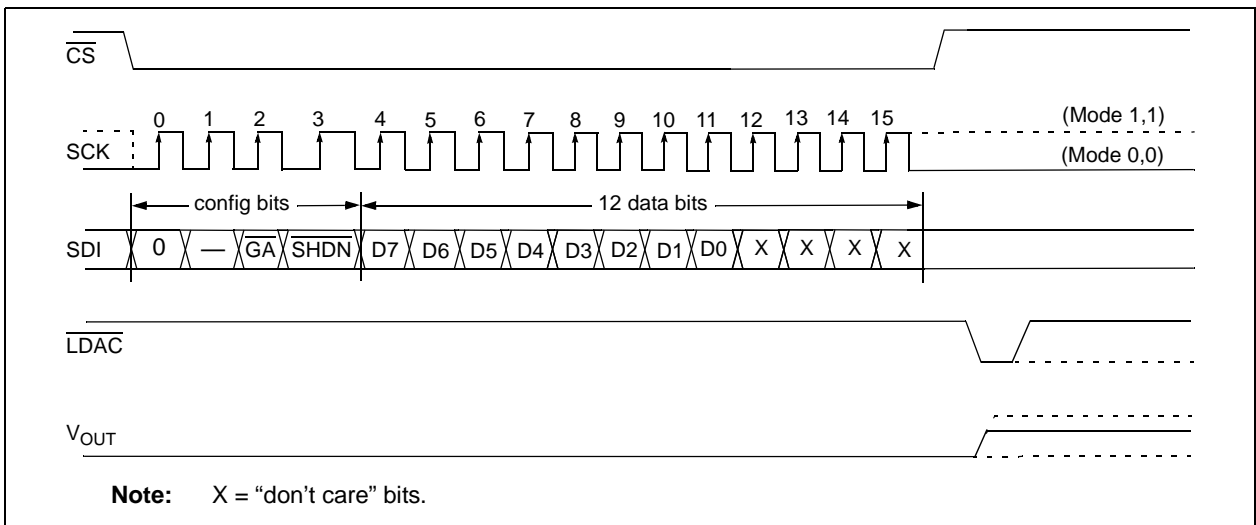

**FIGURE 5-1:** Write Command for MCP4821 (12-bit DAC).



**Note:** X = "don't care" bits.

**FIGURE 5-2:** Write Command for MCP4811 (10-bit DAC).



**Note:** X = "don't care" bits.

**FIGURE 5-3:** Write Command for MCP4801 (8-bit DAC).

# MCP4801/4811/4821

---

NOTES:



## 6.0 TYPICAL APPLICATIONS

The MCP4801/4811/4821 family of devices are general purpose, single channel voltage output DACs for various applications where a precision operation with low-power and internal voltage reference is required.

Applications generally suited for the devices are:

- Set Point or Offset Trimming
- Sensor Calibration
- Precision Selectable Voltage Reference
- Portable Instrumentation (Battery-Powered)
- Calibration of Optical Communication Devices

### 6.1 Digital Interface

The MCP4801/4811/4821 devices utilize a 3-wire synchronous serial protocol to transfer the DAC's setup and input codes from the digital devices. The serial protocol can be interfaced to SPI or Microwire peripherals which are common on many microcontroller units (MCUs), including Microchip's PIC® MCUs and dsPIC® DSCs.

In addition to the three serial connections ( $\overline{CS}$ , SCK and SDI), the  $\overline{LDAC}$  signal synchronizes the DAC output with  $\overline{LDAC}$  pin event. By bringing the  $\overline{LDAC}$  pin down "low", the DAC input codes and settings in the DAC input register are latched into the output register, and the DAC analog output is updated. Figure 6-1 shows an example of the pin connections. Note that the  $\overline{LDAC}$  pin can be tied low ( $V_{SS}$ ) to reduce the required connections from 4 to 3 I/O pins. In this case, the DAC output can be immediately updated when a valid 16 clock transmission has been received and the  $\overline{CS}$  pin has been raised.

### 6.2 Power Supply Considerations

The typical application will require a bypass capacitor to filter out noise in the power supply traces. The noise can be induced onto the power supply's traces from various events such as digital switching or as a result of changes on the DAC's output. The bypass capacitor helps minimize the effect of these noise sources. Figure 6-1 illustrates an appropriate bypass strategy. In this example, two bypass capacitors are used in parallel: (a) 0.1  $\mu\text{F}$  (ceramic) and (b) 10  $\mu\text{F}$  (tantalum). These capacitors should be placed as close to the device power pin ( $V_{DD}$ ) as possible (within 4 mm).

The power source supplying these devices should be as clean as possible. If the application circuit has separate digital and analog power supplies,  $V_{DD}$  and  $V_{SS}$  of the device should reside on the analog plane.

### 6.3 Output Noise Considerations

The voltage noise density (in  $\mu\text{V}/\sqrt{\text{Hz}}$ ) is illustrated in Figure 2-13. This noise appears at  $V_{OUT}$ , and is primarily a result of the internal reference voltage. Its 1/f corner ( $f_{\text{CORNER}}$ ) is approximately 400 Hz.

Figure 2-14 illustrates the voltage noise (in  $\text{mV}_{\text{RMS}}$  or  $\text{mV}_{\text{P-P}}$ ). A small bypass capacitor on  $V_{OUT}$  is an effective method to produce a single-pole Low-Pass Filter (LPF) that will reduce this noise. For instance, a bypass capacitor sized to produce a 1 kHz LPF would result in an  $E_{\text{NREF}}$  of about 100  $\mu\text{V}_{\text{RMS}}$ . This would be necessary when trying to achieve the low DNL error performance (at  $G = 1x$ ) that the MCP4801/4811/4821 devices are capable of. The tested range for stability is .001  $\mu\text{F}$  through 4.7  $\mu\text{F}$ .



FIGURE 6-1: Typical Connection Diagram.

### 6.4 Layout Considerations

Inductively-coupled AC transients and digital switching noises can degrade the output signal integrity, and potentially reduce the device performance. Careful board layout will minimize these effects and increase the Signal-to-Noise Ratio (SNR). Bench testing has shown that a multi-layer board utilizing a low-inductance ground plane, isolated inputs and isolated outputs with proper decoupling, is critical for the best performance. Particularly harsh environments may require shielding of critical signals.

Breadboards and wire-wrapped boards are not recommended if low noise is desired.

# MCP4801/4811/4821

## 6.5 Single-Supply Operation

The MCP4801/4811/4821 devices are rail-to-rail voltage output DAC devices designed to operate with a  $V_{DD}$  range of 2.7V to 5.5V. Its output amplifier is robust enough to drive small-signal loads directly. Therefore, it does not require any external output buffer for most applications.

### 6.5.1 DC SET POINT OR CALIBRATION

A common application for the devices is a digitally-controlled set point and/or calibration of variable parameters, such as sensor offset or slope. For example, the MCP4821 and MCP4822 provide 4096 output steps. If  $G = 1x$  is selected, the internal 2.048V  $V_{REF}$  would produce 500  $\mu V$  of resolution. If  $G = 2x$  is selected, the internal 2.048  $V_{REF}$  would produce 1 mV of resolution.

### 6.5.1.1 Decreasing Output Step Size

If the application is calibrating the bias voltage of a diode or transistor, a bias voltage range of 0.8V may be desired with about 200  $\mu V$  resolution per step. Two common methods to achieve a 0.8V range are to either reduce  $V_{REF}$  to 0.82V (using the MCP49XX family device that uses external reference) or use a voltage divider on the DAC's output.

Using a  $V_{REF}$  is an option if the  $V_{REF}$  is available with the desired output voltage range. However, occasionally, when using a low-voltage  $V_{REF}$  the noise floor causes SNR error that is intolerable. Using a voltage divider method is another option and provides some advantages when  $V_{REF}$  needs to be very low or when the desired output voltage is not available. In this case, a larger value  $V_{REF}$  is used while two resistors scale the output range down to the precise desired level.

**Example 6-1** illustrates this concept. Note that the bypass capacitor on the output of the voltage divider plays a critical function in attenuating the output noise of the DAC and the induced noise from the environment.

### EXAMPLE 6-1: EXAMPLE CIRCUIT OF SET POINT OR THRESHOLD CALIBRATION



## 6.5.1.2 Building a “Window” DAC

When calibrating a set point or threshold of a sensor, typically only a small portion of the DAC output range is utilized. If the LSB size is adequate enough to meet the application’s accuracy needs, the unused range is sacrificed without consequences. If greater accuracy is needed, then the output range will need to be reduced to increase the resolution around the desired threshold.

If the threshold is not near  $V_{REF}$ ,  $2V_{REF}$  or  $V_{SS}$ , then creating a “window” around the threshold has several advantages. One simple method to create this “window” is to use a voltage divider network with a pull-up and pull-down resistor. [Example 6-2](#) and [Example 6-4](#) illustrate this concept.

### EXAMPLE 6-2: SINGLE-SUPPLY “WINDOW” DAC

**(a) Single Output DAC:**

- MCP4801
- MCP4811
- MCP4821

**(b) Dual Output DAC:**

- MCP4802
- MCP4812
- MCP4822



$$V_{OUT} = 2.048 \cdot G \cdot \frac{D_n}{2^N}$$

- G = Gain selection (1x or 2x)
- $D_n$  = Digital value of DAC (0-255) for MCP4801/MCP4802  
= Digital value of DAC (0-1023) for MCP4811/MCP4812  
= Digital value of DAC (0-4095) for MCP4821/MCP4822
- N = DAC bit resolution



# MCP4801/4811/4821

## 6.6 Bipolar Operation

Bipolar operation is achievable using the MCP4801/4811/4821 family of devices by utilizing an external operational amplifier (op amp). This configuration is desirable due to the wide variety and availability of op amps. This allows a general purpose DAC, with its cost and availability advantages, to meet almost any desired output voltage range, power and noise performance.

**Example 6-3** illustrates a simple bipolar voltage source configuration.  $R_1$  and  $R_2$  allow the gain to be selected, while  $R_3$  and  $R_4$  shift the DAC's output to a selected offset. Note that  $R_4$  can be tied to  $V_{DD}$ , instead of  $V_{SS}$ , if a higher offset is desired. Also note that a pull-up to  $V_{DD}$  could be used instead of  $R_4$ , or in addition to  $R_4$ , if a higher offset is desired.

### EXAMPLE 6-3: DIGITALLY-CONTROLLED BIPOLAR VOLTAGE SOURCE

**(a) Single Output DAC:**  
MCP4801  
MCP4811  
MCP4821

**(b) Dual Output DAC:**  
MCP4802  
MCP4812  
MCP4822

$G$  = Gain selection (1x or 2x)  
 $D_n$  = Digital value of DAC (0-255) for MCP4801/MCP4802  
 = Digital value of DAC (0-1023) for MCP4811/MCP4812  
 = Digital value of DAC (0-4095) for MCP4821/MCP4822  
 $N$  = DAC bit resolution

$$V_{OUT} = 2.048 \cdot G \cdot \frac{D_n}{2^N}$$

$$V_{IN+} = \frac{V_{OUT}R_4}{R_3 + R_4}$$

$$V_O = V_{IN+} \left( 1 + \frac{R_2}{R_1} \right) - V_{DD} \left( \frac{R_2}{R_1} \right)$$

#### 6.6.1 DESIGN EXAMPLE: DESIGN A BIPOLAR DAC USING EXAMPLE 6-3 WITH 12-BIT MCP4821 OR MCP4822

An output step magnitude of 1 mV, with an output range of  $\pm 2.05V$ , is desired for a particular application.

**Step 1:** Calculate the range:  $+2.05V - (-2.05V) = 4.1V$ .

**Step 2:** Calculate the resolution needed:

$$4.1V / 1 \text{ mV} = 4100$$

Since  $2^{12} = 4096$ , 12-bit resolution is desired.

**Step 3:** The amplifier gain ( $R_2/R_1$ ), multiplied by full-scale  $V_{OUT}$  (4.096V), must be equal to the desired minimum output to achieve bipolar operation. Since any gain can be realized by choosing resistor values ( $R_1+R_2$ ), the  $V_{REF}$  value must be selected first. If a  $V_{REF}$  of 4.096V is used ( $G=2$ ), solve for the amplifier's gain by setting the DAC to 0, knowing that the output needs to be -2.05V.

The equation can be simplified to:

$$\frac{-R_2}{R_1} = \frac{-2.05}{4.096V} \quad \frac{R_2}{R_1} = \frac{1}{2}$$

If  $R_1 = 20 \text{ k}\Omega$  and  $R_2 = 10 \text{ k}\Omega$ , the gain will be 0.5.

**Step 4:** Next solve for  $R_3$  and  $R_4$  by setting the DAC to 4096, knowing that the output needs to be +2.05V.

$$\frac{R_4}{(R_3 + R_4)} = \frac{2.05V + (0.5 \cdot 4.096V)}{1.5 \cdot 4.096V} = \frac{2}{3}$$

If  $R_4 = 20 \text{ k}\Omega$ , then  $R_3 = 10 \text{ k}\Omega$

## 6.7 Selectable Gain and Offset Bipolar Voltage Output

In some applications, precision digital control of the output range is desirable. [Example 6-4](#) illustrates how to use the MCP4801/4811/4821 family of devices to achieve this in a bipolar or single-supply application.

This circuit is typically used for linearizing a sensor whose slope and offset varies.

The equation to design a bipolar “window” DAC would be utilized if  $R_3$ ,  $R_4$  and  $R_5$  are populated.

### EXAMPLE 6-4: BIPOLAR VOLTAGE SOURCE WITH SELECTABLE GAIN AND OFFSET



# MCP4801/4811/4821

## 6.8 Designing a Double-Precision DAC

Example 6-5 illustrates how to design a single-supply voltage output capable of up to 24-bit resolution by using 12-bit DACs. This design is simply a voltage divider with a buffered output.

As an example, if an application similar to the one developed in Section 6.6.1 “Design Example: Design a Bipolar DAC Using Example 6-3 with 12-bit MCP4821 or MCP4822” required a resolution of 1  $\mu\text{V}$  instead of 1 mV, and a range of 0V to 4.1V, then 12-bit resolution would not be adequate.

**Step 1:** Calculate the resolution needed:

$4.1\text{V}/1\ \mu\text{V} = 4.1 \times 10^6$ . Since  $2^{22} = 4.2 \times 10^6$ , 22-bit resolution is desired. Since  $\text{DNL} = \pm 0.75\ \text{LSb}$ , this design can be done with the 12-bit MCP4821 or MCP4822 DAC devices.

**Step 2:** Since DAC<sub>B</sub>'s  $V_{\text{OUTB}}$  has a resolution of 1 mV, its output only needs to be “pulled” 1/1000 to meet the 1  $\mu\text{V}$  target. Dividing  $V_{\text{OUTA}}$  by 1000 would allow the application to compensate for DAC<sub>B</sub>'s DNL error.

**Step 3:** If  $R_2$  is 100 $\Omega$ , then  $R_1$  needs to be 100 k $\Omega$ .

**Step 4:** The resulting transfer function is shown in the equation of Example 6-5.

### EXAMPLE 6-5: SIMPLE, DOUBLE-PRECISION DAC WITH MCP4821



## 6.9 Building Programmable Current Source

**Example 6-6** shows an example of building a programmable current source using a voltage follower. The current sensor (sensor resistor) is used to convert the DAC voltage output into a digitally-selectable current source.

Adding the resistor network from **Example 6-2** would be advantageous in this application. The smaller  $R_{SENSE}$  is, the less power dissipated across it.

However, this also reduces the resolution that the current can be controlled with. The voltage divider, or “window”, DAC configuration would allow the range to be reduced, thus increasing resolution around the range of interest. When working with very small sensor voltages, plan on eliminating the amplifier’s offset error by storing the DAC’s setting under known sensor conditions.

### EXAMPLE 6-6: DIGITALLY-CONTROLLED CURRENT SOURCE



# MCP4801/4811/4821

---

NOTES:



## 7.0 DEVELOPMENT SUPPORT

### 7.1 Evaluation & Demonstration Boards

The Mixed Signal PICtail™ Demo Board supports the MCP4801/4811/4821 family of devices. Refer to [www.microchip.com](http://www.microchip.com) for further information on this product's capabilities and availability.

# MCP4801/4811/4821

---

NOTES:

## 8.0 PACKAGING INFORMATION

### 8.1 Package Marking Information

8-Lead DFN (2x3)



Example:



8-Lead MSOP



Example:



8-Lead PDIP (300 mil)



Example:



8-Lead SOIC (150 mil)

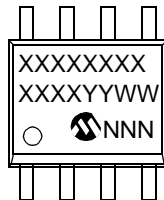

Example:

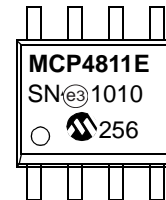

<b>Legend:</b>	XX...X	Customer-specific information
	Y	Year code (last digit of calendar year)
	YY	Year code (last 2 digits of calendar year)
	WW	Week code (week of January 1 is week '01')
	NNN	Alphanumeric traceability code
	(e3)	Pb-free JEDEC designator for Matte Tin (Sn)
	*	This package is Pb-free. The Pb-free JEDEC designator (e3) can be found on the outer packaging for this package.

**Note:** In the event the full Microchip part number cannot be marked on one line, it will be carried over to the next line, thus limiting the number of available characters for customer-specific information.

# MCP4801/4811/4821

## 8-Lead Plastic Dual Flat, No Lead Package (MC) – 2x3x0.9 mm Body [DFN]

**Note:** For the most current package drawings, please see the Microchip Packaging Specification located at <http://www.microchip.com/packaging>

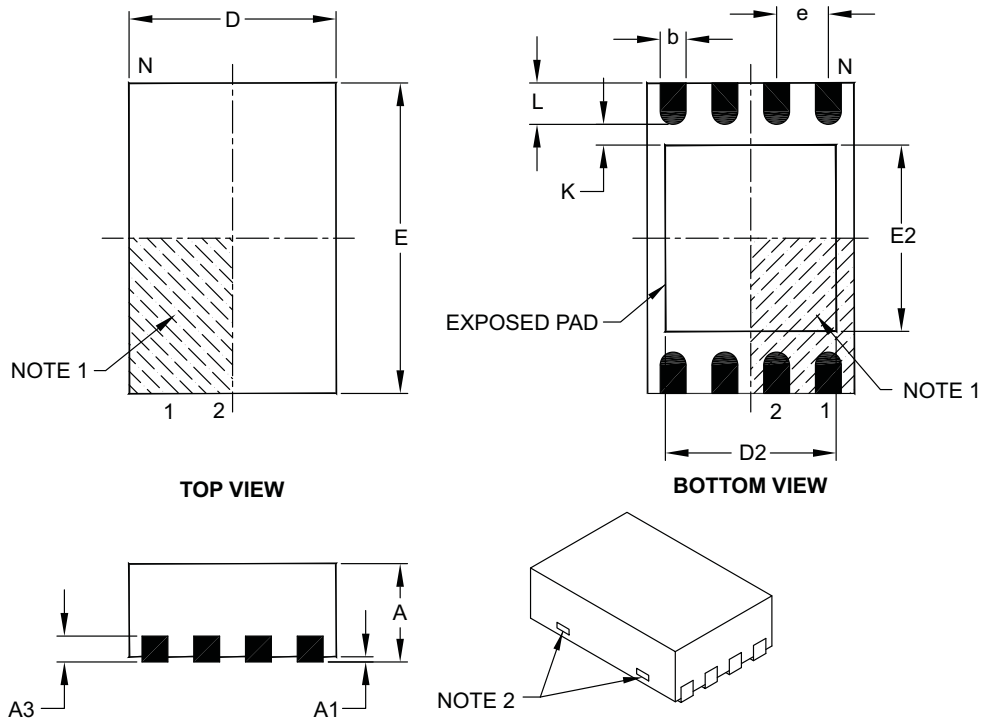

Dimension Limits	Units	MILLIMETERS		
		MIN	NOM	MAX
Number of Pins	N	8		
Pitch	e	0.50 BSC		
Overall Height	A	0.80	0.90	1.00
Standoff	A1	0.00	0.02	0.05
Contact Thickness	A3	0.20 REF		
Overall Length	D	2.00 BSC		
Overall Width	E	3.00 BSC		
Exposed Pad Length	D2	1.30	–	1.55
Exposed Pad Width	E2	1.50	–	1.75
Contact Width	b	0.20	0.25	0.30
Contact Length	L	0.30	0.40	0.50
Contact-to-Exposed Pad	K	0.20	–	–

**Notes:**

- Pin 1 visual index feature may vary, but must be located within the hatched area.
- Package may have one or more exposed tie bars at ends.
- Package is saw singulated.
- Dimensioning and tolerancing per ASME Y14.5M.

BSC: Basic Dimension. Theoretically exact value shown without tolerances.

REF: Reference Dimension, usually without tolerance, for information purposes only.

Microchip Technology Drawing C04-123C

## 8-Lead Plastic Dual Flat, No Lead Package (MC) – 2x3x0.9 mm Body [DFN]

**Note:** For the most current package drawings, please see the Microchip Packaging Specification located at <http://www.microchip.com/packaging>



RECOMMENDED LAND PATTERN

Dimension Limits	Units	MILLIMETERS		
		MIN	NOM	MAX
Contact Pitch	E	0.50 BSC		
Optional Center Pad Width	W2			1.45
Optional Center Pad Length	T2			1.75
Contact Pad Spacing	C1		2.90	
Contact Pad Width (X8)	X1			0.30
Contact Pad Length (X8)	Y1			0.75
Distance Between Pads	G	0.20		

**Notes:**

1. Dimensioning and tolerancing per ASME Y14.5M

BSC: Basic Dimension. Theoretically exact value shown without tolerances.

Microchip Technology Drawing No. C04-2123A

# MCP4801/4811/4821

## 8-Lead Plastic Micro Small Outline Package (MS) [MSOP]

**Note:** For the most current package drawings, please see the Microchip Packaging Specification located at <http://www.microchip.com/packaging>



Dimension Limits	Units	MILLIMETERS		
		MIN	NOM	MAX
Number of Pins	N	8		
Pitch	e	0.65 BSC		
Overall Height	A	–	–	1.10
Molded Package Thickness	A2	0.75	0.85	0.95
Standoff	A1	0.00	–	0.15
Overall Width	E	4.90 BSC		
Molded Package Width	E1	3.00 BSC		
Overall Length	D	3.00 BSC		
Foot Length	L	0.40	0.60	0.80
Footprint	L1	0.95 REF		
Foot Angle	$\phi$	0°	–	8°
Lead Thickness	c	0.08	–	0.23
Lead Width	b	0.22	–	0.40

**Notes:**

- Pin 1 visual index feature may vary, but must be located within the hatched area.
- Dimensions D and E1 do not include mold flash or protrusions. Mold flash or protrusions shall not exceed 0.15 mm per side.
- Dimensioning and tolerancing per ASME Y14.5M.

BSC: Basic Dimension. Theoretically exact value shown without tolerances.

REF: Reference Dimension, usually without tolerance, for information purposes only.

Microchip Technology Drawing C04-111B

## 8-Lead Plastic Micro Small Outline Package (MS) [MSOP]

**Note:** For the most current package drawings, please see the Microchip Packaging Specification located at <http://www.microchip.com/packaging>



RECOMMENDED LAND PATTERN

Dimension Limits	Units	MILLIMETERS		
		MIN	NOM	MAX
Contact Pitch	E	0.65 BSC		
Contact Pad Spacing	C		4.40	
Overall Width	Z			5.85
Contact Pad Width (X8)	X1			0.45
Contact Pad Length (X8)	Y1			1.45
Distance Between Pads	G1	2.95		
Distance Between Pads	GX	0.20		

**Notes:**

1. Dimensioning and tolerancing per ASME Y14.5M

BSC: Basic Dimension. Theoretically exact value shown without tolerances.

Microchip Technology Drawing No. C04-2111A

# MCP4801/4811/4821

## 8-Lead Plastic Dual In-Line (P) – 300 mil Body [PDIP]

**Note:** For the most current package drawings, please see the Microchip Packaging Specification located at <http://www.microchip.com/packages>



Dimension Limits	Units	INCHES		
		MIN	NOM	MAX
Number of Pins	N	8		
Pitch	e	.100 BSC		
Top to Seating Plane	A	–	–	.210
Molded Package Thickness	A2	.115	.130	.195
Base to Seating Plane	A1	.015	–	–
Shoulder to Shoulder Width	E	.290	.310	.325
Molded Package Width	E1	.240	.250	.280
Overall Length	D	.348	.365	.400
Tip to Seating Plane	L	.115	.130	.150
Lead Thickness	c	.008	.010	.015
Upper Lead Width	b1	.040	.060	.070
Lower Lead Width	b	.014	.018	.022
Overall Row Spacing §	eB	–	–	.430

**Notes:**

- Pin 1 visual index feature may vary, but must be located with the hatched area.
- § Significant Characteristic.
- Dimensions D and E1 do not include mold flash or protrusions. Mold flash or protrusions shall not exceed .010" per side.
- Dimensioning and tolerancing per ASME Y14.5M.

BSC: Basic Dimension. Theoretically exact value shown without tolerances.

Microchip Technology Drawing C04-018B



# MCP4801/4811/4821

## 8-Lead Plastic Small Outline (SN) – Narrow, 3.90 mm Body [SOIC]

**Note:** For the most current package drawings, please see the Microchip Packaging Specification located at <http://www.microchip.com/packaging>



Dimension Limits	Units	MILLIMETERS		
		MIN	NOM	MAX
Number of Pins	N	8		
Pitch	e	1.27 BSC		
Overall Height	A	–	–	1.75
Molded Package Thickness	A2	1.25	–	–
Standoff §	A1	0.10	–	0.25
Overall Width	E	6.00 BSC		
Molded Package Width	E1	3.90 BSC		
Overall Length	D	4.90 BSC		
Chamfer (optional)	h	0.25	–	0.50
Foot Length	L	0.40	–	1.27
Footprint	L1	1.04 REF		
Foot Angle	$\phi$	0°	–	8°
Lead Thickness	c	0.17	–	0.25
Lead Width	b	0.31	–	0.51
Mold Draft Angle Top	$\alpha$	5°	–	15°
Mold Draft Angle Bottom	$\beta$	5°	–	15°

**Notes:**

- Pin 1 visual index feature may vary, but must be located within the hatched area.
- § Significant Characteristic.
- Dimensions D and E1 do not include mold flash or protrusions. Mold flash or protrusions shall not exceed 0.15 mm per side.
- Dimensioning and tolerancing per ASME Y14.5M.

BSC: Basic Dimension. Theoretically exact value shown without tolerances.

REF: Reference Dimension, usually without tolerance, for information purposes only.

Microchip Technology Drawing C04-057B

# MCP4801/4811/4821

## 8-Lead Plastic Small Outline (SN) – Narrow, 3.90 mm Body [SOIC]

**Note:** For the most current package drawings, please see the Microchip Packaging Specification located at <http://www.microchip.com/packaging>



RECOMMENDED LAND PATTERN

Units		MILLIMETERS		
Dimension Limits		MIN	NOM	MAX
Contact Pitch	E	1.27 BSC		
Contact Pad Spacing	C		5.40	
Contact Pad Width (X8)	X1			0.60
Contact Pad Length (X8)	Y1			1.55

Notes:

1. Dimensioning and tolerancing per ASME Y14.5M

BSC: Basic Dimension. Theoretically exact value shown without tolerances.

Microchip Technology Drawing No. C04-2057A

## APPENDIX A: REVISION HISTORY

### Revision A (April 2010)

- Original Release of this Document.

### Revision B (April 2010)

- Corrected the “**Related Products**” table on page 1.

# MCP4801/4811/4821

---

NOTES:

## PRODUCT IDENTIFICATION SYSTEM

To order or obtain information, e.g., on pricing or delivery, refer to the factory or the listed sales office.

<u>PART NO.</u>	<u>X</u>	<u>/XX</u>	
Device	Temperature Range	Package	
Device	MCP4801:	8-Bit Voltage Output DAC	
	MCP4801T:	8-Bit Voltage Output DAC (Tape and Reel, DFN, MSOP and SOIC only)	
	MCP4811:	10-Bit Voltage Output DAC	
	MCP4811T:	10-Bit Voltage Output DAC (Tape and Reel, DFN, MSOP and SOIC only)	
	MCP4821:	12-Bit Voltage Output DAC	
	MCP4821T:	12-Bit Voltage Output DAC (Tape and Reel, DFN, MSOP and SOIC only)	
Temperature Range	E	= -40°C to +125°C	(Extended)
Package	MC	= 8-Lead Plastic Dual Flat, No Lead Package - 2x3x0.9 mm Body (DFN)	
	MS	= 8-Lead Plastic Micro Small Outline (MSOP)	
	P	= 8-Lead Plastic Dual In-Line (PDIP)	
	SN	= 8-Lead Plastic Small Outline - Narrow, 150 mil (SOIC)	

<b>Examples:</b>	
a)	MCP4801-E/MC: Extended temperature, DFN package
b)	MCP4801T-E/MC: Extended temperature, DFN package, Tape and Reel
c)	MCP4801-E/MS: Extended temperature, MSOP package.
d)	MCP4801T-E/MS: Extended temperature, MSOP package, Tape and Reel.
e)	MCP4801-E/P: Extended temperature, PDIP package.
f)	MCP4801-E/SN: Extended temperature, SOIC package.
g)	MCP4801T-E/SN: Extended temperature, SOIC package, Tape and Reel.
a)	MCP4811-E/MC: Extended temperature, DFN package
b)	MCP4811T-E/MC: Extended temperature, DFN package, Tape and Reel
c)	MCP4811-E/MS: Extended temperature, MSOP package.
d)	MCP4811T-E/MS: Extended temperature, MSOP package, Tape and Reel.
e)	MCP4811-E/P: Extended temperature, PDIP package.
f)	MCP4811-E/SN: Extended temperature, SOIC package.
g)	MCP4811T-E/SN: Extended temperature, SOIC package, Tape and Reel.
a)	MCP4821-E/MC: Extended temperature, DFN package
b)	MCP4821T-E/MC: Extended temperature, DFN package, Tape and Reel
c)	MCP4821-E/MS: Extended temperature, MSOP package.
d)	MCP4821T-E/MS: Extended temperature, MSOP package, Tape and Reel.
e)	MCP4821-E/P: Extended temperature, PDIP package.
f)	MCP4821-E/SN: Extended temperature, SOIC package.
g)	MCP4821T-E/SN: Extended temperature, SOIC package, Tape and Reel.

# MCP4801/4811/4821

---

NOTES:

---

**Note the following details of the code protection feature on Microchip devices:**

- Microchip products meet the specification contained in their particular Microchip Data Sheet.
- Microchip believes that its family of products is one of the most secure families of its kind on the market today, when used in the intended manner and under normal conditions.
- There are dishonest and possibly illegal methods used to breach the code protection feature. All of these methods, to our knowledge, require using the Microchip products in a manner outside the operating specifications contained in Microchip's Data Sheets. Most likely, the person doing so is engaged in theft of intellectual property.
- Microchip is willing to work with the customer who is concerned about the integrity of their code.
- Neither Microchip nor any other semiconductor manufacturer can guarantee the security of their code. Code protection does not mean that we are guaranteeing the product as “unbreakable.”

Code protection is constantly evolving. We at Microchip are committed to continuously improving the code protection features of our products. Attempts to break Microchip's code protection feature may be a violation of the Digital Millennium Copyright Act. If such acts allow unauthorized access to your software or other copyrighted work, you may have a right to sue for relief under that Act.

---

Information contained in this publication regarding device applications and the like is provided only for your convenience and may be superseded by updates. It is your responsibility to ensure that your application meets with your specifications. MICROCHIP MAKES NO REPRESENTATIONS OR WARRANTIES OF ANY KIND WHETHER EXPRESS OR IMPLIED, WRITTEN OR ORAL, STATUTORY OR OTHERWISE, RELATED TO THE INFORMATION, INCLUDING BUT NOT LIMITED TO ITS CONDITION, QUALITY, PERFORMANCE, MERCHANTABILITY OR FITNESS FOR PURPOSE. Microchip disclaims all liability arising from this information and its use. Use of Microchip devices in life support and/or safety applications is entirely at the buyer's risk, and the buyer agrees to defend, indemnify and hold harmless Microchip from any and all damages, claims, suits, or expenses resulting from such use. No licenses are conveyed, implicitly or otherwise, under any Microchip intellectual property rights.

**Trademarks**

The Microchip name and logo, the Microchip logo, dsPIC, KEELOQ, KEELOQ logo, MPLAB, PIC, PICmicro, PICSTART, PIC<sup>32</sup> logo, rPIC and UNI/O are registered trademarks of Microchip Technology Incorporated in the U.S.A. and other countries.

FilterLab, Hampshire, HI-TECH C, Linear Active Thermistor, MXDEV, MXLAB, SEEVAL and The Embedded Control Solutions Company are registered trademarks of Microchip Technology Incorporated in the U.S.A.

Analog-for-the-Digital Age, Application Maestro, CodeGuard, dsPICDEM, dsPICDEM.net, dsPICworks, dsSPEAK, ECAN, ECONOMONITOR, FanSense, HI-TIDE, In-Circuit Serial Programming, ICSP, Mindi, MiWi, MPASM, MPLAB Certified logo, MPLIB, MPLINK, mTouch, Octopus, Omniscient Code Generation, PICC, PICC-18, PICDEM, PICDEM.net, PICkit, PICTail, REAL ICE, rLAB, Select Mode, Total Endurance, TSHARC, UniWinDriver, WiperLock and ZENA are trademarks of Microchip Technology Incorporated in the U.S.A. and other countries.

SQTP is a service mark of Microchip Technology Incorporated in the U.S.A.

All other trademarks mentioned herein are property of their respective companies.

© 2010, Microchip Technology Incorporated, Printed in the U.S.A., All Rights Reserved.

 Printed on recycled paper.

ISBN: 978-1-60932-124-6

*Microchip received ISO/TS-16949:2002 certification for its worldwide headquarters, design and wafer fabrication facilities in Chandler and Tempe, Arizona; Gresham, Oregon and design centers in California and India. The Company's quality system processes and procedures are for its PIC® MCUs and dsPIC® DSCs, KEELOQ® code hopping devices, Serial EEPROMs, microperipherals, nonvolatile memory and analog products. In addition, Microchip's quality system for the design and manufacture of development systems is ISO 9001:2000 certified.*

**QUALITY MANAGEMENT SYSTEM  
CERTIFIED BY DNV  
== ISO/TS 16949:2002 ==**



## WORLDWIDE SALES AND SERVICE

### AMERICAS

**Corporate Office**  
2355 West Chandler Blvd.  
Chandler, AZ 85224-6199  
Tel: 480-792-7200  
Fax: 480-792-7277  
Technical Support:  
<http://support.microchip.com>  
Web Address:  
[www.microchip.com](http://www.microchip.com)

**Atlanta**  
Duluth, GA  
Tel: 678-957-9614  
Fax: 678-957-1455

**Boston**  
Westborough, MA  
Tel: 774-760-0087  
Fax: 774-760-0088

**Chicago**  
Itasca, IL  
Tel: 630-285-0071  
Fax: 630-285-0075

**Cleveland**  
Independence, OH  
Tel: 216-447-0464  
Fax: 216-447-0643

**Dallas**  
Addison, TX  
Tel: 972-818-7423  
Fax: 972-818-2924

**Detroit**  
Farmington Hills, MI  
Tel: 248-538-2250  
Fax: 248-538-2260

**Kokomo**  
Kokomo, IN  
Tel: 765-864-8360  
Fax: 765-864-8387

**Los Angeles**  
Mission Viejo, CA  
Tel: 949-462-9523  
Fax: 949-462-9608

**Santa Clara**  
Santa Clara, CA  
Tel: 408-961-6444  
Fax: 408-961-6445

**Toronto**  
Mississauga, Ontario,  
Canada  
Tel: 905-673-0699  
Fax: 905-673-6509

### ASIA/PACIFIC

**Asia Pacific Office**  
Suites 3707-14, 37th Floor  
Tower 6, The Gateway  
Harbour City, Kowloon  
Hong Kong  
Tel: 852-2401-1200  
Fax: 852-2401-3431

**Australia - Sydney**  
Tel: 61-2-9868-6733  
Fax: 61-2-9868-6755

**China - Beijing**  
Tel: 86-10-8528-2100  
Fax: 86-10-8528-2104

**China - Chengdu**  
Tel: 86-28-8665-5511  
Fax: 86-28-8665-7889

**China - Chongqing**  
Tel: 86-23-8980-9588  
Fax: 86-23-8980-9500

**China - Hong Kong SAR**  
Tel: 852-2401-1200  
Fax: 852-2401-3431

**China - Nanjing**  
Tel: 86-25-8473-2460  
Fax: 86-25-8473-2470

**China - Qingdao**  
Tel: 86-532-8502-7355  
Fax: 86-532-8502-7205

**China - Shanghai**  
Tel: 86-21-5407-5533  
Fax: 86-21-5407-5066

**China - Shenyang**  
Tel: 86-24-2334-2829  
Fax: 86-24-2334-2393

**China - Shenzhen**  
Tel: 86-755-8203-2660  
Fax: 86-755-8203-1760

**China - Wuhan**  
Tel: 86-27-5980-5300  
Fax: 86-27-5980-5118

**China - Xian**  
Tel: 86-29-8833-7252  
Fax: 86-29-8833-7256

**China - Xiamen**  
Tel: 86-592-2388138  
Fax: 86-592-2388130

**China - Zhuhai**  
Tel: 86-756-3210040  
Fax: 86-756-3210049

### ASIA/PACIFIC

**India - Bangalore**  
Tel: 91-80-3090-4444  
Fax: 91-80-3090-4123

**India - New Delhi**  
Tel: 91-11-4160-8631  
Fax: 91-11-4160-8632

**India - Pune**  
Tel: 91-20-2566-1512  
Fax: 91-20-2566-1513

**Japan - Yokohama**  
Tel: 81-45-471- 6166  
Fax: 81-45-471-6122

**Korea - Daegu**  
Tel: 82-53-744-4301  
Fax: 82-53-744-4302

**Korea - Seoul**  
Tel: 82-2-554-7200  
Fax: 82-2-558-5932 or  
82-2-558-5934

**Malaysia - Kuala Lumpur**  
Tel: 60-3-6201-9857  
Fax: 60-3-6201-9859

**Malaysia - Penang**  
Tel: 60-4-227-8870  
Fax: 60-4-227-4068

**Philippines - Manila**  
Tel: 63-2-634-9065  
Fax: 63-2-634-9069

**Singapore**  
Tel: 65-6334-8870  
Fax: 65-6334-8850

**Taiwan - Hsin Chu**  
Tel: 886-3-6578-300  
Fax: 886-3-6578-370

**Taiwan - Kaohsiung**  
Tel: 886-7-536-4818  
Fax: 886-7-536-4803

**Taiwan - Taipei**  
Tel: 886-2-2500-6610  
Fax: 886-2-2508-0102

**Thailand - Bangkok**  
Tel: 66-2-694-1351  
Fax: 66-2-694-1350

### EUROPE

**Austria - Wels**  
Tel: 43-7242-2244-39  
Fax: 43-7242-2244-393

**Denmark - Copenhagen**  
Tel: 45-4450-2828  
Fax: 45-4485-2829

**France - Paris**  
Tel: 33-1-69-53-63-20  
Fax: 33-1-69-30-90-79

**Germany - Munich**  
Tel: 49-89-627-144-0  
Fax: 49-89-627-144-44

**Italy - Milan**  
Tel: 39-0331-742611  
Fax: 39-0331-466781

**Netherlands - Drunen**  
Tel: 31-416-690399  
Fax: 31-416-690340

**Spain - Madrid**  
Tel: 34-91-708-08-90  
Fax: 34-91-708-08-91

**UK - Wokingham**  
Tel: 44-118-921-5869  
Fax: 44-118-921-5820



## Данный компонент на территории Российской Федерации

### Вы можете приобрести в компании MosChip.

Для оперативного оформления запроса Вам необходимо перейти по данной ссылке:

<http://moschip.ru/get-element>

Вы можете разместить у нас заказ для любого Вашего проекта, будь то серийное производство или разработка единичного прибора.

В нашем ассортименте представлены ведущие мировые производители активных и пассивных электронных компонентов.

Нашей специализацией является поставка электронной компонентной базы двойного назначения, продукции таких производителей как XILINX, Intel (ex.ALTERA), Vicor, Microchip, Texas Instruments, Analog Devices, Mini-Circuits, Amphenol, Glenair.

Сотрудничество с глобальными дистрибьюторами электронных компонентов, предоставляет возможность заказывать и получать с международных складов практически любой перечень компонентов в оптимальные для Вас сроки.

На всех этапах разработки и производства наши партнеры могут получить квалифицированную поддержку опытных инженеров.

Система менеджмента качества компании отвечает требованиям в соответствии с ГОСТ Р ИСО 9001, ГОСТ РВ 0015-002 и ЭС РД 009

### Офис по работе с юридическими лицами:

105318, г.Москва, ул.Щербаковская д.3, офис 1107, 1118, ДЦ «Щербаковский»

Телефон: +7 495 668-12-70 (многоканальный)

Факс: +7 495 668-12-70 (доб.304)

E-mail: [info@moschip.ru](mailto:info@moschip.ru)

Skype отдела продаж:

moschip.ru

moschip.ru\_4

moschip.ru\_6

moschip.ru\_9