

ZXMC4559DN8

COMPLEMENTARY 60V ENHANCEMENT MODE MOSFET

SUMMARY

N-Channel $V_{(BR)DSS} = 60V$; $R_{DS(ON)} = 0.055\Omega$; $I_D = 4.7A$

P-Channel $V_{(BR)DSS} = -60V$; $R_{DS(ON)} = 0.105\Omega$; $I_D = -3.9A$

DESCRIPTION

This new generation of TRENCH MOSFETs from Zetex utilizes a unique structure that combines the benefits of low on-resistance with fast switching speed. This makes them ideal for high efficiency, low voltage, power management applications.

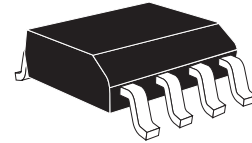

SO8

FEATURES

- Low on-resistance
- Fast switching speed
- Low threshold
- Low gate drive
- Low profile SOIC package

APPLICATIONS

- Motor Drive
- LCD backlighting

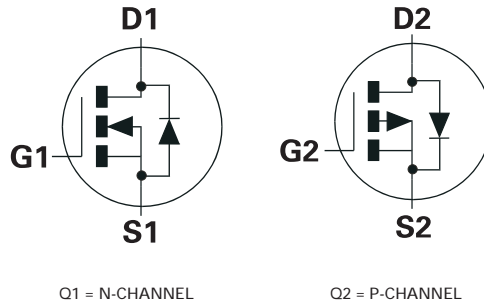

ORDERING INFORMATION

DEVICE	REEL	TAPE WIDTH	QUANTITY PER REEL
ZXMC4559DN8TA	7"	12mm	500 units
ZXMC4559DN8TC	13"	12mm	2500 units

DEVICE MARKING

- ZXMC
4559

PINOUT

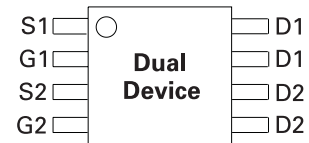

Top view

ZXMC4559DN8

ABSOLUTE MAXIMUM RATINGS.

PARAMETER	SYMBOL	N-Channel	P-Channel	UNIT
Drain-Source Voltage	V_{DSS}	60	-60	V
Gate-Source Voltage	V_{GS}	± 20	± 20	V
Continuous Drain Current @ $V_{GS}=10V$; $T_A=25^\circ C$ (b) (d)	I_D	4.7	-3.9	A
		3.7	-2.8	A
		3.6	-2.6	A
Pulsed Drain Current (c)	I_{DM}	22.2	-18.3	A
Continuous Source Current (Body Diode) (b)	I_S	3.4	-3.2	A
Pulsed Source Current (Body Diode)(c)	I_{SM}	22.2	-18.3	A
Power Dissipation at $T_A=25^\circ C$ (a) (d)	P_D	1.25		W
Linear Derating Factor		10		mW/ $^\circ C$
Power Dissipation at $T_A=25^\circ C$ (a) (e)	P_D	1.8		W
Linear Derating Factor		14		mW/ $^\circ C$
Power Dissipation at $T_A=25^\circ C$ (b) (d)	P_D	2.1		W
Linear Derating Factor		17		mW/ $^\circ C$
Operating and Storage Temperature Range	$T_J; T_{stg}$	-55 to +150		$^\circ C$

THERMAL RESISTANCE

PARAMETER	SYMBOL	VALUE	UNIT
Junction to Ambient (a) (d)	$R_{\theta JA}$	100	$^\circ C/W$
Junction to Ambient (b) (e)	$R_{\theta JA}$	69	$^\circ C/W$
Junction to Ambient (b) (d)	$R_{\theta JA}$	58	$^\circ C/W$

Notes

- (a) For a dual device surface mounted on 25mm x 25mm FR4 PCB with coverage of single sided 1oz copper in still air conditions.
- (b) For a dual device surface mounted on FR4 PCB measured at $t \leq 10$ sec.
- (c) Repetitive rating 25mm x 25mm FR4 PCB, $D=0.02$ pulse width=300 μs - pulse width limited by maximum junction temperature.
- (d) For a device with one active die.
- (e) For device with 2 active die running at equal power.

ZXMC4559DN8

CHARACTERISTICS

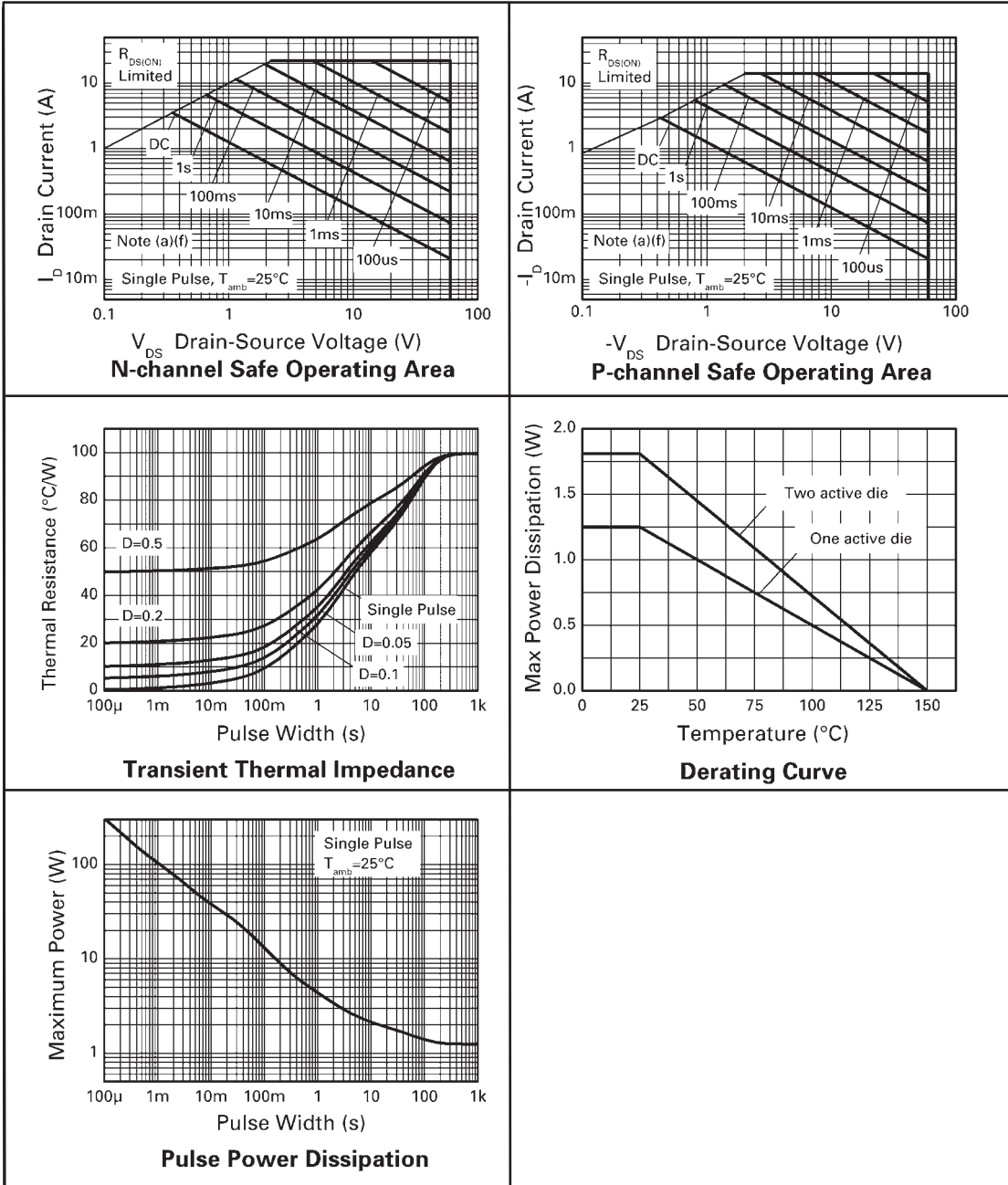

ZXMC4559DN8

N-CHANNEL

ELECTRICAL CHARACTERISTICS (at $T_{amb} = 25^{\circ}\text{C}$ unless otherwise stated).

PARAMETER	SYMBOL	MIN.	TYP.	MAX.	UNIT	CONDITIONS.
STATIC						
Drain-Source Breakdown Voltage	$V_{(BR)DSS}$	60			V	$I_D=250\mu\text{A}, V_{GS}=0\text{V}$
Zero Gate Voltage Drain Current	I_{DSS}			1.0	μA	$V_{DS}=60\text{V}, V_{GS}=0\text{V}$
Gate-Body Leakage	I_{GSS}			100	nA	$V_{GS}=\pm 20\text{V}, V_{DS}=0\text{V}$
Gate-Source Threshold Voltage	$V_{GS(th)}$	1.0			V	$I_D=250\mu\text{A}, V_{DS}=V_{GS}$
Static Drain-Source On-State Resistance ⁽¹⁾	$R_{DS(on)}$			0.055 0.075	Ω Ω	$V_{GS}=10\text{V}, I_D=4.5\text{A}$ $V_{GS}=4.5\text{V}, I_D=4.0\text{A}$
Forward Transconductance ^{(1) (3)}	g_{fs}		10.2		S	$V_{DS}=15\text{V}, I_D=4.5\text{A}$
DYNAMIC ⁽³⁾						
Input Capacitance	C_{iss}		1063		pF	$V_{DS}=30\text{V}, V_{GS}=0\text{V},$ $f=1\text{MHz}$
Output Capacitance	C_{oss}		104		pF	
Reverse Transfer Capacitance	C_{rss}		64		pF	
SWITCHING ^{(2) (3)}						
Turn-On Delay Time	$t_{d(on)}$		3.5		ns	$V_{DD}=30\text{V}, I_D=1\text{A}$ $R_G=6.0\Omega, V_{GS}=10\text{V}$
Rise Time	t_r		4.1		ns	
Turn-Off Delay Time	$t_{d(off)}$		26.2		ns	
Fall Time	t_f		10.6		ns	
Gate Charge	Q_g		11.0		nC	$V_{DS}=30\text{V}, V_{GS}=5\text{V},$ $I_D=4.5\text{A}$
Total Gate Charge	Q_g		20.4		nC	$V_{DS}=30\text{V}, V_{GS}=10\text{V},$ $I_D=4.5\text{A}$
Gate-Source Charge	Q_{gs}		4.1		nC	
Gate-Drain Charge	Q_{gd}		5.1		nC	
SOURCE-DRAIN DIODE						
Diode Forward Voltage ⁽¹⁾	V_{SD}		0.85	1.2	V	$T_J=25^{\circ}\text{C}, I_S=5.5\text{A},$ $V_{GS}=0\text{V}$
Reverse Recovery Time ⁽³⁾	t_{rr}		22		ns	$T_J=25^{\circ}\text{C}, I_F=2.2\text{A},$
Reverse Recovery Charge ⁽³⁾	Q_{rr}		21.4		nC	$di/dt=100\text{A}/\mu\text{s}$

NOTES

- (1) Measured under pulsed conditions. Width $\leq 300\mu\text{s}$. Duty cycle $\leq 2\%$.
 (2) Switching characteristics are independent of operating junction temperature.
 (3) For design aid only, not subject to production testing.

ZXMC4559DN8

P-CHANNEL

ELECTRICAL CHARACTERISTICS (at $T_{amb} = 25^{\circ}\text{C}$ unless otherwise stated)

PARAMETER	SYMBOL	MIN.	TYP.	MAX.	UNIT	CONDITIONS
STATIC						
Drain-Source Breakdown Voltage	$V_{(BR)DSS}$	-60			V	$I_D = -250\mu\text{A}$, $V_{GS} = 0\text{V}$
Zero Gate Voltage Drain Current	I_{DSS}			-1.0	μA	$V_{DS} = -60\text{V}$, $V_{GS} = 0\text{V}$
Gate-Body Leakage	I_{GSS}			100	nA	$V_{GS} = \pm 20\text{V}$, $V_{DS} = 0\text{V}$
Gate-Source Threshold Voltage	$V_{GS(th)}$	-1.0			V	$I_D = -250\mu\text{A}$, $V_{DS} = V_{GS}$
Static Drain-Source On-State Resistance ⁽¹⁾	$R_{DS(on)}$			0.085 0.125	Ω Ω	$V_{GS} = -10\text{V}$, $I_D = -2.9\text{A}$ $V_{GS} = -4.5\text{V}$, $I_D = -2.4\text{A}$
Forward Transconductance ^{(1) (3)}	g_{fs}		7.2		S	$V_{DS} = -15\text{V}$, $I_D = -2.9\text{A}$
DYNAMIC ⁽³⁾						
Input Capacitance	C_{iss}		1021		pF	$V_{DS} = -30\text{V}$, $V_{GS} = 0\text{V}$, $f = 1\text{MHz}$
Output Capacitance	C_{oss}		83.1		pF	
Reverse Transfer Capacitance	C_{rss}		56.4		pF	
SWITCHING ^{(2) (3)}						
Turn-On Delay Time	$t_{d(on)}$		3.5		ns	$V_{DD} = -30\text{V}$, $I_D = -1\text{A}$ $R_G = 6.0\Omega$, $V_{GS} = -10\text{V}$
Rise Time	t_r		4.1		ns	
Turn-Off Delay Time	$t_{d(off)}$		35		ns	
Fall Time	t_f		10		ns	
Gate Charge	Q_g		12.1		nC	$V_{DS} = -30\text{V}$, $V_{GS} = -5\text{V}$, $I_D = -2.9\text{A}$
Total Gate Charge	Q_g		24.2		nC	$V_{DS} = -30\text{V}$, $V_{GS} = -10\text{V}$, $I_D = -2.9\text{A}$
Gate-Source Charge	Q_{gs}		2.5		nC	
Gate-Drain Charge	Q_{gd}		3.7		nC	
SOURCE-DRAIN DIODE						
Diode Forward Voltage ⁽¹⁾	V_{SD}		-0.85	-0.95	V	$T_J = 25^{\circ}\text{C}$, $I_S = -3.4\text{A}$, $V_{GS} = 0\text{V}$
Reverse Recovery Time ⁽³⁾	t_{rr}		29.2		ns	$T_J = 25^{\circ}\text{C}$, $I_F = -2\text{A}$, $di/dt = 100\text{A}/\mu\text{s}$
Reverse Recovery Charge ⁽³⁾	Q_{rr}		39.6		nC	

NOTES

- (1) Measured under pulsed conditions. Width $\leq 300\mu\text{s}$. Duty cycle $\leq 2\%$.
(2) Switching characteristics are independent of operating junction temperature.
(3) For design aid only, not subject to production testing.

ZXMC4559DN8

N-CHANNEL TYPICAL CHARACTERISTICS

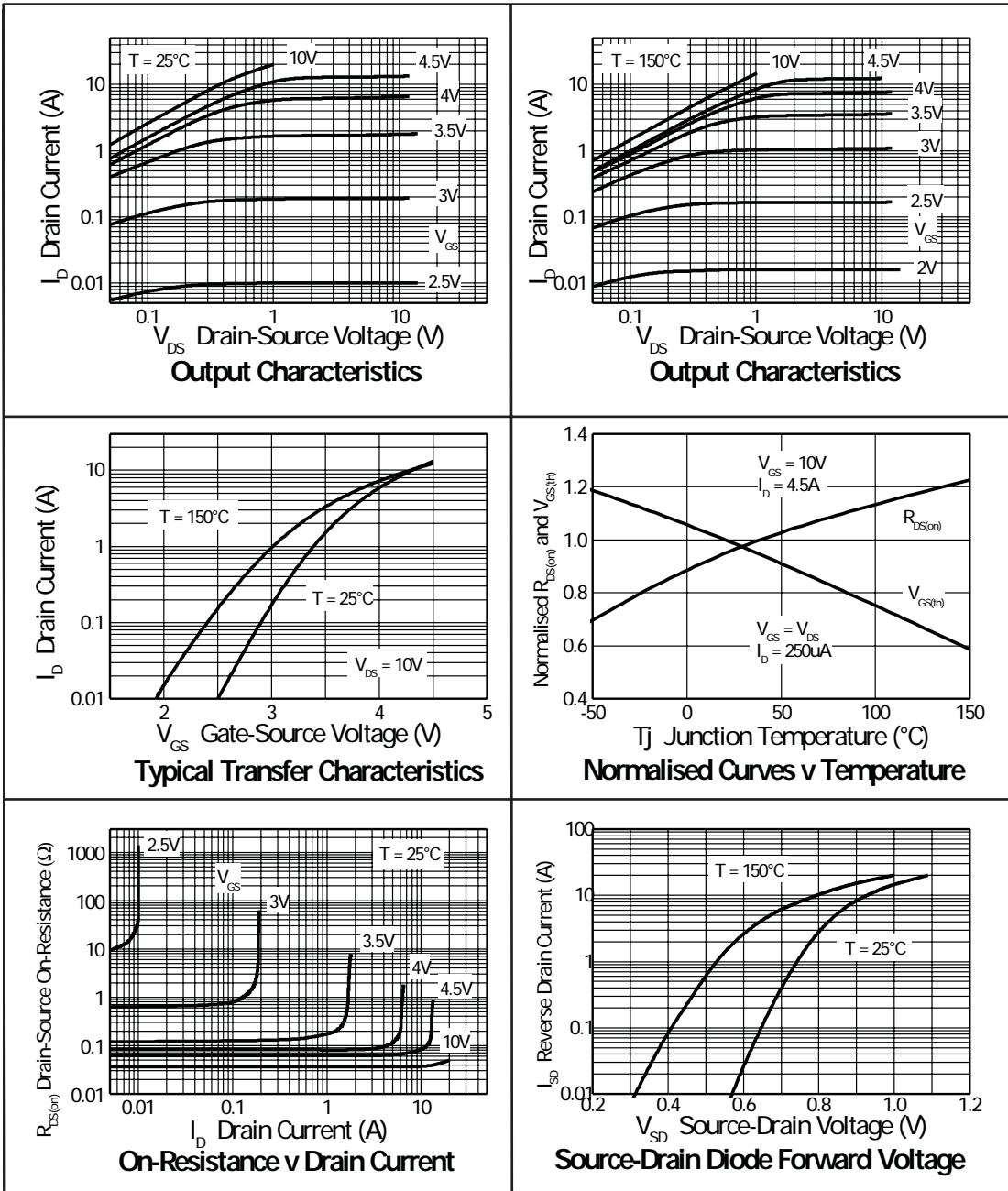

ZXMC4559DN8

N-CHANNEL TYPICAL CHARACTERISTICS

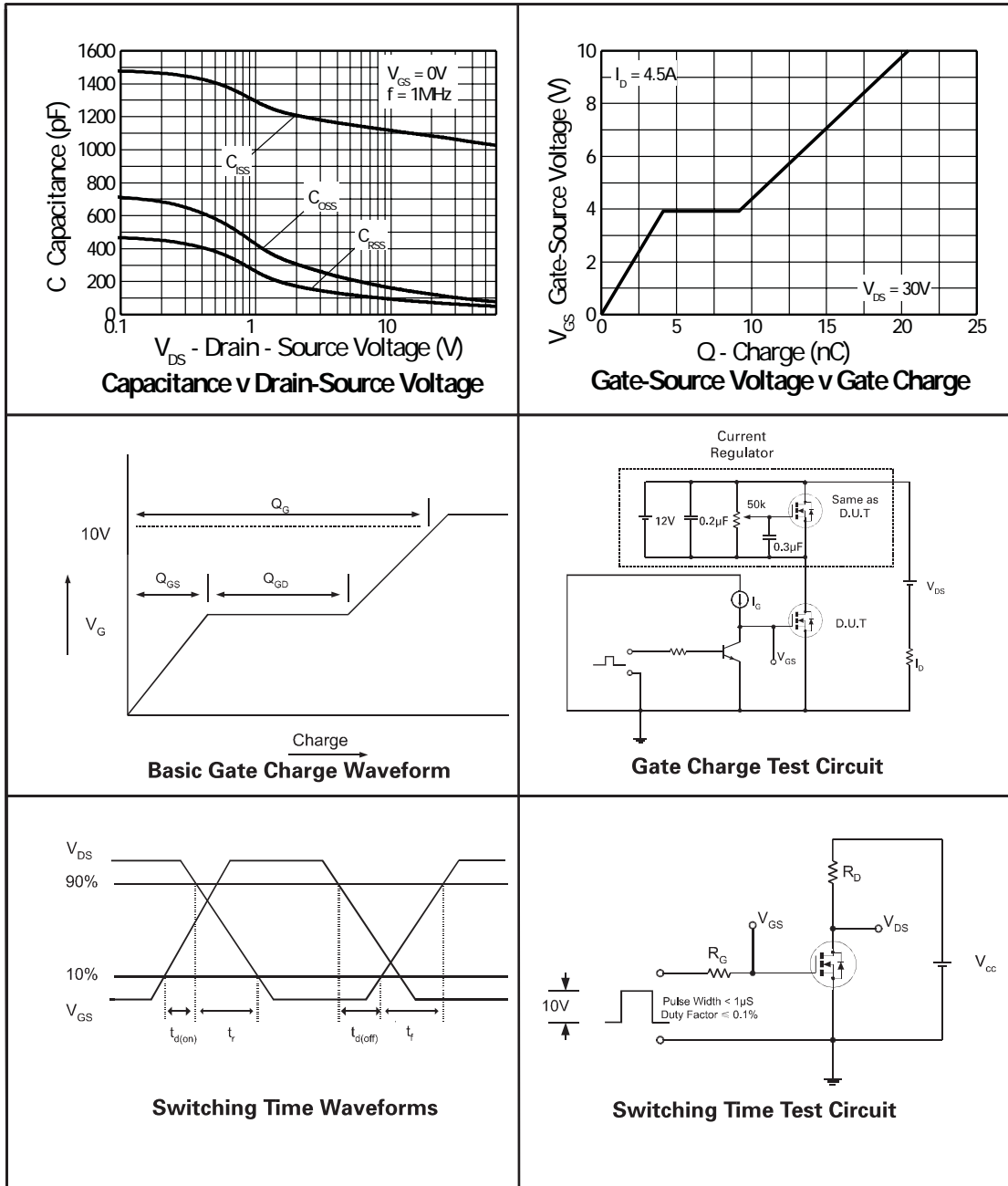

ZXMC4559DN8

P-CHANNEL TYPICAL CHARACTERISTICS

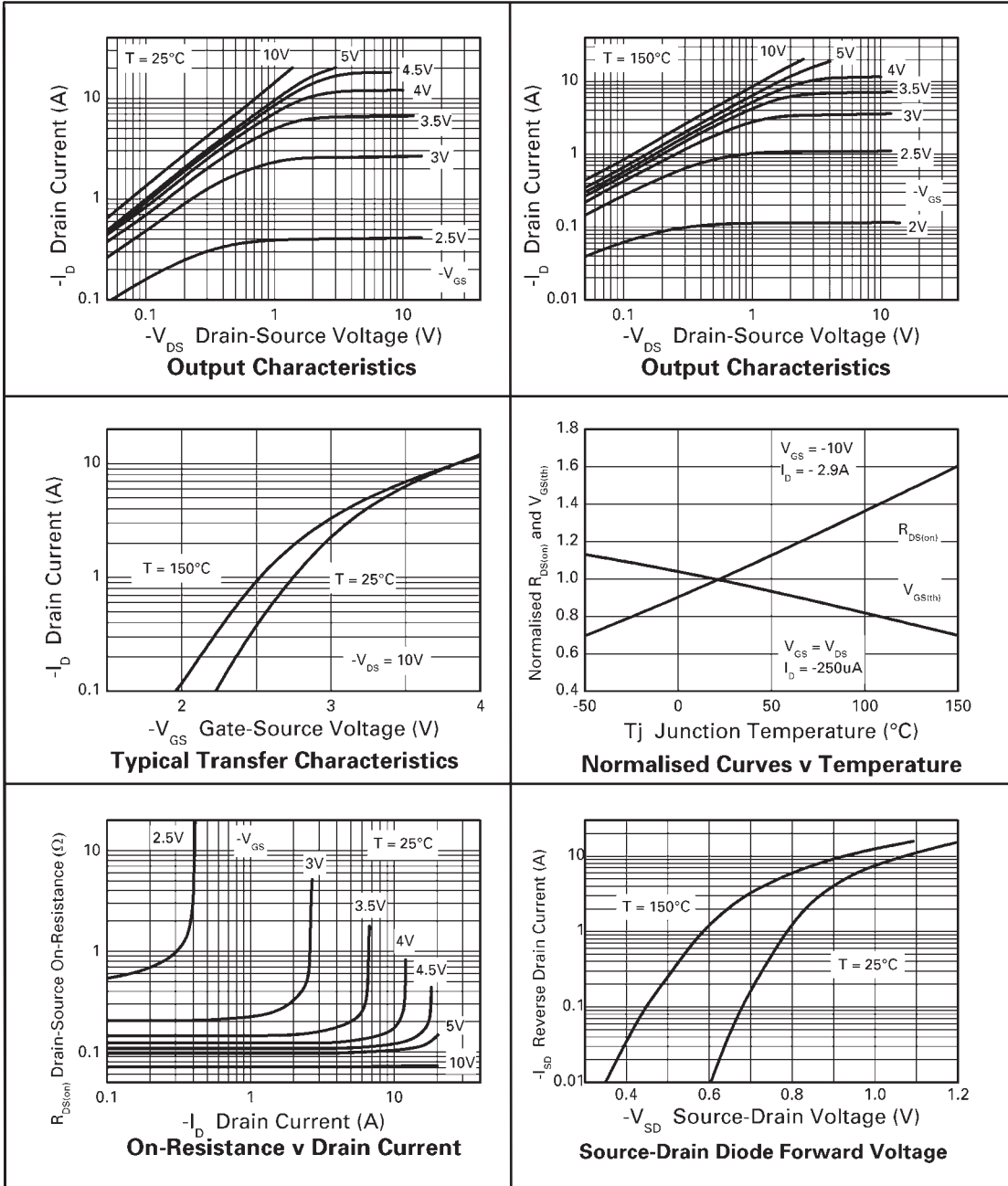

ZXMC4559DN8

P-CHANNEL TYPICAL CHARACTERISTICS

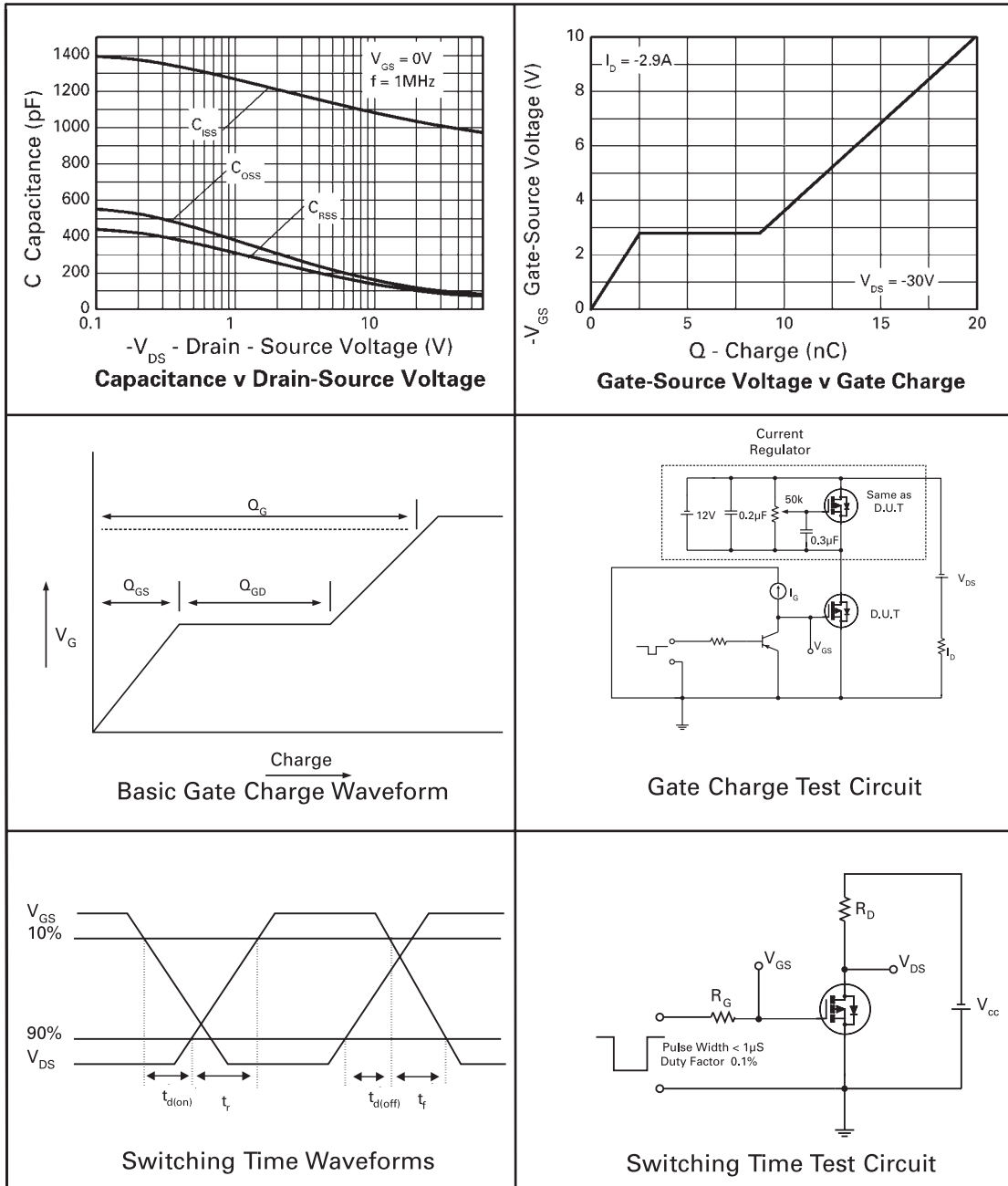

ZXMC4559DN8

PACKAGE OUTLINE

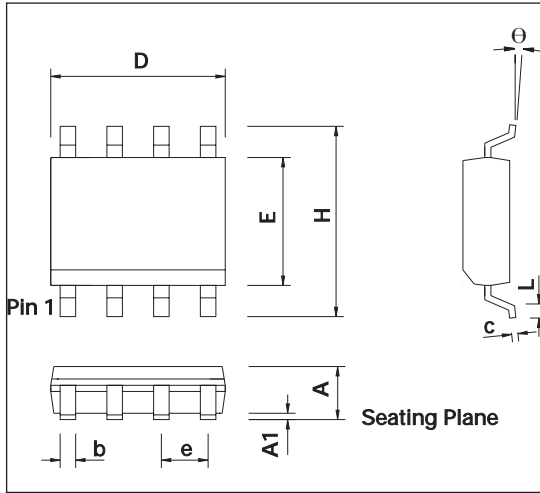

CONTROLLING DIMENSIONS ARE IN INCHES
APPROX IN MILLIMETRES

PACKAGE DIMENSIONS

DIM	INCHES		MILLIMETRES	
	MIN	MAX	MIN	MAX
A	0.053	0.069	1.35	1.75
A1	0.004	0.010	0.10	0.25
D	0.189	0.197	4.80	5.00
H	0.228	0.244	5.80	6.20
E	0.150	0.157	3.80	4.00
L	0.016	0.050	0.40	1.27
e	0.050 BSC		1.27 BSC	
b	0.013	0.020	0.33	0.51
c	0.008	0.010	0.19	0.25
θ	0°	8°	0°	8°
h	0.010	0.020	0.25	0.50

© Zetex Semiconductors plc 2005

Europe	Americas	Asia Pacific	Corporate Headquarters
Zetex GmbH Streitfeldstraße 19 D-81673 München Germany	Zetex Inc 700 Veterans Memorial Hwy Hauppauge, NY 11788 USA	Zetex (Asia) Ltd 3701-04 Metroplaza Tower 1 Hing Fong Road, Kwai Fong Hong Kong	Zetex Semiconductors plc Zetex Technology Park Chadderton, Oldham, OL9 9LL United Kingdom
Telefon: (49) 89 45 49 49 0 Fax: (49) 89 45 49 49 49 europa.sales@zetex.com	Telephone: (1) 631 360 2222 Fax: (1) 631 360 8222 usa.sales@zetex.com	Telephone: (852) 26100 611 Fax: (852) 24250 494 asia.sales@zetex.com	Telephone (44) 161 622 4444 Fax: (44) 161 622 4446 hq@zetex.com

These offices are supported by agents and distributors in major countries world-wide.

This publication is issued to provide outline information only which (unless agreed by the Company in writing) may not be used, applied or reproduced for any purpose or form part of any order or contract or be regarded as a representation relating to the products or services concerned. The Company reserves the right to alter without notice the specification, design, price or conditions of supply of any product or service.

For the latest product information, log on to www.zetex.com



ISSUE 5 - MAY 2005

Данный компонент на территории Российской Федерации

Вы можете приобрести в компании MosChip.

Для оперативного оформления запроса Вам необходимо перейти по данной ссылке:

<http://moschip.ru/get-element>

Вы можете разместить у нас заказ для любого Вашего проекта, будь то серийное производство или разработка единичного прибора.

В нашем ассортименте представлены ведущие мировые производители активных и пассивных электронных компонентов.

Нашей специализацией является поставка электронной компонентной базы двойного назначения, продукции таких производителей как XILINX, Intel (ex.ALTERA), Vicor, Microchip, Texas Instruments, Analog Devices, Mini-Circuits, Amphenol, Glenair.

Сотрудничество с глобальными дистрибьюторами электронных компонентов, предоставляет возможность заказывать и получать с международных складов практически любой перечень компонентов в оптимальные для Вас сроки.

На всех этапах разработки и производства наши партнеры могут получить квалифицированную поддержку опытных инженеров.

Система менеджмента качества компании отвечает требованиям в соответствии с ГОСТ Р ИСО 9001, ГОСТ РВ 0015-002 и ЭС РД 009

Офис по работе с юридическими лицами:

105318, г.Москва, ул.Щербаковская д.3, офис 1107, 1118, ДЦ «Щербаковский»

Телефон: +7 495 668-12-70 (многоканальный)

Факс: +7 495 668-12-70 (доб.304)

E-mail: info@moschip.ru

Skype отдела продаж:

moschip.ru

moschip.ru_4

moschip.ru_6

moschip.ru_9