



# HDMI05-CL02F3

## 5-line IPAD™, HDMI™ control line ESD protection

### Features

- Low line capacitance: 12 pF max.
- High efficiency in ESD protection
- Lead-free package
- Very thin package
- High reliability offered by monolithic integration
- High reduction of parasitic elements through integration and wafer level packaging

### Complies with the standards:

- IEC 61000-4-2 Level 4
  - ± 15 kV (air discharge)
  - ± 8 kV (contact discharge)
- IEC 61000-4-2 Level 1
  - ± 2 kV (air discharge)
  - ± 2 kV (contact discharge)

### Application

Where ESD protection for HDMI control lines (CEC, HPD, SCL and SDA) is required:

- Mobile phones and communication systems
- Portable multimedia players
- Camcorder, digital still cameras

### Description

The HDMI05-CL02F3 chip is a low capacitance ESD protection for HDMI control pins. It also integrates pull-up resistor for I<sup>2</sup>C bus and pull-down resistor for hot plug detect and pull-up resistor for CEC line.

The ESD protection circuitry prevents damage to the protected device when subjected to ESD surges up to 15 kV.

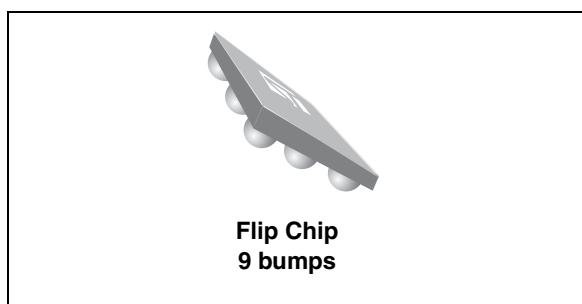

Figure 1. Pin configuration (bump side)

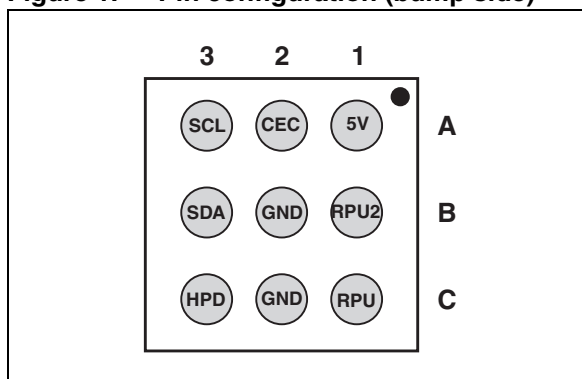
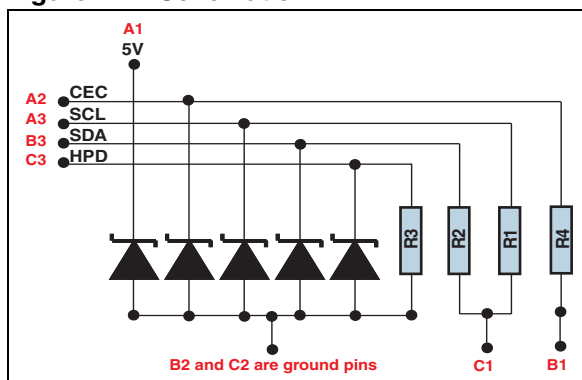

Figure 2. Schematic



TM: IPAD is a trademark of STMicroelectronics. HDMI, the HDMI logo and High-Definition Multimedia Interface are trademarks or registered trademarks of HDMI Licensing LLC.

# 1 Characteristics

**Table 1. Absolute maximum ratings ( $T_{amb} = 25\text{ }^{\circ}\text{C}$ )**

Symbol	Parameter	Value	Unit
$V_{PP}$	External pins (A1, A2, A3, B3 and C3):		
	ESD IEC 61000-4-2, level 4 - air discharge	15	kV
	ESD IEC 61000-4-2, level 4 - contact discharge	8	
	Internal pins (B1, C1):		
	ESD IEC 61000-4-2, level 1 - air discharge	2	
ESD IEC 61000-4-2, level 1 - contact discharge	2		
$P_d$	Line resistance power dissipation at $70\text{ }^{\circ}\text{C}$	60	mW
$T_{op}$	Operating temperature range	-30 to + 85	$^{\circ}\text{C}$
$T_{stg}$	Storage temperature range	-55 to + 150	$^{\circ}\text{C}$

**Figure 3. Electrical characteristics (definitions)**

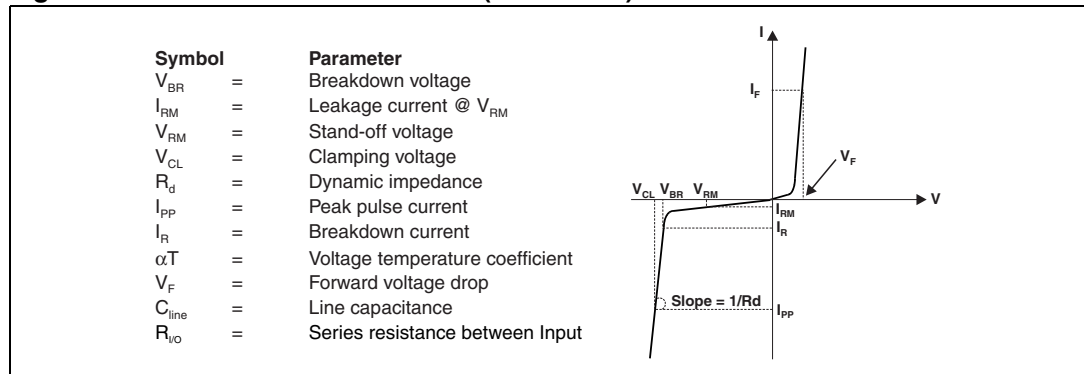

**Table 2. Electrical characteristics ( $T_{amb} = 25\text{ }^{\circ}\text{C}$ )**

Symbol	Test condition	Min.	Typ.	Max.	Unit
$V_{BR}$	$I_R = 1\text{ mA}$	6		20	V
$I_{RM}$	$V_{RM} = 3\text{ V per line}$		50	200	nA
$R_1, R_2$		1575	1750	1925	$\Omega$
$R_3$		80	100	120	k $\Omega$
$R_4$		22	27	32	k $\Omega$
$C_{line}$	$V_{line} = 0\text{ V}, V_{osc} = 30\text{ mV}, F = 1\text{ MHz}$ CEC to GND with $R_{PU2}$ not connected SCL and SDA to GND with $R_{PU}$ not connected (measured under zero light conditions)		14 24	17 29	pF
$C_{line}^{(1)}$	$V_{line} = 0\text{ V}, V_{osc} = 30\text{ mV}, F = 1\text{ MHz}$ CEC, SCL and SDA to GND with $R_{PU}$ and $R_{PU2}$ grounded (measured under zero light conditions)		10	12	pF

1. This is the line capacitance seen by the data signals in the application conditions

Figure 4. S21(dB) versus frequency

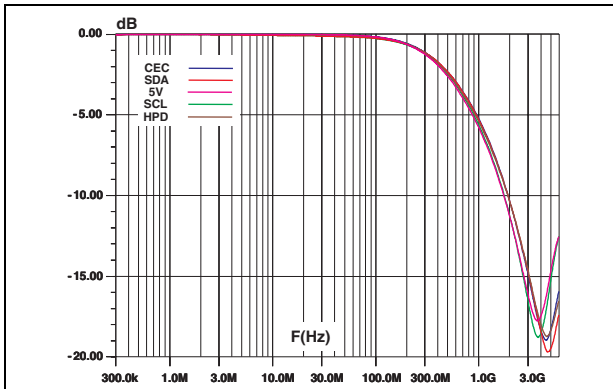

Figure 5. Analog crosstalk measurements

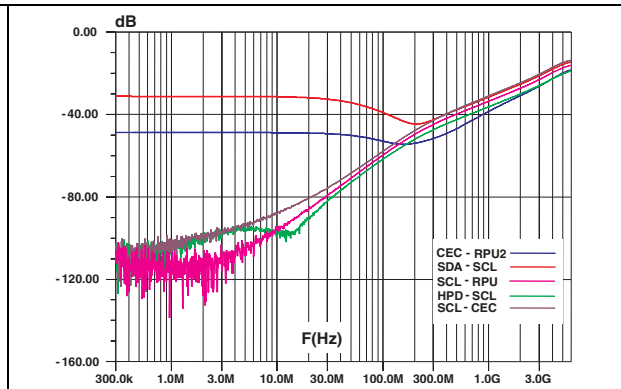

Figure 6. ESD response to IEC 61000-4-2 (+8 kV contact discharge) on CEC line

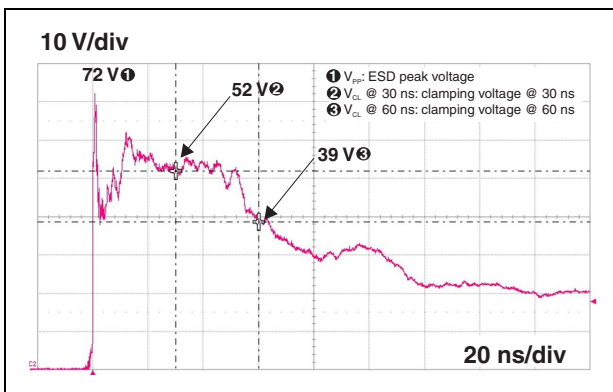

Figure 7. ESD response to IEC 61000-4-2 (-8 kV contact discharge) on CEC line

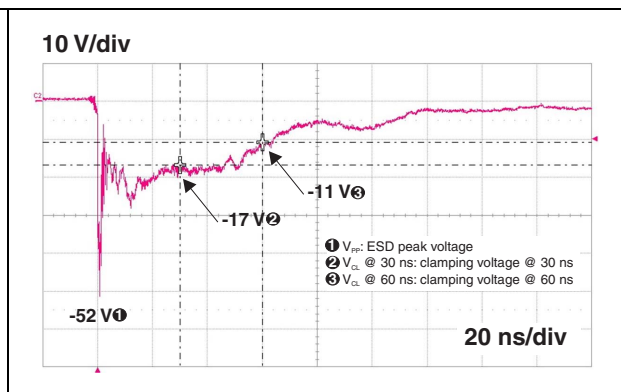

Figure 8. ESD response to IEC 61000-4-2 (+8 kV contact discharge) on SCL line

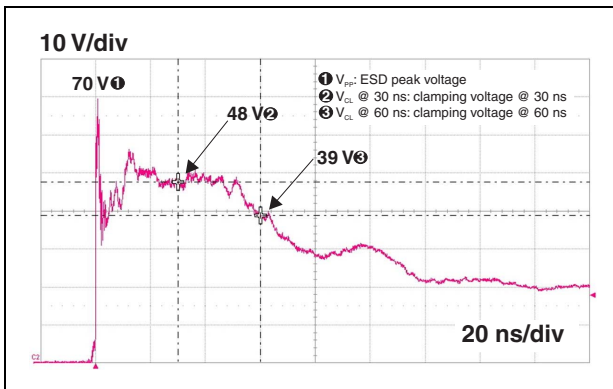

Figure 9. ESD response to IEC 61000-4-2 (-8 kV contact discharge) on SCL line

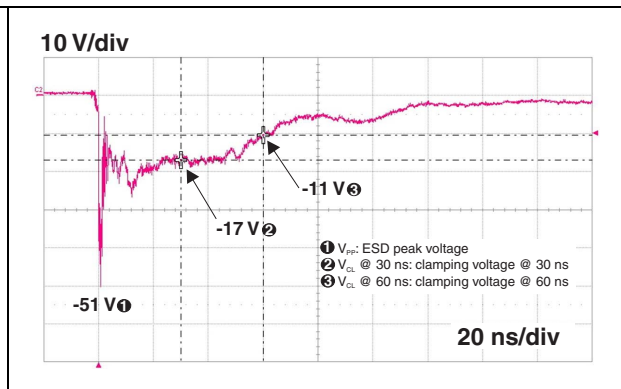

Figure 10. ESD response to IEC 61000-4-2 (+8 kV contact discharge) on SDA line

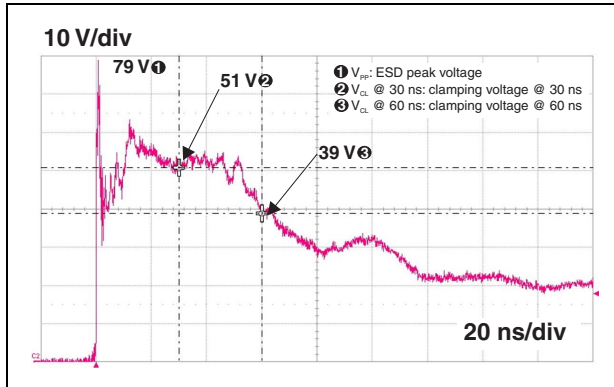

Figure 11. ESD response to IEC 61000-4-2 (-8 kV contact discharge) on SDA line

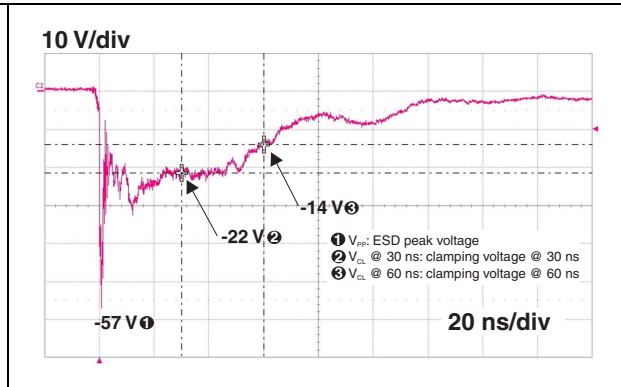

Figure 12. ESD response to IEC 61000-4-2 (+8 kV contact discharge) on HPD line

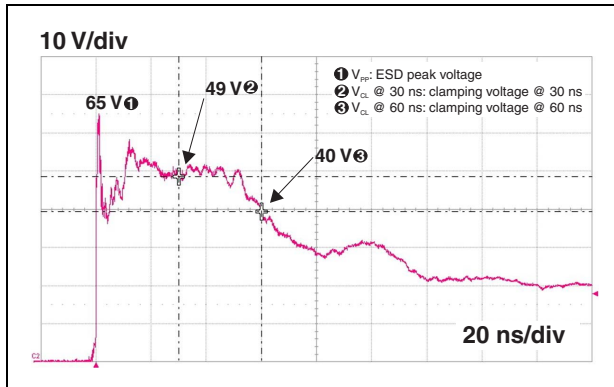

Figure 13. ESD response to IEC 61000-4-2 (-8 kV contact discharge) on HPD line

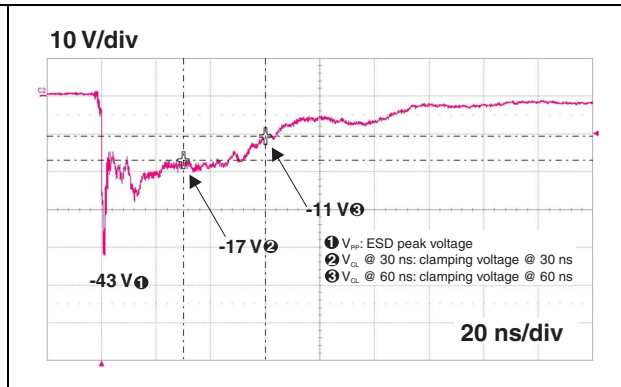

Figure 14. ESD response to IEC 61000-4-2 (+8 kV contact discharge) on 5 V line

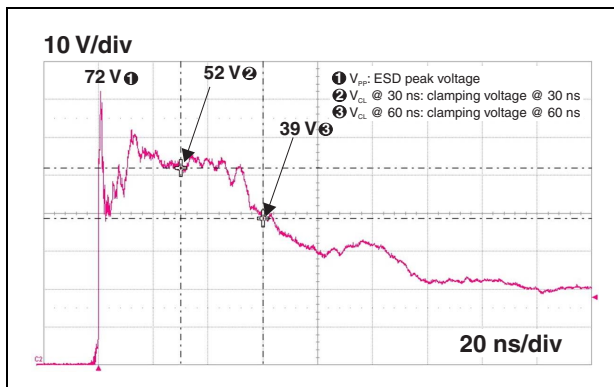
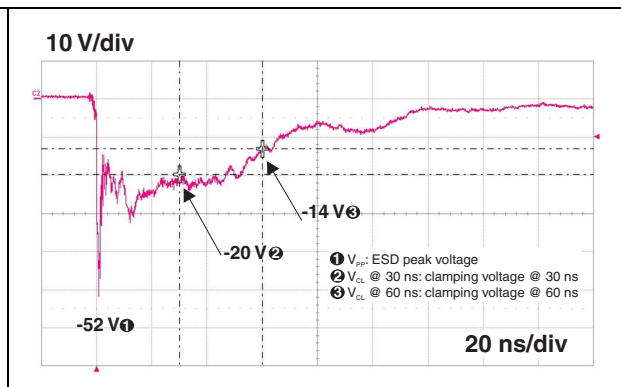
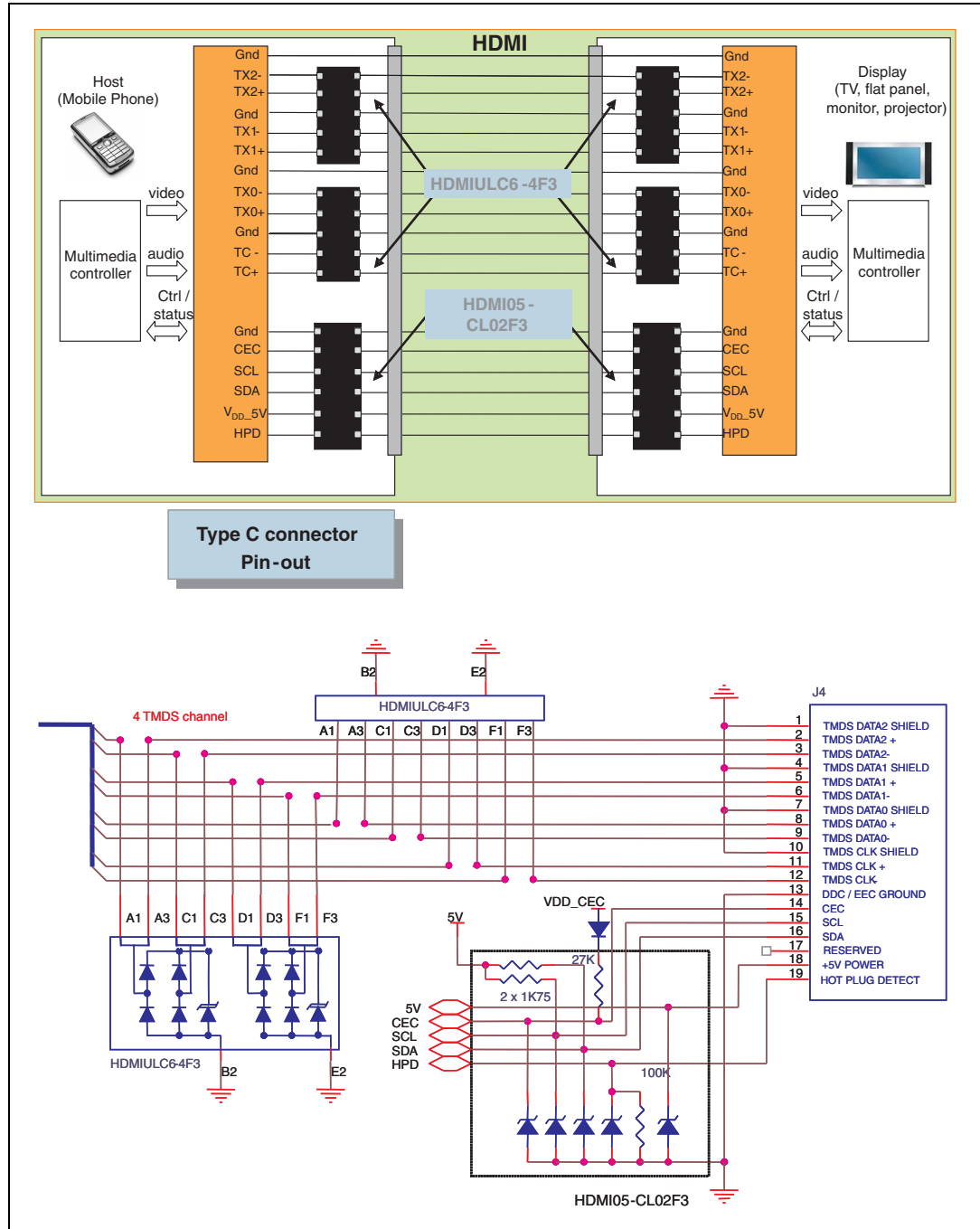

Figure 15. ESD response to IEC 61000-4-2 (-8 kV contact discharge) on 5 V line



## 2 Typical application schematic

Figure 16. Implementation with HDMI



### 3 Ordering information scheme

Figure 17. Ordering information scheme

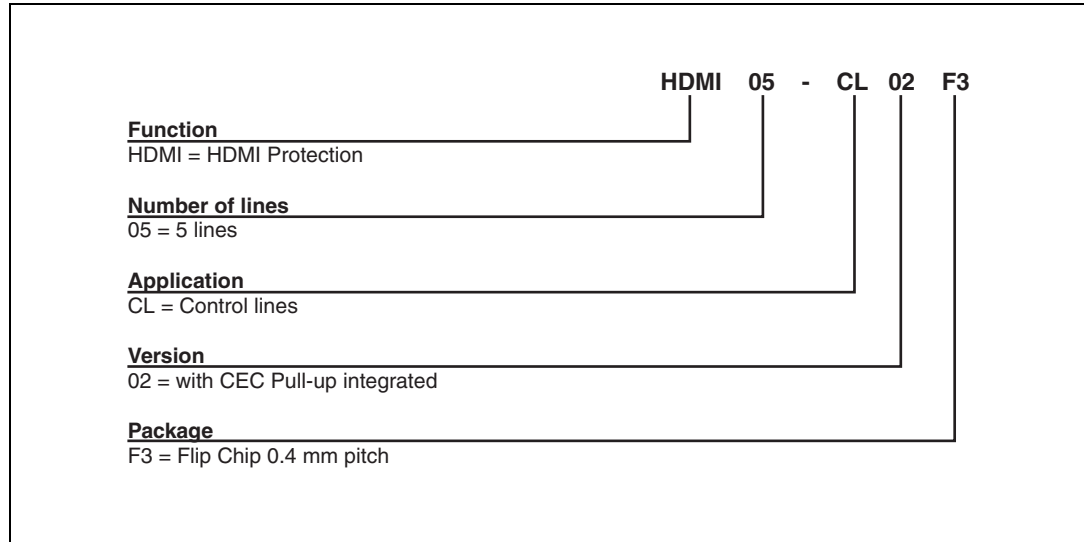

### 4 Package information

In order to meet environmental requirements, ST offers these devices in different grades of ECOPACK® packages, depending on their level of environmental compliance. ECOPACK® specifications, grade definitions and product status are available at: [www.st.com](http://www.st.com). ECOPACK® is an ST trademark.

Figure 18. Flip Chip dimensions

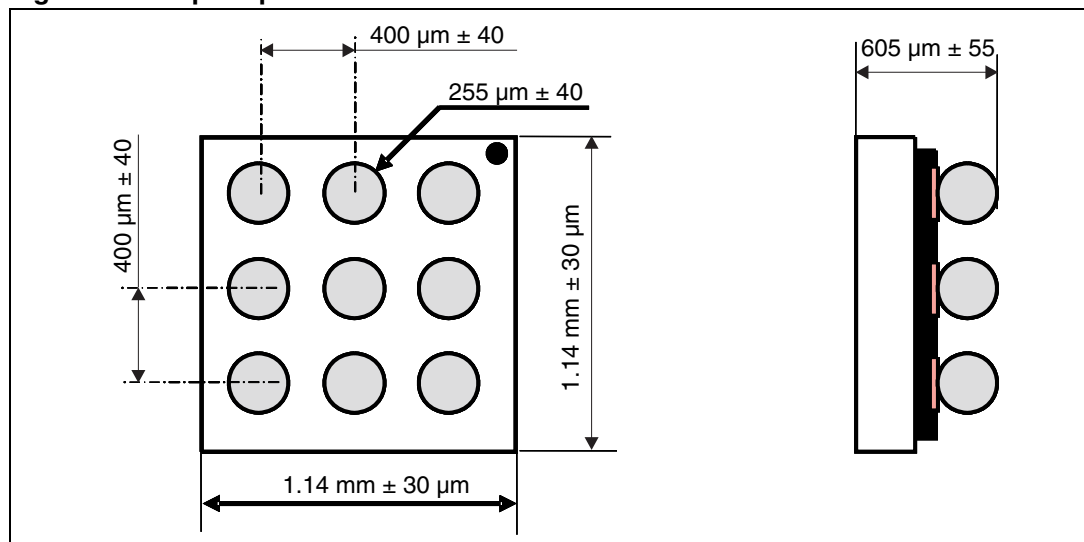

Figure 19. Footprint

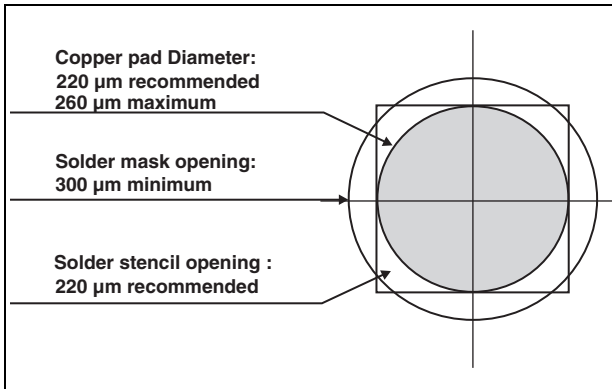

Figure 20. Marking

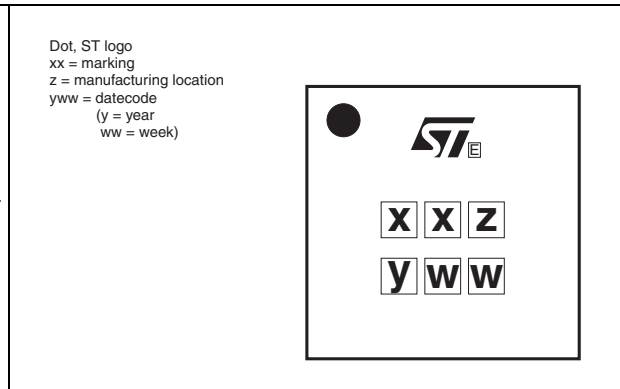
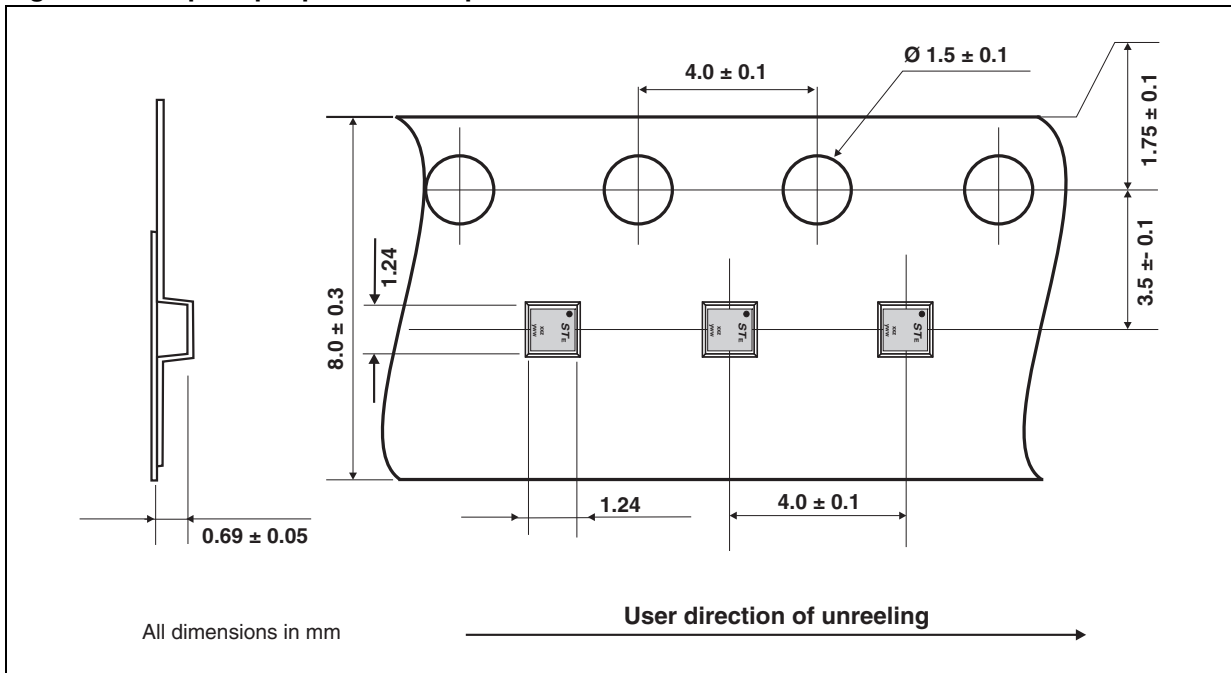

Figure 21. Flip Chip tape and reel specification



## 5 Ordering information

**Table 3. Ordering information**

Order code	Marking	Package	Weight	Base qty	Delivery mode
HDMI05-CL02F3	JG	Flip Chip	1.76 mg	5000	Tape and reel (7")

## 6 Revision history

**Table 4. Document revision history**

Date	Revision	Changes
24-Mar-2009	1	First issue.
07-Apr-2010	2	Updated <a href="#">Figure 18</a> .



**Please Read Carefully:**

Information in this document is provided solely in connection with ST products. STMicroelectronics NV and its subsidiaries ("ST") reserve the right to make changes, corrections, modifications or improvements, to this document, and the products and services described herein at any time, without notice.

All ST products are sold pursuant to ST's terms and conditions of sale.

Purchasers are solely responsible for the choice, selection and use of the ST products and services described herein, and ST assumes no liability whatsoever relating to the choice, selection or use of the ST products and services described herein.

No license, express or implied, by estoppel or otherwise, to any intellectual property rights is granted under this document. If any part of this document refers to any third party products or services it shall not be deemed a license grant by ST for the use of such third party products or services, or any intellectual property contained therein or considered as a warranty covering the use in any manner whatsoever of such third party products or services or any intellectual property contained therein.

**UNLESS OTHERWISE SET FORTH IN ST'S TERMS AND CONDITIONS OF SALE ST DISCLAIMS ANY EXPRESS OR IMPLIED WARRANTY WITH RESPECT TO THE USE AND/OR SALE OF ST PRODUCTS INCLUDING WITHOUT LIMITATION IMPLIED WARRANTIES OF MERCHANTABILITY, FITNESS FOR A PARTICULAR PURPOSE (AND THEIR EQUIVALENTS UNDER THE LAWS OF ANY JURISDICTION), OR INFRINGEMENT OF ANY PATENT, COPYRIGHT OR OTHER INTELLECTUAL PROPERTY RIGHT.**

**UNLESS EXPRESSLY APPROVED IN WRITING BY AN AUTHORIZED ST REPRESENTATIVE, ST PRODUCTS ARE NOT RECOMMENDED, AUTHORIZED OR WARRANTED FOR USE IN MILITARY, AIR CRAFT, SPACE, LIFE SAVING, OR LIFE SUSTAINING APPLICATIONS, NOR IN PRODUCTS OR SYSTEMS WHERE FAILURE OR MALFUNCTION MAY RESULT IN PERSONAL INJURY, DEATH, OR SEVERE PROPERTY OR ENVIRONMENTAL DAMAGE. ST PRODUCTS WHICH ARE NOT SPECIFIED AS "AUTOMOTIVE GRADE" MAY ONLY BE USED IN AUTOMOTIVE APPLICATIONS AT USER'S OWN RISK.**

Resale of ST products with provisions different from the statements and/or technical features set forth in this document shall immediately void any warranty granted by ST for the ST product or service described herein and shall not create or extend in any manner whatsoever, any liability of ST.

ST and the ST logo are trademarks or registered trademarks of ST in various countries.

Information in this document supersedes and replaces all information previously supplied.

The ST logo is a registered trademark of STMicroelectronics. All other names are the property of their respective owners.

© 2010 STMicroelectronics - All rights reserved

STMicroelectronics group of companies

Australia - Belgium - Brazil - Canada - China - Czech Republic - Finland - France - Germany - Hong Kong - India - Israel - Italy - Japan - Malaysia - Malta - Morocco - Philippines - Singapore - Spain - Sweden - Switzerland - United Kingdom - United States of America

[www.st.com](http://www.st.com)

## Данный компонент на территории Российской Федерации

### Вы можете приобрести в компании MosChip.

Для оперативного оформления запроса Вам необходимо перейти по данной ссылке:

<http://moschip.ru/get-element>

Вы можете разместить у нас заказ для любого Вашего проекта, будь то серийное производство или разработка единичного прибора.

В нашем ассортименте представлены ведущие мировые производители активных и пассивных электронных компонентов.

Нашей специализацией является поставка электронной компонентной базы двойного назначения, продукции таких производителей как XILINX, Intel (ex.ALTERA), Vicor, Microchip, Texas Instruments, Analog Devices, Mini-Circuits, Amphenol, Glenair.

Сотрудничество с глобальными дистрибьюторами электронных компонентов, предоставляет возможность заказывать и получать с международных складов практически любой перечень компонентов в оптимальные для Вас сроки.

На всех этапах разработки и производства наши партнеры могут получить квалифицированную поддержку опытных инженеров.

Система менеджмента качества компании отвечает требованиям в соответствии с ГОСТ Р ИСО 9001, ГОСТ РВ 0015-002 и ЭС РД 009

### Офис по работе с юридическими лицами:

105318, г.Москва, ул.Щербаковская д.3, офис 1107, 1118, ДЦ «Щербаковский»

Телефон: +7 495 668-12-70 (многоканальный)

Факс: +7 495 668-12-70 (доб.304)

E-mail: [info@moschip.ru](mailto:info@moschip.ru)

Skype отдела продаж:

moschip.ru

moschip.ru\_4

moschip.ru\_6

moschip.ru\_9