

SURFACE MOUNT LED RED, 1204 PACKAGE

BIVAR

SM1204SRC

- ◆ Industry Standard 1204 Package
- ◆ RoHS Compliant
- ◆ Right Angle Mounting
- ◆ Water Clear Lens
- ◆ Wide Viewing Angle
- ◆ Ideal for Status Indication and Display



Bivar Surface Mount 1204 package LED may be used in nearly any lighting or indication application. The right angle package is ideal for small scale applications such as edge lighting or general indication. Low power consumption and excellent long life reliability are ideal for battery powered equipment. Wide variety of wavelength and intensity combinations are available to meet any illumination need. Bivar offers water clear LED lens for maximum luminous intensity. The SM1204 LED is packaged in standard tape and reels for pick and place assemblies.

Part Number	Material	Emitted Color	Peak Wavelength λ_p (nm) TYP.	Lens Appearance	Luminous Intensity (mcd) TYP.	Viewing Angle
SM1204SRC	AlGaInP	RED	655	Water Clear	48	110°

Outline Dimensions



Outline Drawings Notes:

1. All dimensions are in inches [millimeters].
2. Standard tolerance: ± 0.010 " unless otherwise noted.



Bivar reserves the right to make changes at any time without notice.

SURFACE MOUNT LED RED, 1204 PACKAGE



Absolute Maximum Ratings

$T_A = 25^\circ\text{C}$ unless otherwise noted

Power Dissipation	78 mW
Forward Current (DC)	30 mA
Peak Forward Current ¹	100 mA
Reverse Voltage	5 V
Operating Temperature Range	-30 ~ +80°C
Storage Temperature Range	-40 ~ +85°C
Lead Soldering Temperature (3 mm from the base of the epoxy bulb) ²	260°C

Notes: 1. 10% Duty Cycle, Pulse Width \leq 0.1 msec. 2. Solder time less than 5 seconds at temperature extreme.

Electrical / Optical Characteristics

$T_A = 25^\circ\text{C}$ & $I_F = 20$ mA unless otherwise noted

Part Number	Forward Voltage (V) ¹			Recommend Forward Current (mA)			Reverse Current (μA)	Dominant Wavelength (nm) ²			Luminous Intensity I_v (mcd)			Viewing Angle $2\theta_{1/2}$ (deg)
	MIN	TYP	MAX	MIN	TYP	MAX	MAX	MIN	TYP	MAX	MIN	TYP	MAX	TYP
SM1204SRC	/	2.1	2.6	/	20	/	10	/	640	/	20	48	/	110

Notes: 1. Tolerance of forward voltage : $\pm 0.05\text{V}$. 2. Tolerance of dominant wavelength : $\pm 1.0\text{nm}$.

Bivar reserves the right to make changes at any time without notice.

Typical Electrical / Optical Characteristics

$T_A = 25^\circ\text{C}$ unless otherwise noted

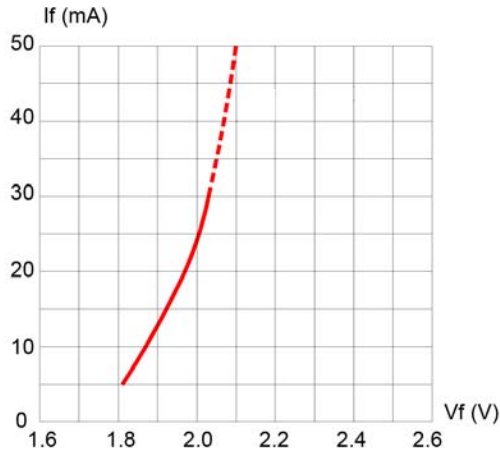

Fig. 1 Forward Current vs. Forward Voltage

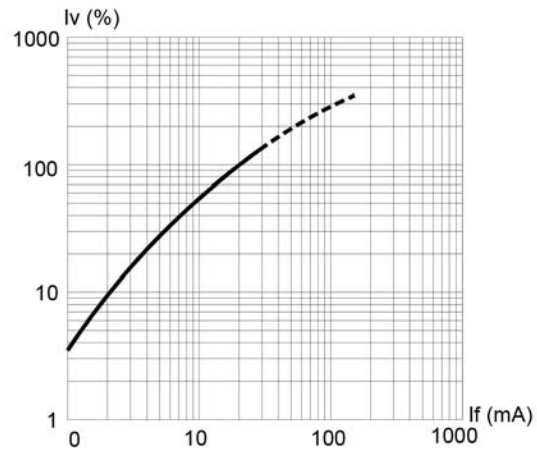

Fig. 2 Relative Luminous Intensity vs. Forward Current

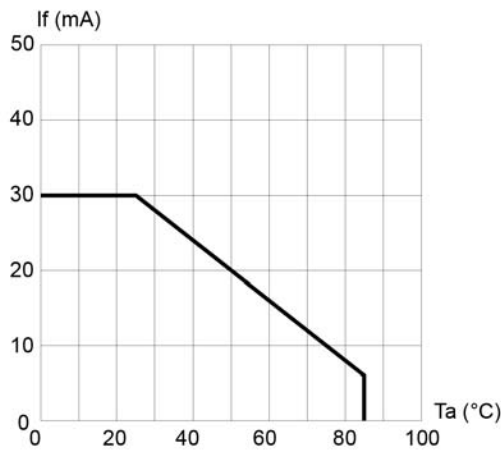

Fig. 3 Forward Current vs. Temperature

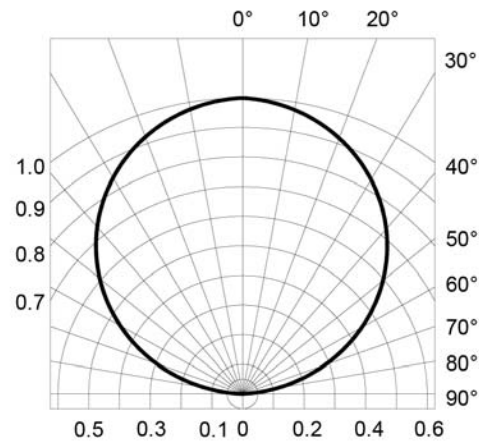

Fig. 4 Directivity Radiation Diagram

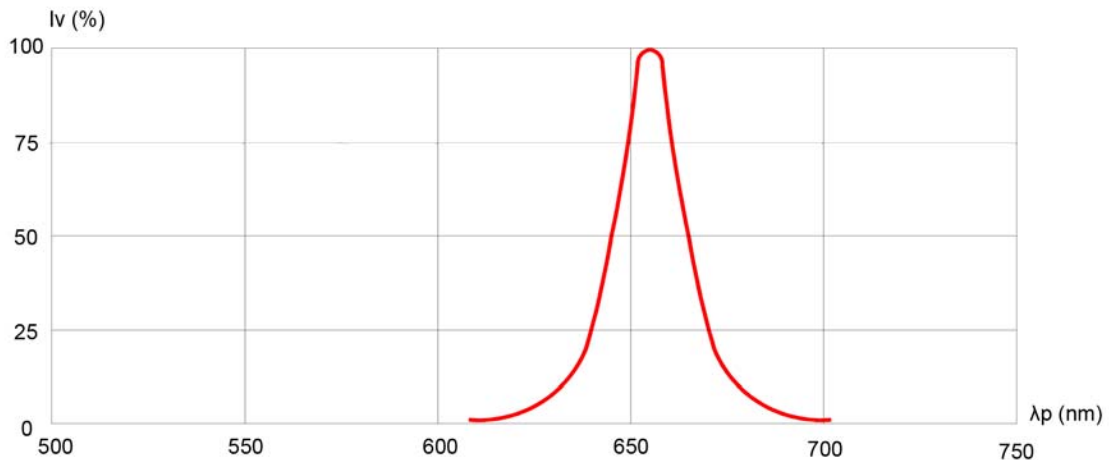

Fig. 5 Relative Luminous Intensity vs. Peak Wavelength

Bivar reserves the right to make changes at any time without notice.

SURFACE MOUNT LED RED, 1204 PACKAGE



Recommended Soldering Conditions

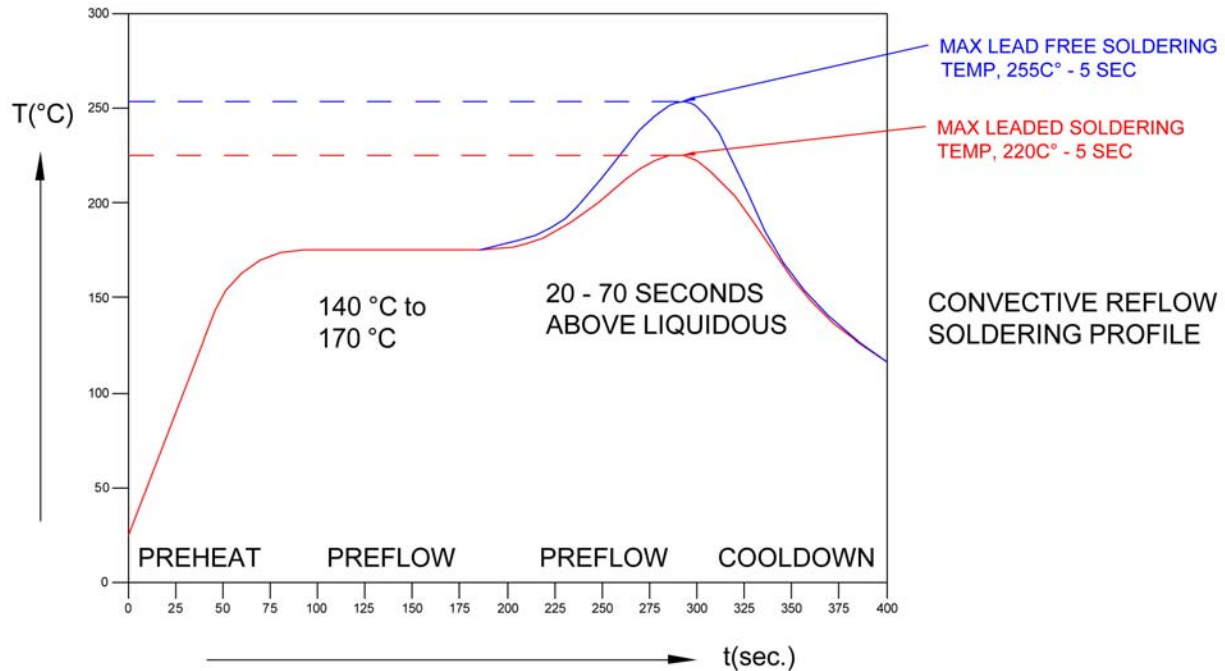

Tape and Reel Dimensions

Note: 3000 PCS/Reel

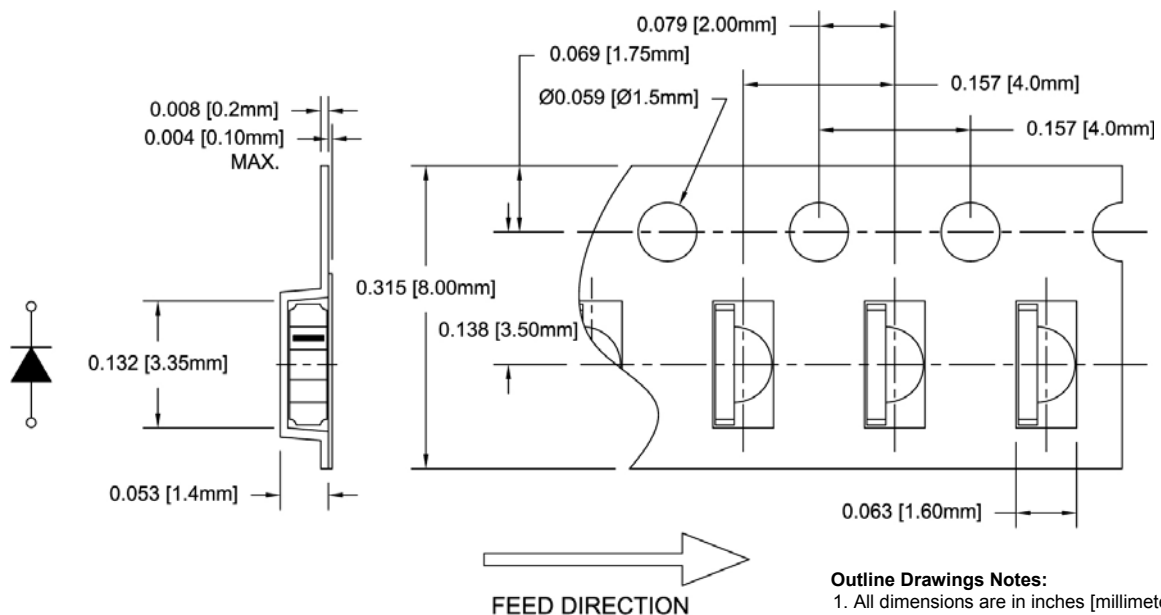

Outline Drawings Notes:

1. All dimensions are in inches [millimeters].
2. Standard tolerance: $\pm 0.010''$ unless otherwise noted.

Bivar reserves the right to make changes at any time without notice.

SURFACE MOUNT LED RED, 1204 PACKAGE

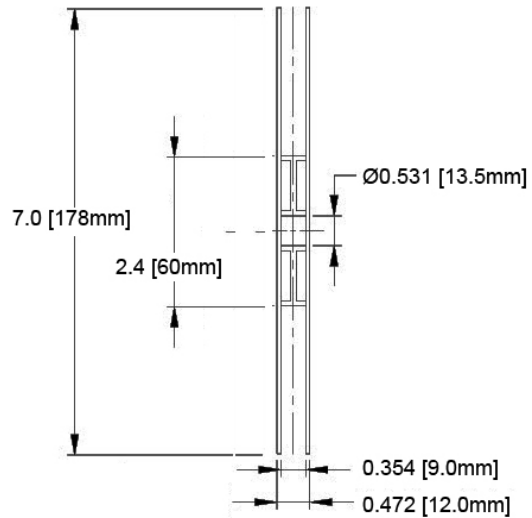
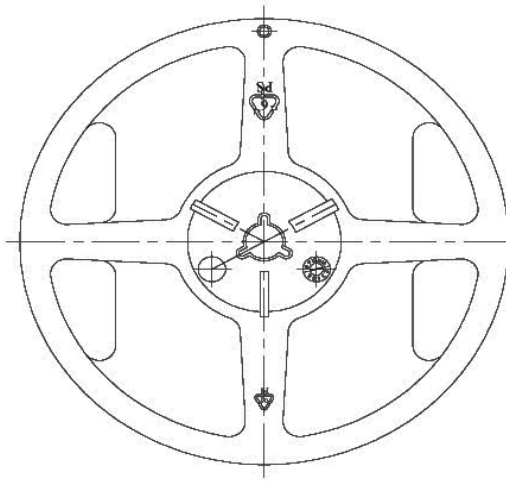

Outline Drawings Notes:

1. All dimensions are in inches [millimeters].
2. Standard tolerance unless otherwise noted: X.XXX ± 0.010"
X.X ± 0.1"

Packaging and Labeling Plan

Note: 1 Reel / Bag

Vacuum and Heat Sealed
Clear AntiStatic Poly Bag

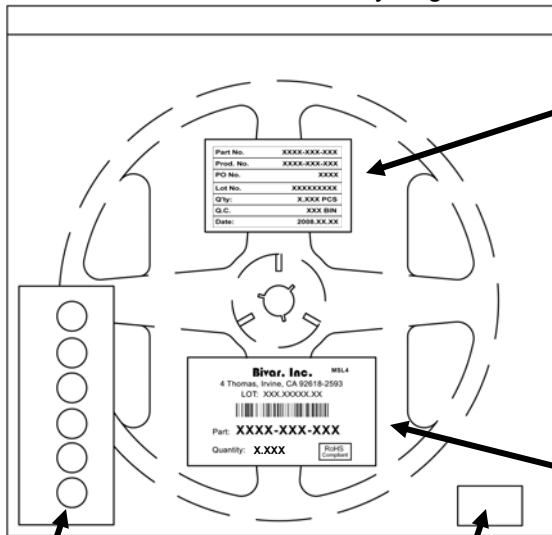

Humidity Indicator
Card

Desiccant
Card

Part No.	XXXX-XXX-XXX
Prod. No.	XXXX-XXX-XXX
PO No.	XXXX
Lot No.	XXXXXXXXXX
Q'ty:	X.XXX PCS
Q.C.	XXX BIN
Date:	2008.XX.XX

Internal Quality Control

Bivar, Inc. MSL4

4 Thomas, Irvine, CA 92618-2593
LOT: XXX.XXXXX.XX



Part: **XXXX-XXX-XXX**

Quantity: **X.XXX**

RoHS
Compliant

Bivar Standard Packaging Label

Bivar reserves the right to make changes at any time without notice.

Данный компонент на территории Российской Федерации

Вы можете приобрести в компании MosChip.

Для оперативного оформления запроса Вам необходимо перейти по данной ссылке:

<http://moschip.ru/get-element>

Вы можете разместить у нас заказ для любого Вашего проекта, будь то серийное производство или разработка единичного прибора.

В нашем ассортименте представлены ведущие мировые производители активных и пассивных электронных компонентов.

Нашей специализацией является поставка электронной компонентной базы двойного назначения, продукции таких производителей как XILINX, Intel (ex.ALTERA), Vicor, Microchip, Texas Instruments, Analog Devices, Mini-Circuits, Amphenol, Glenair.

Сотрудничество с глобальными дистрибьюторами электронных компонентов, предоставляет возможность заказывать и получать с международных складов практически любой перечень компонентов в оптимальные для Вас сроки.

На всех этапах разработки и производства наши партнеры могут получить квалифицированную поддержку опытных инженеров.

Система менеджмента качества компании отвечает требованиям в соответствии с ГОСТ Р ИСО 9001, ГОСТ РВ 0015-002 и ЭС РД 009

Офис по работе с юридическими лицами:

105318, г.Москва, ул.Щербаковская д.3, офис 1107, 1118, ДЦ «Щербаковский»

Телефон: +7 495 668-12-70 (многоканальный)

Факс: +7 495 668-12-70 (доб.304)

E-mail: info@moschip.ru

Skype отдела продаж:

moschip.ru

moschip.ru_4

moschip.ru_6

moschip.ru_9