

### FEATURES

**Low supply current: 250  $\mu$ A/amp maximum**  
**High slew rate: 9 V/ $\mu$ s**  
**Bandwidth: 3.5 MHz typical**  
**Low offset voltage: 1 mV maximum @ 25°C**  
**Low input bias current: 20 pA maximum @ 25°C**  
**CMRR: 90 dB typical**  
**Fast settling time**  
**Unity-gain stable**

### APPLICATIONS

**Portable telecommunications**  
**Low power industrial and instrumentation**  
**Loop filters**  
**Active and precision filters**  
**Integrators**  
**Strain gauge amplifiers**  
**Portable medical instrumentation**  
**Supply current monitoring**

### GENERAL DESCRIPTION

The AD8682 and AD8684 are dual and quad low power, precision (1 mV) JFET amplifiers featuring excellent speed at low supply currents. The slew rate is typically 9 V/ $\mu$ s with a supply current under 250  $\mu$ A per amplifier. These unity-gain stable amplifiers have a typical gain bandwidth of 3.5 MHz. The JFET input stage ensures bias current is typically a few picoamps and below 125 pA maximum over the full temperature operating range.

### PIN CONFIGURATIONS



Figure 1. 8-Lead SOIC\_N and 8-Lead MSOP



Figure 2. 14-Lead SOIC\_N and 14-Lead TSSOP

The devices are ideal for portable, low power applications, especially with high source impedance. The devices are unity-gain stable and can drive higher capacity loads ( $G = 1$ , noninverting), as an example of their excellent dynamic response over a wide range of conditions, delivering dc precision performance at low quiescent currents.

#### Rev. B

Information furnished by Analog Devices is believed to be accurate and reliable. However, no responsibility is assumed by Analog Devices for its use, nor for any infringements of patents or other rights of third parties that may result from its use. Specifications subject to change without notice. No license is granted by implication or otherwise under any patent or patent rights of Analog Devices. Trademarks and registered trademarks are the property of their respective owners.

**TABLE OF CONTENTS**

Features .....	1	ESD Caution.....	4
Applications.....	1	Typical Performance Characteristics .....	5
Pin Configurations .....	1	Applications Information .....	10
General Description .....	1	High-Side Signal Conditioning .....	10
Revision History .....	2	Phase Inversion.....	10
Specifications.....	3	Active Filters .....	10
Electrical Characteristics .....	3	Programmable State Variable Filter .....	11
Absolute Maximum Ratings.....	4	Outline Dimensions .....	12
Thermal Resistance .....	4	Ordering Guide .....	14

**REVISION HISTORY**

**7/08—Rev. A to Rev. B**

Changes to Phase Inversion Section .....	10
Deleted Figure 33.....	10
Added Figure 33 and Figure 34.....	10
Updated Outline Dimensions .....	12

**7/07—Rev. 0 to Rev. A**

Change to Figure 21 .....	8
Change to Figure 31 .....	9

**10/06—Revision 0: Initial Version**

# SPECIFICATIONS

## ELECTRICAL CHARACTERISTICS

$V_S = \pm 15.0$  V,  $T_A = 25^\circ\text{C}$ ,  $V_{CM} = 0$  V, unless otherwise noted.

Table 1.

Parameter	Symbol	Conditions	Min	Typ	Max	Unit
INPUT CHARACTERISTICS						
Offset Voltage AD8682	$V_{OS}$	$+25^\circ\text{C} \leq T_A \leq +85^\circ\text{C}$		0.35	1	mV
		$-40^\circ\text{C} \leq T_A \leq +25^\circ\text{C}$			2.5	mV
AD8684		$+25^\circ\text{C} \leq T_A \leq +85^\circ\text{C}$			3	mV
		$-40^\circ\text{C} \leq T_A \leq +25^\circ\text{C}$			3.5	mV
Input Bias Current	$I_B$	$+25^\circ\text{C} \leq T_A \leq +85^\circ\text{C}$			4	mV
		$-40^\circ\text{C} \leq T_A \leq +25^\circ\text{C}$		6	20	pA
Input Offset Current	$I_{OS}$	$+25^\circ\text{C} \leq T_A \leq +85^\circ\text{C}$			125	pA
		$-40^\circ\text{C} \leq T_A \leq +25^\circ\text{C}$			20	pA
Input Voltage Range Common-Mode Rejection Ratio	CMRR	$-11\text{ V} \leq V_{CM} \leq +15\text{ V}, -40^\circ\text{C} \leq T_A \leq +85^\circ\text{C}$	-11		+15	V
			70	90		dB
Large Signal Voltage Gain	$A_{VO}$	$R_L = 10\text{ k}\Omega$	20			V/mV
		$R_L = 10\text{ k}\Omega, -40^\circ\text{C} \leq T_A \leq +85^\circ\text{C}$	15			V/mV
Offset Voltage Drift	$\Delta V_{OS}/\Delta T$			10		$\mu\text{V}/^\circ\text{C}$
Bias Current Drift	$\Delta I_B/\Delta T$			8		$\text{pA}/^\circ\text{C}$
OUTPUT CHARACTERISTICS						
Output Voltage High	$V_{OH}$	$R_L = 10\text{ k}\Omega$	13.5	13.9		V
Output Voltage Low	$V_{OL}$	$R_L = 10\text{ k}\Omega$		-13.9	-13.5	V
Short-Circuit Limit	$I_{SC}$	Source	3	10		mA
		Sink		-12	-8	mA
Open-Loop Output Impedance	$Z_{OUT}$	$f = 1\text{ MHz}$		200		$\Omega$
POWER SUPPLY						
Power Supply Rejection Ratio	PSRR	$V_S = \pm 4.5\text{ V to } \pm 18\text{ V}, -40^\circ\text{C} \leq T_A \leq +85^\circ\text{C}$	92	114		dB
Supply Current/Amplifier	$I_{SY}$	$V_O = 0\text{ V}, -40^\circ\text{C} \leq T_A \leq +85^\circ\text{C}$		210	250	$\mu\text{A}$
Supply Voltage Range	$V_S$		$\pm 4.5$		$\pm 18$	V
DYNAMIC PERFORMANCE						
Slew Rate	SR	$R_L = 10\text{ k}\Omega$	7	9		$\text{V}/\mu\text{s}$
Full-Power Bandwidth	$BW_P$	1% distortion		125		kHz
Settling Time	$t_S$	To 0.01%		1.6		$\mu\text{s}$
Gain Bandwidth Product	GBP			3.5		MHz
Phase Margin	$\phi_M$			55		Degrees
NOISE PERFORMANCE						
Voltage Noise	$e_n$ p-p	0.1 Hz to 10 Hz		1.3		$\mu\text{V p-p}$
Voltage Noise Density	$e_n$	$f = 1\text{ kHz}$		36		$\text{nV}/\sqrt{\text{Hz}}$
Current Noise Density	$i_n$			0.01		$\text{pA}/\sqrt{\text{Hz}}$

## ABSOLUTE MAXIMUM RATINGS

Table 2.

Parameter	Rating
Supply Voltage	±18 V
Input Voltage	±18 V
Differential Input Voltage <sup>1</sup>	36 V
Output Short-Circuit Duration	Indefinite
Storage Temperature Range	−65°C to +150°C
Operating Temperature Range	−40°C to +85°C
Junction Temperature Range	−65°C to +150°C
Lead Temperature (Soldering, 60 sec)	300°C

<sup>1</sup> For supply voltages less than ±18 V, the absolute maximum input voltage is equal to the supply voltage.

Stresses above those listed under Absolute Maximum Ratings may cause permanent damage to the device. This is a stress rating only; functional operation of the device at these or any other conditions above those indicated in the operational section of this specification is not implied. Exposure to absolute maximum rating conditions for extended periods may affect device reliability.

## THERMAL RESISTANCE

Table 3.

Package Type	$\theta_{JA}$	$\theta_{JC}$	Unit
8-Lead MSOP [RM-8]	210	45	°C/W
8-Lead SOIC_N [R-8]	158	43	°C/W
14-Lead TSSOP [RU-14]	180	35	°C/W
14-Lead SOIC_N [R-14]	120	36	°C/W

## ESD CAUTION



### ESD (electrostatic discharge) sensitive device.

Charged devices and circuit boards can discharge without detection. Although this product features patented or proprietary protection circuitry, damage may occur on devices subjected to high energy ESD. Therefore, proper ESD precautions should be taken to avoid performance degradation or loss of functionality.

### TYPICAL PERFORMANCE CHARACTERISTICS

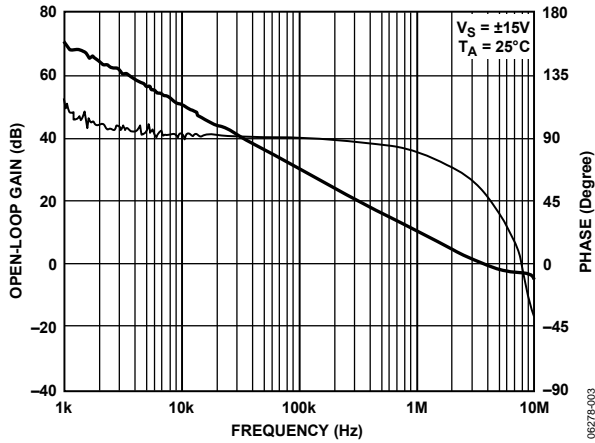

Figure 3. AD8682 Open-Loop Gain and Phase vs. Frequency

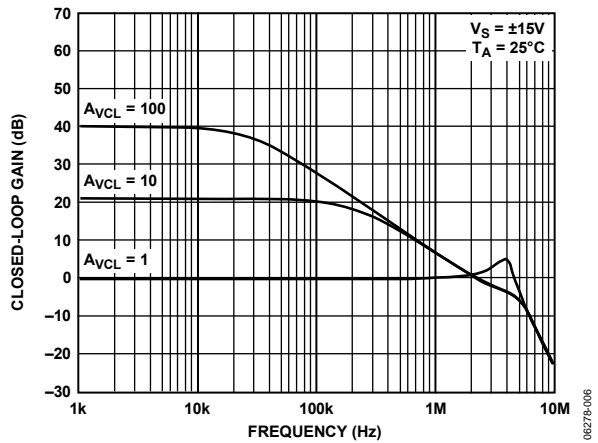

Figure 6. AD8682 Closed-Loop Gain vs. Frequency



Figure 4. AD8682 Open-Loop Gain vs. Temperature

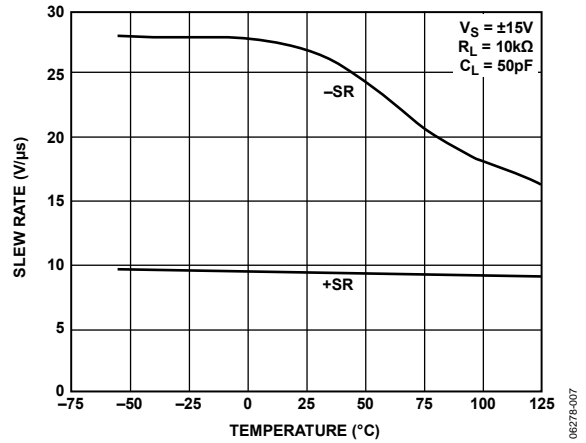

Figure 7. Slew Rate vs. Temperature



Figure 5. Small Signal Overshoot vs. Load Capacitance



Figure 8. AD8682 Input Bias Current vs. Temperature

# AD8682/AD8684



Figure 9. Voltage Noise Density vs. Frequency

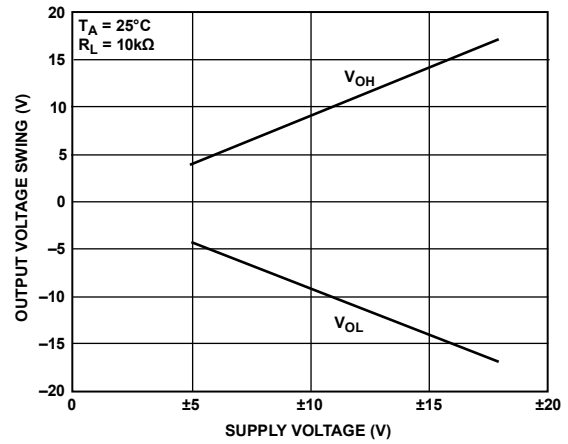

Figure 12. Output Voltage Swing vs. Supply Voltage



Figure 10. Input Bias Current vs. Common-Mode Voltage

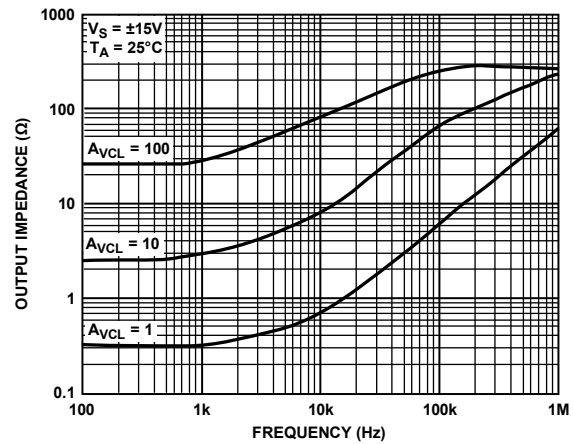

Figure 13. Closed-Loop Output Impedance vs. Frequency



Figure 11. AD8682 Supply Current vs. Supply Voltage

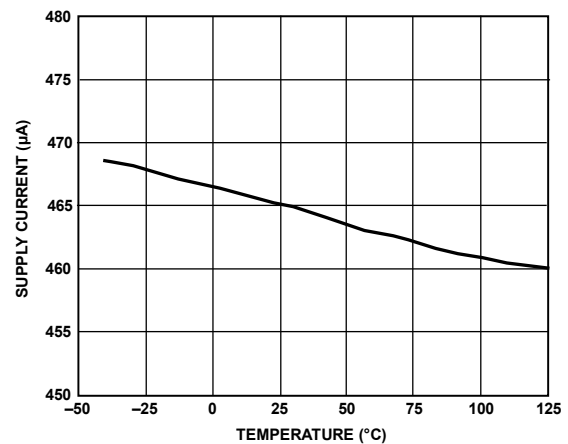

Figure 14. AD8682 Supply Current vs. Temperature



Figure 15. Absolute Output Voltage vs. Load Resistance

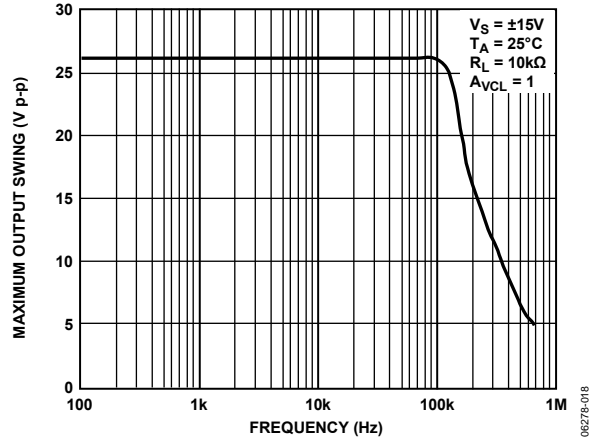

Figure 18. Maximum Output Swing vs. Frequency



Figure 16. AD8682 PSRR vs. Frequency

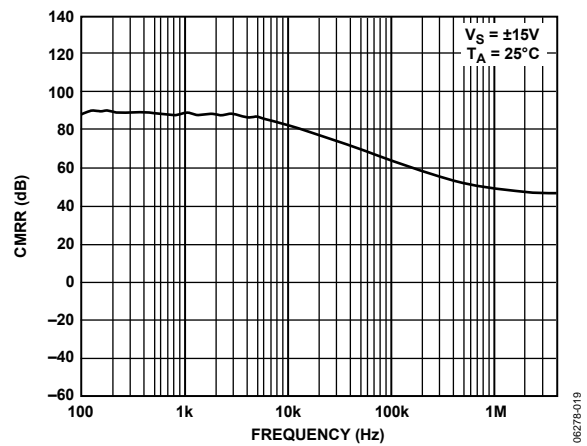

Figure 19. AD8682 CMRR vs. Frequency



Figure 17. AD8682 Short-Circuit Current vs. Temperature

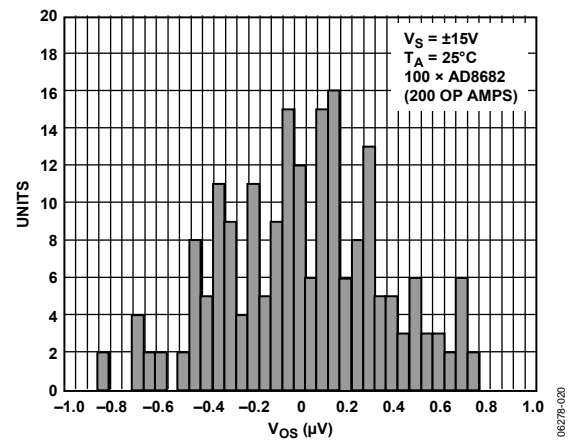

Figure 20. AD8682 VOS Distribution

# AD8682/AD8684



Figure 21. AD8682 TCvos Distribution SOIC\_N Package



Figure 24. AD8684 Input Bias Current vs. Temperature



Figure 22. AD8684 Open-Loop Gain vs. Temperature



Figure 25. AD8684 Relative Supply Current vs. Supply Voltage



Figure 23. AD8684 Closed-Loop Gain vs. Frequency



Figure 26. AD8684 Supply Current vs. Temperature



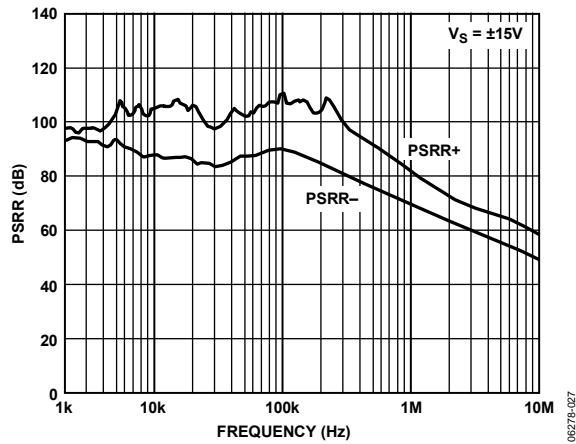

Figure 27. AD8684 PSRR vs. Frequency

06278-027

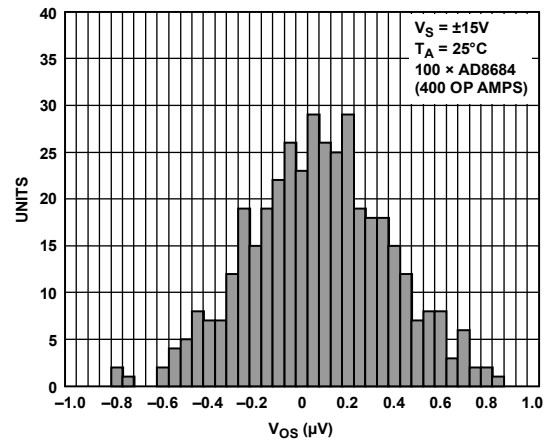

Figure 30. AD8684 VOS Distribution Package

06278-030



Figure 28. AD8684 Short-Circuit Current vs. Temperature

06278-028



Figure 31. AD8684 TCVOS Distribution Package

06278-031

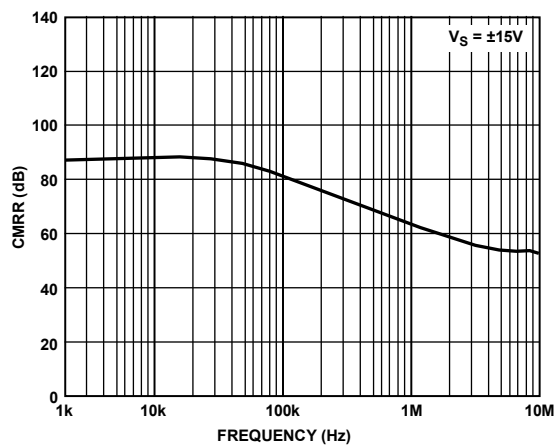

Figure 29. AD8684 CMRR vs. Frequency

06278-029

## APPLICATIONS INFORMATION

The AD8682 and AD8684 are dual and quad JFET op amps that are optimized for high speed at low power. This combination makes these amplifiers excellent choices for battery-powered or low power applications that require above average performance. Applications benefiting from this performance combination include telecommunications, geophysical exploration, portable medical equipment, and navigational instrumentation.

### HIGH-SIDE SIGNAL CONDITIONING

There are many applications requiring the sensing of signals near the positive rail. The AD8682 and the AD8684 were tested and are guaranteed over a common-mode range ( $-11\text{ V} \leq V_{CM} \leq +15\text{ V}$ ) that includes the positive supply.

The AD8682/AD8684 are commonly used in the sensing of power supply currents and in current sensing applications, such as the partial circuit shown in Figure 32. In this circuit, the voltage drop across a low value resistor, such as the  $0.1\ \Omega$  shown here, is amplified and compared to  $7.5\text{ V}$ . The output can then be used for current limiting.



Figure 32. High-Side Signal Conditioning

### PHASE INVERSION

Most JFET input amplifiers invert the phase of the input signal if either input exceeds the input common-mode range. For the AD8682/AD8684, a negative signal in excess of  $11\text{ V}$  causes phase inversion. This is caused by saturation of the input stage leading to the forward-biasing of a gate-drain diode. Phase reversal in AD8682/AD8684 can be prevented by using Schottky diodes to clamp the input terminals to each other and to the supplies. In the simple buffer circuit below, D1 protects the op amp against phase reversal. R1, D2, and D3 limit the input

current when the input exceeds the supply rail. The resistor should be selected to limit the amount of input current below the absolute maximum rating.

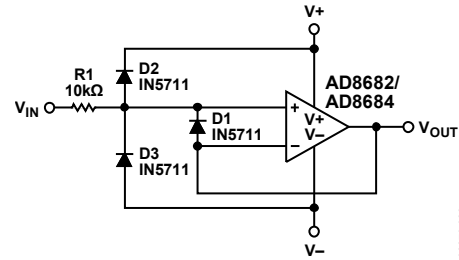

Figure 33. Phase Reversal Solution Circuit



Figure 34. No Phase Reversal

### ACTIVE FILTERS

The wide bandwidth and high slew rates of the AD8682/AD8684 make either one an excellent choice for many filter applications. There are many active filter configurations, but the four most popular configurations are: Butterworth, elliptic, Bessel, and Chebyshev. Each type has a response that is optimized for a given characteristic, as shown in Table 4.

Table 4.

Type	Selectivity	Overshoot	Phase	Amplitude (Pass Band)	Amplitude (Stop Band)
Butterworth	Moderate	Good	Nonlinear	Maximum flat	Equal ripple
Chebyshev	Good	Moderate		Equal ripple	
Elliptic	Best	Poor	Equal ripple		
Bessel (Thompson)	Poor	Best	Linear		



OUTLINE DIMENSIONS



COMPLIANT TO JEDEC STANDARDS MS-012-AA  
 CONTROLLING DIMENSIONS ARE IN MILLIMETERS; INCH DIMENSIONS  
 (IN PARENTHESES) ARE ROUNDED-OFF MILLIMETER EQUIVALENTS FOR  
 REFERENCE ONLY AND ARE NOT APPROPRIATE FOR USE IN DESIGN.

Figure 36. 8-Lead Standard Small Outline Package [SOIC\_N]  
 Narrow Body  
 (R-8)  
 Dimensions shown in millimeters and (inches)

012-807-A

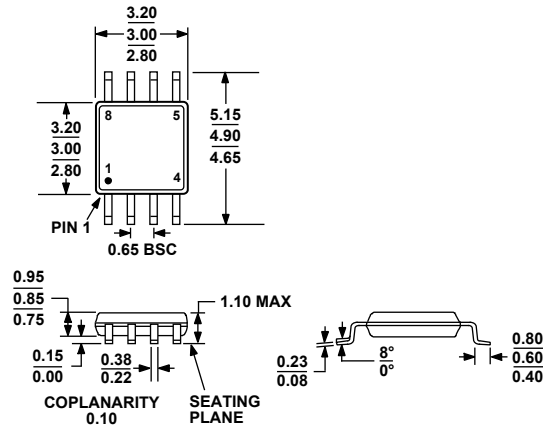

COMPLIANT TO JEDEC STANDARDS MO-187-AA  
 Figure 37. 8-Lead Mini Small Outline Package [MSOP]  
 (RM-8)  
 Dimensions shown in millimeters

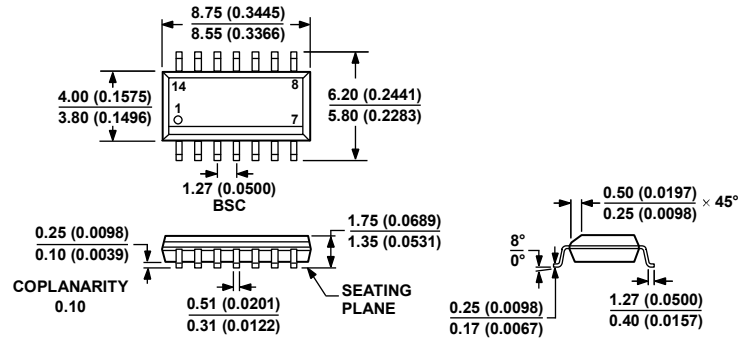

COMPLIANT TO JEDEC STANDARDS MS-012-AB  
 CONTROLLING DIMENSIONS ARE IN MILLIMETERS; INCH DIMENSIONS  
 (IN PARENTHESES) ARE ROUNDED-OFF MILLIMETER EQUIVALENTS FOR  
 REFERENCE ONLY AND ARE NOT APPROPRIATE FOR USE IN DESIGN.

Figure 38. 14-Lead Standard Small Outline Package [SOIC\_N]  
 Narrow Body  
 (R-14)

Dimensions shown in millimeters and (inches)

060606-A

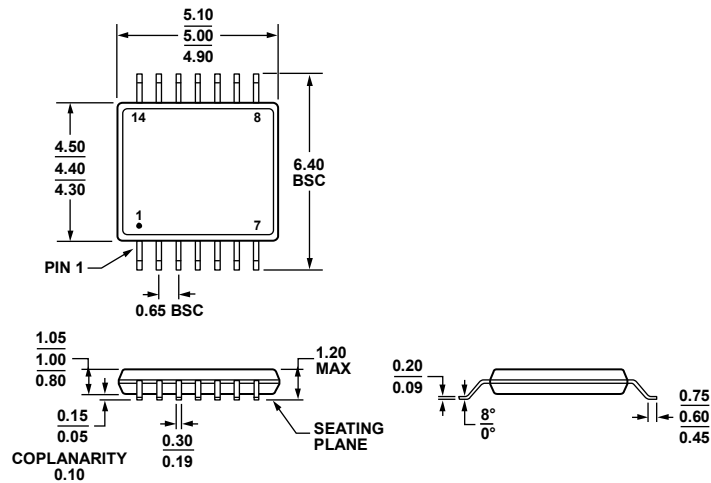

COMPLIANT TO JEDEC STANDARDS MO-153-AB-1

Figure 39. 14-Lead Thin Shrink Small Outline Package [TSSOP]  
 (RU-14)

Dimensions shown in millimeters

061906-A

# AD8682/AD8684

## ORDERING GUIDE

Model	Temperature Range	Package Description	Package Option	Branding
AD8682ARZ <sup>1</sup>	-40°C to +85°C	8-Lead SOIC_N	R-8	
AD8682ARZ-REEL <sup>1</sup>	-40°C to +85°C	8-Lead SOIC_N	R-8	
AD8682ARZ-REEL7 <sup>1</sup>	-40°C to +85°C	8-Lead SOIC_N	R-8	
AD8682ARMZ-R2 <sup>1</sup>	-40°C to +85°C	8-Lead MSOP	RM-8	A1K
AD8682ARMZ-REEL <sup>1</sup>	-40°C to +85°C	8-Lead MSOP	RM-8	A1K
AD8684ARZ <sup>1</sup>	-40°C to +85°C	14-Lead SOIC_N	R-14	
AD8684ARZ-REEL <sup>1</sup>	-40°C to +85°C	14-Lead SOIC_N	R-14	
AD8684ARZ-REEL7 <sup>1</sup>	-40°C to +85°C	14-Lead SOIC_N	R-14	
AD8684ARUZ <sup>1</sup>	-40°C to +85°C	14-Lead TSSOP	RU-14	
AD8684ARUZ-REEL <sup>1</sup>	-40°C to +85°C	14-Lead TSSOP	RU-14	

<sup>1</sup> Z = RoHS Compliant Part.

**NOTES**

**AD8682/AD8684**

**NOTES**



## Данный компонент на территории Российской Федерации

### Вы можете приобрести в компании MosChip.

Для оперативного оформления запроса Вам необходимо перейти по данной ссылке:

<http://moschip.ru/get-element>

Вы можете разместить у нас заказ для любого Вашего проекта, будь то серийное производство или разработка единичного прибора.

В нашем ассортименте представлены ведущие мировые производители активных и пассивных электронных компонентов.

Нашей специализацией является поставка электронной компонентной базы двойного назначения, продукции таких производителей как XILINX, Intel (ex.ALTERA), Vicor, Microchip, Texas Instruments, Analog Devices, Mini-Circuits, Amphenol, Glenair.

Сотрудничество с глобальными дистрибьюторами электронных компонентов, предоставляет возможность заказывать и получать с международных складов практически любой перечень компонентов в оптимальные для Вас сроки.

На всех этапах разработки и производства наши партнеры могут получить квалифицированную поддержку опытных инженеров.

Система менеджмента качества компании отвечает требованиям в соответствии с ГОСТ Р ИСО 9001, ГОСТ РВ 0015-002 и ЭС РД 009

### Офис по работе с юридическими лицами:

105318, г.Москва, ул.Щербаковская д.3, офис 1107, 1118, ДЦ «Щербаковский»

Телефон: +7 495 668-12-70 (многоканальный)

Факс: +7 495 668-12-70 (доб.304)

E-mail: [info@moschip.ru](mailto:info@moschip.ru)

Skype отдела продаж:

moschip.ru

moschip.ru\_4

moschip.ru\_6

moschip.ru\_9