

Introduction to High Current Card Edge Connectors

Product Facts

- Contacts on .100 [2.54] Centerlines
- Selective gold plating of contacts for high performance at low cost
- Flow solder applications
- Glass-filled polyester housing is 94V-0 rated
- Available in vertical, right-angle or straddle PCB-mount
- Solder tails for wave solder applications
- Compliant press-fit PCB tails for solder-less applications
- 50% to 100% greater current carrying capacity than traditional card edge connectors
- Accepts double sided PC boards, .054-.070 [1.27-1.78] thick
- Recognized under the Component Program of Underwriters Laboratories Inc., File No. E28476
- Certified by Canadian Standards Association, File No. LR 7189



Introduction

The High Current Edge family of connectors provides high reliability and economy in packages compatible with industry standards. While many new card edge connectors for signal applications have moved toward higher density configurations (0.050" and 1 mm centerlines), Tyco Electronics has redesigned the 0.100" standard edge product family to carry more current, for low power distribution.

This product family includes the following:

- CROWN EDGE Products
- Standard Edge Connector — 2nd generation
- SEC-II Power Products

The connectors serve low durability cycle applications which do not have the available room for a traditional 2-piece power distribution connector. In other applications, a low-profile connector is needed to allow for better airflow / less airflow restriction. This grouping of power card edge connectors is focused on providing high current density with the favored multi-point contact design which reduces contact interface resistance.

The connectors were used originally in the ISA Standard for computer expansion cards. Today these connectors are being used in applications such

as; DC-to-DC converters, low-wattage power supplies, industrial grade card extenders and general low cost I/O applications requiring durable/rugged card edge contacts. The improvements made still allows use in the original applications and they provide a lower resistance connection due to the high conductivity contacts plated with a minimum 30 micro inches gold.

The options include vertical or right-angle PCB mounting as well as straddle-mount configurations for co-planar PCB applications.

Introduction to High Current Card Edge Connectors (Continued)

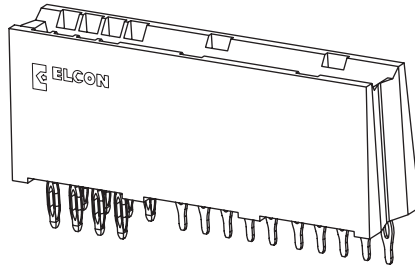

CROWN EDGE Connector

- Design based on CROWN BAND technology
- 35A per power contact
- True hot-plug power modules
- Flexible modular design
- Mates with .062 [1.6] thick card edge or bus bar tab

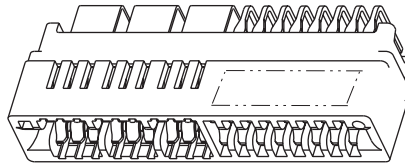

SEC-II Power Connector

- High current density than high current SEC II
- Uses new MULTI-BEAM style power contact
- Vertical, straddle or right-angle PCB mounting
- 22A (straddle) or 28A (vertical) power contact +3A signal contact

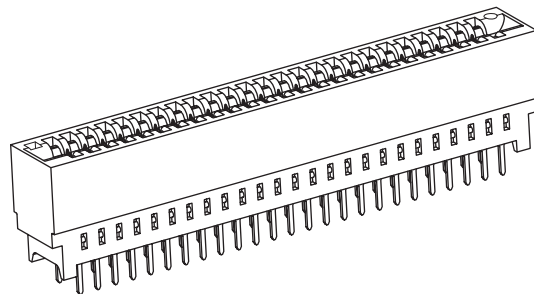

SEC-II Connectors

- Provides high reliability in packages compatible with industry standards for double-sided printed circuit boards
- Uses signal style contact
- High IACS copper alloy contacts available to improve current carrying capability
- Accepts double-sided boards .054 [1.27]-.070 [1.78] thick
- Maximum number of dual positions
 - .100 [2.54] Centerlines — 70 positions
 - .125 [3.18] Centerlines — 50 positions
 - .150 [3.81] Centerlines — 31 positions

CROWN EDGE Card Edge-style High Current Connectors

Product Facts

- Low cost power solution
- Power, signal and mixed modules
- 35A per power contact
- Mates with .062 (1.6 mm) thick card edge or bus bar tab
- Press-fit or solder tail terminations
- True hot-plug power modules
- Meets regulatory safety requirements
- All CROWN EDGE products in this section are RoHS compliant.

Typical Applications

- Board-to-board power connections
- DC-DC converters
- Uninterruptible Power Supply (UPS)
- Power supplies

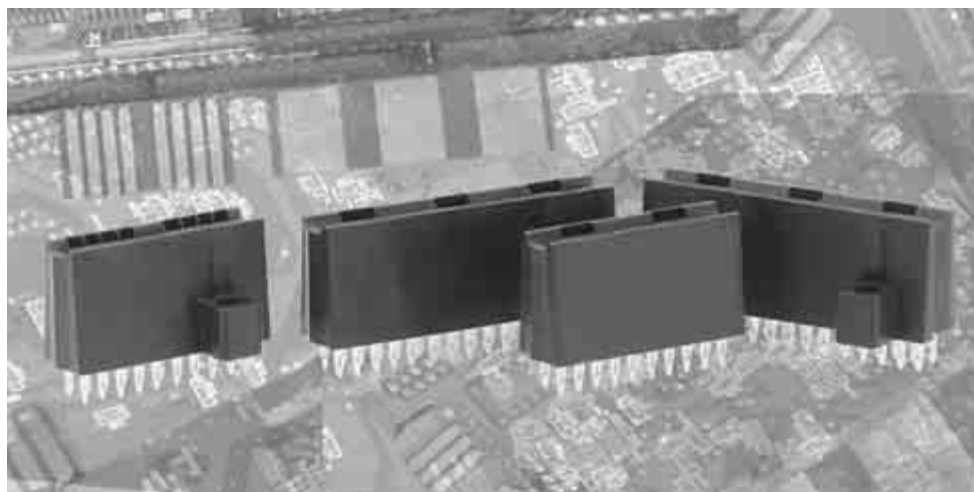

CROWN EDGE connectors are a board-to-board power interconnect solution that uses ELCON high performance CROWN BAND contact technology configured to mate directly with a printed circuit board edge or — for higher currents — with a solid bus bar. Power and signal can be combined and mounted end-to-end to meet the requirements of the applications.

Product Highlights

High-current Card Edge Interface

CROWN EDGE connectors use Tyco Electronics proven ELCON CROWN BAND contacts that provide multiple points of contact for high current, and low voltage drop and minimal heat generation. The desired current rating for most applications can be achieved by bussing multiple contacts or even modules. For even higher currents, CROWN EDGE connectors can be mounted onto a bus bar, and mate directly with a bus bar tab. Optimum interface to the mounting PC board is achieved through five termination tails.

Flexible Modular Design

To make easy work of power distribution design, CROWN EDGE connectors are available in modules of 2 and 3 contact segments with power or signal contacts or a combination of both in a single module. Modules can be placed end-to-end for assemblies up to 8" (203.20 mm) long. Custom molded configurations are possible on high-volume projects. Consult Tyco Electronics or your local Tyco Electronics sales representative for details.

Versatile Power Arrangements

Opposing contacts are isolated, so power connections at different voltage levels can be on one side of the board, with ground or power return on the other side.

True Hot-Plug Support

CROWN EDGE power modules that support current interruption under load as defined by safety regulatory agencies are also available for mating to a metal blade or bus bar tab. These true hot-plug modules allow current interruption under load by incorporating a contact design that restricts the effects of arcing to areas that do not compromise the integrity of the connection.

CROWN EDGE Card Edge-style High Current Connectors (Continued)

Product Specifications

Materials & Finishes			
Insulators		PPA, UL 94-V-0 flammability rated, color black	
Contacts	Non-hot-plug power contact	Copper alloy, selectively plated with gold (30 micro inches minimum) and tin on terminations, all over nickel	
	Hot-plug power contact	Contact holder	Phosphor bronze alloy, selectively plated with tin on terminations, over nickel
		CROWN BAND element	Beryllium copper alloy, selectively plated with gold (30 micro inches minimum), over nickel
	Signal contacts	Phosphor bronze alloy, selectively plated with gold (30 micro inches minimum) and tin on terminations, all over nickel	
Electrical			
Current ratings	Power contact	35A (see graph below)	
	Signal contact	3A max.	
Insulation resistance		5,000MΩ minimum at 500 VDC for 2 minutes, power MIL-STD 1344, Method 3003	
Dielectric strength		1,500VDC for 1 minute, per MIL-STD 1344, Method 3001	
Mechanical			
Mating PCB thickness		.062" 91.6 mm ±.006" (0.15 mm)	
Insertion Forces	2 segment power module	5.0 lbf typical using .062" (1.6 mm) thick mating board with 5 oz. of copper	
	3 segment power module	6.0 lbf typical using .062" (1.6 mm) thick mating board with 5 oz. of copper	
Extraction Forces	2 segment power module	3.0 lbf typical using .062" (1.6 mm) thick mating board with 5 oz. of copper	
	3 segment power module	5.0 lbf typical using .062" (1.6 mm) thick mating board with 5 oz. of copper	
Tooling		Press fixture is recommended for compliant press-fit assemblies Consult Tyco Electronics customer service for details	

Card Edge Products

Current Ratings

The chart below demonstrates the performance of the CROWN EDGE power contact by showing the temperature rise at different current levels applied to two power contacts connected in series.

Current rating for any given application will depend, among other things, on the module combination, PCB copper trace volume, and internal equipment temperature/air flow. Mounting and mating to a bus bar will increase current ratings.

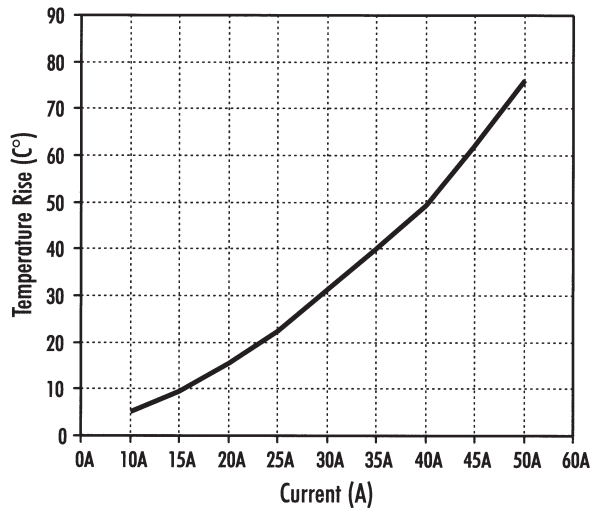

Safety Regulatory Compliance

CROWN EDGE connectors have been evaluated by Underwriters Laboratories and have been found to comply with the requirements of U.S. standard UL1997 and Canadian standard C22.2 No. 182.3-M1987.



Compliance with Current Interruption Requirements

Hot-plug CROWN EDGE modules are available for applications that require current interruption as defined by safety regulatory agencies. These power-only modules have been evaluated and recognized by Underwriters Laboratories for current interruption up to 50 cycles as per the UL1977 standard. See hot-plug requirements on page 180.

CROWN EDGE Card Edge-style High Current Connectors (Continued)

4-Position Power Module

Part Numbers

- 6651170-1 Long solder tail, non-hot-plug*
- 6651170-2 Press-fit tail, non-hot-plug*
- 6651170-3 Short solder tail, non-hot-plug*
- 6651331-1 Press-fit tail, hot-plug
- 6650380-1 Short solder tail, hot-plug
- 6650380-2 Long solder tail, hot-plug

* Also available for .093" (2.4 mm) thick mating board.
Contact Tyco Electronics Customer Service for details.

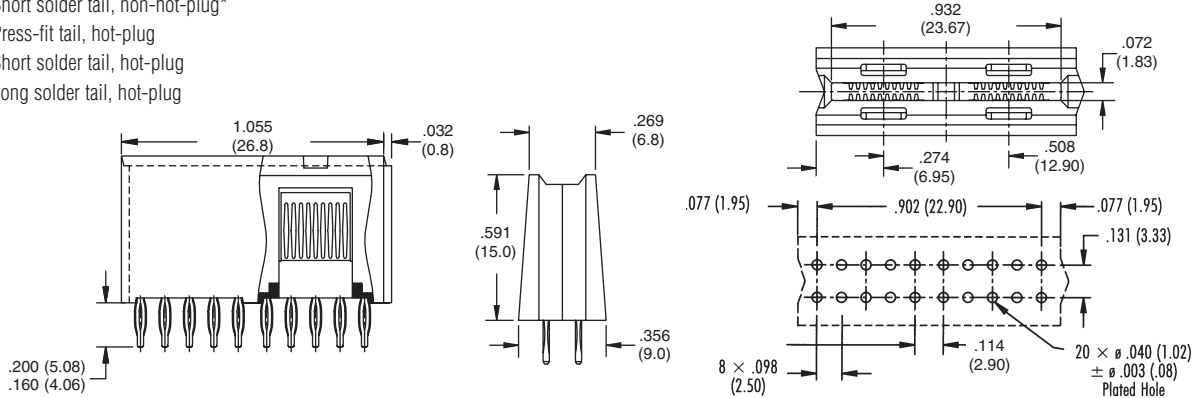

6-Position Power Module

Part Numbers

- 6650383-1 Press-fit tail, non-hot-plug
- 6650383-2 Long solder tail, non-hot-plug
- 6650383-3 Short solder tail, non-hot-plug
- 6650384-1 Short solder tail, hot-plug
- 6650384-2 Press-fit tail, hot-plug
- 6650384-3 Long solder tail, hot-plug

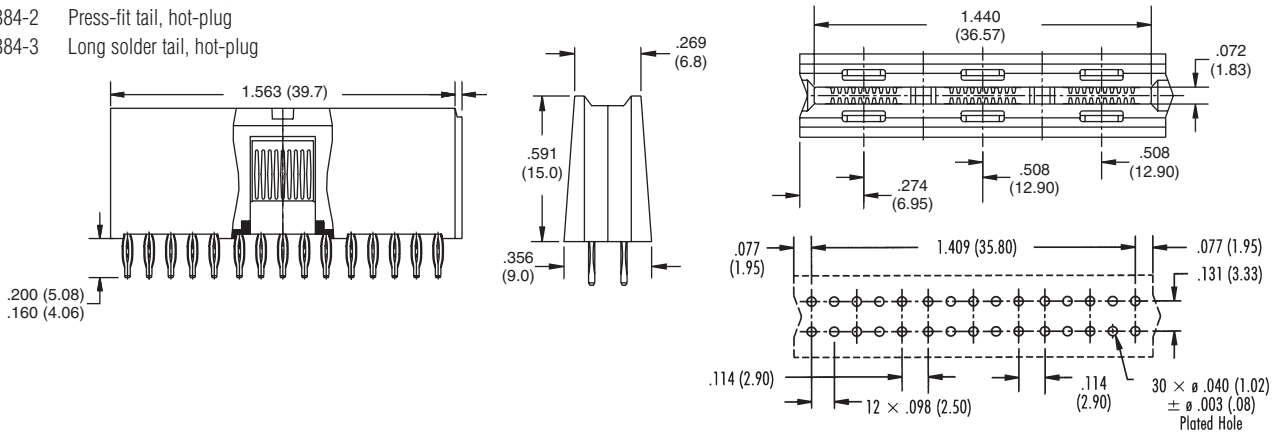

30-Position Signal Module

Part Number

- 1926088-1 Press-fit tail, non-hot-plug

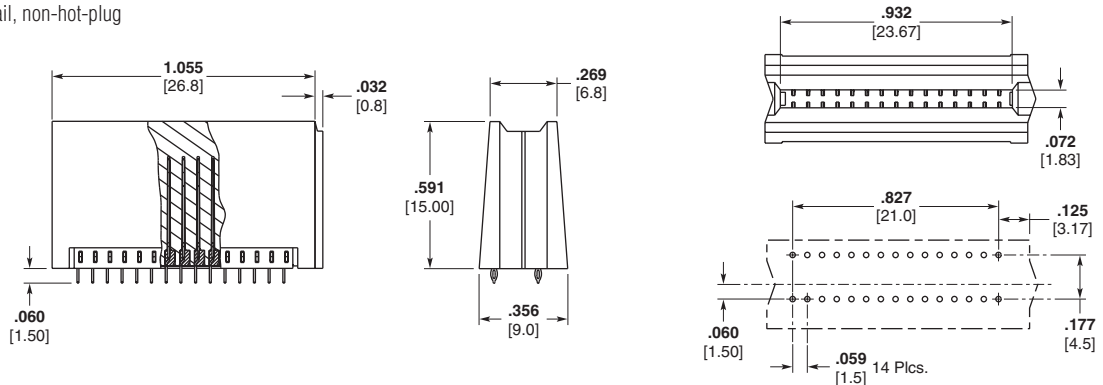

Note: All part numbers are RoHS compliant.

CROWN EDGE Card Edge-style High Current Connectors (Continued)

16-Position Signal Module

Part Numbers

6650534-1 Press-fit tail

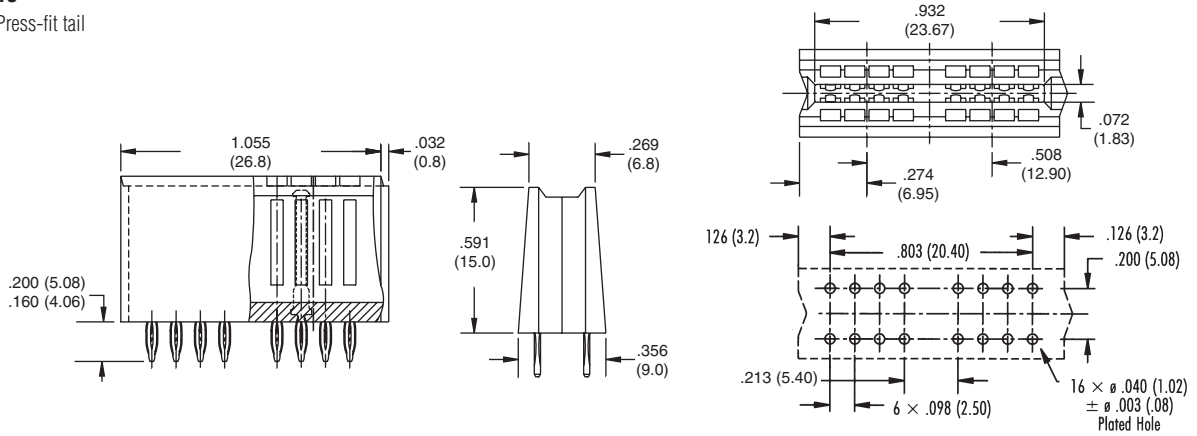

24-Position Signal Module

Part Numbers

- 6650494-1 Press-fit tail
- 6651193-1 Long solder tail
- 6651214-1 Short solder tail

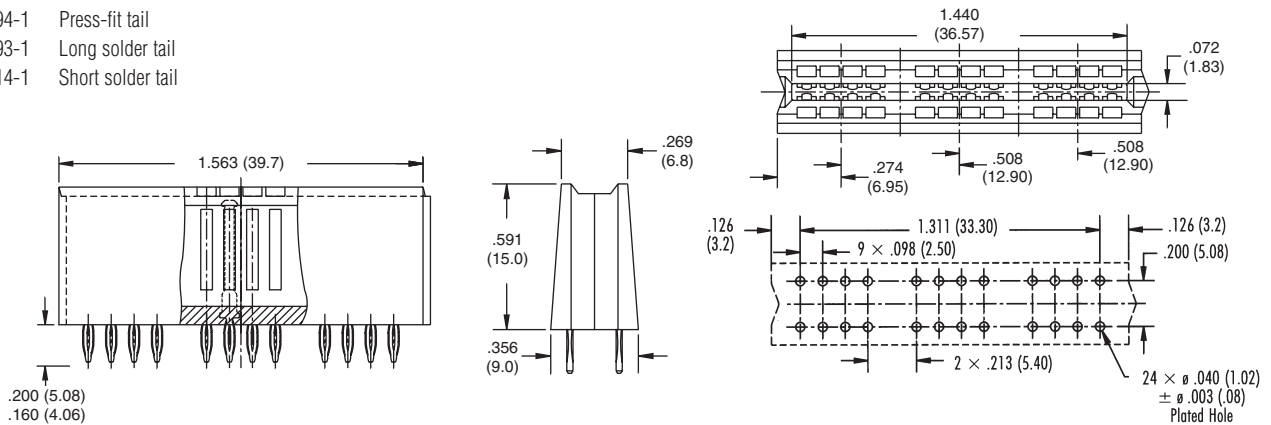

Note: All part numbers are RoHS compliant.

CROWN EDGE Card Edge-style High Current Connectors (Continued)

2 Power + 8 Signal Modules

Part Numbers

- 6643460-1 Short solder tail
- 6643460-2 Long solder tail
- 6643460-3 Press-fit tail

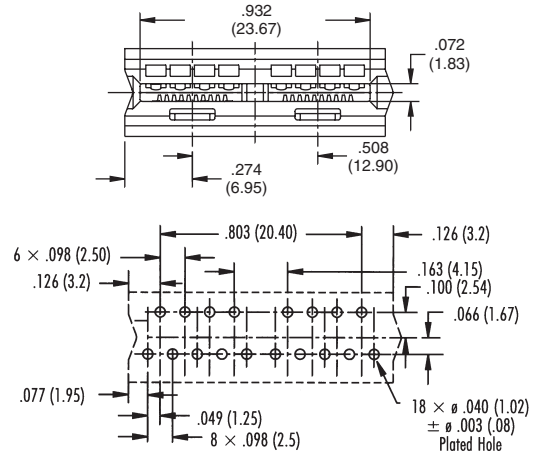
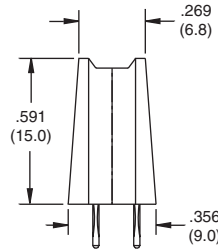
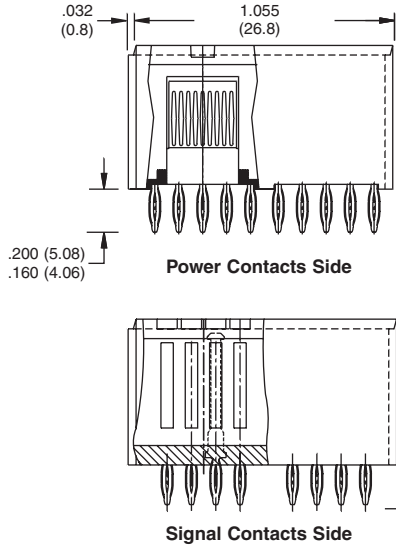

4 Power + 8 Signal Modules

Part Numbers

- 6651290-1 Press-fit tail
- 6651290-2 Long solder tail
- 6651290-3 Short solder tail

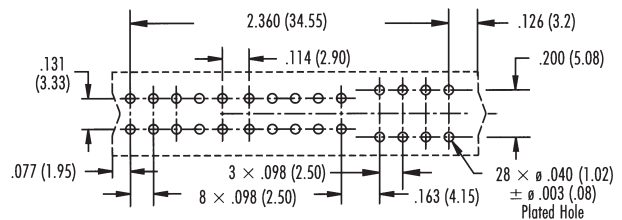
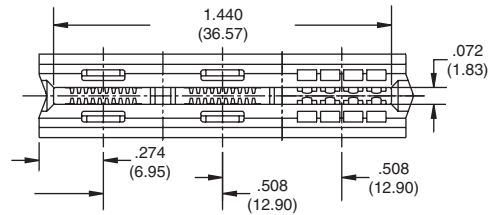
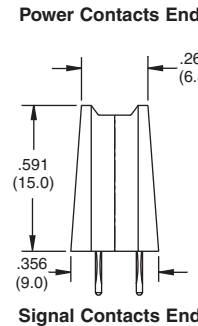
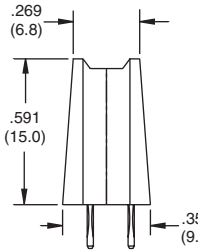
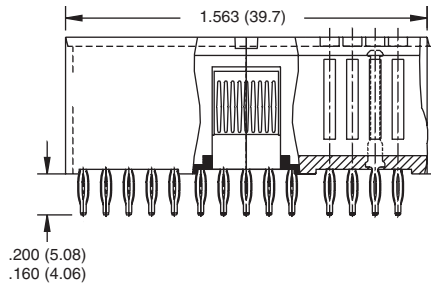

Note: All part numbers are RoHS compliant.

CROWN EDGE Card Edge-style High Current Connectors (Continued)

Design Notes

Mating PCB Requirements

Mating PCB edge fingers should be gold plated, have .050" (1.3 mm) side margins, and be of suitable copper weight for power applications. Mating board thickness is .062 [1.60].

Sequenced Mating

Sequenced mating can be achieved by designing one or more setback traces on the mating card edge, or by notching the edge of the card.

End-to-end Mounting

CROWN EDGE modules can be placed end-to-end for connector assemblies up to 8" (203.20 mm) long.

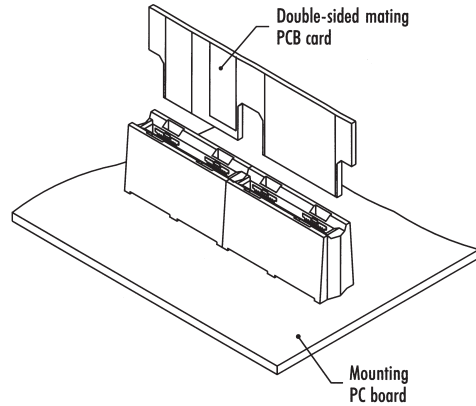

Card Edge Products

Mating PC Card Edge Samples

The drawings below show two PC card edge samples with signal and power lines designed to mate with 2 and 3-segment CROWN EDGE modules.

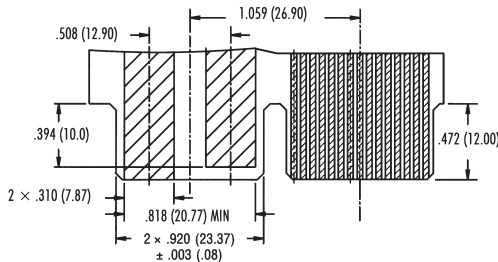

2 x 2 Segment Modules Provide Two Sequenced Power Traces and 30 Signal Traces

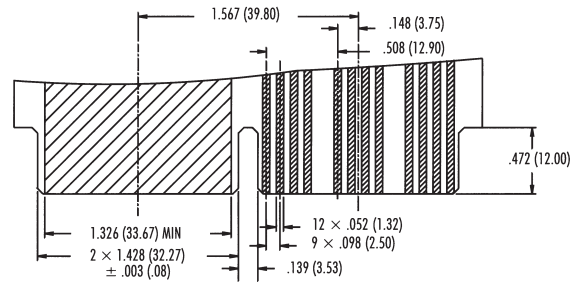

2 x 3 Segment Modules Provide Ground Plane and 12 Signal Lines

Hot-Plug Requirements

Hot-plug application of this product requires the use of the CROWN EDGE true hot-plug modules (see part numbers on pages 177-179) mated with a customer-supplied metal blade or bus bar. Dimensions of a sample mating blade for use with CROWN EDGE hot-plug modules is shown below.

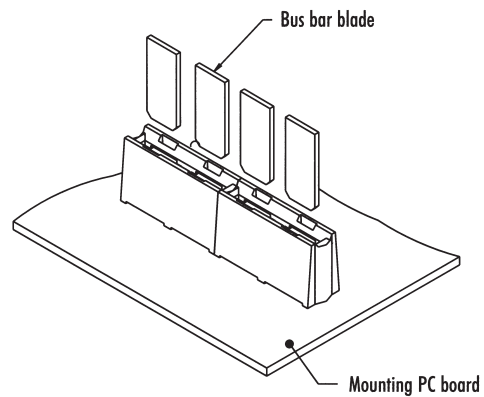
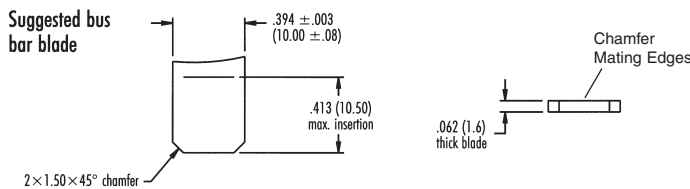

CROWN EDGE Card Edge-style High Current Connectors (Continued)

Connector Mounting

Solder Tails

Solder termination is available in two lengths. See table below for board thicknesses and recommended tail lengths.

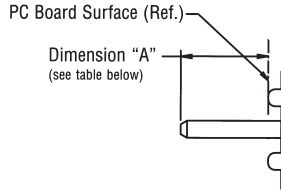

Solder Tail Detail

Press-fit Tails

CROWN EDGE connectors use truly compliant eye of the needle press-fit tails designed for boards 0.093" thick and above.

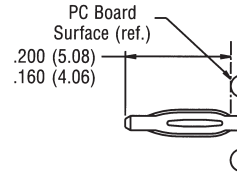

Press-fit Tail Detail

Tail Length vs. Board Thickness

Board Thickness	Dimension "A"
.062" (1.6 mm)	.100" - .140" (2.55 - 3.57 mm) [.115" (2.92 mm) nominal]
.092"/.125" (2.3/3.0 mm)	.160" - .200" (4.06 - 5.08 mm) [1.77" (4.5 mm) nominal]

Tooling for Compliant Press-fit Assemblies

Pressing fixtures are recommended for compliant press-fit assemblies. Contact Tyco Electronics for a detailed tool drawing.

Suggested Printed Circuit Hole for Power and 2.5 mm Signal

Finished Hole: $\varnothing .040 \pm .003$ [$\varnothing 1.02 \pm .08$]
 Drilled Hole: $\varnothing .0453 \pm .005$ [$\varnothing 1.151 \pm .013$]
 Copper Plate: .0010 [.025] min. (per surface)
 Tin Plate: .0003 [.008] min. (per surface)

Suggested Printed Circuit Hole for 1.5 mm Signal

Finished Hole: $\varnothing .022 \pm .002$ [$\varnothing 0.56 \pm 0.05$]
 Drilled Hole: $\varnothing .026 \pm .002$ [$\varnothing 0.65 \pm 0.02$]
 Copper Plate: .0010 [.025] min. (per surface)
 Tin Plate: .0003 [.008] min. (per surface)

Spacing Between Modules in End-to-end Mounting

This spacing between plated thru-holes for end-to-end mounting varies depending on the chosen module combination. Spacing for the three possible combinations is shown below.

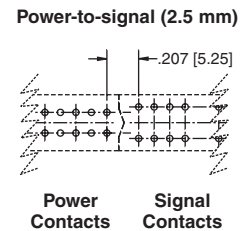
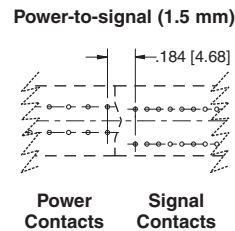
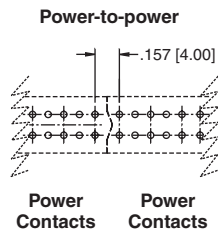

Custom Solutions

Non-standard Modules

In case the standard CROWN EDGE modules do not meet your design requirements, Tyco Electronics has the capability to mold any combination of power and signal contact layouts in 2 and 3 segment modules.



Application-specific Custom Designs

Tyco Electronics has a long history of designing and building application specific custom connectors, and CROWN EDGE connectors are no exception. A one-piece CROWN EDGE insulator, instead of a combination of several modules, provides a more robust interconnection design, as well as cost savings in high volume projects. Consult Tyco Electronics Customer Service for details.



SEC-II Power Products

Product Facts

- Combines industry standard 0.100" pitch card edge format in a high power density design
- Industry-proven multi-beam power contact design
- High conductivity contact materials
- High temperature housing materials
- UL 94V-0
- Selective gold plating for high performance with low cost
- .000030 [0.00076] gold in contact area. Tin/lead on posts with entire contact nickel underplated
- Power Contact Current Ratings:
 - 38 amps — Single Contact
 - 22 amps — on each of 4 adjacent pairs (8 power contacts)
- Signal Contact Ratings:
 - 6 amps — Single Contact
 - 4 amps — on each of 6 adjacent contacts



The trends in electronic power supplies require high current density and lower cost. In addition, smaller sized connectors are needed to provide less airflow restriction for cooling the power supplies. The SEC-II power connectors offer an ideal combination of low-current and high-current connections in a single, durable design.

SEC-II power connectors are built on an expandable tooling platform which allows for a variety of combinations of power and signal contacts, all

combined in a single molded housing. The vertical press-fit versions are ideal for high density stacking of cards into a backplane or for low air restriction of blade-style power supply designs. The straddle mount style offers a true co-planar interconnection with a total height of less than 4 mm from the top surface of the PCB.

SEC-II power connectors are currently in use in high-end computer and data storage equipment. Extensive testing in exposure to high vibration and

shock has proven these connectors equally suited for industrial applications as well, where low contact resistance and high current density is required.

Product Specification

108-2202

Qualification Test Report

501-608



Vertical

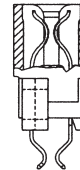

Co-Planar

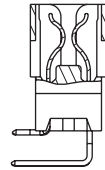

Right-Angle

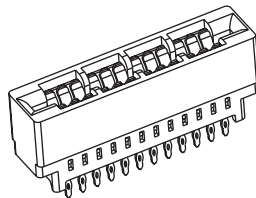

8P

Power Only

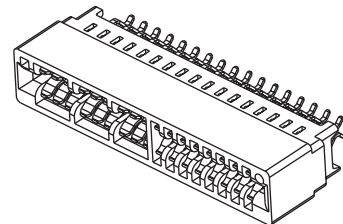

6P + 16S

Power and Signal

Note: See page 183 for part numbers and details.

SEC-II Power Products (Continued)

Co-Planar Application
Straddle-Mount to .062 [1.6]
PCB

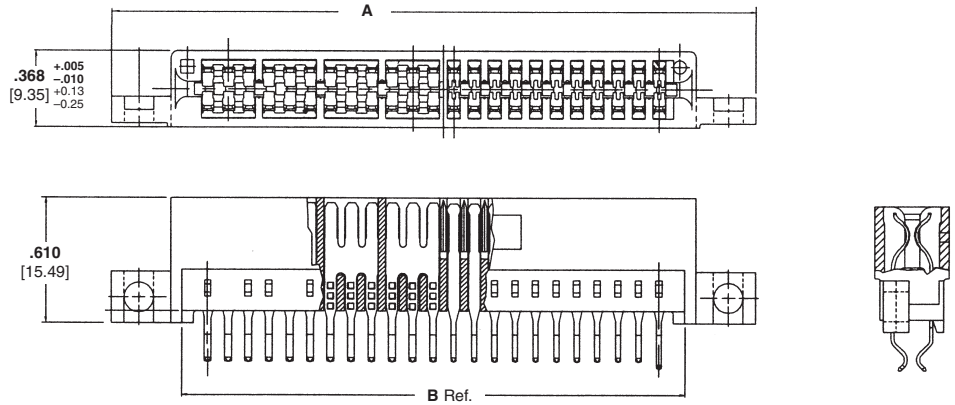

No. of Power Contacts	No. of Signal Contacts	Dimensions		With or Without Mounting Ears	Part Number
		"A" Length	"B" Card Slot		
4	16	1.66 42.16	1.500 38.10	Without	2007088-2
6	16	1.960 49.78	1.800 45.72	Without	2007088-1
6	20	2.745 69.72	2.000 50.80	With	1761500-1
8	16	2.260 57.40	2.100 53.40	Without	2007088-3
8	22	3.145 79.88	2.400 60.96	With	1761879-1

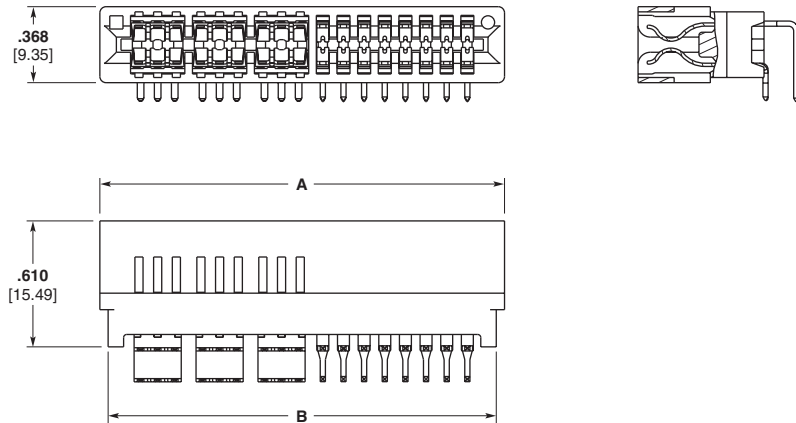

No. of Power Contacts	No. of Signal Contacts	Dimensions		Part Number
		"A" Length	"B" Card Slot	
6	16	1.960 49.78	1.880 47.75	2057372-1

Note: All part numbers are RoHS compliant.

SEC-II Power Products (Continued)

Vertical PCB-Mount

Seating tool required

*See customer drawing for details

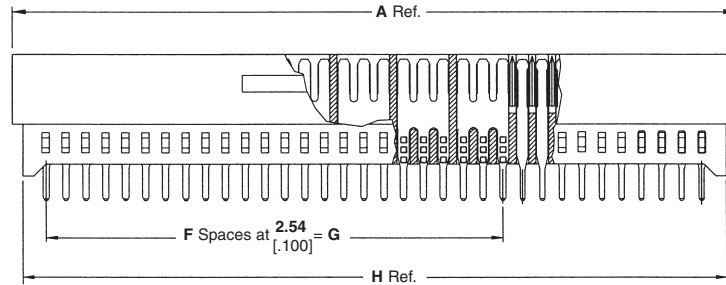
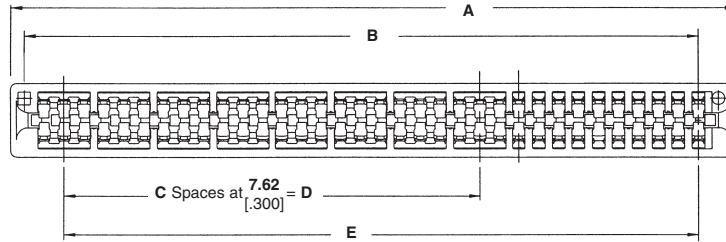



Card Edge Products

Dimensions								No. of Power Contacts	No. of Signal Contacts	Omitted PIN	Molded Key Location	Part Number
A	B	C	D	E	F	G	H					
Power and Signal, Solder Tail												
92.93 [3.660]	88.90 [3.500]	7	53.34 [2.100]	81.28 [3.200]	23	58.42 [2.300]	90.18 [3.550]	16	20	None	None	1761426-1
70.1 [2.760]	66.07 [2.600]	4	30.48 [1.200]	58.42 [2.300]	14	35.56 [1.400]	67.31 [2.650]	10	20	None	None	1761426-2
54.86 [2.160]	50.80 [2.000]	2	15.24 [0.600]	43.18 [1.700]	8	20.32 [0.800]	52.07 [2.050]	6	20	None	None	1761426-3
Power and Signal, Press-Fit												
54.61 [2.150]	50.80 [2.000]	3	22.86 [0.900]	40.64 [1.600]	17	43.16 [1.700]	49.53 [1.950]	8	12	None	None	1761786-1
Power only, Press-Fit												
24.13 [0.950]	20.32 [0.800]	1	3.81 [0.150]	12.70 [0.500]	5	N/A	18.79 [0.740]	4	0	None	None	1888946-1
31.75 [1.250]	27.94 [1.100]	2	7.62 [0.300]	20.32 [0.800]	8	N/A	26.42 [1.040]	6	0	None	None	1888946-2
39.37 [1.550]	35.56 [1.400]	3	11.43 [0.450]	27.94 [1.100]	11	N/A	34.03 [1.340]	8	0	None	None	1888946-3

Note: All part numbers are RoHS compliant.

Standard Edge II Card Edge Connectors

Product Facts

- Maximum number of dual positions
.100 [2.54] Centerlines-70,
.125 [3.18] Centerlines-50,
.150 [3.81] Centerlines-31
- Selective gold plating of contacts for high performance at low cost
- .025 [0.64] square solid posts meet standard wrap-type specifications
- For flow solder applications
- Glass-filled polyester housing is 94V-0 rated
- Accepts double sided PC boards, .054-.070 [1.27-1.78] thick
- Recognized under the Component Program of Underwriters Laboratories Inc., File No. E28476 
- Certified by Canadian Standards Association, File No. LR 7189 

Performance Specifications

- Contact Rating*** — 3 Amps continuous (UL and CSA)
- Contact Resistance** — 10 milliohms max.
- Operating Temperature** — -55°C to +85°C
- Voltage Rating (Sea Level)** —
.100 [2.54] centerline — 1000 VAC (test)
.125 [3.18] centerline — 1500 VAC (test)
.150 [3.81] centerline — 1500 VAC (test)
- Insulation Resistance** — 5000 megohms min., after exposure to humidity
- Vibration Tolerance** — 10 to 500 Hz
- Contact Engagement Force** — 12 oz [3.3 N] average per pair with .062 [1.57] PC board
- Contact Separation Force** — 2 oz [0.6 N] average per pair with .062 [1.57] PC board
- Humidity Tolerance** — 90%-95% for 96 hours

*Consult Tyco Electronics engineering when paralleling contacts for power applications.



Tyco Electronics Standard Edge II Connectors provide high reliability and economy in packages compatible with industry standards for double sided printed circuit boards.

Tyco Electronics offers Standard Edge II Connectors with or without mounting ears, for rack mounting and soldering. Contacts are arranged on .100 [2.54] centers, .125 [3.18] centers, .150 [3.81] centers, .200 [5.08] row-to-row; and .250 [6.35] row-to-row.

Right-angle connectors are also available with contacts arranged on .100 [2.54] centers, .150 [3.81] row-to-row or .200 [5.08] row-to-row.

Card extenders with contacts on .100 [2.54] and .125 [3.18] centers also are available.

Precision formed phosphor bronze contacts are selectively gold plated. Phosphor bronze has excellent strength characteristics which help the connector absorb load deflection movement of a PC board while maintaining sufficient contact force for good electrical connection. Bifurcated cantilever beam contacts provide redundant contact.

Standard Edge II Card Edge Connectors (Continued)

.100 [2.54] Centerline, Vertical Solder Posts, Without Mounting Ears

Material and Finish

Housing — Black glass-filled polyester, 94V-0 rated

Contacts — Phosphor bronze, duplex plated as follows:

Plating — .000030 [0.00076] gold in contact area, tin on posts, with entire contact nickel underplated

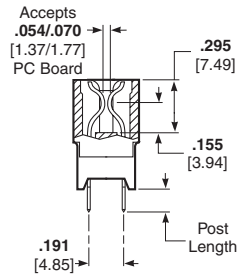
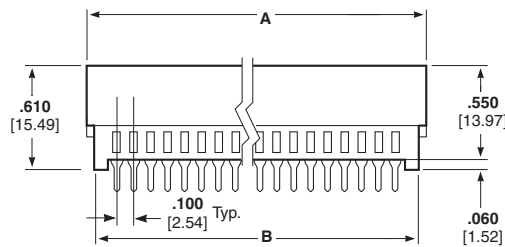
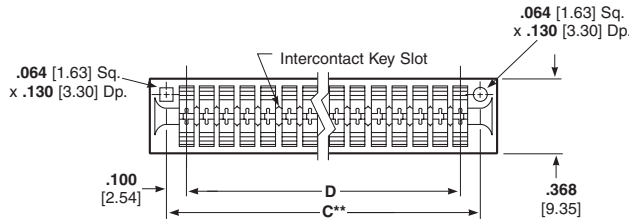

Technical Documents

Product Specification

108-9039

Qualification Test Report

501-227

Card Edge Products

Intercontact Keying Plug

Material

Natural color polyester

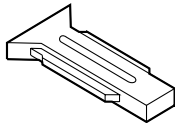

Part Number 650025-2
(.100 [2.54] Centerline)

No. of Dual Positions	Dimensions				Post Length*	Part Numbers*** Solder Tail
	A	B	C**	D		
6	.860 21.84	.750 19.05	.700 17.78	.500 12.70	.125 3.18	7-5530843-5
10	1.260 32.00	1.150 29.21	1.100 27.94	.900 22.86	.125 3.18	5-5530843-0
12	1.460 37.08	1.350 34.29	1.300 33.02	1.100 27.94	.125 3.18	8-5530843-3
15	1.760 44.70	1.650 41.91	1.600 40.64	1.400 35.56	.125 3.18	5530843-2
17	1.960 49.78	1.850 46.99	1.800 45.72	1.600 40.64	.125 3.18	5-5530843-3
18	2.060 52.32	1.950 49.53	1.900 48.26	1.700 43.18	.125 3.18	5530843-3
20	2.260 57.40	2.150 54.61	2.100 53.34	1.900 48.26	.125 3.18	5-5530843-4
22	2.640 62.48	2.350 59.69	2.300 58.42	2.100 53.34	.125 3.18	5530843-4
25	2.760 70.10	2.650 67.31	2.600 66.04	2.400 60.96	.125 3.18	5530843-5
28	3.060 77.72	2.950 74.93	2.900 73.66	2.700 68.58	.125 3.18	5530843-6
30	3.260 82.80	3.150 80.01	3.100 78.74	2.900 73.66	.125 and .187 3.18 and 4.75	5530843-7
31	3.360 85.34	3.250 82.55	3.200 81.28	3.000 76.20	.125 3.18	6-5530843-5
35	3.760 95.50	3.650 92.71	3.600 91.44	3.400 86.36	.125 3.18	2-5530843-3
36	3.860 98.04	3.750 95.25	3.700 93.98	3.500 88.90	.125 3.18	5530843-8
40	4.260 108.20	4.150 105.41	4.100 104.14	3.900 99.06	.187 3.18	2-5530843-0
50	5.260 133.60	5.150 130.81	5.100 129.54	4.900 124.46	.187 3.18	2-5530843-2

*Contact Tyco Electronics for alternate post length.

**C dimension is card slot length.

***Press-fit parts can be made available, consult Tyco Electronics.

Notes: 1. Other connector sizes can be made available, consult Tyco Electronics.

2. High temperature IR reflow compatible connectors can be made available, consult Tyco Electronics.

Note: All part numbers are RoHS compliant.

Standard Edge II Card Edge Connectors (Continued)

.100 [2.54] Right-Angle Solder Posts, with Low and No Mounting Ears

Material and Finish

Housing — Black glass-filled polyester, 94V-0 rated

Contacts — Phosphor bronze, duplex plated as follows:

Plating A — .000030 [0.00076] gold in contact area, tin on posts, with entire contact nickel underplated

Plating B — .000015 [0.00038] gold in contact area, tin on posts, with entire contact nickel underplated

Related Product Data

Performance Specifications — page 185

Technical Documents

Product Specification
108-9039

Interconnect Keying Plug

Material

Natural color polyester

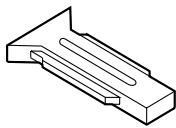

Part Number 650025-2
(.100 [2.54] Centerline)

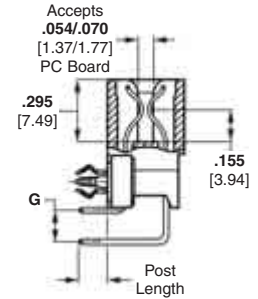
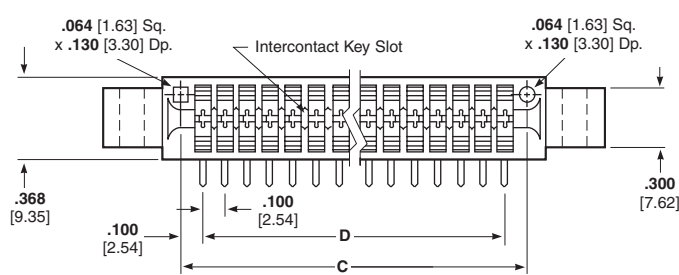

With Board Locks

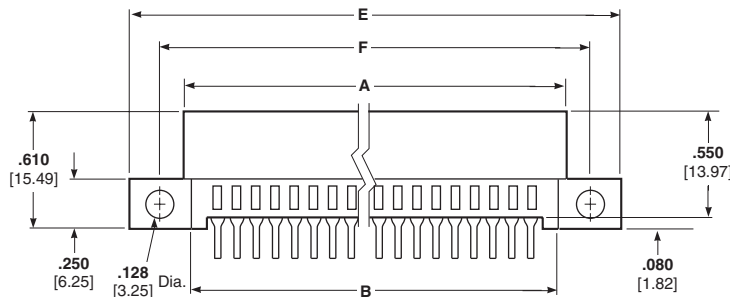

Low Mounting Ears

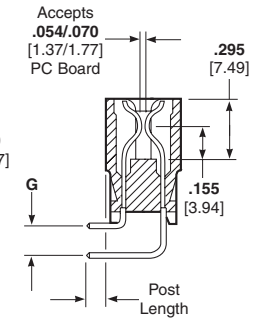

Low Mounting Ears

No. of Dual Positions	Dimensions							Post Length ²	Part Numbers (Plating A)
	A	B	C*	D	E	F	G ¹		
12	1.460 37.08	1.350 34.29	1.300 33.02	1.100 27.94	2.045 51.94	1.775 45.08	.100x .150	.090	5145089-1 ³
18	2.060 52.32	1.950 49.53	1.900 48.26	1.700 43.18	2.645 67.18	2.375 60.32	.100x .150	.090	5645384-1
20	2.260 57.40	2.150 54.61	2.100 53.34	1.900 48.26	2.845 72.30	2.575 65.40	.100x .150	.090	5645384-3

*C dimension is card slot length.

¹ Metric equivalent for .100 x .150 and .100 x .200 are [2.54 x 3.81] and [2.54 x 5.08].

² Metric equivalent for post length is .090 = [2.27].

³ Connector with Board Locks.

Note: Other connector sizes can be made available, consult Tyco Electronics.

No Mounting Ears

No. of Dual Positions	Dimensions					Post Length ²	Part Numbers	
	A	B	C*	D	G ¹		Plating A	Plating B
10	1.260 32.00	1.150 29.21	1.100 27.94	0.900 22.96	.100x .150	.090	5650118-2	—
15	1.760 44.70	1.650 41.91	1.600 40.64	1.400 35.56	.100x .150	.090	5650118-1	—
19	2.160 54.86	2.750 69.85	2.700 68.58	1.800 45.72	.100x .150	.090	—	5532600-6
25	2.760 70.10	2.350 67.61	2.600 66.04	2.400 60.96	.100x .150	.090	—	5532600-2
31	3.360 85.34	3.250 82.55	3.200 81.28	3.000 76.20	.100x .150	.090	—	5532600-4
32	3.460 87.88	3.350 85.09	3.300 83.82	3.100 78.74	.100x .150	.090	—	5532600-5

*C dimension is card slot length.

¹ Metric equivalent for .100 x .150 and .100 x .200 are [2.54 x 3.81] and [2.54 x 5.08].

² Metric equivalent for post length is .090 = [2.27].

Notes: 1. Other connector sizes can be made available, consult Tyco Electronics.

2. High temperature IR reflow compatible connectors can be made available, consult Tyco Electronics.

Note: All part numbers are RoHS compliant.

Данный компонент на территории Российской Федерации

Вы можете приобрести в компании MosChip.

Для оперативного оформления запроса Вам необходимо перейти по данной ссылке:

<http://moschip.ru/get-element>

Вы можете разместить у нас заказ для любого Вашего проекта, будь то серийное производство или разработка единичного прибора.

В нашем ассортименте представлены ведущие мировые производители активных и пассивных электронных компонентов.

Нашей специализацией является поставка электронной компонентной базы двойного назначения, продукции таких производителей как XILINX, Intel (ex.ALTERA), Vicor, Microchip, Texas Instruments, Analog Devices, Mini-Circuits, Amphenol, Glenair.

Сотрудничество с глобальными дистрибьюторами электронных компонентов, предоставляет возможность заказывать и получать с международных складов практически любой перечень компонентов в оптимальные для Вас сроки.

На всех этапах разработки и производства наши партнеры могут получить квалифицированную поддержку опытных инженеров.

Система менеджмента качества компании отвечает требованиям в соответствии с ГОСТ Р ИСО 9001, ГОСТ РВ 0015-002 и ЭС РД 009

Офис по работе с юридическими лицами:

105318, г.Москва, ул.Щербаковская д.3, офис 1107, 1118, ДЦ «Щербаковский»

Телефон: +7 495 668-12-70 (многоканальный)

Факс: +7 495 668-12-70 (доб.304)

E-mail: info@moschip.ru

Skype отдела продаж:

moschip.ru

moschip.ru_4

moschip.ru_6

moschip.ru_9