

A Dimensions: [mm]

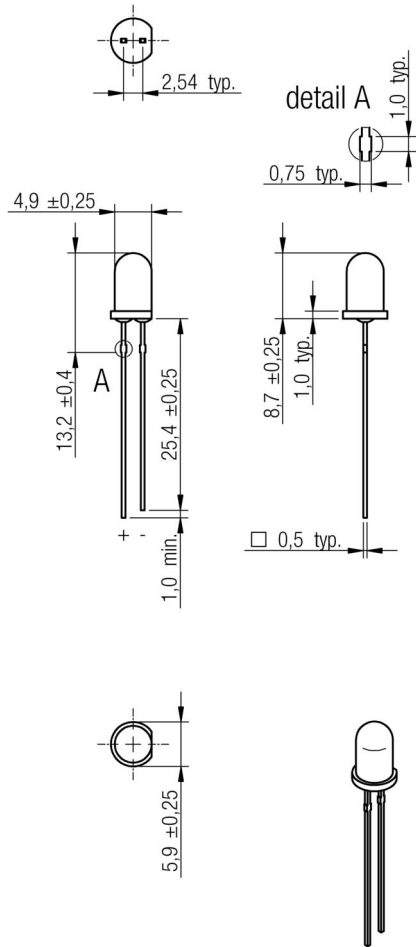

Scale - 1:1

B Recommended hole pattern: [mm]

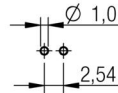

Scale - 1:1

C Schematic:

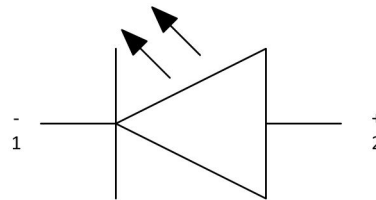

D Absolute Maximum Ratings (Ambient Temperature 25°C):

Properties	Test conditions		Value	Unit
Power dissipation		P_{Diss}	75	mW
Peak Forward Current	duty/10@1kHz	$I_F Peak$	100	mA
Continuous Forward Current		I_F	30	mA
Reverse Voltage		V_{Rev}	5	V
ESD Threshold/ Human Body Modell		$V_{ESD HBM}$	2000	V

E General information:

- Operating temperature: -40°C to +85°C
- Storage temperature (on tape & reel): -40°C to +85°C; 60% RH max.
- Moisture Sensitivity Level (MSL): 1

Optical Properties:

Properties	Value
Chip Technology	AlGaInP
Emitting Color	Red
Lens Type	Color diffused

REV	DATE	BY	CHECKED
2.6	2015-03-23	SSt	HOe
2.5	2014-11-03	SSt	ZAn
2.4	2014-03-17	SSt	SSt
2.3	2013-12-09	SSt	PLD
2.2	2013-10-08	SSt	PLD
2.1	2013-09-10	SSt	SSt
2.0	2013-07-30	SSt	PLD

Projection

Würth Elektronik eiSos GmbH & Co. KG
EMC & Inductive Solutions
Max-Eyth-Str. 1
74638 Waldenburg
Germany
Tel. +49 (0) 79 42 945 - 0
www.we-online.com
eiSos@we-online.com

DESCRIPTION

WL-TMRC THT LED round mono-color color lens

Order.- No. **151051RS11000**

Size: 5 mm

COMPLIANT **RoHS&REACH** HALOGENFREE

SIZE
A4



D Electrical & Optical Properties:

Properties	Test conditions		Value			Unit
			min.	typ.	max.	
Peak Wavelength	20 mA	λ_{Peak}		650		nm
Dominant wavelength	20 mA	λ_{Dom}		645		nm
Luminous Intensity	20 mA	I_V	-	30		mcd
Forward Voltage	20 mA	V_F		2.1	2.5	V
Spectral Bandwidth	20 mA	$\Delta\lambda$		30		nm
Reverse Current	5 V	I_{Rev}			10	μA
Viewing Angle	20 mA	$2\theta_{50\%}$		60		°

				Projection		DESCRIPTION	WL-TMRC THT LED round mono-color color lens
2.6	2015-03-23	SSt	HOe				
2.5	2014-11-03	SSt	ZAn			Order.- No.	SIZE
2.4	2014-03-17	SSt	SSt			151051RS11000	A4
2.3	2013-12-09	SSt	PLD				Size: 5 mm
2.2	2013-10-08	SSt	PLD			COMPLIANT RoHS&REACH HALOGENFREE	
2.1	2013-09-10	SSt	SSt				
2.0	2013-07-30	SSt	PLD				
REV	DATE	BY	CHECKED				

Würth Elektronik eiSos GmbH & Co. KG
 EMC & Inductive Solutions
 Max-Eyth-Str. 1
 74638 Waldenburg
 Germany
 Tel. +49 (0) 79 42 945 - 0
 www.we-online.com
 eiSos@we-online.com

This electronic component has been designed and developed for usage in general electronic equipment only. This product is not authorized for use in equipment where a higher safety standard and reliability standard is especially required or where a failure of the product is reasonably expected to cause severe personal injury or death, unless the parties have executed an agreement specifically governing such use. Moreover Würth Elektronik eiSos GmbH & Co KG products are neither designed nor intended for use in areas such as military, aerospace, aviation, nuclear control, submarine, transportation (automotive control, train control, ship control), transportation signal, disaster prevention, medical, public information network etc.. Würth Elektronik eiSos GmbH & Co KG must be informed about the intent of such usage before the design-in stage. In addition, sufficient reliability evaluation checks for safety must be performed on every electronic component which is used in electrical circuits that require high safety and reliability functions or performance.



F1 Viewing Angle:

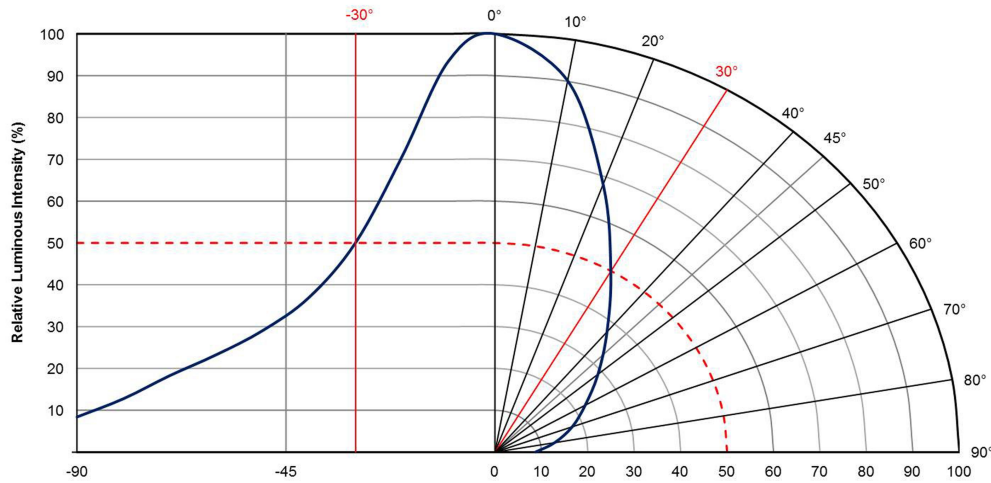

F2 Spectral:

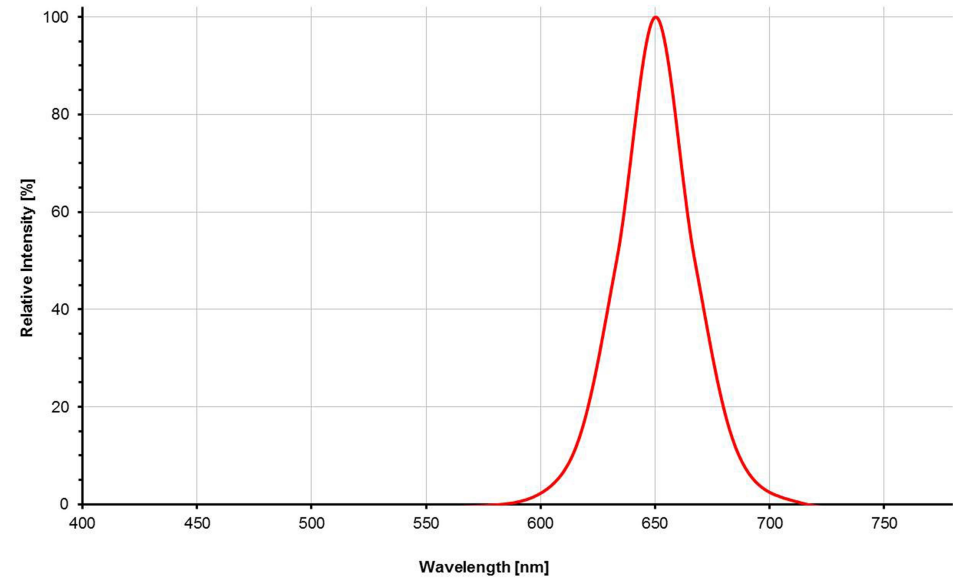

				Projection			DESCRIPTION	
2.6	2015-03-23	SSt	HOe	Würth Elektronik eiSos GmbH & Co. KG EMC & Inductive Solutions Max-Eyth-Str. 1 74638 Waldenburg Germany Tel. +49 (0) 79 42 945 - 0 www.we-online.com eiSos@we-online.com	WL-TMRC THT LED round mono-color color lens	COMPLIANT RoHS&REACH HALOGENFREE	Order.- No.	SIZE
2.5	2014-11-03	SSt	ZAn				151051RS11000	A4
2.4	2014-03-17	SSt	SSt				Size: 5 mm	
2.3	2013-12-09	SSt	PLD					
2.2	2013-10-08	SSt	PLD					
2.1	2013-09-10	SSt	SSt					
2.0	2013-07-30	SSt	PLD					
REV	DATE	BY	CHECKED					

This electronic component has been designed and developed for usage in general electronic equipment only. This product is not authorized for use in equipment where a higher safety standard and reliability standard is especially required or where a failure of the product is reasonably expected to cause severe personal injury or death, unless the parties have executed an agreement specifically governing such use. Moreover Würth Elektronik eiSos GmbH & Co KG products are neither designed nor intended for use in areas such as military, aerospace, aviation, nuclear control, submarine, transportation (automotive control, train control, ship control), transportation signal, disaster prevention, medical, public information network etc.. Würth Elektronik eiSos GmbH & Co KG must be informed about the intent of such usage before the design-in stage. In addition, sufficient reliability evaluation checks for safety must be performed on every electronic component which is used in electrical circuits that require high safety and reliability functions or performance.



F3 Forward Current vs. Forward Voltage:

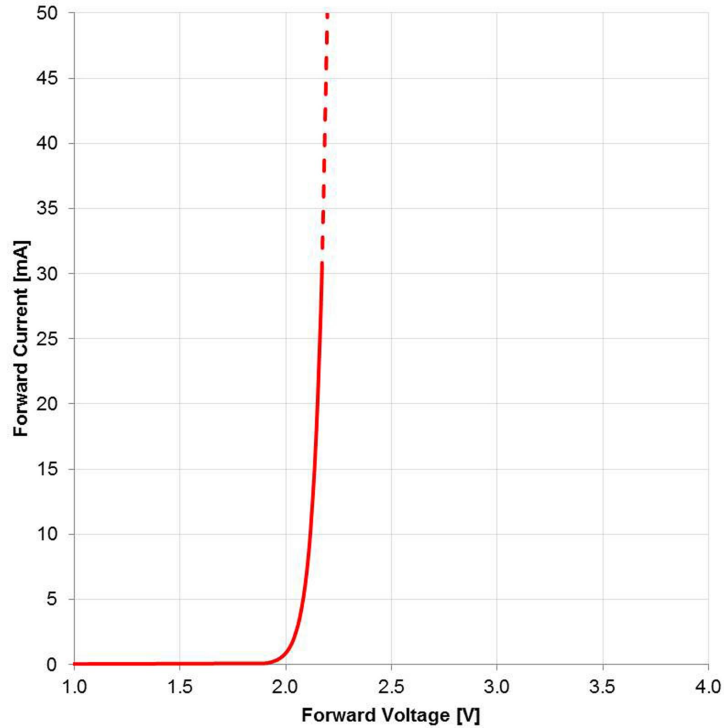

F4 Luminous Intensity vs. Forward Current:

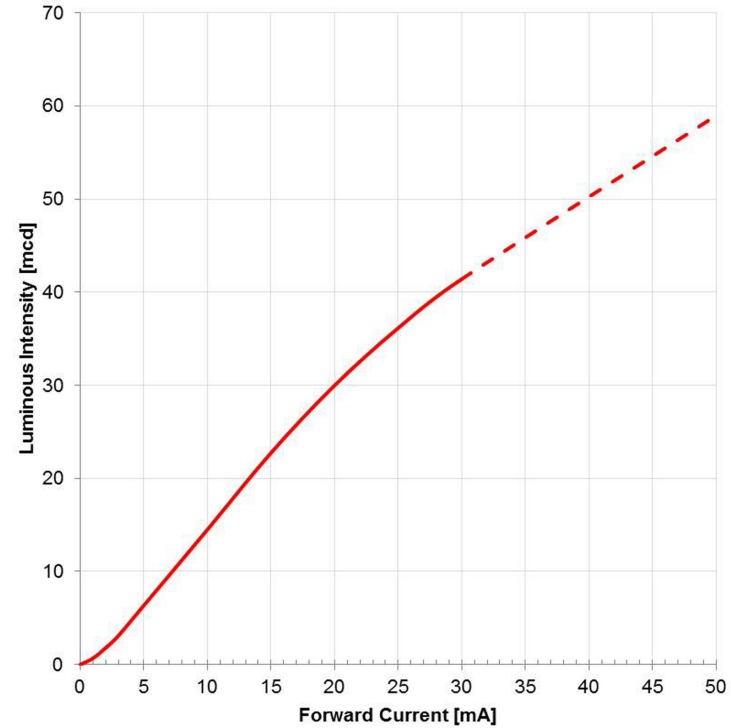

				Projection			DESCRIPTION	
2.6	2015-03-23	SSt	HOe	Würth Elektronik eiSos GmbH & Co. KG EMC & Inductive Solutions Max-Eyth-Str. 1 74638 Waldenburg Germany Tel. +49 (0) 79 42 945 - 0 www.we-online.com eiSos@we-online.com		WL-TMRC THT LED round mono-color color lens	Order.- No.	SIZE
2.5	2014-11-03	SSt	ZAn				151051RS11000	A4
2.4	2014-03-17	SSt	SSt				Size: 5 mm	
2.3	2013-12-09	SSt	PLD					
2.2	2013-10-08	SSt	PLD					
2.1	2013-09-10	SSt	SSt					
2.0	2013-07-30	SSt	PLD					
REV	DATE	BY	CHECKED					

This electronic component has been designed and developed for usage in general electronic equipment only. This product is not authorized for use in equipment where a higher safety standard and reliability standard is especially required or where a failure of the product is reasonably expected to cause severe personal injury or death, unless the parties have executed an agreement specifically governing such use. Moreover Würth Elektronik eiSos GmbH & Co KG products are neither designed nor intended for use in areas such as military, aerospace, aviation, nuclear control, submarine, transportation (automotive control, train control, ship control), transportation signal, disaster prevention, medical, public information network etc.. Würth Elektronik eiSos GmbH & Co KG must be informed about the intent of such usage before the design-in stage. In addition, sufficient reliability evaluation checks for safety must be performed on every electronic component which is used in electrical circuits that require high safety and reliability functions or performance.



F5 Derating Curve:



				Projection		DESCRIPTION WL-TMRC THT LED round mono-color color lens	
2.6	2015-03-23	SSt	HOe				
2.5	2014-11-03	SSt	ZAn	Würth Elektronik eiSos GmbH & Co. KG EMC & Inductive Solutions Max-Eyth-Str. 1 74638 Waldenburg Germany Tel. +49 (0) 79 42 945 - 0 www.we-online.com eiSos@we-online.com	Order.- No.	 COMPLIANT RoHS&REACH HALOGENFREE	SIZE
2.4	2014-03-17	SSt	SSt		151051RS11000		A4
2.3	2013-12-09	SSt	PLD		Size: 5 mm		
2.2	2013-10-08	SSt	PLD				
2.1	2013-09-10	SSt	SSt				
2.0	2013-07-30	SSt	PLD				
REV	DATE	BY	CHECKED				

This electronic component has been designed and developed for usage in general electronic equipment only. This product is not authorized for use in equipment where a higher safety standard and reliability standard is especially required or where a failure of the product is reasonably expected to cause severe personal injury or death, unless the parties have executed an agreement specifically governing such use. Moreover Würth Elektronik eiSos GmbH & Co KG products are neither designed nor intended for use in areas such as military, aerospace, aviation, nuclear control, submarine, transportation (automotive control, train control, ship control), transportation signal, disaster prevention, medical, public information network etc.. Würth Elektronik eiSos GmbH & Co KG must be informed about the intent of such usage before the design-in stage. In addition, sufficient reliability evaluation checks for safety must be performed on every electronic component which is used in electrical circuits that require high safety and reliability functions or performance.

G1 Packaging Specification - Bulk [mm]:



	Packaging Type	Packaging Unit
size	151031xx	Bulk 500
	151032xx	Bulk 500
	151033xxx	Bulk 500
	151034xx	Bulk 500
	151051xx	Bulk 250
	151052xx	Bulk 250
	151053xxx	Bulk 500
	151054xxx	Bulk 500



REV	DATE	BY	CHECKED
2.6	2015-03-23	SSt	HOe
2.5	2014-11-03	SSt	ZAn
2.4	2014-03-17	SSt	SSt
2.3	2013-12-09	SSt	PLD
2.2	2013-10-08	SSt	PLD
2.1	2013-09-10	SSt	SSt
2.0	2013-07-30	SSt	PLD

Projection 



Würth Elektronik eiSos GmbH & Co. KG
 EMC & Inductive Solutions
 Max-Eyth-Str. 1
 74638 Waldenburg
 Germany
 Tel. +49 (0) 79 42 945 - 0
 www.we-online.com
 eiSos@we-online.com

DESCRIPTION

WL-TMRC THT LED round mono-color color lens

Order.- No. **151051RS11000**

Size: 5 mm



COMPLIANT
RoHS&REACH
HALOGENFREE

SIZE	A4
------	----

This electronic component has been designed and developed for usage in general electronic equipment only. This product is not authorized for use in equipment where a higher safety standard and reliability standard is especially required or where a failure of the product is reasonably expected to cause severe personal injury or death, unless the parties have executed an agreement specifically governing such use. Moreover Würth Elektronik eiSos GmbH & Co KG products are neither designed nor intended for use in areas such as military, aerospace, aviation, nuclear control, submarine, transportation (automotive control, train control, ship control), transportation signal, disaster prevention, medical, public information network etc.. Würth Elektronik eiSos GmbH & Co KG must be informed about the intent of such usage before the design-in stage. In addition, sufficient reliability evaluation checks for safety must be performed on every electronic component which is used in electrical circuits that require high safety and reliability functions or performance.

H Soldering Specifications:



H1: Classification Wave Soldering Profile:

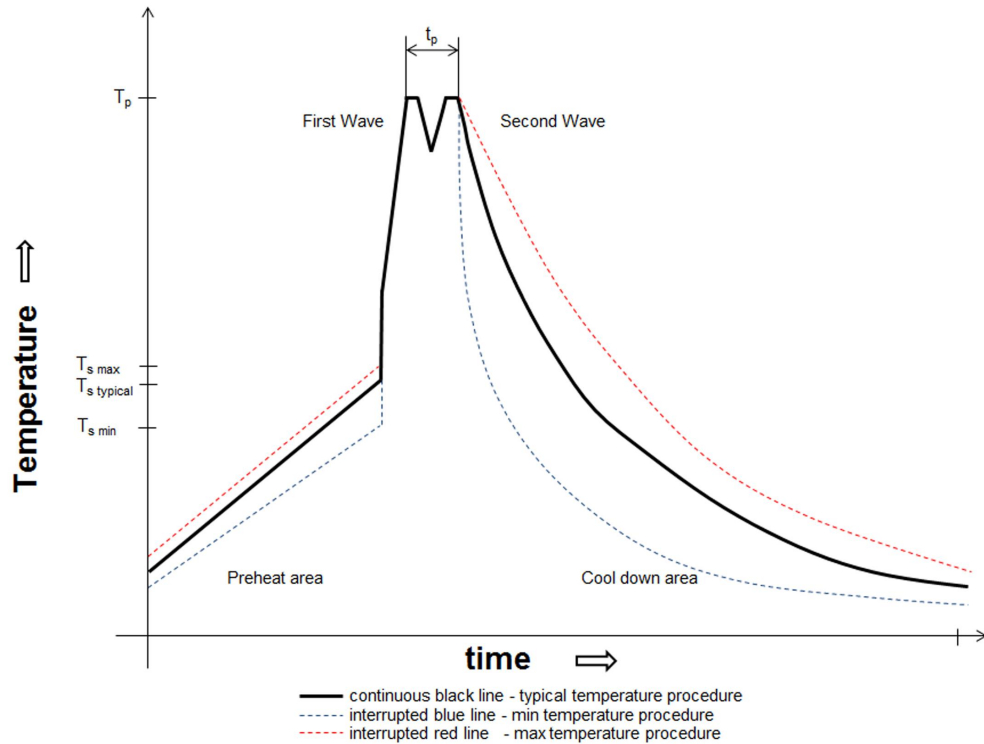

H2: Classification Wave Profile

Profile Feature	Pb-Free Assembly	Sn-Pb Assembly
Preheat - Temperature Min ($T_{s \min}$) - Temperature Typical ($T_{s \text{ typical}}$) - Temperature Max ($T_{s \max}$) - Time (t_p) from ($T_{s \min}$ to $T_{s \max}$)	100°C 120°C 130°C 70 seconds	100°C 120°C 130°C 70 seconds
Δ preheat to max Temperature	150°C max.	150°C max.
Peak temperature (T_p)	245°C - 260°C	235°C - 260°C
Time of actual peak temperature (t_p)	5-8 seconds max.	3-6 seconds max.
Ramp-down rate - Min - Typical - Max	~ 2 K/s ~ 3.5 K/s ~ 5 K/s	~ 2 K/s ~ 3.5 K/s ~ 5 K/s
Time 25°C to 25°C	4 minutes	4 minutes
Applied cycles	1 cycle max.	1 cycle max.

REV	DATE	BY	CHECKED	Projection	DESCRIPTION	SIZE
2.6	2015-03-23	SSt	HOe		WL-TMRC THT LED round mono-color color lens	A4
2.5	2014-11-03	SSt	ZAn			
2.4	2014-03-17	SSt	SSt		Order.- No. 151051RS11000 Size: 5 mm	A4
2.3	2013-12-09	SSt	PLD			
2.2	2013-10-08	SSt	PLD			
2.1	2013-09-10	SSt	SSt			
2.0	2013-07-30	SSt	PLD			
REV	DATE	BY	CHECKED			

This electronic component has been designed and developed for usage in general electronic equipment only. This product is not authorized for use in equipment where a higher safety standard and reliability standard is especially required or where a failure of the product is reasonably expected to cause severe personal injury or death, unless the parties have executed an agreement specifically governing such use. Moreover Würth Elektronik eiSos GmbH & Co KG products are neither designed nor intended for use in areas such as military, aerospace, aviation, nuclear control, submarine, transportation (automotive control, train control, ship control), transportation signal, disaster prevention, medical, public information network etc.. Würth Elektronik eiSos GmbH & Co KG must be informed about the intent of such usage before the design-in stage. In addition, sufficient reliability evaluation checks for safety must be performed on every electronic component which is used in electrical circuits that require high safety and reliability functions or performance.

I Cautions and Warnings:

The following conditions apply to all goods within the product series of WL-TMRC of Würth Elektronik eiSos GmbH & Co. KG:

General:

All recommendations according to the general technical specifications of the data sheet have to be complied with.

The usage and operation of the product within ambient conditions, which probably alloy or harm the component surface, has to be avoided.

If the product is potted in customer applications, the potting material might shrink during and after hardening. The product is exposed to the pressure of the potting material with the effect that the LED body, pins or termination is possibly damaged by this pressure and so the electrical as well as the mechanical characteristics are endangered to be affected. After the potting material is cured, the LED body, pins or termination of the product have to be checked if any reduced electrical or mechanical functions or destructions have occurred.

The responsibility for the applicability of customer specific products and use in a particular customer design is always within the authority of the customer. All technical specifications for standard products do also apply to customer specific products.

Washing varnish agent that is used during the production to clean the customer application might damage or change the characteristics of the LED body, pins or termination. The washing varnish agent could have a negative effect on the long term function of the product.

Direct mechanical impact to the product shall be prevented as the material of the LED body, pins or termination could flake or in the worst case it could break.

The standard deliveries include values in the range and limitation as defined in the Electrical & Optical Properties specified in the datasheet. On each reel, only one bin is sorted and taped. The bin is defined on intensity, chromaticity coordinate or wavelength and forward voltage. In order to ensure highest availability, the reel binning of standard deliveries can vary. A single bin cannot be ordered. Please contact us in advance, if you need a particular bin sorting before placing your order to clarify the lead time, MOQ and pricing.



Product specific:

Follow all instructions mentioned in the data sheet, especially:

- The soldering profile has to be complied with according to the technical reflow/ or wave soldering specification, otherwise this will void the warranty.
- All products shall be used before the end of the period of 12 months based on the product date code, if not a 100% solderability can't be ensured.
- Violation of the technical product specifications such as exceeding the absolute maximum ratings will void the warranty.
- It is also recommended to return the LEDs to the original moisture proof bag and reseal the moisture proof bag again.
- Certain LED surfaces consist of soft material. Pressure on the top surface has to be handled carefully to prevent negative influence to the function and reliability of the LEDs.
- ESD prevention methods need to be applied for manual handling and processing by machinery.
- Resistors for protection are obligatory.
- Luminaires in operation could harm human vision or skin on a photo-biological level, therefore direct light impact has to be avoided. All products are additionally certified as risk groups 0 to 2 according to DIN EN 62471:2008

				Projection			DESCRIPTION	
2.6	2015-03-23	SSt	HOe				WL-TMRC THT LED round mono-color color lens	
2.5	2014-11-03	SSt	ZAn					
2.4	2014-03-17	SSt	SSt				Order.- No.	SIZE
2.3	2013-12-09	SSt	PLD				151051RS11000	A4
2.2	2013-10-08	SSt	PLD					
2.1	2013-09-10	SSt	SSt					
2.0	2013-07-30	SSt	PLD					
REV	DATE	BY	CHECKED				Size: 5 mm	

This electronic component has been designed and developed for usage in general electronic equipment only. This product is not authorized for use in equipment where a higher safety standard and reliability standard is especially required or where a failure of the product is reasonably expected to cause severe personal injury or death, unless the parties have executed an agreement specifically governing such use. Moreover Würth Elektronik eiSos GmbH & Co KG products are neither designed nor intended for use in areas such as military, aerospace, aviation, nuclear control, submarine, transportation (automotive control, train control, ship control), transportation signal, disaster prevention, medical, public information network etc.. Würth Elektronik eiSos GmbH & Co KG must be informed about the intent of such usage before the design-in stage. In addition, sufficient reliability evaluation checks for safety must be performed on every electronic component which is used in electrical circuits that require high safety and reliability functions or performance.

J Important Notes:

The following conditions apply to all goods within the product range of Würth Elektronik eiSos GmbH & Co. KG:

1. General Customer Responsibility

Some goods within the product range of Würth Elektronik eiSos GmbH & Co. KG contain statements regarding general suitability for certain application areas. These statements about suitability are based on our knowledge and experience of typical requirements concerning the areas, serve as general guidance and cannot be estimated as binding statements about the suitability for a customer application. The responsibility for the applicability and use in a particular customer design is always solely within the authority of the customer. Due to this fact it is up to the customer to evaluate, where appropriate to investigate and decide whether the device with the specific product characteristics described in the product specification is valid and suitable for the respective customer application or not.

2. Customer Responsibility related to Specific, in particular Safety-Relevant Applications

It has to be clearly pointed out that the possibility of a malfunction of electronic components or failure before the end of the usual lifetime cannot be completely eliminated in the current state of the art, even if the products are operated within the range of the specifications.

In certain customer applications requiring a very high level of safety and especially in customer applications in which the malfunction or failure of an electronic component could endanger human life or health it must be ensured by most advanced technological aid of suitable design of the customer application that no injury or damage is caused to third parties in the event of malfunction or failure of an electronic component.

Therefore, customer is cautioned to verify that data sheets are current before placing orders. The current data sheets can be downloaded at www.we-online.com.

3. Best Care and Attention

Any product-specific notes, cautions and warnings must be strictly observed. Any disregard will result in the loss of warranty.

4. Customer Support for Product Specifications

Some products within the product range may contain substances which are subject to restrictions in certain jurisdictions in order to serve specific technical requirements. Necessary information is available on request. In this case the field sales engineer or the internal sales person in charge should be contacted who will be happy to support in this matter.

5. Product R&D

Due to constant product improvement product specifications may change from time to time. As a standard reporting procedure of the Product Change Notification (PCN) according to the JEDEC-Standard inform about minor and major changes. In case of further queries regarding the PCN, the field sales engineer or the internal sales person in charge should be contacted. The basic responsibility of the customer as per Section 1 and 2 remains unaffected.



6. Product Life Cycle

Due to technical progress and economical evaluation we also reserve the right to discontinue production and delivery of products. As a standard reporting procedure of the Product Termination Notification (PTN) according to the JEDEC-Standard we will inform at an early stage about inevitable product discontinuance. According to this we cannot guarantee that all products within our product range will always be available. Therefore it needs to be verified with the field sales engineer or the internal sales person in charge about the current product availability expectancy before or when the product for application design-in disposal is considered. The approach named above does not apply in the case of individual agreements deviating from the foregoing for customer-specific products.



7. Property Rights

All the rights for contractual products produced by Würth Elektronik eiSos GmbH & Co. KG on the basis of ideas, development contracts as well as models or templates that are subject to copyright, patent or commercial protection supplied to the customer will remain with Würth Elektronik eiSos GmbH & Co. KG.

Würth Elektronik eiSos GmbH & Co. KG does not warrant or represent that any license, either expressed or implied, is granted under any patent right, copyright, mask work right, or other intellectual property right relating to any combination, application, or process in which Würth Elektronik eiSos GmbH & Co. KG components or services are used.

8. General Terms and Conditions

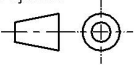
Unless otherwise agreed in individual contracts, all orders are subject to the current version of the "General Terms and Conditions of Würth Elektronik eiSos Group", last version available at www.we-online.com.

				Projection			DESCRIPTION		
2.6	2015-03-23	SSt	HOe				WL-TMRC THT LED round mono-color color lens		
2.5	2014-11-03	SSt	ZAn						
2.4	2014-03-17	SSt	SSt				Order.- No.		SIZE
2.3	2013-12-09	SSt	PLD				151051RS11000		A4
2.2	2013-10-08	SSt	PLD				Size: 5 mm		
2.1	2013-09-10	SSt	SSt						
2.0	2013-07-30	SSt	PLD						
REV	DATE	BY	CHECKED						

Данный компонент на территории Российской Федерации

Вы можете приобрести в компании MosChip.

Для оперативного оформления запроса Вам необходимо перейти по данной ссылке:

<http://moschip.ru/get-element>

Вы можете разместить у нас заказ для любого Вашего проекта, будь то серийное производство или разработка единичного прибора.

В нашем ассортименте представлены ведущие мировые производители активных и пассивных электронных компонентов.

Нашей специализацией является поставка электронной компонентной базы двойного назначения, продукции таких производителей как XILINX, Intel (ex.ALTERA), Vicor, Microchip, Texas Instruments, Analog Devices, Mini-Circuits, Amphenol, Glenair.

Сотрудничество с глобальными дистрибьюторами электронных компонентов, предоставляет возможность заказывать и получать с международных складов практически любой перечень компонентов в оптимальные для Вас сроки.

На всех этапах разработки и производства наши партнеры могут получить квалифицированную поддержку опытных инженеров.

Система менеджмента качества компании отвечает требованиям в соответствии с ГОСТ Р ИСО 9001, ГОСТ РВ 0015-002 и ЭС РД 009

Офис по работе с юридическими лицами:

105318, г.Москва, ул.Щербаковская д.3, офис 1107, 1118, ДЦ «Щербаковский»

Телефон: +7 495 668-12-70 (многоканальный)

Факс: +7 495 668-12-70 (доб.304)

E-mail: info@moschip.ru

Skype отдела продаж:

moschip.ru

moschip.ru_4

moschip.ru_6

moschip.ru_9