

# Mechatronic Analog Timer

# H3AM

Please read and understand this catalog before purchasing the products. Please consult your OMRON representative if you have any questions or comments. Refer to *Safety Precautions* on page 7.

## Large Setting Dial and Moving Pointers Ideal for Easy Operation and Monitoring

- Incorporating an easy-to-see large setting dial with moving pointers.
- Wide time-setting range of 0.2 s to 60 h (available through three time-range model types)
- Wide AC power supply range (100 to 240 VAC)
- IP65 watertight and dust-tight front panel.
- Approved by UL and CSA.
- Conforms to EN61812-1 and IEC60664-1 4 kV for Low Voltage, and EMC Directives.
- Conforms to EMC standards.
- Six-language instruction manual provided.
- Programmable contact enables the building of a self-holding relay circuit as well as built-in instantaneous contact. (-NS)
- Memory retention (-NSR)
- Finger protection terminal block
- Enables easy sequence checks through instantaneous outputs for a zero set value at any time range.



## Model Number Legend

H3AM - NS  -  -   
                   1      2      3

### 1. Resetting System

- None: Self-resetting
- R: Electric resetting

### 2. Time Range

- A: 0.5 s to 30 h
- B: 1 s to 60 h
- C: 0.2 s to 12 h

### 3. Accessory

- None: Without accessory
- 300: Waterproof Packing (Y92S-35) provided

## Ordering Information

### ■ List of Models

Rated supply voltage	Resetting system (See note.)	Control output	Time range		
			0.5 s to 30 h (30 s, 3 min, 30 min, 3 h, 30 h)	1 s to 60 h (60 s, 6 min, 60 min, 6 h, 60 h)	0.2 s to 12 h (12 s, 120 s, 12 min, 120 min, 12 h)
100 to 240 VAC	Self-resetting	DPDT contact output (Time-limit output SPDT and switchable SPDT (time-limit ↔ instantaneous))	H3AM-NS-A	H3AM-NS-B	H3AM-NS-C
	Electric resetting	DPDT contact output (Time-limit output SPDT and instantaneous output SPDT)	H3AM-NSR-A	H3AM-NSR-B	H3AM-NSR-C

**Note:** The operation of the instantaneous contacts differs for the self-resetting and electric resetting systems. Refer to *Timing Charts* on page 5 for details.

## ■ Accessory (Order Separately)

Item	Model
Waterproof Packing	Y92S-35 (See note.)

Note: Supplied with H3AM-NS□-□-300 models.

## Specifications

### ■ General

Operating mode	ON-delay
Screw tightening torque	0.98 N·m (10 kgf) max.
Input type	Voltage input
Output type	Relay: DPDT
Mounting method	Flush/Panel mounting, no restriction on mounting angle.
Approved standards	UL 508, CSA C22.2 No. 14 Conforms to EN61812-1, IEC60664-1 4 kV/2, VDE0106/P100 Output category according to IEC60947-5-1

### ■ Time Ranges

Model	Full scale on dial	Set time unit					
		s	10 s	min	10 min	h (hour)	10 h (hour)
H3AM-□□□-A	3	---	0.5 to 30 s	0.05 to 3 min	0.5 to 30 min	0.05 to 3 h	0.5 to 30 h
H3AM-□□□-B	6	---	1 to 60 s	0.1 to 6 min	1 to 60 min	0.1 to 6 h	1 to 60 h
H3AM-□□□-C	12	0.2 to 12 s	2 to 120 s	0.2 to 12 min	2 to 120 min	0.2 to 12 h	---

Note: Instantaneous output is obtained by turning the time setting knob below "0" until the time setting knob stops.

### ■ Ratings

Rated supply voltage	100 to 240 VAC (50/60 Hz)
Operating voltage range	85% to 110% of rated supply voltage
Power reset (-NS)	Minimum power-opening time: 0.5 s
Reset input time (-NSR)	Minimum input time: 0.5 s
Reset voltage range (-NSR)	H level: 85 to 264 VAC L level: 0 to 10 VAC
Power consumption	Approx. 9 VA (Approx. 5 W)
Control output	Contact output: 5 A at 250 VAC, resistive load ( $\cos\phi = 1$ )
Ambient temperature	Operating: $-10^{\circ}\text{C}$ to $55^{\circ}\text{C}$ (with no icing) Storage: $-25^{\circ}\text{C}$ to $65^{\circ}\text{C}$ (with no icing)
Ambient humidity	Operating: 35% to 85%

Note: The minimum applicable load:

H3AM-NS: 10 mA at 5 VDC (failure level: P, reference value)

H3AM-NSR: 100 mA at 5 VDC (failure level: P, reference value)

## ■ Characteristics

<b>Accuracy of operating time</b>	±0.7% FS max.
<b>Setting error</b>	±2% FS max.
<b>Reset time</b>	Power reset: 0.5 s max. Reset input time: 0.5 s max.
<b>Influence of voltage</b>	±1% FS max.
<b>Influence of temperature</b>	±2% FS max.
<b>Insulation resistance</b>	100 MΩ max. (at 500 VDC)
<b>Dielectric strength</b>	2,000 VAC (50/60 Hz) for 1 min between exposed non-current-carrying metal parts and current-carrying metal parts 2,000 VAC (50/60 Hz) for 1 min between the operating circuit and control output terminals 1,000 VAC (50/60 Hz) for 1 min between the operating power supply circuit and reset input circuit (H3AM-NSR only) 1,000 VAC (50/60 Hz) for 1 min between contacts not located next to each other 2,000 VAC (50/60 Hz) for 1 min between contacts of opposite poles
<b>Impulse withstand voltage</b>	3 kV between power terminals 4.5 kV between exposed non-current-carrying metal parts and current-carrying metal parts
<b>Noise immunity</b>	±1.5 kV (between power terminals) square-wave noise by a noise simulator (pulse width: 100 ns/1 μs, 1-ns rise)
<b>Static immunity</b>	Malfunction: 8 kV Destruction: 15 kV
<b>Vibration resistance</b>	Destruction: 10 to 55 Hz, 0.75-mm single amplitude for 2 cycles each in 3 directions (8 min per cycle) Malfunction: 10 to 55 Hz, 0.5-mm single amplitude for 2 cycles each in 3 directions (8 min per cycle)
<b>Shock resistance</b>	Destruction: 300 m/s <sup>2</sup> 3 times each in 6 directions Malfunction: 150 m/s <sup>2</sup> (100 m/s <sup>2</sup> in the front/back direction) 3 times each in 6 directions
<b>Life expectancy</b>	Mechanical: 5,000,000 times min. (under no load at 1,800 times/h) Electrical: 100,000 times min. (5-A at 250 VAC, resistive load at 1,800 times/h)
<b>Motor life expectancy</b>	20,000 h
<b>EMC</b>	(EMI): EN61812-1 Emission Enclosure: EN55011 class A Emission AC Mains: EN55011 class A (EMS): EN61812-1 Immunity ESD: IEC61000-4-2: 6 kV contact discharge 8 kV air discharge Immunity RF-interference: IEC61000-4-3: 10 V/m (Amplitude-modulated, 80 MHz to 1 GHz) 10 V/m (Pulse-modulated, 900 MHz±5 MHz) Immunity Power Frequency Magnetic Fields: IEC61000-4-8: 30 A/m (50 Hz) Immunity Conducted Disturbance: IEC61000-4-6: 10 V (0.15 to 80 MHz) Immunity Burst: IEC61000-4-4: 2 kV power-line 2 kV I/O signal-line Immunity Surge: IEC61000-4-5: 1 kV line to line 2 kV line to ground
<b>Enclosure rating</b>	IP65 (front panel only) (See note.) IP20 (terminal section)
<b>Weight</b>	Approx. 350 g

**Note:** A separately sold waterproof packing (Y92S-35) is necessary to ensure IP65 waterproofing between the Timer and installation panel.  
The H3AM-NS□-□-300 model with waterproof packing is available.

# Nomenclature

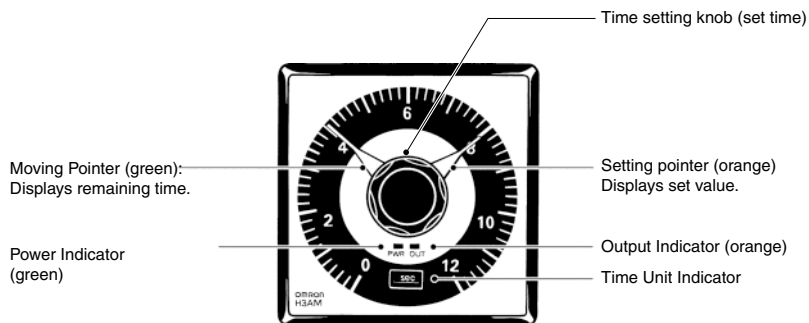

**Note:** The scale goes up to "3" with the H3AM-□-A and up to "6" with the H3AM-□-B.

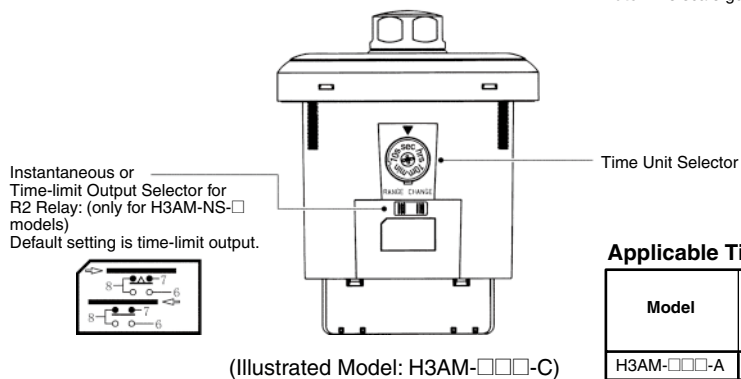

### Applicable Time Unit

Model	Full scale on dial	Applicable time unit					
		s	10 s	min	10 min	h	10 h
H3AM-□□□-A	3	No	Yes	Yes	Yes	Yes	Yes
H3AM-□□□-B	6	No	Yes	Yes	Yes	Yes	Yes
H3AM-□□□-C	12	Yes	Yes	Yes	Yes	Yes	No

# Operations

## ■ Timing Charts

### H3AM-NS

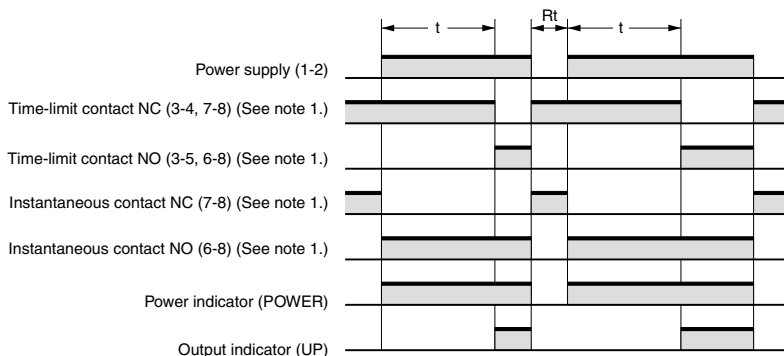

- Note: 1.** The R2 contacts (7-8 and 6-8) are programmable and can be set to either instantaneous or time-limit contacts using the switch located on the bottom of the Timer.
- 2.**  $Rt$  is the reset time and  $t$  is the set time.

### H3AM-NSR

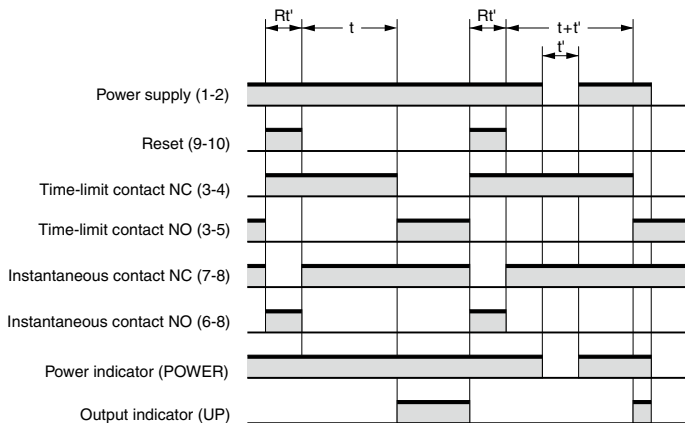

- Note:**  $t$  is the set time,  $Rt'$  is the reset application time, and  $t'$  is the power interruption time.

## Dimensions

Note: All units are in millimeters unless otherwise indicated.

### H3AM (Flush Mounting)

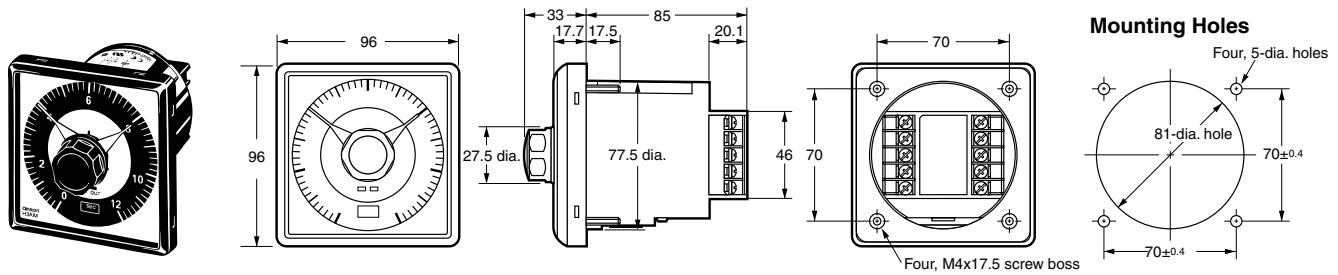

Note: Tightening torque for panel mounting is as follows:  
300 m N·m ±50 m N·m

## ■ Accessories (Order Separately)

### Waterproof Packing

(Provided with H3AM-NS□-□-300 models.)

Y92S-35

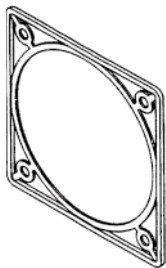

Note: Use Waterproof Packing to provide a level of water protection that complies with IP65 standards. Depending on the operating environment, the Waterproof Packing may deteriorate, contract, or harden and so regular replacement is recommended.

## Installation

### ■ Internal Connections and Terminal Arrangement

H3AM-NS

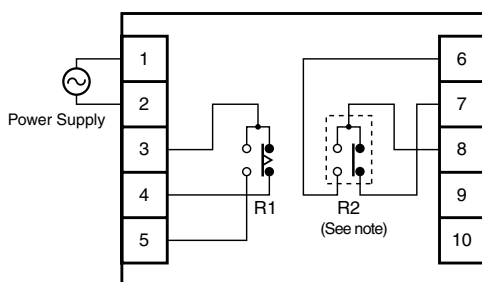

H3AM-NSR

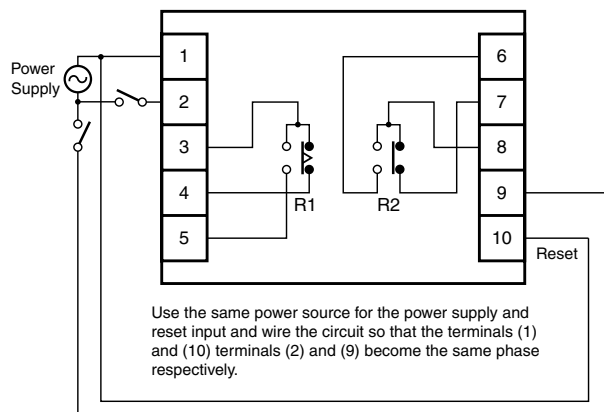

Note: The R2 relay can be switched between instantaneous and time-limit contacts and thus the contact symbol is shown as follows:

# Safety Precautions

## ■ Precautions for Safe Use

Observe the following items to ensure the safe use of this product.

### Environmental Precautions

- Store the H3AM within the specified ratings. If the H3AM has been stored at temperatures  $-10^{\circ}\text{C}$  or lower, let it stand for 3 hours or longer at room temperature before turning ON the power supply.
- Use the H3AM within the specified ratings for operating temperature and humidity.
- Do not operate the H3AM in locations subject to sudden or extreme changes in temperature, or locations where high humidity may result in condensation.
- Do not use the H3AM in locations subject to vibrations or shock. Extended use in such locations may result in damage due to stress.
- Do not use the H3AM in locations subject to excessive dust, corrosive gas, or direct sunlight.
- Install the H3AM well away from any sources of static electricity, such as pipes transporting molding materials, powders, or liquids.
- Do not use organic solvents (such as paint thinner or benzene), strong alkaline, or strong acids because they will damage the external finish.

### Usage Precautions

- Install a switch or circuit breaker that allows the operator to immediately turn OFF the power, and label it to clearly indicate its function.
- Be sure to wire the terminals correctly.
- Do not install input lines in the same duct or conduit as power supply or other high-voltage lines. Doing so may result in malfunction due to noise. Separate the input lines from high-voltage lines.
- Internal elements may be destroyed if a voltage outside the rated voltage is applied.
- Maintain voltage fluctuations in the power supply within the specified range.
- Use a switch, relay, or other contact so that the rated power supply voltage will be reached within 0.1 s. If the power supply voltage is not reached quickly enough, the H3AM may malfunction or outputs may be unstable.

## ■ Precautions for Correct Use

### Changing Switch Settings

Be sure to adjust the time unit selector and instantaneous or time-limit output selector for R2 relay only before the Timer is turned ON, otherwise the Timer may be damaged or malfunction.

Be sure to set the time only when Timer has stopped, otherwise the Timer may malfunction.

### Setting the Operating Time

Do not turn the time setting knob beyond the permissible range. If a precise time setting is required, check the operation of the Timer in trial operation before the Timer is put in actual operation.

Before using the H3AM-NSR, apply voltage between terminals 9 and 10 to reset the operation.

When changing the setting time of the H3AM-NSR to a longer time value, be sure to apply voltage between terminals 9 and 10 during the change.

### Others

When mounting the Timer on a panel, evenly tighten the Timer to a specified torque. If the Timer using waterproof packing is tightened to a torque other than the specified value, required waterproof properties will not be achieved.

If the Timer is mounted on a control panel, dismount the Timer from the control panel or short-circuit the circuitry before carrying out a voltage withstand test between the electric circuitry and non current-carrying metal part of the machine, in order to prevent the internal circuitry of the Timer from damage.

The internal elements may be damaged if a voltage other than the rated supply voltage is applied.

## ■ Precautions for EN61812-1 Conformance

The H3AM as a built-in timer conforms to EN61812-1 provided that the following conditions are satisfied:

The output section of the H3AM is provided only with basic isolation.

The H3AM itself is designed according to the following:

- Overvoltage category III
- Pollution degree 2

On the above basis:

Operation parts on the front and bottom: Reinforced isolation

With clearance of 5.5 mm and creepage distance of 5.5 mm at 240 VAC

Output: Basic isolation

With clearance of 3.0 mm and creepage distance of 3.0 mm at 240 VAC

ALL DIMENSIONS SHOWN ARE IN MILLIMETERS.

To convert millimeters into inches, multiply by 0.03937. To convert grams into ounces, multiply by 0.03527.

In the interest of product improvement, specifications are subject to change without notice.

## Read and Understand This Catalog

Please read and understand this catalog before purchasing the products. Please consult your OMRON representative if you have any questions or comments.

## Warranty and Limitations of Liability

### WARRANTY

OMRON's exclusive warranty is that the products are free from defects in materials and workmanship for a period of one year (or other period if specified) from date of sale by OMRON.

OMRON MAKES NO WARRANTY OR REPRESENTATION, EXPRESS OR IMPLIED, REGARDING NON-INFRINGEMENT, MERCHANTABILITY, OR FITNESS FOR PARTICULAR PURPOSE OF THE PRODUCTS. ANY BUYER OR USER ACKNOWLEDGES THAT THE BUYER OR USER ALONE HAS DETERMINED THAT THE PRODUCTS WILL SUITABLY MEET THE REQUIREMENTS OF THEIR INTENDED USE. OMRON DISCLAIMS ALL OTHER WARRANTIES, EXPRESS OR IMPLIED.

### LIMITATIONS OF LIABILITY

OMRON SHALL NOT BE RESPONSIBLE FOR SPECIAL, INDIRECT, OR CONSEQUENTIAL DAMAGES, LOSS OF PROFITS, OR COMMERCIAL LOSS IN ANY WAY CONNECTED WITH THE PRODUCTS, WHETHER SUCH CLAIM IS BASED ON CONTRACT, WARRANTY, NEGLIGENCE, OR STRICT LIABILITY.

In no event shall responsibility of OMRON for any act exceed the individual price of the product on which liability is asserted.

IN NO EVENT SHALL OMRON BE RESPONSIBLE FOR WARRANTY, REPAIR, OR OTHER CLAIMS REGARDING THE PRODUCTS UNLESS OMRON'S ANALYSIS CONFIRMS THAT THE PRODUCTS WERE PROPERLY HANDLED, STORED, INSTALLED, AND MAINTAINED AND NOT SUBJECT TO CONTAMINATION, ABUSE, MISUSE, OR INAPPROPRIATE MODIFICATION OR REPAIR.

## Application Considerations

### SUITABILITY FOR USE

OMRON shall not be responsible for conformity with any standards, codes, or regulations that apply to the combination of products in the customer's application or use of the product.

At the customer's request, OMRON will provide applicable third party certification documents identifying ratings and limitations of use that apply to the products. This information by itself is not sufficient for a complete determination of the suitability of the products in combination with the end product, machine, system, or other application or use.

The following are some examples of applications for which particular attention must be given. This is not intended to be an exhaustive list of all possible uses of the products, nor is it intended to imply that the uses listed may be suitable for the products:

- Outdoor use, uses involving potential chemical contamination or electrical interference, or conditions or uses not described in this catalog.
- Nuclear energy control systems, combustion systems, railroad systems, aviation systems, medical equipment, amusement machines, vehicles, safety equipment, and installations subject to separate industry or government regulations.
- Systems, machines, and equipment that could present a risk to life or property.

Please know and observe all prohibitions of use applicable to the products.

NEVER USE THE PRODUCTS FOR AN APPLICATION INVOLVING SERIOUS RISK TO LIFE OR PROPERTY WITHOUT ENSURING THAT THE SYSTEM AS A WHOLE HAS BEEN DESIGNED TO ADDRESS THE RISKS, AND THAT THE OMRON PRODUCT IS PROPERLY RATED AND INSTALLED FOR THE INTENDED USE WITHIN THE OVERALL EQUIPMENT OR SYSTEM.

## Disclaimers

### CHANGE IN SPECIFICATIONS

Product specifications and accessories may be changed at any time based on improvements and other reasons.

It is our practice to change model numbers when published ratings or features are changed, or when significant construction changes are made. However, some specifications of the product may be changed without any notice. When in doubt, special model numbers may be assigned to fix or establish key specifications for your application on your request. Please consult with your OMRON representative at any time to confirm actual specifications of purchased product.

### DIMENSIONS AND WEIGHTS

Dimensions and weights are nominal and are not to be used for manufacturing purposes, even when tolerances are shown.

### ERRORS AND OMISSIONS

The information in this catalog has been carefully checked and is believed to be accurate; however, no responsibility is assumed for clerical, typographical, or proofreading errors, or omissions.

### PERFORMANCE DATA

Performance data given in this catalog is provided as a guide for the user in determining suitability and does not constitute a warranty. It may represent the result of OMRON's test conditions, and the users must correlate it to actual application requirements. Actual performance is subject to the OMRON Warranty and Limitations of Liability.

### PROGRAMMABLE PRODUCTS

OMRON shall not be responsible for the user's programming of a programmable product, or any consequence thereof.

### COPYRIGHT AND COPY PERMISSION

This catalog shall not be copied for sales or promotions without permission.

This catalog is protected by copyright and is intended solely for use in conjunction with the product. Please notify us before copying or reproducing this catalog in any manner, for any other purpose. If copying or transmitting this catalog to another, please copy or transmit it in its entirety.



## Данный компонент на территории Российской Федерации

### Вы можете приобрести в компании MosChip.

Для оперативного оформления запроса Вам необходимо перейти по данной ссылке:

<http://moschip.ru/get-element>

Вы можете разместить у нас заказ для любого Вашего проекта, будь то серийное производство или разработка единичного прибора.

В нашем ассортименте представлены ведущие мировые производители активных и пассивных электронных компонентов.

Нашей специализацией является поставка электронной компонентной базы двойного назначения, продукции таких производителей как XILINX, Intel (ex.ALTERA), Vicor, Microchip, Texas Instruments, Analog Devices, Mini-Circuits, Amphenol, Glenair.

Сотрудничество с глобальными дистрибьюторами электронных компонентов, предоставляет возможность заказывать и получать с международных складов практически любой перечень компонентов в оптимальные для Вас сроки.

На всех этапах разработки и производства наши партнеры могут получить квалифицированную поддержку опытных инженеров.

Система менеджмента качества компании отвечает требованиям в соответствии с ГОСТ Р ИСО 9001, ГОСТ РВ 0015-002 и ЭС РД 009

### Офис по работе с юридическими лицами:

105318, г.Москва, ул.Щербаковская д.3, офис 1107, 1118, ДЦ «Щербаковский»

Телефон: +7 495 668-12-70 (многоканальный)

Факс: +7 495 668-12-70 (доб.304)

E-mail: [info@moschip.ru](mailto:info@moschip.ru)

Skype отдела продаж:

moschip.ru

moschip.ru\_4

moschip.ru\_6

moschip.ru\_9