

**Heavy Duty
Cylindrical
MIL-C-22992
QWLD**

Amphenol® Heavy Duty Cylindrical Connectors

MIL-C-22992, QWLD



wall mount receptacle



thru bulkhead receptacle



cable connecting plug



straight plug



box mount receptacle



jam nut receptacle
(box mount)



jam nut receptacle
(wall mount)

Amphenol® QWLD Series heavy duty cylindrical connectors provide reliable power and control functions in hostile environments where ordinary connectors cannot survive.

Design features of this connector series provide:

- **High Durability** - water and explosion proof, resistant to abrasion, corrosion, vibration and shock
- **Quick, Positive Mating** - double stub threads per MIL-STD-1373 for fast coupling, easily cleaned
- **Selection** - over 300 industrial and MS-approved insert patterns available, including coaxial and thermocouple

On the drilling platform in the North Sea, pump and motor generator controls run smoothly, although constantly exposed to salt spray.

At Prudhoe Bay where the nights are six months long, portable lighting systems permit operation regardless of temperature plummeting to 50° below zero.

The circus ferris wheel runs continuously despite the fact that it has rained for five days and all power connections are lying in six inches of mud.

These situations are typical of the extreme conditions under which thousands of Amphenol QWLD connectors are operating daily. Outstanding design features that make these cylindricals a necessity for difficult applications include:

- Alumilite 225* hard anodic finish for abrasion and corrosion resistance or conductive cadmium plate
- Resilient inserts for moisture sealing, positive proof against shock and vibration
- Sealing gaskets at every joint for water-proof assembly
- Cable strain relief provided by clamp bar type accessories
- Left hand accessory threads to prevent damage from disconnect torque applied in the wrong direction
- Closed entry socket contact design in solder or replaceable crimp contacts

* Registered trademark of Aluminum Company of America

MIL-C-22992, QWLD

how to order

MS-APPROVED CONNECTORS

To illustrate the ordering procedure, part number MS17343R20N27PW is shown as follows:

| | | | | | | | |
|----------------|-------------|-----------|----------|-----------|----------|----------|--|
| | PART NUMBER | | | | | | |
| <u>MS17343</u> | <u>R</u> | <u>20</u> | <u>N</u> | <u>27</u> | <u>P</u> | <u>W</u> | |
| 1 | 2 | 3 | 4 | 5 | 6 | 7 | |

1. MS Number -

- MS17343 designates wall mount receptacle
- MS17344 designates straight plug
- MS17345 designates cable connecting plug
- MS17346 designates box mount receptacle
- MS17347 designates jam nut receptacle with rear accessory threads (wall mount)
- MS17348 designates jam nut receptacle (box mount)

2. Class -

- C designates pressurized - used where circuit integrity is protected by a pressure differential
- R designates environmental - see table, page 1

3. Shell Size -

available in shell sizes 12 through 44. Refer to pages 53 through 59 for dimensional data.

4. Shell Finish -

C for conductive or N for non-conductive

5. Insert Arrangement -

current MS insert arrangements are shown in black in the QWLD insert arrangements section of this catalog. Only these arrangements are available in MS-approved connectors.

6. Contact Type -

P for pin, S for socket

7. Alternate Insert Rotation -

used to prevent cross-mating of connectors. Absence of a letter in this space indicates normal (0°) position of the insert. Refer to page 26 for alternate insert rotation illustrations.

QWLD INDUSTRIAL VERSIONS

These heavy duty connectors are identical to MS-approved types except for the added flexibility of connector shell and contact type and finish options, plus added insert arrangements. To illustrate the ordering procedure, part number 10-194622-14S is shown as follows:

| | | | | | |
|-----------|-------------|------------|----------|--------------|----------|
| | PART NUMBER | | | | |
| <u>10</u> | <u>-</u> | <u>194</u> | <u>6</u> | <u>22-14</u> | <u>S</u> |
| <u>1</u> | | <u>2</u> | <u>3</u> | <u>4</u> | <u>5</u> |

1. Base Number Prefix -

- used to define connector shell finish and contact type and finish
- 10 - Solder type contacts, silver plated
- 75- Crimp type contacts, silver plated
- 81- Crimp type contacts, plated .0001 gold over silver
- 82- Crimp type contacts for MIL-C-13777 cable, silver plated
- 83- Crimp type contacts for MIL-C-13777 cable, plated .0001 gold over silver
- 85- Crimp type contacts, plated .00005 gold over silver
- All above prefix numbers utilize connector shells with Alumilite* non-conductive finish*
- 88- Solder type contacts, silver plated. Connector shell utilizes olive drab cadmium plate over nickel conductive finish.

2. Base Number -

QWLD Series Heavy Duty Cylindrical Connector

3. Shell Style -

- 0 designates wall mount receptacle
- 1 designates cable connecting plug
- 2 designates box mount receptacle
- 3 designates jam nut receptacle with rear accessory threads (wall mount)
- 4 designates thru bulkhead receptacle
- 6 designates straight plug
- 9 designates jam nut receptacle (box mount)

4. Shell Size/Insert Arrangement -

Amphenol® QWLD connectors are available in equivalent MS shell sizes with all current MS insert arrangements as well as a large selection of special arrangements for power and signal circuits. Select the required insert arrangement number from those shown in black (MS arrangements) or red (industrial arrangements).

5. Contact Type/Alternate Insert Rotation -

P for pin, S for socket. When an alternate position of the connector insert is required to prevent cross-mating of connectors, a different letter (other than P or S) is used. Select from the table below the Amphenol® letter which indicates both type of contact and insert rotation desired. Refer to page 26 for alternate insert rotation illustrations.

| Pin Contacts | | Socket Contacts | |
|--------------|-------------------|-----------------|-------------------|
| MS Letters | Amphenol® Letters | MS Letters | Amphenol® Letters |
| P | P (normal) | S | S (normal) |
| PW | G | SW | H |
| PX | I | SX | J |
| PY | K | SY | L |
| PZ | M | SZ | N |

Alumilite is a registered trademark of Aluminum Co. of America

MIL-C-22992, QWLD

insert arrangements

| Insert Arrangement | | Service Rating | Total Contacts | Contact Size | | | | |
|--------------------|------------|-----------------------------------|----------------|--------------|---|---|----|----|
| MS Approved | Industrial | | | 0 | 4 | 8 | 12 | 16 |
| 12-5 | | D | 1 | | | | 1 | |
| | 12-48 | A | 3 | | | | | 3 |
| | 12-49 | A | 2 | | | | | 2 |
| 14-3 | | A | 1 | | | 1 | | |
| | 14-53 | Inst. | 6 | | | | | 6 |
| 16-2 | | E | 1 | | | | 1 | |
| 16-7 | | A | 3 | | | 1 | | 2 |
| 16-9 | | A | 4 | | | | 2 | 2 |
| 16-10 | | A | 3 | | | | 3 | |
| 16-11 | | A | 2 | | | | 2 | |
| 16-12 | | A | 1 | 1 | | | | |
| 16-13 | | A | 2 | | | | 2 | |
| | 16-61 | A | 7 | | | | 7 | |
| 18-1 | | B, C, F, G = A; Bal. = Inst. | 10 | | | | | 10 |
| | 18-3 | D | 2 | | | | 2 | |
| 18-4 | | D | 4 | | | | | 4 |
| 18-5 | | D | 3 | | | | 2 | 1 |
| 18-6 | | D | 1 | 1 | | | | |
| 18-7 | | B | 1 | | | 1 | | |
| 18-8 | | A | 8 | | | | 1 | 7 |
| 18-9 | | Inst. | 7 | | | | 2 | 5 |
| | 18-10 | A | 4 | | | | 4 | |
| 18-11 | | A | 5 | | | | 5 | |
| | 18-12 | A | 6 | | | | | 6 |
| 18-13 | | A | 4 | | | 1 | 3 | |
| 18-14 | | A | 2 | | 1 | | | 1 |
| 18-15 | | A | 4 | | | | 4 | |
| 18-16 | | C | 1 | | | | 1 | |
| | 18-17 | Inst. | 7 | | | | 2 | 5 |
| | 18-19 | A | 10 | | | | | 10 |
| | 18-20 | A | 5 | | | | | 5 |
| | 18-22 | D | 3 | | | | | 3 |
| | 18-24 | B, C, F, G = A; Bal. = Inst. | 10 | | | | | 10 |
| | 18-29 | A | 5 | | | | | 5 |
| | 18-30 | A | 5 | | | | | 5 |
| | 18-31 | A | 5 | | | | | 5 |
| 20-2 | | D | 1 | 1 | | | | |
| | 20-3 | D | 3 | | | | 3 | |
| 20-4 | | D | 4 | | | | 4 | |
| | 20-6 | D | 3 | | | | | 3 |
| 20-7 | | A, B, H, G = D; C, D, E, F = A | 8 | | | | | 8 |
| 20-8 | | Inst. | 6 | | | 2 | | 4 |

| Insert Arrangement | | Service Rating | Total Contacts | Contact Size | | | | |
|--------------------|------------|-----------------------------------|----------------|--------------|---|---|----|----|
| MS Approved | Industrial | | | 0 | 4 | 8 | 12 | 16 |
| 20-9 | | H = D; Bal. = A | 8 | | | | 1 | 7 |
| | 20-11 | Inst. | 13 | | | | | 13 |
| | 20-12 | A | 2 | | 1 | | | 1 |
| 20-14 | | A | 5 | | | 2 | 3 | |
| 20-15 | | A | 7 | | | | 7 | |
| 20-16 | | A | 9 | | | | 2 | 7 |
| 20-17 | | A | 6 | | | | 5 | 1 |
| 20-18 | | A | 9 | | | | 3 | 6 |
| | 20-19 | A | 3 | | | 3 | | |
| | 20-20 | A | 4 | | 1 | | 3 | |
| 20-21 | | A | 9 | | | | 1 | 8 |
| 20-22 | | A | 6 | | | 3 | | 3 |
| | 20-23 | A | 2 | | | 2 | | |
| 20-24 | | A | 4 | | | 2 | | 2 |
| | 20-25 | Inst. | 13 | | | | | 13 |
| 20-27 | | A | 14 | | | | | 14 |
| 20-29 | | A | 17 | | | | | 17 |
| | 20-30 | Inst. | 13 | | | | | 13 |
| 20-33 | | A | 11 | | | | | 11 |
| | 22-1 | D | 2 | | | 2 | | |
| 22-2 | | D | 3 | | | 3 | | |
| | 22-4 | A | 4 | | | 2 | 2 | |
| 22-5 | | D | 6 | | | | 2 | 4 |
| | 22-6 | D | 3 | | | 2 | | 1 |
| 22-7 | | E | 1 | 1 | | | | |
| | 22-8 | E | 2 | | | | 2 | |
| 22-9 | | E | 3 | | | | 3 | |
| 22-10 | | E | 4 | | | | | 4 |
| 22-11 | | B | 2 | | | | | 2 |
| 22-12 | | D | 5 | | | 2 | | 3 |
| | 22-13 | E = D; A, B, C, D = A | 5 | | | | 4 | 1 |
| 22-14 | | A | 19 | | | | | 19 |
| 22-15 | | D = E; A, B, C, E, F = A | 6 | | | | 5 | 1 |
| | 22-16 | A | 9 | | | | 3 | 6 |
| 22-17 | | A = D; Bal. = A | 9 | | | | 1 | 8 |
| 22-18 | | A, B, F, G, H = D; C, D, E = A | 8 | | | | | 8 |
| 22-19 | | A | 14 | | | | | 14 |
| | 22-20 | A | 9 | | | | | 9 |
| 22-21 | | A | 3 | 1 | | | | 2 |
| 22-22 | | A | 4 | | | 4 | | |
| 22-23 | | H = D; Bal. = A | 8 | | | | 8 | |
| | 22-24 | C, D, E = D; A, B, F = A | 6 | | | | 2 | 4 |

MIL-C-22992, QWLD

insert arrangements

| Insert Arrangement | | Service Rating | Total Contacts | Contact Size | | | | |
|--------------------|------------|--|----------------|--------------|---|---|----|----|
| MS Approved | Industrial | | | 0 | 4 | 8 | 12 | 16 |
| 22-27 | | J = D; Bal. = A | 9 | | | 1 | | 8 |
| | 22-28 | A | 7 | | | | 7 | |
| | 22-33 | A, B, C, D = D; E, F, G = A | 7 | | | | | 7 |
| | 22-34 | D | 5 | | | | 3 | 2 |
| 22-36 | | H = D; Bal. = A | 8 | | | | 8 | |
| 24-2 | | D | 7 | | | | 7 | |
| | 24-3 | D | 7 | | | | 2 | 5 |
| | 24-5 | A | 16 | | | | | 16 |
| 24-6 | | A, G, H = D; Bal. = A | 8 | | | | 8 | |
| 24-7 | | A | 16 | | | | 2 | 14 |
| | 24-9 | A | 2 | | 2 | | | |
| 24-10 | | A | 7 | | | 7 | | |
| 24-11 | | A | 9 | | | 3 | 6 | |
| 24-12 | | A | 5 | | 2 | | 3 | |
| 24-16 | | A, B, F, G = D; C, D, E = A | 7 | | | 1 | 3 | 3 |
| | 24-17 | D | 5 | | | | 2 | 3 |
| 24-20 | | D | 11 | | | | 2 | 9 |
| 24-21 | | D | 10 | | | 1 | | 9 |
| 24-22 | | D | 4 | | | 4 | | |
| 24-27 | | E | 7 | | | | | 7 |
| 24-28 | | Inst. | 24 | | | | | 24 |
| 28-1 | | A, J, E = D; Bal. = A | 9 | | | 3 | 6 | |
| 28-2 | | D | 14 | | | | 2 | 12 |
| 28-3 | | E | 3 | | | 3 | | |
| 28-4 | | G, P, S = E; Bal. = D | 9 | | | | 2 | 7 |
| 28-5 | | D | 5 | | 2 | | 1 | 2 |
| | 28-6 | D | 3 | | 3 | | | |
| | 28-7 | D | 2 | | 2 | | | |
| 28-8 | | L, M = E; B = D; Bal. = A | 12 | | | | 2 | 10 |
| 28-9 | | D | 12 | | | | 6 | 6 |
| 28-10 | | G = D; Bal. = A | 7 | | 2 | 2 | 3 | |
| 28-11 | | A | 22 | | | | 4 | 18 |
| 28-12 | | A | 26 | | | | | 26 |
| | 28-13 | A | 26 | | | | | 26 |
| 28-15 | | A | 35 | | | | | 35 |
| | 28-16 | A | 20 | | | | | 20 |
| 28-17 | | R = B; M, N, P = D; A to L = A | 15 | | | | | 15 |
| 28-18 | | M = C; G, H, J, K, L = D; A, B = H; Bal. = Inst. | 12 | | | | | 12 |
| 28-19 | | H, M = B; A, B = D; Bal. = A | 10 | | | | 4 | 6 |
| 28-20 | | A | 14 | | | | 10 | 4 |

| Insert Arrangement | | Service Rating | Total Contacts | Contact Size | | | | |
|--------------------|------------|--|----------------|--------------|---|---|----|-----|
| MS Approved | Industrial | | | 0 | 4 | 8 | 12 | 16 |
| 28-21 | | A | 37 | | | | | 37 |
| 28-22 | | D | 6 | | 3 | | | 3 |
| 32-1 | | A = E; Bal. = D | 5 | 2 | | | 3 | |
| 32-2 | | E | 5 | | 3 | | | 2 |
| 32-3 | | D | 9 | 1 | 2 | | 2 | 4 |
| | 32-4 | F, J, K, N = A; Bal. = D | 14 | | | | 2 | 12 |
| | 32-5 | D | 2 | 2 | | | | |
| 32-6 | | A | 23 | | 2 | 3 | 2 | 16 |
| 32-7 | | A, B, h, j = Inst.; Bal. = A | 35 | | | | 7 | 28 |
| | 32-8 | A | 30 | | | | 6 | 24 |
| 32-9 | | D | 14 | | 2 | | | 12 |
| | 32-10 | A, F = E; G = B; B, E = D; C, D = A | 7 | | 2 | 2 | | 3 |
| | 32-12 | C, D, E, F, G = A; Bal. = D | 15 | | | | 5 | 10 |
| 32-13 | | D | 23 | | | | 5 | 18 |
| 32-15 | | D | 8 | 2 | | | 6 | |
| | 32-16 | A | 23 | | 2 | 3 | 2 | 16 |
| 32-17 | | D | 4 | | 4 | | | |
| 32-73 | | A | 46 | | | | | 46 |
| | 36-1 | D | 22 | | | | 4 | 18 |
| 36-3 | | D | 6 | 3 | | | 3 | |
| | 36-4 | A = D; B, C = A | 3 | 3 | | | | |
| 36-5 | | A | 4 | 4 | | | | |
| 36-6 | | A | 6 | 2 | 4 | | | |
| 36-7 | | A | 47 | | | | 7 | 40 |
| 36-8 | | A | 47 | | | | 1 | 46 |
| 36-9 | | A | 31 | | 1 | 2 | 14 | 14 |
| 36-10 | | A | 48 | | | | | 48 |
| | 36-11 | A | 48 | | | | | 48 |
| | 36-12 | A | 48 | | | | | 48 |
| | 36-13 | N, P, Q = E; Bal. = A | 17 | | | | 2 | 15 |
| | 36-14 | D | 16 | | | 5 | 5 | 6 |
| 36-15 | | M = D; Bal. = A | 35 | | | | | 35 |
| | 36-16 | A | 47 | | | | 7 | 40 |
| | 36-17 | A | 47 | | | | 7 | 40 |
| | 36-18 | A | 31 | | 1 | 2 | 14 | 14 |
| | 36-20 | A | 34 | | | 2 | 2 | 30 |
| 36-52 | | A | 52 | | | | | 52 |
| 40-1 | | D | 30 | | | | 6 | 24 |
| 40-9 | | A | 47 | | | 1 | 22 | 24 |
| 40-56 | | A | 85 | | | | | 85 |
| 44-52 | | A | 104 | | | | | 104 |

QWLD

special insert arrangements

| Insert Arrangement | Service Rating | Total Con-acts | Contact Size | | | | | | | | | | | | | | | | | | | |
|--------------------|----------------|----------------|--------------|---|----|----|----|--------|---|---|----|---|---|---|--|--|--|--|--|--|--|----|
| | | | 0 | 4 | 8 | 12 | 16 | Coax** | | | | | | | | | | | | | | |
| | | | | | | | | 0 | 4 | 8 | 12 | | | | | | | | | | | |
| 16-59 | A | 4 | | | | 4 | | | | | | | | | | | | | | | | |
| 20-51 | A | 3 | | | 3 | | | | | | | | | | | | | | | | | |
| 20-57 | A | 7 | | | | 7* | | | | | | | | | | | | | | | | |
| 20-58 | A | 10 | | | | 5 | 5 | | | | | | | | | | | | | | | |
| 20-59 | A | 3 | | | 3* | | | | | | | | | | | | | | | | | |
| 20-66 | A | 6 | | | | 5* | 1 | | | | | | | | | | | | | | | |
| 20-79 | A/D | 8 | | | | 1 | 7 | | | | | | | | | | | | | | | |
| 22-63 | A | 12 | | | | 4 | 8 | | | | | | | | | | | | | | | |
| 22-65 | A/D | 8 | | | | 8* | | | | | | | | | | | | | | | | |
| 22-70 | A | 13 | | | | 8 | 5 | | | | | | | | | | | | | | | |
| 22-80 | A | 3 | | | 3* | | | | | | | | | | | | | | | | | |
| 24-51 | A | 5 | | | 5 | | | | | | | | | | | | | | | | | |
| 24-52 | Hi Volt. | 1 | | | | 1 | | | | | | | | | | | | | | | | |
| 24-53 | A | 5 | | | 5 | | | | | | | | | | | | | | | | | |
| 24-58 | A | 13 | | | 3 | 3 | 7 | | | | | | | | | | | | | | | |
| 24-59 | A | 14 | | | | 7 | 7 | | | | | | | | | | | | | | | |
| 24-60 | A | 7 | | | 7* | | | | | | | | | | | | | | | | | |
| 24-65 | A | 15 | | | | 11 | 4 | | | | | | | | | | | | | | | |
| 24-66 | D | 7 | | | | 7 | | | | | | | | | | | | | | | | |
| 24-67 | Inst. | 19 | | | | 19 | | | | | | | | | | | | | | | | |
| 24-71 | A | 7 | | | 7* | | | | | | | | | | | | | | | | | |
| 24-75 | A | 7 | | | 7* | | | | | | | | | | | | | | | | | |
| 24-79 | A | 5 | | | 5 | | | | | | | | | | | | | | | | | |
| 24-80 | Inst. | 23 | | | | | 23 | | | | | | | | | | | | | | | |
| 24-84 | A | 19 | | | | 1 | | | | | | | | | | | | | | | | 18 |
| 28-51 | A | 12 | | | | 12 | | | | | | | | | | | | | | | | |
| 28-59 | A | 17 | | | | 7 | 10 | | | | | | | | | | | | | | | |
| 28-66 | A | 16 | | | 2 | 14 | | | | | | | | | | | | | | | | |
| 28-72 | Coax | 3 | | | | | | | | | | 3 | | | | | | | | | | |
| 28-74 | A | 16 | | | 7* | | 9 | | | | | | | | | | | | | | | |
| 28-75 | A | 16 | | | 7* | | 9 | | | | | | | | | | | | | | | |
| 28-79 | A | 16 | | | 7 | | 9 | | | | | | | | | | | | | | | |
| 28-82 | D | 6 | | | 2 | 4 | | | | | | | | | | | | | | | | |
| 28-84 | A | 9 | | | 9 | | | | | | | | | | | | | | | | | |
| 32-52 | D | 8 | 2 | | | 6 | | | | | | | | | | | | | | | | |
| 32-53 | Inst./E | 42 | | | | 5 | 37 | | | | | | | | | | | | | | | |
| 32-56 | A | 30 | | | | 6* | 24 | | | | | | | | | | | | | | | |
| 32-57 | Coax | 8 | | | | 6 | | 2 | | | | | | | | | | | | | | |
| 32-58 | Coax | 4 | | | | | | | | | | 4 | | | | | | | | | | |
| 32-60 | A | 23 | | | | | 15 | | | | | | 8 | | | | | | | | | |
| 32-62 | Coax | 23 | | 2 | 1 | 2 | 16 | | | | | | | 2 | | | | | | | | |
| 32-64 | Inst. | 54 | | | | | 54 | | | | | | | | | | | | | | | |
| 32-68 | A | 16 | | | | | 12 | | 4 | | | | | | | | | | | | | |
| 32-75 | Coax | 9 | | | | 2 | | | | | | 7 | | | | | | | | | | |
| 32-76 | A | 19 | | | | 19 | | | | | | | | | | | | | | | | |
| 32-79 | D | 5 | | 4 | 1 | | | | | | | | | | | | | | | | | |

| Insert Arrangement | Service Rating | Total Con-acts | Contact Size | | | | | | | | | | | | | | | | | | | |
|--------------------|----------------|----------------|--------------|---|----|----|-----|--------|----|---|----|--|-----|---|--|--|--|--|---|--|----|--|
| | | | 0 | 4 | 8 | 12 | 16 | Coax** | | | | | | | | | | | | | | |
| | | | | | | | | 0 | 4 | 8 | 12 | | | | | | | | | | | |
| 36-51 | D | 4 | 2 | 2 | | | | | | | | | | | | | | | | | | |
| 36-54 | A | 39 | | | 8 | | 31 | | | | | | | | | | | | | | | |
| 36-55 | A | 39 | | | 8* | | 31 | | | | | | | | | | | | | | | |
| 36-59 | A | 53 | | | | | 3* | 50 | | | | | | | | | | | | | | |
| 36-60 | A | 47 | | | | | 7* | 40 | | | | | | | | | | | | | | |
| 36-64 | Coax | 4 | | | | | | | | | | | 4 | | | | | | | | | |
| 36-65 | Coax | 4 | | | | | | | | | | | 4 | | | | | | | | | |
| 36-71 | A | 53 | | | | | 3 | 50 | | | | | | | | | | | | | | |
| 36-73 | Coax | 7 | | | | | | | | | | | | | | | | | 7 | | | |
| 36-74 | A | 44 | | | | | | | | | | | 43 | | | | | | | | 1 | |
| 36-75 | A | 48 | | | | | | | | | | | 48* | | | | | | | | | |
| 36-76 | A | 47 | | | | | | | | | | | 47 | | | | | | | | | |
| 36-77 | D | 7 | | 7 | | | | | | | | | | | | | | | | | | |
| 36-78 | A | 14 | | | | 12 | | 2 | | | | | | | | | | | | | | |
| 36-79 | A | 20 | | | | | 20 | | | | | | | | | | | | | | | |
| 36-80 | A | 20 | | | | | 20* | | | | | | | | | | | | | | | |
| 36-83 | Coax | 7 | | | | | | | | | | | | | | | | | 7 | | | |
| 36-85 | A/D | 35 | | | | | | | | | | | 35* | | | | | | | | | |
| 40-53 | A | 60 | | | | | | | | | | | 60 | | | | | | | | | |
| 40-57 | E | 4 | 4 | | | | | | | | | | | | | | | | | | | |
| 40-61 | A | 59 | | | | 1 | 3 | 55 | | | | | | | | | | | | | | |
| 40-62 | A | 60 | | | | | | 60 | | | | | | | | | | | | | | |
| 40-63 | A | 61 | | | | | | 61* | | | | | | | | | | | | | | |
| 40-64 | Coax | 36 | | | | | 3 | 20 | | | | | | | | | | | | | 13 | |
| 40-66 | Coax | 4 | | | | | | | | | | | 4 | | | | | | | | | |
| 40-67 | A | 11 | | | | | | 1 | | | | | 10 | | | | | | | | | |
| 40-68 | A | 21 | | | | 21 | | | | | | | | | | | | | | | | |
| 40-70 | A | 61 | | | | | | 61 | | | | | | | | | | | | | | |
| 40-72 | A | 11 | | | | | | 1 | | | | | 10 | | | | | | | | | |
| 40-73 | A | 61 | | | | | | 61 | | | | | | | | | | | | | | |
| 40-74 | A | 6 | | | | | | 1 | | | | | 4 | 1 | | | | | | | | |
| 40-75 | E | 5 | 4 | | | | | 1 | | | | | | | | | | | | | | |
| 40-80 | A | 11 | | | | 10 | | | | | | | 1 | | | | | | | | | |
| 40-81 | A | 62 | | | | | | | | | | | 62* | | | | | | | | | |
| 40-82 | A | 62 | | | | | | | | | | | 62 | | | | | | | | | |
| 40-85 | A | 60 | | | | | | | | | | | 60* | | | | | | | | | |
| 40-86 | E | 4 | | | | | | | | | | | 4 | | | | | | | | | |
| 40-87 | D | 7 | | | | 7 | | | | | | | | | | | | | | | | |
| 44-53 | A | 36 | | | | | | | | | | | 18 | | | | | | | | 18 | |
| 48-51† | A | 56 | | | | 10 | | 42 | 4 | | | | | | | | | | | | | |
| 48-52† | A | 61 | | | | | | 56 | 5 | | | | | | | | | | | | | |
| 48-53† | D | 37 | | | | | | | 37 | | | | | | | | | | | | | |
| 48-54† | A | 56 | | | | 10 | | 42 | 4 | | | | | | | | | | | | | |
| 48-55† | A | 78 | | | | 6 | 2 | 2 | 68 | | | | | | | | | | | | | |
| 48-57† | A | 56 | 4 | | | 10 | | 42 | | | | | | | | | | | | | | |
| 48-60† | A | 56 | | | | 10 | | 42 | 4 | | | | | | | | | | | | | |

* Crimp contacts accommodate wire the same size as the contact as well as wire of the next smaller, even size. Arrangements identified with an asterisk (*) are exceptions. See insert arrangement drawings on pages 39-47 for application wire size.

** Coaxial cable data can be found on insert arrangement drawings, pages 39-47. For further information on coaxial contacts and cable see catalog 12-130.

† Consult Sidney, NY for availability.

MIL-C-22992, QWLD

alternate insert rotations

To avoid cross-plugging problems in applications requiring the use of more than one connector of the same size and arrangement, alternate insert rotations are available as indicated in the accompanying chart.

As shown in the diagram below, the front face of the pin insert is rotated within the shell in a clockwise direction from the normal shell key. The socket insert would be rotated counterclockwise the same number of degrees in respect to the normal shell key.

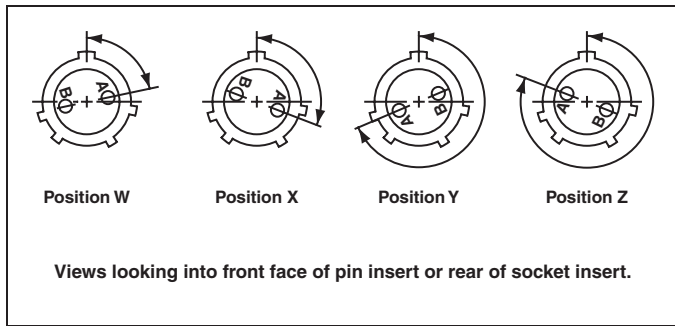

The following insert arrangements have the same alternate insert rotations for W, X, Y and Z which are:

| Degrees | | | |
|---------|-----|-----|-----|
| W | X | Y | Z |
| 80 | 110 | 250 | 280 |

| | | | | | | |
|-------|-------|-------|-------|-------|-------|-------|
| 16-7 | 20-14 | 22-16 | 24-3 | 24-21 | 28-16 | 32-9 |
| 18-5 | 20-16 | 22-17 | 24-4 | 24-28 | 28-17 | 32-10 |
| 18-9 | 20-20 | 22-18 | 24-5 | 28-1 | 28-19 | 32-12 |
| 18-13 | 20-22 | 22-19 | 24-6 | 28-4 | 28-20 | 32-13 |
| 18-14 | 22-3 | 22-21 | 24-7 | 28-8 | 28-21 | 36-1 |
| 20-7 | 22-6 | 22-24 | 24-12 | 28-9 | 32-1 | 36-7 |
| 20-8 | 22-12 | 22-25 | 24-16 | 28-10 | 32-3 | 36-8 |
| 20-9 | 22-14 | 22-33 | 24-17 | 28-11 | 32-4 | 36-13 |
| 20-12 | 22-15 | 22-34 | 24-20 | 28-15 | 32-6 | |

| Insert Arrangement | Degrees | | | |
|--------------------|---------|-----|-----|-----|
| | W | X | Y | Z |
| 16-9 | 35 | 110 | 250 | 325 |
| 16-10 | 90 | 180 | 270 | - |
| 16-11 | 35 | 110 | 250 | 325 |
| 16-13 | 35 | 110 | 250 | 325 |
| 16-61 | 80 | - | - | 280 |
| 18-1 | 70 | 145 | 215 | 290 |
| 18-3 | 35 | 110 | 250 | 325 |
| 18-4 | 35 | 110 | 250 | 325 |
| 18-8 | 70 | - | - | 290 |
| 18-10 | - | 120 | 240 | - |
| 18-11 | - | 170 | 265 | - |
| 18-12 | 80 | - | - | 280 |
| 18-15 | - | 120 | 240 | - |
| 18-19 | - | 120 | 240 | - |
| 18-20 | 90 | 180 | 270 | - |
| 18-22 | 70 | 145 | 215 | 290 |
| 18-29 | 90 | 180 | 270 | - |
| 20-3 | 70 | 145 | 215 | 290 |
| 20-4 | 45 | 110 | 250 | - |
| 20-5 | 35 | 110 | 250 | 325 |
| 20-6 | 70 | 145 | 215 | 290 |
| 20-15 | 80 | - | - | 280 |
| 20-17 | 90 | 180 | 270 | - |
| 20-18 | 35 | 110 | 250 | 325 |
| 20-19 | 90 | 180 | 270 | - |
| 20-21 | 35 | 110 | 250 | 325 |
| 20-23 | 35 | 110 | 250 | 325 |

| Insert Arrangement | Degrees | | | |
|--------------------|---------|-----|-----|-----|
| | W | X | Y | Z |
| 20-24 | 35 | 110 | 250 | 325 |
| 20-27 | 35 | 110 | 250 | 325 |
| 20-29 | 80 | - | - | 280 |
| 22-1 | 35 | 110 | 250 | 325 |
| 22-2 | 70 | 145 | 215 | 290 |
| 22-4 | 35 | 110 | 250 | 325 |
| 22-5 | 35 | 110 | 250 | 325 |
| 22-8 | 35 | 110 | 250 | 325 |
| 22-9 | 70 | 145 | 215 | 290 |
| 22-10 | 35 | 110 | 250 | 325 |
| 22-11 | 35 | 110 | 250 | 325 |
| 22-13 | 35 | 110 | 250 | 325 |
| 22-20 | 35 | 110 | 250 | 325 |
| 22-22 | - | 110 | 250 | - |
| 22-23 | 35 | - | 250 | - |
| 22-27 | 80 | - | 250 | 280 |
| 22-28 | 80 | - | - | 280 |
| 22-36 | 90 | - | 270 | - |
| 24-2 | 80 | - | - | 280 |
| 24-9 | 35 | 110 | 250 | 325 |
| 24-10 | 80 | - | - | 280 |
| 24-11 | 35 | 110 | 250 | 325 |
| 24-22 | 45 | 110 | 250 | - |
| 24-27 | 80 | - | - | 280 |
| 28-2 | 35 | 110 | 250 | 325 |
| 28-3 | 70 | 145 | 215 | 290 |
| 28-5 | 35 | 110 | 250 | 325 |

| Insert Arrangement | Degrees | | | |
|--------------------|---------|-----|-----|-----|
| | W | X | Y | Z |
| 28-6 | 70 | 145 | 215 | 290 |
| 28-7 | 35 | 110 | 250 | 325 |
| 28-12 | 90 | 180 | 270 | - |
| 28-18 | 70 | 145 | 215 | 290 |
| 28-22 | 70 | 145 | 215 | 290 |
| 32-2 | 70 | 145 | 215 | 290 |
| 32-5 | 35 | 110 | 250 | 325 |
| 32-7 | 80 | 125 | 235 | 280 |
| 32-8 | 80 | 125 | 235 | 280 |
| 32-15 | 35 | 110 | 250 | 280 |
| 32-17 | 45 | 110 | 250 | - |
| 32-73 | 36 | - | - | - |
| 36-3 | 70 | 145 | 215 | 290 |
| 36-4 | 70 | 145 | 215 | 290 |
| 36-5 | - | 120 | 240 | - |
| 36-6 | 35 | 110 | 250 | 325 |
| 36-9 | 80 | 125 | 235 | 280 |
| 36-10 | 80 | 125 | 235 | 280 |
| 36-14 | 90 | 180 | 270 | - |
| 36-15 | 60 | 125 | 245 | 305 |
| 36-52 | 72 | 144 | 216 | 288 |
| 40-1 | 65 | 130 | 235 | 300 |
| 40-9 | 65 | 125 | 225 | 310 |
| 40-56 | 72 | 144 | 216 | 288 |
| 44-52 | 72 | 135 | 225 | 288 |
| | | | | |
| | | | | |

MIL-C-22992, QWLD

contact arrangements

front face of pin insert or rear of socket insert illustrated

| | | | | | | |
|---------------------------|------|-------|-------|------|-------|------|
| | | | | | | |
| Insert Arrangement | 12-5 | 12-48 | 12-49 | 14-3 | 14-53 | 16-2 |
| Service Rating | D | A | A | A | Inst. | E |
| Number of Contacts | 1 | 3 | 2 | 1 | 6 | 1 |
| Contact Size | 12 | 16 | 16 | 8 | 16 | 12 |

| | | | | | | |
|---------------------------|------|-------|-------|-------|-------|-------|
| | | | | | | |
| Insert Arrangement | 16-7 | 16-9 | 16-10 | 16-11 | 16-12 | 16-13 |
| Service Rating | A | A | A | A | A | A |
| Number of Contacts | 1 2 | 2 2 | 3 | 2 | 1 | 2* |
| Contact Size | 8 16 | 12 16 | 12 | 12 | 4 | 12 |

| | | | | | | |
|---------------------------|-------|------------------------------|------|------|-------|------|
| | | | | | | |
| Insert Arrangement | 16-61 | 18-1 | 18-3 | 18-4 | 18-5 | 18-6 |
| Service Rating | A | B, C, F, G = A; Bal. = Inst. | D | D | D | D |
| Number of Contacts | 7 | 10 | 2 | 4 | 2 1 | 1 |
| Contact Size | 16 | 16 | 12 | 16 | 12 16 | 4 |

| | | | | | | |
|---------------------------|------|-------|-------|-------|-------|-------|
| | | | | | | |
| Insert Arrangement | 18-7 | 18-8 | 18-9 | 18-10 | 18-11 | 18-12 |
| Service Rating | B | A | Inst. | A | A | A |
| Number of Contacts | 1 | 1 7 | 2 5 | 4 | 5 | 6 |
| Contact Size | 8 | 12 16 | 12 16 | 12 | 12 | 16 |

*A = Iron; B = Constantan

CONTACT LEGEND

| | | | | | |
|----|----|---|---|---|--|
| | | | | | |
| 16 | 12 | 8 | 4 | 0 | |

MIL-C-22992, QWLD

contact arrangements

front face of pin insert or rear of socket insert illustrated

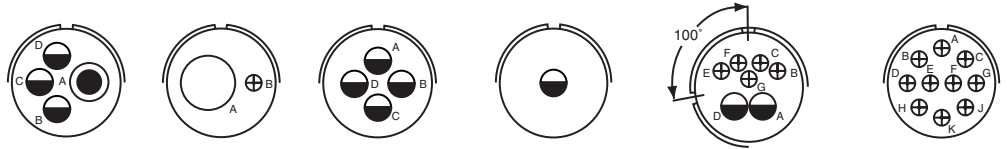

100° Rotation
of 18-9

| | | | | | | |
|--------------------|-------|-------|-------|-------|-------|-------|
| Insert Arrangement | 18-13 | 18-14 | 18-15 | 18-16 | 18-17 | 18-19 |
| Service Rating | A | A | A | C | Inst. | A |
| Number of Contacts | 1 3 | 1 1 | 4** | 1 | 2 5 | 10 |
| Contact Size | 8 12 | 4 16 | 12 | 12 | 12 16 | 16 |

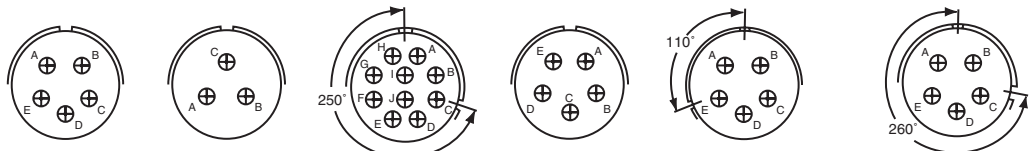

250° Rotation
of 18-1

110° Rotation
of 18-20

260° Rotation
of 18-20

| | | | | | | |
|--------------------|-------|-------|------------------------------|-------|-------|-------|
| Insert Arrangement | 18-20 | 18-22 | 18-24 | 18-29 | 18-30 | 18-31 |
| Service Rating | A | D | B, C, F, G = A, Bal. = Inst. | A | A | A |
| Number of Contacts | 5 | 3 | 10 | 5 | 5 | 5 |
| Contact Size | 16 | 16 | 16 | 16 | 16 | 16 |

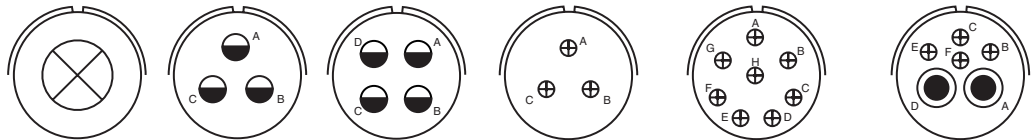

| | | | | | | |
|--------------------|------|------|------|------|--------------------------------|-------|
| Insert Arrangement | 20-2 | 20-3 | 20-4 | 20-6 | 20-7 | 20-8 |
| Service Rating | D | D | D | D | A, B, H, G = D; C, D, E, F = A | Inst. |
| Number of Contacts | 1 | 3 | 4 | 3 | 8 | 2 4 |
| Contact Size | 0 | 12 | 12 | 16 | 16 | 8 16 |

**A, C = Iron; B, D = Constantan

CONTACT LEGEND

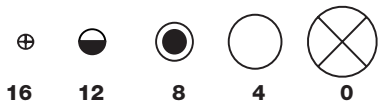

MIL-C-22992, QWLD

contact arrangements

front face of pin insert or rear of socket insert illustrated

| | | | | | | |
|---------------------------|-----------------|-------|-------|-------|-------|-------|
| | | | | | | |
| Insert Arrangement | 20-9 | 20-11 | 20-12 | 20-14 | 20-15 | 20-16 |
| Service Rating | H = D; Bal. = A | Inst. | A | A | A | A |
| Number of Contacts | 1 7 | 13 | 1 1 | 2 3 | 7 | 2 7 |
| Contact Size | 12 16 | 16 | 4 16 | 8 12 | 12 | 12 16 |

| | | | | | | |
|---------------------------|-------|-------|-------|-------|-------|-------|
| | | | | | | |
| Insert Arrangement | 20-17 | 20-18 | 20-19 | 20-20 | 20-21 | 20-22 |
| Service Rating | A | A | A | A | A | A |
| Number of Contacts | 5 1 | 3 6 | 3 | 1 3 | 1 8 | 3 3 |
| Contact Size | 12 16 | 12 16 | 8 | 4 12 | 12 16 | 8 16 |

| | | | | | | |
|---------------------------|-------|-------|-------|-------|-------|-------|
| | | | | | | |
| Insert Arrangement | 20-23 | 20-24 | 20-25 | 20-27 | 20-29 | 20-30 |
| Service Rating | A | A | Inst. | A | A | Inst. |
| Number of Contacts | 2 | 2 2 | 13 | 14 | 17 | 13 |
| Contact Size | 8 | 8 16 | 16 | 16 | 16 | 16 |



MIL-C-22992, QWLD

contact arrangements

front face of pin insert or rear of socket insert illustrated

| | | | | | |
|----------------------------|--------------|-------------|-------------|-------------|--------------|
| | | | | | |
| Insert Arrangements | 20-33 | 22-1 | 22-2 | 22-4 | 22-5 |
| Service Rating | A | D | D | A | D |
| Number of Contacts | 11 | 2 | 3 | 2 2 | 2 4 |
| Contact Size | 16 | 8 | 8 | 8 12 | 12 16 |

| | | | | | |
|---------------------------|-------------|-------------|-------------|-------------|--------------|
| | | | | | |
| Insert Arrangement | 22-6 | 22-7 | 22-8 | 22-9 | 22-10 |
| Service Rating | D | E | E | E | E |
| Number of Contacts | 2 1 | 1 | 2 | 3 | 4 |
| Contact Size | 8 16 | 0 | 12 | 12 | 16 |

| | | | | | |
|---------------------------|--------------|--------------|------------------------------|--------------|---------------------------------|
| | | | | | |
| Insert Arrangement | 22-11 | 22-12 | 22-13 | 22-14 | 22-15 |
| Service Rating | B | D | E = D; A, B, C, D = A | A | D = E; A, B, C, E, F = A |
| Number of Contacts | 2 | 2 3 | 4 1 | 19 | 5 1 |
| Contact Size | 16 | 8 16 | 12 16 | 16 | 12 16 |

| | | | | | |
|-----------------------|-----------|-----------|----------|----------|----------|
| | | | | | |
| CONTACT LEGEND | 16 | 12 | 8 | 4 | 0 |

MIL-C-22992, QWLD contact arrangements

front face of pin insert or rear of socket insert illustrated

| | | | | | |
|---------------------------|--------------|------------------------|---------------------------------------|--------------|--------------|
| | | | | | |
| Insert Arrangement | 22-16 | 22-17 | 22-18 | 22-19 | 22-20 |
| Service Rating | A | A = D; Bal. = A | A, B, F, G, H = D; C, D, E = A | A | A |
| Number of Contacts | 3 6 | 1 8 | 8 | 14 | 9 |
| Contact Size | 12 16 | 12 16 | 16 | 16 | 16 |

| | | | | | |
|---------------------------|--------------|--------------|------------------------|---------------------------------|------------------------|
| | | | | | |
| Insert Arrangement | 22-21 | 22-22 | 22-23 | 22-24 | 22-27 |
| Service Rating | A | A | H = D; Bal. = A | C, D, E = D; A, B, F = A | J = D; Bal. = A |
| Number of Contacts | 1 2 | 4 | 8 | 2 4 | 1 8 |
| Contact Size | 0 16 | 8 | 12 | 12 16 | 8 16 |

| | | | | | |
|---------------------------|--------------|------------------------------------|--------------|------------------------|-------------|
| | | | | | |
| Insert Arrangement | 22-28 | 22-33 | 22-34 | 22-36 | 24-2 |
| Service Rating | A | A, B, C, D = D; E, F, G = A | D | H = D; Bal. = A | D |
| Number of Contacts | 7 | 7 | 3 2 | 8 | 7 |
| Contact Size | 12 | 16 | 12 16 | 12 | 12 |



MIL-C-22992, QWLD

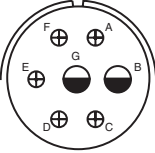
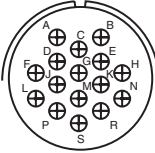
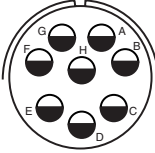
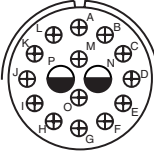
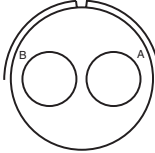

contact arrangements

front face of pin insert or rear of socket insert illustrated

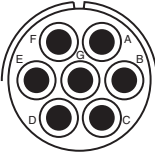
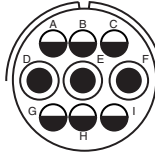
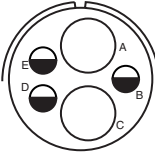
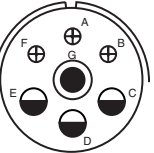
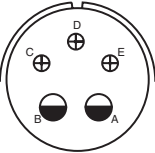
| | | | | | |
|---------------------------|---|---|--|---|---|
| |  |  |  |  |  |
| Insert Arrangement | 24-3 | 24-5 | 24-6 | 24-7 | 24-9 |
| Service Rating | D | A | A, G, H = D; Bal. = A | A | A |
| Number of Contacts | 2 5 | 16 | 8 | 2 14 | 2 |
| Contact Size | 12 16 | 16 | 12 | 12 16 | 4 |

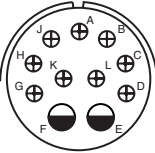
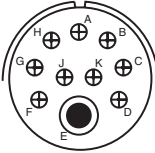
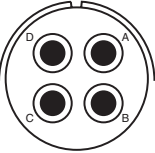
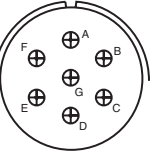
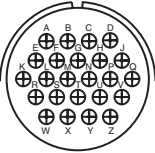
| | | | | | |
|---------------------------|--|--|---|--|--|
| |  |  |  |  |  |
| Insert Arrangement | 24-10 | 24-11 | 24-12 | 24-16 | 24-17 |
| Service Rating | A | A | A | A, B, F, G = D; C, D, E = A | D |
| Number of Contacts | 7 | 3 6 | 2 3 | 1 3 3 | 2 3 |
| Contact Size | 8 | 8 12 | 4 12 | 8 12 16 | 12 16 |

| | | | | | |
|---------------------------|---|---|--|---|---|
| |  |  |  |  |  |
| Insert Arrangement | 24-20 | 24-21 | 24-22 | 24-27 | 24-28 |
| Service Rating | D | D | D | E | Inst. |
| Number of Contacts | 2 9 | 1 9 | 4 | 7 | 24 |
| Contact Size | 12 16 | 8 16 | 8 | 16 | 16 |

| | | | | | |
|-----------------------|---|---|---|---|---|
| |  |  |  |  |  |
| CONTACT LEGEND | 16 | 12 | 8 | 4 | 0 |

MIL-C-22992, QWLD contact arrangements

front face of pin insert or rear of socket insert illustrated

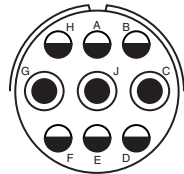

28-1
A, J, E = D; Bal. = A
3 6
8 12

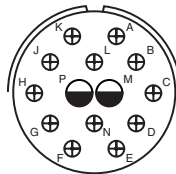

28-2
D
2 12
12 16

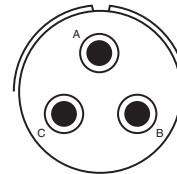

28-3
E
3
8

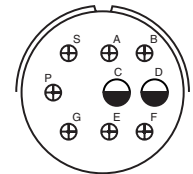

28-4
G, P, S = E; Bal. = D
2 7
12 16

Insert Arrangement
Service Rating
Number of Contacts
Contact Size

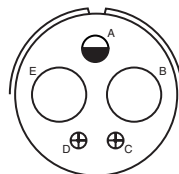

28-5
D
2 1 2
4 12 16

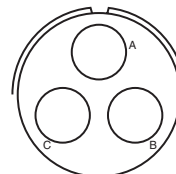

28-6
D
3
4

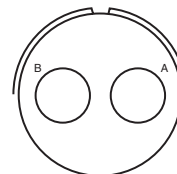

28-7
D
2
4

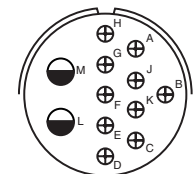

28-8
L, M = E; B = D; Bal. = A
2 10
12 16

Insert Arrangement
Service Rating
Number of Contacts
Contact Size

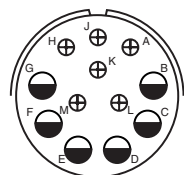

28-9
D
6 6
12 16

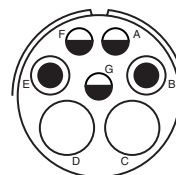

28-10
G = D; Bal. = A
2 2 3
4 8 12

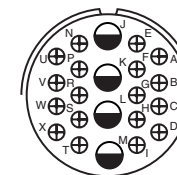

28-11
A
4 18
12 16

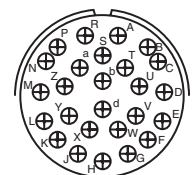

28-12
A
26
16

Insert Arrangement
Service Rating
Number of Contacts
Contact Size

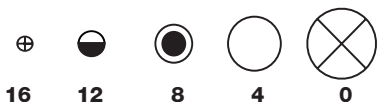

CONTACT LEGEND

16

12

8

4

0

MIL-C-22992, QWLD

contact arrangements

front face of pin insert or rear of socket insert illustrated

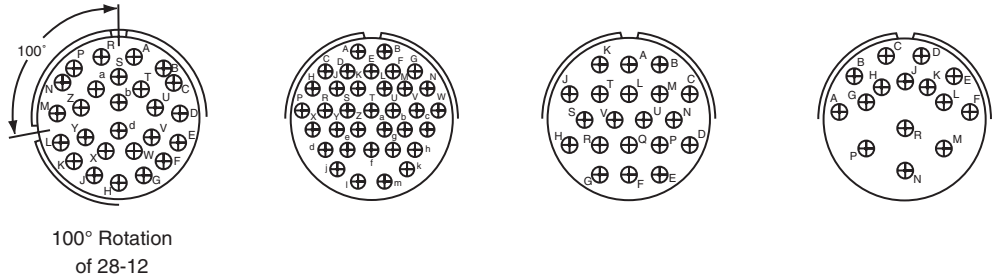

| | | | | |
|--------------------|-------|-------|-------|--------------------------------|
| Insert Arrangement | 28-13 | 28-15 | 28-16 | 28-17 |
| Service Rating | A | A | A | R = B; M, N, P = D; A to L = A |
| Number of Contacts | 26 | 35 | 20 | 15 |
| Contact Size | 16 | 16 | 16 | 16 |

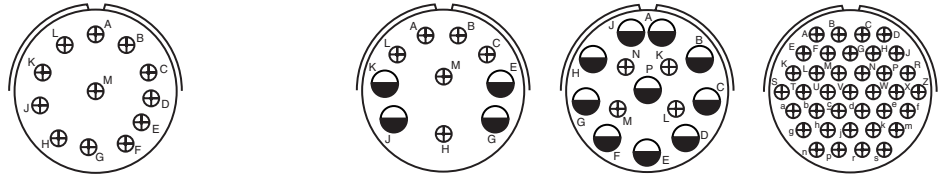

| | | | | |
|--------------------|--|--------------------------|-------|-------|
| Insert Arrangement | 28-18 | 28-19 | 28-20 | 28-21 |
| Service Rating | M = C; G, H, J, K, L = D; A, B = H; Bal. = Inst. | H, M = B; A = D; Bal = A | A | A |
| Number of Contacts | 12 | 4 6 | 10 4 | 37 |
| Contact Size | 16 | 12 16 | 12 16 | 16 |

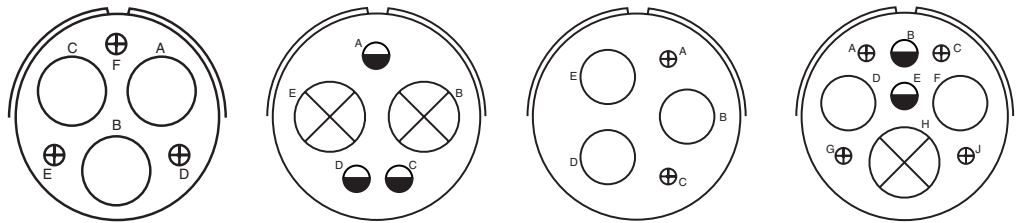

| | | | | |
|--------------------|-------|-----------------|------|-----------|
| Insert Arrangement | 28-22 | 32-1 | 32-2 | 32-3 |
| Service Rating | D | A = E; Bal. = D | E | D |
| Number of Contacts | 3 3 | 2 3 | 3 2 | 1 2 2 4 |
| Contact Size | 4 16 | 0 12 | 4 16 | 0 4 12 16 |

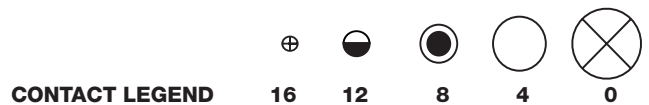

MIL-C-22992, QWLD contact arrangements

front face of pin insert or rear of socket insert illustrated

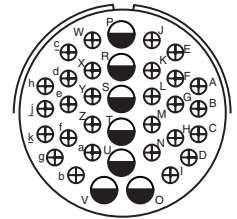
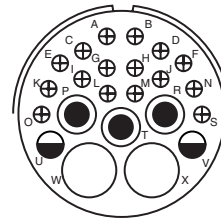
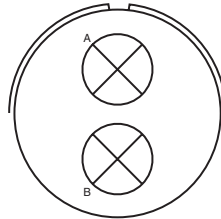
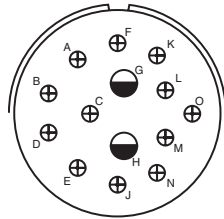

| | |
|---------------------------|---------------------------------|
| Insert Arrangement | 32-4 |
| Service Rating | F, J, K, N = A; Bal. = D |
| Number of Contacts | 2 12 |
| Contact Size | 12 16 |

| |
|-------------|
| 32-5 |
| D |
| 2 |
| 0 |

| |
|------------------|
| 32-6 |
| A |
| 2 3 2 16 |
| 4 8 12 16 |

| |
|------------------------------------|
| 32-7 |
| A, B, h, j = Inst; Bal. = A |
| 7 28 |
| 12 16 |

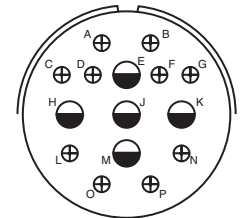
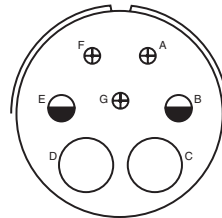
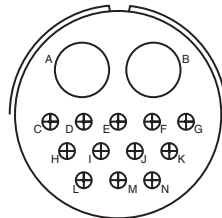
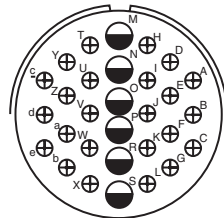

| | |
|---------------------------|--------------|
| Insert Arrangement | 32-8 |
| Service Rating | A |
| Number of Contacts | 6 24 |
| Contact Size | 12 16 |

| | |
|-------------|--|
| 32-9 | D |
| 2 12 | A, F = E, G = B; B, E = D; C, D = A |
| 4 16 | 2 2 3 |
| | 4 8 16 |

| |
|------------------------------------|
| 32-12 |
| C, D, E, F, G = A; Bal. = D |
| 5 10 |
| 12 16 |

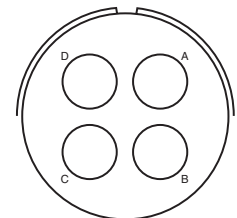
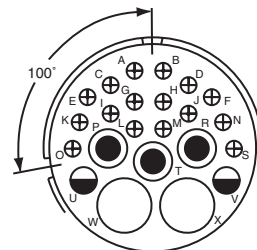
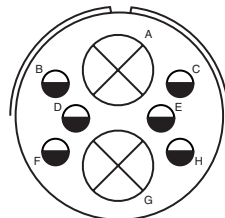
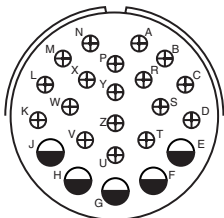

100° Rotation
of 32-6

| | |
|---------------------------|--------------|
| Insert Arrangement | 32-13 |
| Service Rating | D |
| Number of Contacts | 5 18 |
| Contact Size | 12 16 |

| |
|--------------|
| 32-15 |
| D |
| 2 6 |
| 0 12 |

| |
|------------------|
| 32-16 |
| A |
| 2 3 2 16 |
| 4 8 12 16 |

| |
|--------------|
| 32-17 |
| D |
| 4 |
| 4 |

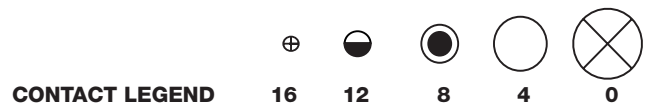

MIL-C-22992, QWLD contact arrangements

front face of pin insert or rear of socket insert illustrated

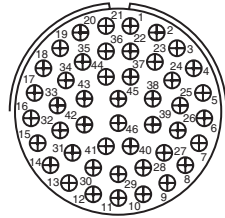

Insert Arrangement
Service Rating
Number of Contacts
Contact Size

32-73
A
46
16

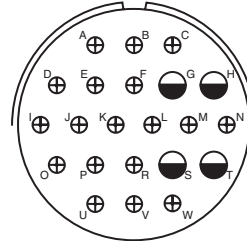

36-1
D
4 18
12 16

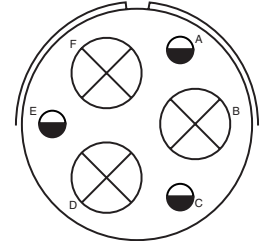

36-3
D
3 3
0 12

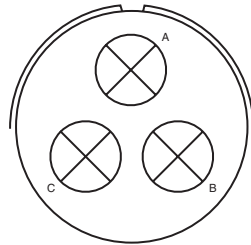

Insert Arrangement
Service Rating
Number of Contacts
Contact Size

36-4
A = D; B, C = A
3
0

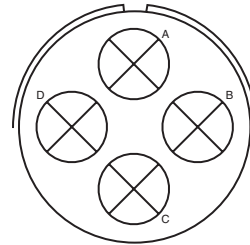

36-5
A
4
0

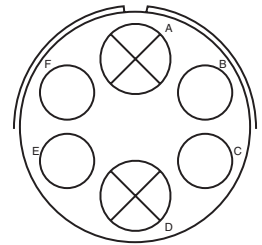

36-6
A
2 4
0 4

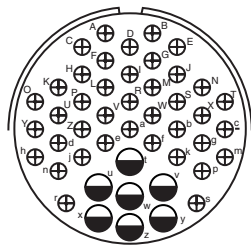

Insert Arrangement
Service Rating
Number of Contacts
Contact Size

36-7
A
7 40
12 16

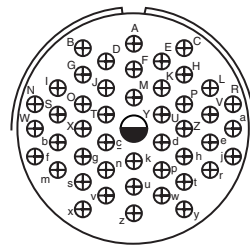

36-8
A
1 46
12 16

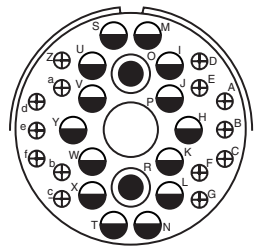

36-9
A
1 2 14 14
4 8 12 16

CONTACT LEGEND

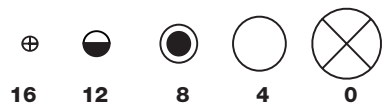

MIL-C-22992, QWLD contact arrangements

front face of pin insert or rear of socket insert illustrated

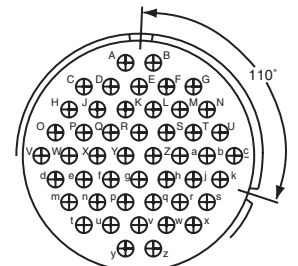
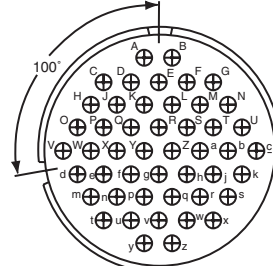
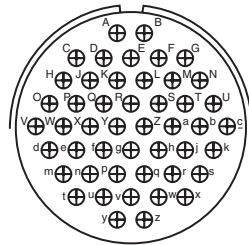

Insert Arrangement
Service Rating
Number of Contacts
Contact Size

36-10
A
48
16

100° Rotation
of 36-10

36-11
A
48
16

110° Rotation
of 36-10

36-12
A
48
16

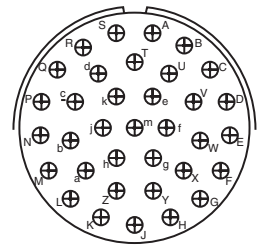
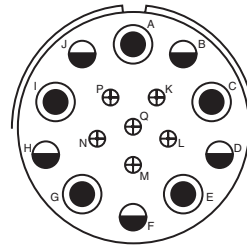
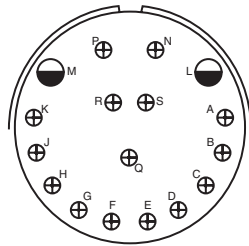

Insert Arrangement
Service Rating
Number of Contacts
Contact Size

36-13
N, P, Q = E; Bal. = A
2 15
12 16

36-14
D
5 5 6
8 12 16

36-15
M = D; Bal. = A
35
16

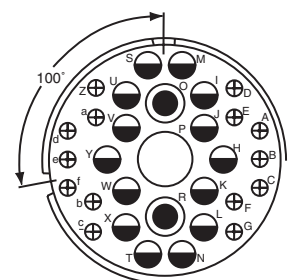
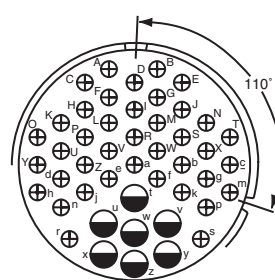
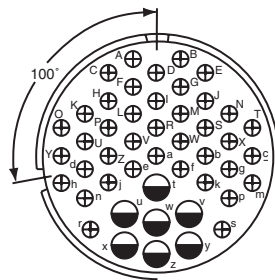

Insert Arrangements
Service Rating
Number of CContacts
Contact Size

36-16
A
7 40
12 16

110° Rotation
of 36-7

36-17
A
7 40
12 16

100° Rotation
of 36-9

36-18
A
1 2 14 14
4 8 12 16



CONTACT LEGEND

16

12

8

4

0

MIL-C-22992, QWLD contact arrangements

front face of pin insert or rear of socket insert illustrated

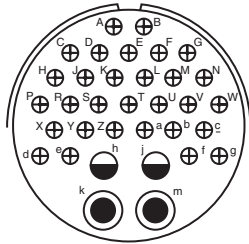

36-20
A
2 2 30
8 12 16

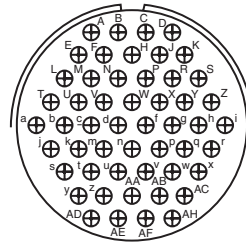

36-52
A
52
16

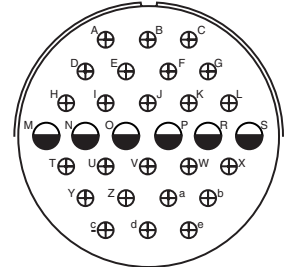

40-1
D
6 24
12 16

Insert Arrangement
Service Rating
Number of Contacts
Contact Size

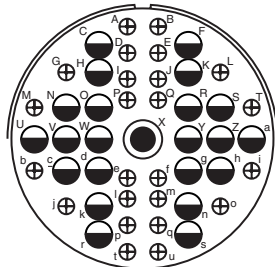

40-9
A
1 22 24
8 12 16

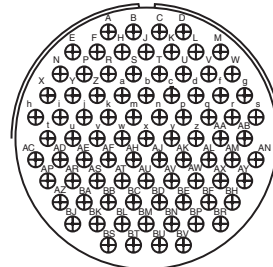

40-56
A
85
16

Insert Arrangement
Service Rating
Number of Contacts
Contact Size

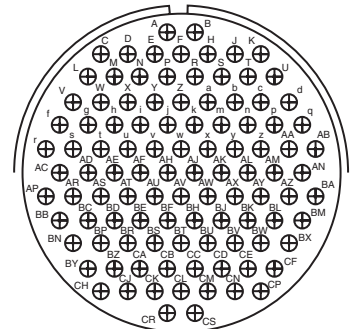

44-52
A
104
16

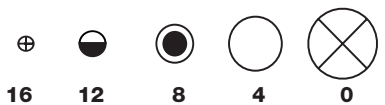

CONTACT LEGEND

16 12 8 4 0





QWLD

special arrangements

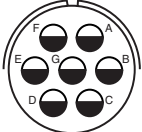
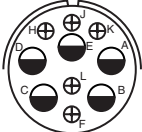

Ever expanding requirements for more complex circuits in ground equipment and elevated altitude applications has prompted Amphenol to provide inserts not covered by the MS drawings. Pictured here and on the following pages are insert layouts which have anywhere from one contact

(high tension) to the 78 contact insert in shell size 48. Many of these special inserts are also available in alternate keyway positions. Please contact Amphenol, Sidney, NY or your local Amphenol sales office for arrangements particular to your circuit application.



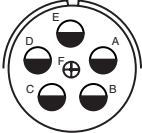
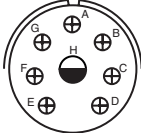
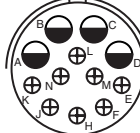
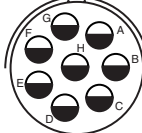

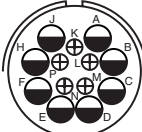
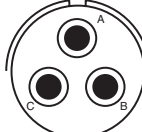
front face of pin insert or rear of socket insert illustrated

| | | | | | |
|---------------------------|---|---|--|---|---|
| |  |  |  |  |  |
| Insert Arrangement | 16-59 | 20-51 | 20-57 | 20-58 | 20-59 |
| Service Rating | A | A | A | A | A |
| Number of Contacts | 4 | 3* | 7* | 5 5 | 3* |
| Contact Size | 12 | 8 | 12 for #14 or 16 wire | 12 16 | 8 for #10 or 12 wire |

| | | | | |
|---------------------------|---|---|---|---|
| |  |  |  |  |
| Insert Arrangement | 20-66 | 20-79 | 22-63 | 22-65 |
| Service Rating | A | H = D; Bal. = A | A | H = D; Bal. = A |
| Number of Contacts | 1 5 | 7* 1* | 4 8 | 8* |
| Contact Size | 16 12 or #10 wire | 16 12 for #16 wire | 12 16 | 12 for #14 or 16 wire |

| | | | | |
|---------------------------|---|---|---|---|
| |  |  |  |  |
| Insert Arrangement | 22-70 | 22-80 | 24-51 | 24-52 |
| Service Rating | A | A | A | Hi-Volt |
| Number of Contacts | 8 5 | 3* | 5* | 1 |
| Contact Size | 12 16 | 8 for #10 or 12 wire | B, E for AN #10 or 12 wire A, C, D for AN #8 wire | 12 |

*Solderless

| | | | | | |
|-----------------------|---|---|---|---|---|
| |  |  |  |  |  |
| CONTACT LEGEND | 16 | 12 | 8 | 4 | 0 |

QWLD

special arrangements

front face of pin insert or rear of socket insert illustrated

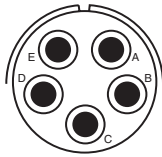

24-53
A
5*
8

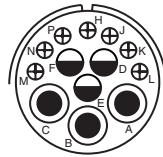

24-58
A
3 3 7
8 12 16

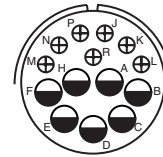

24-59
A
7 7
12 16

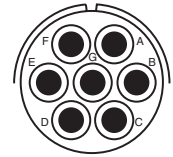

24-60
A
7*
8 for #10 or 12 wire

Insert Arrangement
Service Rating
Number of Contacts
Contact Size

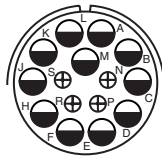

24-65
A
11 4
12 16

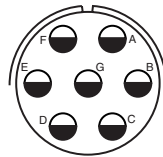

24-66
D
7
12

Insert Arrangement
Service Rating
Number of Contacts
Contact Size

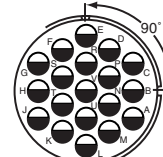

24-67
Inst.
19
12

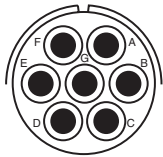

24-71
A
2* 5*
8 8 for #10 or 12 wire

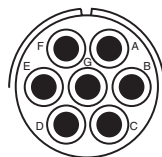

24-75
A
5 2
8 8 for #16 wire

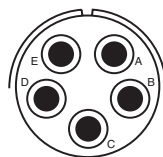

24-79
A
5
8

Insert Arrangement
Service Rating
Number of Contacts
Contact Size

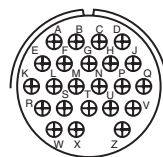

24-80
Inst.
23
16

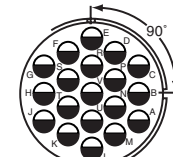

24-84
A
1 18
12 12 (Coax) RG-188/U
or RG-174/U



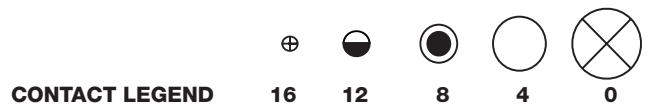

*Solderless



QWLD

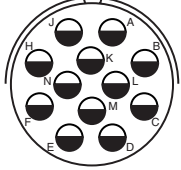
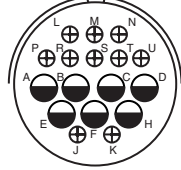
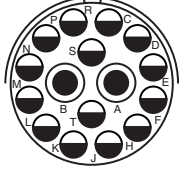
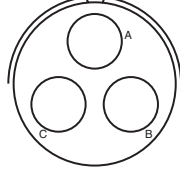

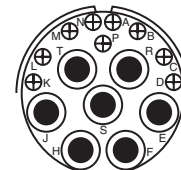
special arrangements

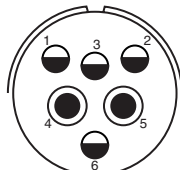
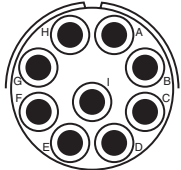
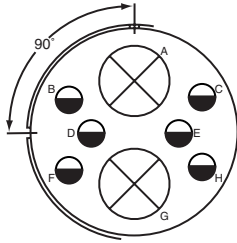
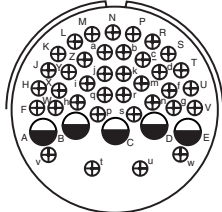
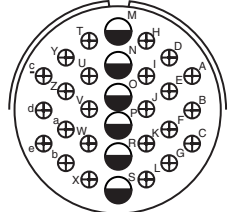
front face of pin insert or rear of socket insert illustrated

| | | | | |
|---------------------------|---|---|---|---|
| |  |  |  |  |
| Insert Arrangement | 28-51 | 28-59 | 28-66 | 28-72 |
| Service Rating | A | A | A | - |
| Number of Contacts | 12 | 7 10 | 2 14 | 3 |
| Contact Size | 12 | 12 16 | 8 12 | 4 (Coax) RG-59A/U or RG-62A/U |
| |  |  |  |  |
| Insert Arrangement | 28-74 | 28-75 | 28-79 | 28-82 |
| Service Rating | A | A | A | D |
| Number of Contacts | 9* 4* 3* | 9* 7* | 7 9 | 2 4 |
| Contact Size | 16 8 8 for #10 wire (S, T, R) | 16 8 for #10 wire | 8 16 | 8 12 |
| |  |  |  |  |
| Insert Arrangement | 28-84 | 32-52 | 32-53 | 32-56 |
| Service Rating | A | D | t, u = E; Bal. = Inst. | A |
| Number of Contacts | 9 | 6 2 | 5 37 | 24 6 |
| Contact Size | 8 | 12 0 | 12 16 | 16 12 for #10 wire |

90° CW Rotation
of 32-15

*Solderless

| CONTACT LEGEND |  |  |  |  |  |
|-----------------------|---|---|---|---|---|
| | 16 | 12 | 8 | 4 | 0 |

QWLD

special arrangements

front face of pin insert or rear of socket insert illustrated

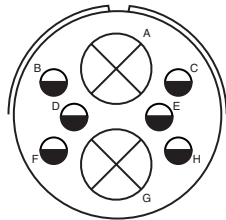

32-57

**

Insert Arrangement
Service Rating
Number of Contacts
Contact Size

6 2
12 0 (Coax) RG-71/U

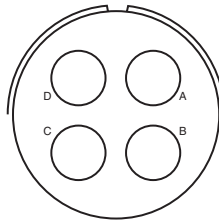

32-58

-

4 (Coax) RG-161U
or RG-179/U

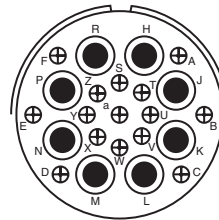

32-60

A

15 8
16 8 (Coax) RG-124/U

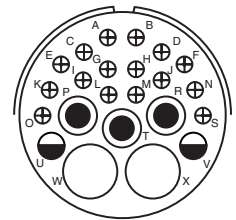

32-62

**

2 1 2 16 2
4 8 12 16 8 (Coax)RG-124/U

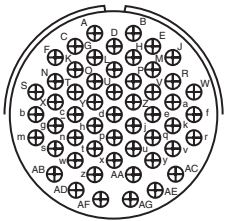

32-64

Inst.

Insert Arrangement
Service Rating
Number of Contacts
Contact Size

54
16

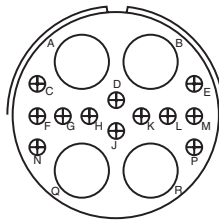

32-68

A

12 4
16 4 (Coax) RG-58C/U

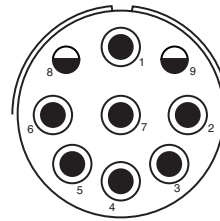

32-75

8, 9 = D

2 7
12 8 (Coax) RG-180B/U

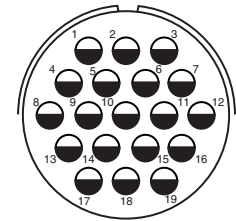

32-76

A

19
12

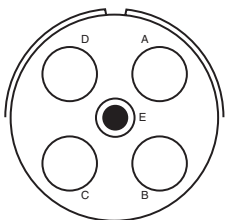

32-79

D

Insert Arrangement
Service Rating
Number of Contacts
Contact Size

4 1
4 8

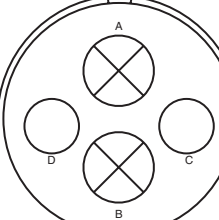

36-51

D

2 2
0 4

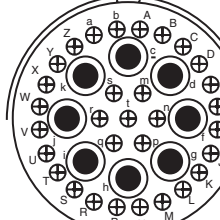

36-54

A

8 31
8 16

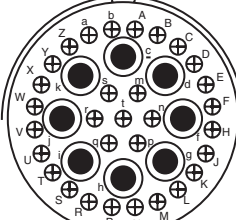

36-55

A

31 8
16 8 for #6 wire

**Consult Sidney, NY for service rating of power contacts.



QWLD special arrangements

front face of pin insert or rear of socket insert illustrated

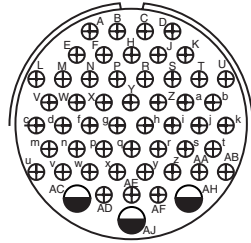

36-59
A

Insert Arrangement
Service Rating
Number of Contacts
Contact Size

50 3
16 12 for #10 wire

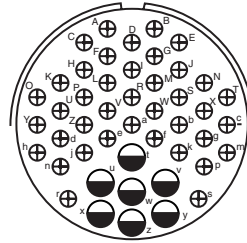

36-60
**

40 7
16 12 for #10 wire

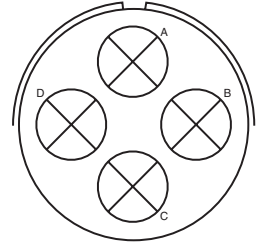

36-64
-

4
0 (Coax) RG-11/U
RG-12/U or RG-13/U

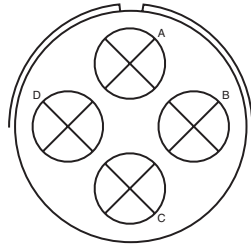

36-65
-

Insert Arrangement
Service Rating
Number of Contacts
Contact Size

4
0 (Coax) RG-59/U, RG-62/U
or RG-71/U

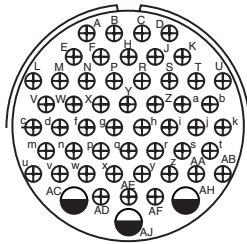

36-71
A

3 50
12 16

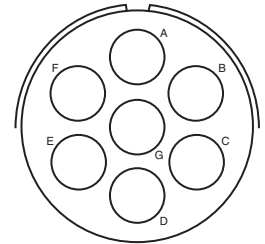

36-73
-

7
4 (Coax) RG-62B/U

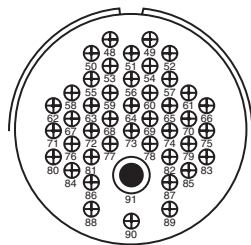

36-74
A

Insert Arrangement
Service Rating
Number of Contacts
Contact Size

43 1
16 8 (Coax) RG-187/U

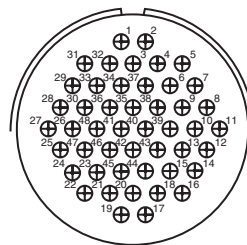

36-75
A

48
16 for #14 wire

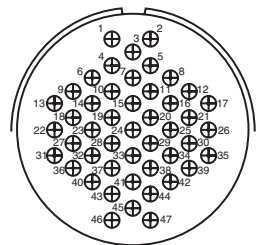

36-76
A

47
16

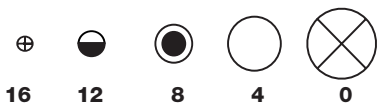

CONTACT LEGEND

16 12 8 4 0

**Consult Sidney, NY for service rating of power contacts.

QWLD

special arrangements

front face of pin insert or rear of socket insert illustrated

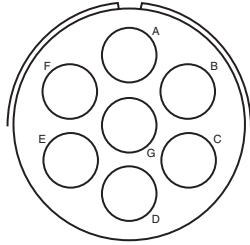

36-77
D
7
4

Insert Arrangement
Service Rating
Number of Contacts
Contact Size

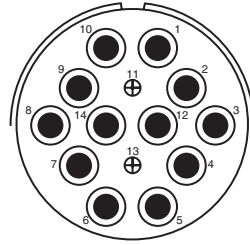

36-78
A
2 12
16 8

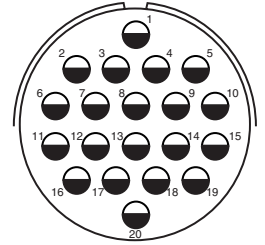

36-79
A
20
12

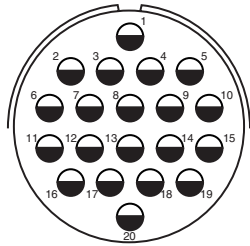

36-80
A
20
12 for #10 wire

Insert Arrangement
Service Rating
Number of Contacts
Contact Size

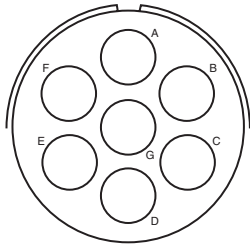

36-83
-
7
4 (Coax) RG-58/U

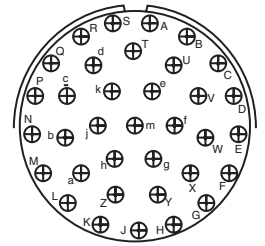

36-85
M = D; Bal. = A
35
16 for #12 wire

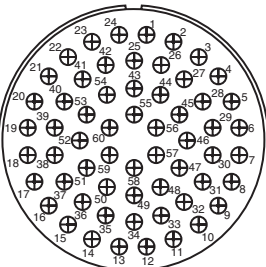

40-53
A
60
16

Insert Arrangement
Service Rating
Number of Contacts
Contact Size

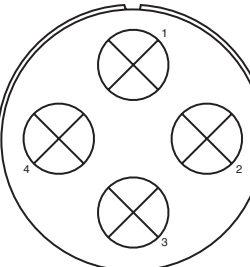

40-57
E
4
0

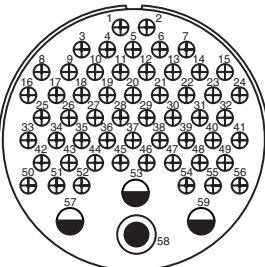

40-61
A
1 3 55
8 12 16

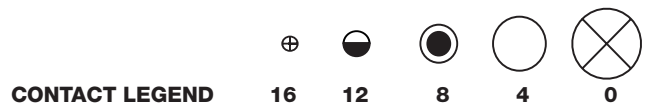

QWLD special arrangements

front face of pin insert or rear of socket insert illustrated

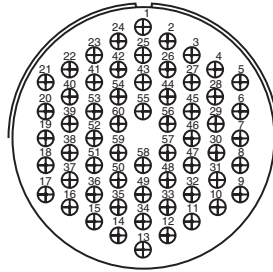

Insert Arrangement 40-62
Service Rating A
Number of Contacts 60
Contact Size 16

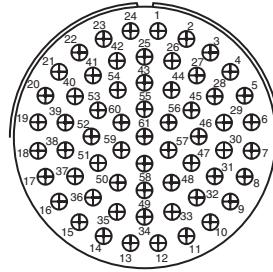

Insert Arrangement 40-63
Service Rating A
Number of Contacts 61
Contact Size 16 for #14 wire

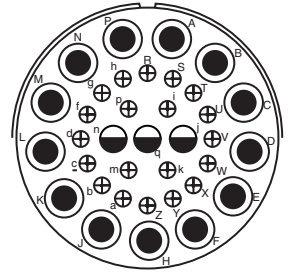

Insert Arrangement 40-64
Service Rating -
Number of Contacts 3 20 13
Contact Size 12 16 8 (Coax) RG-124/U

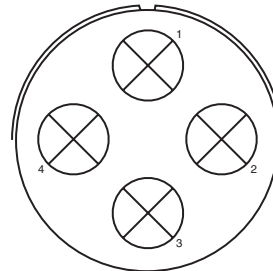

Insert Arrangement 40-66
Service Rating -
Number of Contacts 4
Contact Size 0 (Coax) RG-63B/U

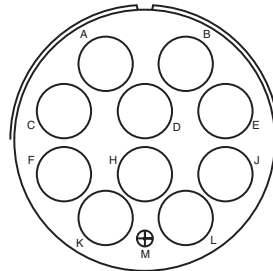

Insert Arrangement 40-67
Service Rating A
Number of Contacts 1 10
Contact Size 16 4 (Coax) RG-59/U

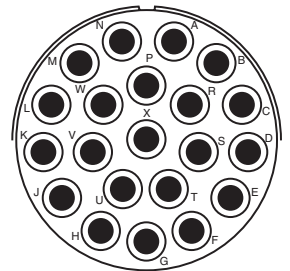

Insert Arrangement 40-68
Service Rating A
Number of Contacts 21
Contact Size 8

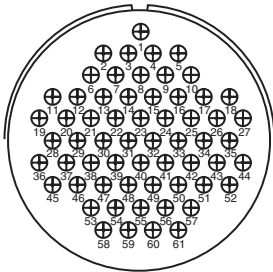

Insert Arrangement 40-70
Service Rating A
Number of Contacts 61
Contact Size 16

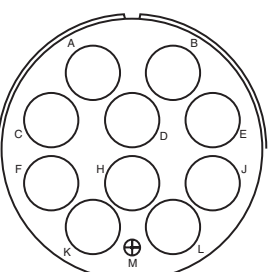

Insert Arrangement 40-72
Service Rating A
Number of Contacts 1 10
Contact Size 16 4 (Coax) RG-9B/U

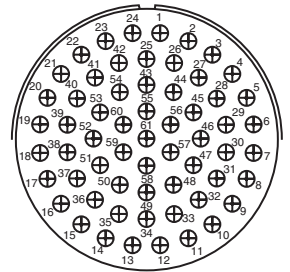

Insert Arrangement 40-73
Service Rating A
Number of Contacts 61
Contact Size 16

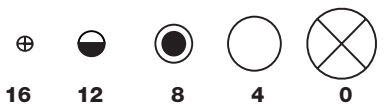

QWLD special arrangements

front face of pin insert or rear of socket insert illustrated

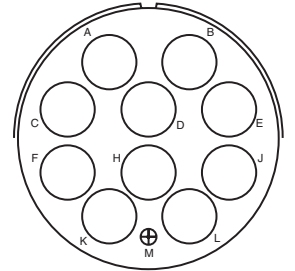
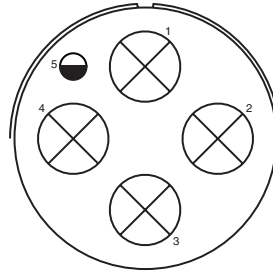
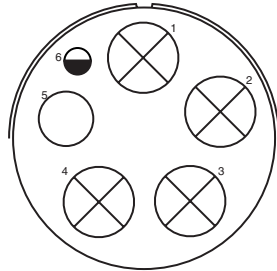

Insert Arrangement
Service Rating
Number of Contacts
Contact Size

40-74
A
1 1 4
12 4 (Coax) RG-62/U 0 (Coax) RG-9B/U
or RG-214/U

40-75
E
1 4
12 0

40-80
A
1 10
16 4

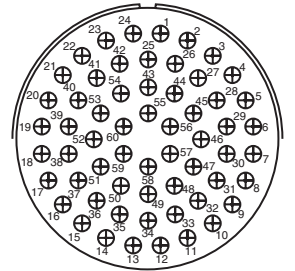
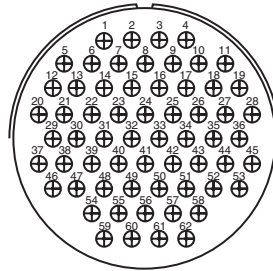
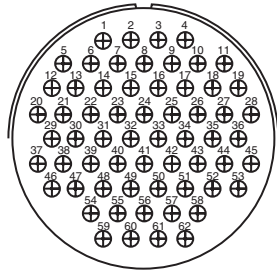

Insert Arrangement
Service Rating
Number of Contacts
Contact Size

40-81
A
62
16 for #14 wire

40-82
A
62
16

40-85
A
60
16 for #14 wire

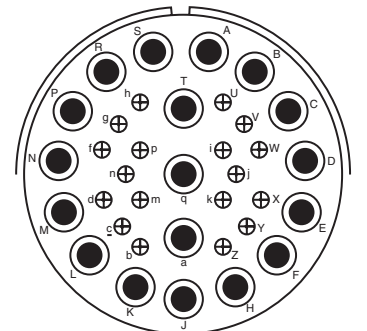
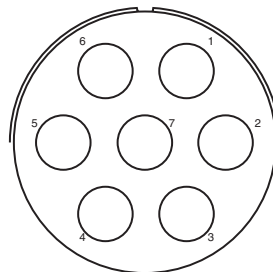
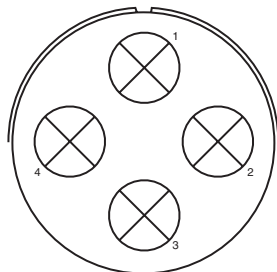

Insert Arrangement
Service Rating
Number of Contacts
Contact Size

40-86
-
4
0 (Coax) RG-115A/U

40-87
D
7
4

44-53
A
18 18
16 8 (Coax) RG-124/U



QWLD special arrangements

front face of pin insert or rear of socket insert illustrated

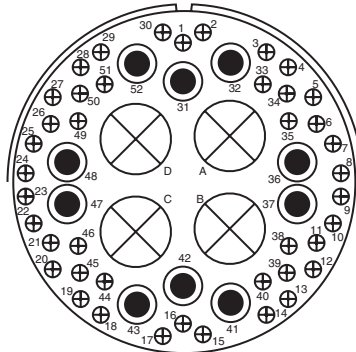

48-51†

A

Insert Arrangement
Service Rating
Number of Contacts
Contact Size

42 10 4
16 8 0 (Coax) RG-41/U

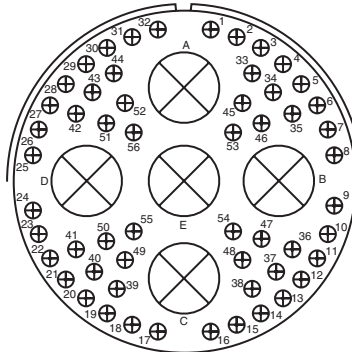

48-52†

A

56 5
16 0 (Coax) RG-41/U

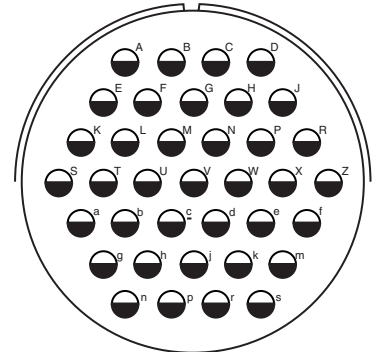

48-53†

D

37
12

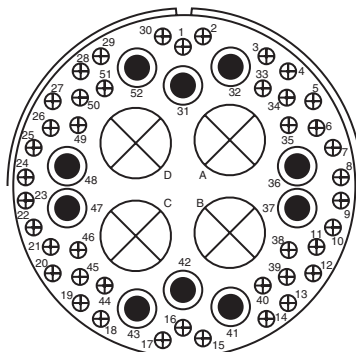

48-54†

A

Insert Arrangement
Service Rating
Number of Contacts
Contact Size

42 10 4
16 8 0 (Coax) RG-59/U

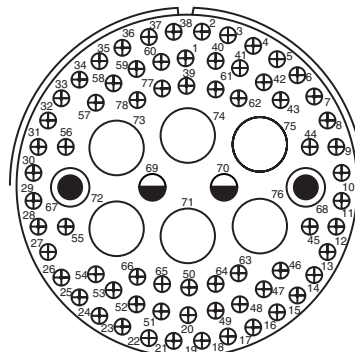

48-55†

A

68 2 2 6
16 12 8 4

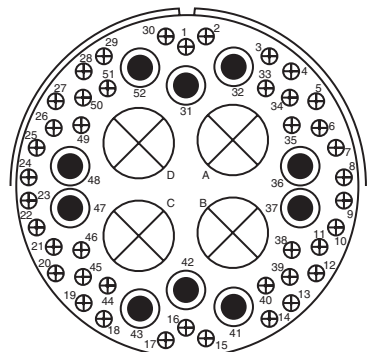

48-57†

A

42 10 4
16 8 0

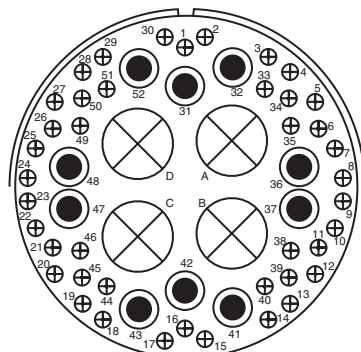

48-60†

A

Insert Arrangement
Service Rating
Number of Contacts
Contact Size

42 10 4
16 8 0 (Coax) RG-214/U

†Consult Sidney, NY for availability

CONTACT LEGEND

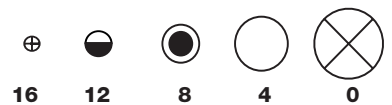

QWLD

thermocouple contact availability

A complete line of cylindrical connectors containing thermocouple insert arrangements is available. The contact layout for a particular arrangement will be found in either the MIL-C-22992, QWLD contact arrangement section, pages 27-38, or the Special contact arrangement section, pages 39-47. All thermocouple contact layouts may contain either iron, alumel, chromel, constantan, standard (copper) or brass (dummy) contacts. See the thermocouple tabulations on the following pages.

The following abbreviations are used in the contact material column in the charts that follow. Also, thermocouple contacts are color coded as shown. (This identification is made by means of small dots of stain on solder well end of the contact.)

| Abbreviation | Material | Color Code |
|--------------|--------------|------------|
| Ir. | Iron | Black |
| Con | Constantan | Yellow |
| Cu. | Copper Alloy | N/A |
| Ch. | Chromel | White |
| Al. | Alumel | Green |
| Dummy | Brass | N/A |

WIRE WELL DATA

| Contact Size | Well Inside Dia. + .004 - .002 | Well Depth + .031 - .000 | Solder Well Barrel Outside Dia. |
|--------------|--------------------------------------|--------------------------------|------------------------------------|
| 12 | .125 | .250 | .166 ±.003 |
| 16 | .094 | .188 | .125 +.002 -.004 |

RECOMMENDED WIRE

| | |
|--------------------|--|
| I Chromel-Alumel | Use wire in accordance with MIL-W-5848 |
| II Iron-Constantan | Use wire in accordance with MIL-W-5845 |

QWLD

thermocouple arrangements

| Shell Size and Arrg. | Similar to MS Arrg. | Total Contacts | Contact Size | | Pin Insert Rotation CW | Contact Material |
|----------------------|---------------------|----------------|--------------|----|------------------------|---|
| | | | 12 | 16 | | |
| 14-59 | 14-53 | 6 | | 6 | None | A = Al.; B = Ch.; C = Ir.; D = Con.; E,F = Cu. |
| 16-52 | 16-11 | 2 | 2 | | 90° | A = Al.; B = Ch. |
| 16-53 | 16-9 | 4 | 2 | 2 | 70° | A = Al.; C = Ch.; B, D = Cu. |
| 16-55 | 16-10 | 3 | 3 | | 45° | A = Al.; B = Ch.; C = Cu. |
| 16-56 | 16-13 | 2 | 2 | | 90° | A = Con.; B = Cu. |
| 16-57 | 16-10 | 3 | 3 | | None | A = Al.; B = Cu.; C = Ch. |
| 16-58 | 16-10 | 3 | 3 | | None | A = Con.; B, C = Cu. |
| 16-60 | 16-13 | 2 | 2 | | None | A = Al.; B = Ch. |
| 16-62 | 16-11 | 2 | 2 | | None | A = Con.; B = Cu. |
| 16-67 | 16-11 | 2 | 2 | | None | A = Al.; B = Ch. |
| 16-68 | 16-9 | 4 | 2 | 2 | None | A, B, C = Ch.; D = Al. |
| 18-51 | 18-12 | 6 | | 6 | None | A = Ir.; B, E = Con.; D = Cu.; C, F = Dummy |
| 18-52 | 18-11 | 5 | 5 | | None | A = Ir.; B = Con.; C = Ch.; D = Al.; E = Dummy |
| 18-53 | 18-12 | 6 | | 6 | None | A, D = Ir.; B, E = Con.; C, F = Dummy |
| 18-54 | 18-15 | 4 | 4 | | None | A, C = Al.; B, D = Ch. |
| 18-56 | 18-1 | 10 | | 10 | 45° | A, C, E, G, I = Ir.; B, D, F, H, J = Con |
| 18-57 | 18-12 | 6 | | 6 | 45° | A, C, E = Al.; B, D, F = Ch. |
| 18-59 | 18-12 | 6 | | 6 | 45° | A, C = Ir.; B, E, F = Con.; D = Cu. |
| 18-60 | 18-11 | 5 | 5 | | 45° | A, D = Al.; B, C = Ch.; E = Al. |
| 18-61 | 18-12 | 6 | | 6 | None | A, C = Ir.; B, D = Con.; E = Ch.; F = Al. |
| 18-62 | 18-12 | 6 | | 6 | None | A, B, D = Ir.; D, E, F = Con. |
| 18-63 | 18-15 | 4 | 4 | | None | A, C = Con.; B, D = Cu. |
| 18-65 | 18-12 | 6 | | 6 | None | A = Ir.; B = Con.; Balance = Cu. |
| 18-66 | 18-1 | 10 | | 10 | None | A, C, E, G, I = Cu.; B, D, F, H, J = Con. |
| 18-67 | 18-12 | 6 | | 6 | None | A, C, E = Cu.; B, D, F = Con. |
| 18-68 | 18-11 | 5 | 5 | | None | A, D = Al.; B, C = Ch.; E = Cu. |
| 18-69 | 18-1 | 10 | | 10 | None | A = Al.; B = Ch.; Balance = Cu. |
| 18-70 | 18-11 | 5 | 5 | | None | A = Ir.; B = Con.; C = Ch.; D = Al.; E = Cu. |
| 18-71 | 18-15 | 4 | 4 | | None | A = Con.; Balance = Cu. |
| 18-72 | 18-15 | 4 | 4 | | None | D = Con.; Balance = Cu. |
| 18-73 | 18-9 | 7 | 2 | 5 | None | A = Al.; D = Ch; Balance = Cu. |
| 18-74 | 18-12 | 6 | | 6 | None | A = Ch.; B = Al.; D = Ir.; E = Cu.; C, F = Con. |
| 18-76 | 18-1 | 10 | | 10 | None | A, C, E, G, I = Al.; B, D, F, H, J = Ch. |
| 18-77 | 18-1 | 10 | | 10 | None | A, C, E, G = Al.; B, D, F, H = Ch.; Bal. = Cu. |
| 18-78 | 18-1 | 10 | | 10 | None | A = Al.; B = Ch.; D, F, H, J = Con.; Bal. = Cu. |
| 18-79 | 18-12 | 6 | | 6 | None | A, F = Ir.; B, E = Con.; C, D = Cu. |
| 18-80 | 18-15 | 4 | 4 | | None | A, C = Cu.; B, D = Con. |
| 18-81 | 18-1 | 10 | | 10 | None | E, G = Con.; Bal. = Cu. |
| 18-82 | 18-1 | 10 | | 10 | None | E, G = Con.; F, H = Ir.; Bal = Cu. |
| 20-52 | 20-4 | 4 | 4 | | 315° | A= Ir.; B = Con.; C = Ch.; D = Al |
| 20-56 | 20-7 | 8 | | 8 | 45° | A, B, G, H = Ir.; C, D, E, F = Con. |
| 20-60 | 20-7 | 8 | | 8 | 45° | D = Ch.; E = Al.; Balance = Cu. |
| 20-61 | 20-29 | 17 | | 17 | 45° | A, B, M = Cu.; Balance = Con. |
| 20-62 | 20-15 | 7 | 7 | | 80° | A, C, E, = Al.; B, D, F, = Ch.; G = Cu. |

QWLD

thermocouple arrangements

| Shell Size and Arrg. | Similar to MS Arrg. | Total Contacts | Contact Size | | Pin Insert Rotation CW | Contact Material |
|----------------------|---------------------|----------------|--------------|----|------------------------|--|
| | | | 12 | 16 | | |
| 20-64 | 20-27 | 14 | | 14 | None | A = Al.; C = Ch.; Balance = Cu. |
| 20-65 | 20-27 | 14 | | 14 | None | A, B, C, D, E, F, G = Ir.; H, I, J, K, L, M, N = Con. |
| 20-67 | 20-16 | 9 | 2 | 7 | None | H = Al.; I = Ch.; Balance = Cu. |
| 20-68 | 20-7 | 8 | | 8 | None | A, B, G, H = Con.; C, D, E, F = Cu. |
| 20-69 | 20-27 | 14 | | 14 | None | A, B, C, D, E, F, G = Cu.; H, I, J, K, L, M, N = Con. |
| 20-70 | 20-29 | 17 | | 17 | None | A, C, E, G, J, L, N, R, T = Ir.; B, D, F, H, K, M, P, S = Con. |
| 20-71 | 20-29 | 17 | | 17 | None | S = Al.; R = Ch.; Balance = Cu. |
| 20-74 | 20-29 | 17 | | 17 | None | A, C, E, G, J, L, N, R = Ir.; B, D, F, H, K, M, P, S = Con.; T = Cu. |
| 20-75 | 20-15 | 7 | 7 | | None | G = Al.; Balance = Ch. |
| 20-77 | 20-16 | 9 | 2 | 7 | None | A = Con.; Balance = Std. |
| 20-80 | 20-27 | 14 | | 14 | None | A, C, E, G, I, K, M = Cu.; B, D, F, H, J, L, N = Con. |
| 20-81 | 20-27 | 14 | | 14 | None | A, C, E, G, I, K, M = Ch.; B, D, F, H, J, L, N = Al |
| 20-82 | 20-29 | 17 | | 17 | None | A, C, E, G, J, L, N, R = Al.; B, D, F, H, K, M, P, S = Ch.; T = Cu. |
| 20-85 | 20-33 | 11 | | 11 | None | K, L = Al.; Bal. = Ch. |
| 20-87 | 20-29 | 17 | | 17 | None | A, C, E, G, J, L, N, R = Con.; Bal. = Cu. |
| 20-88 | 20-27 | 14 | | 14 | None | A, C, E = Al.; B, D, F = Ch.; G, H, K, N = Con.; Bal. = Cu. |
| 20-89 | 20-27 | 14 | | 14 | None | B, D, F, H, J, L = Al.; A, C, E, G, I, K = Ch., M, N = Cu. |
| 20-90 | 20-27 | 14 | | 14 | None | C, G, I = Ch.; K, L, M = Al.; Bal. = Cu. |
| 20-91 | 20-27 | 14 | | 14 | None | I = Ch.; K = Al.; Bal. = Cu. |
| 20-92 | 20-7 | 8 | | 8 | None | A = Al.; H = Cu.; Bal. = Ch. |
| 20-93 | 20-27 | 14 | | 14 | None | A = Ch.; B = Al.; Bal. = Cu. |
| 20-94 | 20-15 | 7 | 7 | | None | A, C, E = Al.; B, D, F = Ch.; G = Cu. |
| 20-99 | 20-33 | 11 | | 11 | None | A = Al.; Bal. = Ch. |
| | | | | | | |
| 22-57 | 22-14 | 19 | | 19 | 45° | A, C, E, G, J, L, N, R = Ir.; B, D, F, H, K, M, P, S = Con.; T, U, V = Cu. |
| 22-60 | 22-14 | 19 | | 19 | 45° | U = Al.; N = Ch.; Bal. = Cu. |
| 22-62 | 22-23 | 8 | 8 | | 60° | A, B, F, G = Al.; C, D, E, H = Ch. |
| 22-68 | 22-19 | 14 | | 14 | 45° | A, C, E, G, J, L, M = Ir.; B, D, F, H, K, P, N = Con. |
| 22-69 | 22-19 | 14 | | 14 | 45° | A, C, E, G, J, L, M = Cu.; B, D, F, H, K, P, N = Con. |
| 22-71 | 22-14 | 19 | | 19 | None | V = Al.; U = Ch.; Balance = Cu. |
| 22-72 | 22-5 | 6 | 2 | 4 | None | B = Al.; E = Ch.; Balance = Cu. |
| 22-73 | 22-5 | 6 | 2 | 4 | None | E = Al.; B = Ch.; Balance = Cu. |
| 22-74 | 22-23 | 8 | 8 | | None | A, C, E, G = Ir.; B, D, F, H = Con. |
| 22-75 | 22-23 | 8 | 8 | | None | A = Al.; B, D, G, H = Cu.; C = Ch.; E = Ir.; F = Con |
| 22-76 | | 21 | | 21 | None | W = Con.; Balance = Cu. |
| 22-77 | 22-19 | 14 | | 14 | None | B, D, F, H, J, K, M, P = Cu.; A, E, L = Ir.; C, G, N = Con. |
| 22-78 | 22-14 | 19 | | 19 | None | A, C, E, G, H, K, M, P, R, T = Con.; Balance = Cu. |
| 22-79 | 22-10 | 4 | | 4 | None | A, C = Con.; B, D = Cu. |
| 22-82 | 22-14 | 19 | | 19 | None | A, C, E, G, J, L, N, R, T = Ir.; B, D, F, H, K, M, P, S, U = Con.; V = Cu. |
| 22-83 | 22-18 | 8 | | 8 | None | A, C, E, G = Al.; B, D, F, H = Ch. |
| 22-84 | 22-14 | 19 | | 19 | None | A, C, S = Ch.; B, D, T = Al.; Bal. = Cu. |
| 22-85 | 22-19 | 14 | | 14 | None | A, C, E, G, J, L, N = Al.; B, D, F, H, K, M, P = Ch. |
| 22-89 | 22-88 | 7 | 7 | | None | A, C, E = Ir.; B, D, F = Con.; G = Cu. |
| | | | | | | |
| 24-56 | 24-20 | 11 | 2 | 9 | 45° | E = Al.; F = Ch.; Balance = Cu. |
| 24-57 | 24-26 | 24 | | 24 | 45° | A, C, J, V, Y, W, K, E, H, U, S, M = Ch.; Balance = Al |
| 24-62 | 24-28 | 24 | | 24 | None | A, C, E, G = Ir.; B, D, F, H = Con.; R, T = Ch.; S, U = Al.; Balance = Cu. |

QWLD

thermocouple arrangements

| Shell Size and Arrg. | Similar to MS Arrg. | Total Contacts | Contact Size | | Pin Insert Rotation CW | Contact Material |
|----------------------|---------------------|----------------|--------------|----|------------------------|---|
| | | | 12 | 16 | | |
| 24-63 | 24-28 | 24 | | 24 | None | A, C, E, G, J, L, K, N, S, U, W, Y = Cu.; B, D, F, H, Q, R, M, P, T, V, X, Z = Con. |
| 24-64 | 24-5 | 16 | | 16 | None | A, B, C, D, E, F, G, H = Ir.; J, K, L, M, N, P, R, S = Con. |
| 24-68 | 24-28 | 24 | | 24 | None | D = Con.; Balance = Cu. |
| 24-81 | 24-7 | 16 | 2 | 14 | None | A, C, E, G, I, K, M, N, P = Cu.; B, D, F, H, J, L, O = Con. |
| 24-88 | 24-28 | 24 | | 24 | None | A, B, C, D, E, F, G, H, J, K, L, M = Con.; Bal. = Ir. |
| 24-91 | 24-5 | 16 | | 16 | None | A, B, C, D, E, F, G, H = Al.; J, K, L, M, N, P, R, S = Ch. |
| | | | | | | |
| 28-53 | 28-11 | 22 | 4 | 18 | 45° | J, L = Al.; K, M = Ch.; Balance = Cu. |
| 28-58 | 28-20 | 14 | 10 | 4 | 45° | A, C, E, G, K, M = Al.; B, D, F, H, L, N = Ch.; J, P = Cu. |
| 28-61 | 28-21 | 37 | | 37 | 45° | A, C, J, Z, m, r, n, a, K, F, H, X, k, h, T, M, N, d = Ir.; Balance = Con. |
| 28-63 | 28-20 | 14 | 10 | 4 | 45° | A, C, E, G, J = Al.; B, D, F, H, P = Ch.; Balance = Cu. |
| 28-64 | 28-15 | 35 | | 35 | None | A, d = Al.; B, j = Ch.; C, D, E, F, G, N, P, R, S, H, J, K, L, M, W, X, Y, Z = Con.; Balance = Cu. |
| 28-65 | 28-12 | 26 | | 26 | None | A, C, E, G, J, L, N, R, T, V = Ir.; X, Z = Al.; B, D, F, H, K, M, P, S, U, W = Con.; Y, a = Ch.; b, d = Cu. |
| 28-67 | 28-16 | 20 | | 20 | None | U = Con.; Balance = Cu. |
| 28-68 | 28-15 | 35 | | 35 | 45° | T = Al.; U = Ch.; Balance = Cu. |
| 28-69 | 28-11 | 22 | 4 | 18 | None | G = Al.; R = Ch.; Balance = Cu. |
| 28-70 | 28-11 | 22 | 4 | 18 | None | A = Al.; B = Ch.; Balance = Cu. |
| 28-77 | 28-11 | 22 | 4 | 18 | None | J = Con.; Balance = Cu. |
| 28-81 | 28-21 | 37 | | 37 | None | A, D, S, Z, n, s = Ir.; B, J, K, f, g, r = Con.; G, L, P, b, e, j = Al.; F, H, T, X, h, k = Ch.; Balance = Cu. |
| 28-85 | 28-11 | 22 | 4 | 18 | 45° | K, M = Al.; J, L = Ch.; Bal. = Cu. |
| 28-91 | 28-9 | 12 | 6 | 6 | None | M = Ir.; L = Con.; Bal. = Cu. |
| 28-94 | 28-12 | 26 | | 26 | None | B, D, F, H, K, M, P, S, U, W, Y, a, d = Al.; Bal. = Ch. |
| 28-98 | 28-21 | 37 | | 37 | None | M = Al.; F = Ch.; Bal. = Cu. |
| 28-99 | 28-12 | 26 | | 26 | None | B, D, F, H, K, M, P, S, U, W, Y, a = Con.; Bal. = Cu. |
| 28-AC | 28-16 | 20 | | 20 | None | A, C, E, G, J, L = Ir.; B, D, F, N, K, M = Con.; Bal. = Cu. |
| 28-AD | 28-21 | 37 | | 37 | 45° | A, C, F, H, J, K, M, N, T, X, Z, a, d, h, k, m, n, r = Cu.; Bal. = Cu. |
| 28-AE | 28-21 | 37 | | 37 | None | A, C, E, G, J, L, N, R, T, V, X, a, c, e, g, j, m, p, s = Cu.; Bal. = Con. |
| 28-AF | 28-18 | 12 | | 12 | None | A, C, E, G, J, L = Ch.; Bal. = Al. |
| 28-AG | 28-12 | 26 | | 26 | None | A, C, E, G, J, L, N, R = Al.; B, D, F, H, K, M, P, S = Ch.; Bal. = Cu. |
| 28-AK | 28-21 | 37 | | 37 | 45° | A, B, C, D, J, K, L, M, N, P, a, b, c, d, e, m, p = Ch.; n = Cu.; Bal. = Al. |
| | | | | | | |
| 32-51 | 32-8 | 30 | 6 | 24 | 90° | M = Ch.; N = Al.; Balance = Cu. |
| 32-55 | 32-8 | 30 | 6 | 24 | 125° | M, N = Ch.; O, P = Al.; Balance = Cu. |
| 32-91 | 32-64 | 54 | | 54 | None | A, C, E, G, J, L, N, P, S, U, W, Y, a, c, e, g, j, m = Ir.; B, D, F, H, K, M, O, R, T, V, X, Z, b, d, f, h, k, n = Con.; Bal. = Cu. |
| | | | | | | |
| 36-53 | 36-7 | 47 | 7 | 40 | 45° | u, v, w = Al.; x, y, z = Ch.; Balance = Cu. |
| 36-56 | 36-10 | 48 | | 48 | None | A, C, E, G, L, J, H, P, R, T, V, X, Z, b, d, f, h, k, q, n, m, u, w, y = Con.; Bal. = Cu. |
| 36-57 | 36-8 | 47 | 1 | 46 | None | W = Al.; f = Ch.; Balance = Cu. |
| 36-58 | 36-15 | 35 | | 35 | None | H = Al.; G = Ch.; Balance = Cu. |
| 36-61 | 36-15 | 35 | | 35 | None | A, C, E, J, K, L, M, N, P, R, T, V, f, X, Y, h, j, c = Con.; Balance = Cu. |
| 36-62 | 36-10 | 48 | | 48 | None | A, C, E = Al.; B, D, F = Ch.; Balance = Cu. |
| 36-82 | 36-52* | 52 | | 52 | None | v, g = Ir.; p, y, c = Con.; x = Ch.; Balance = Cu. |

* Amphenol arrangement

QWLD

thermocouple arrangements

| Shell Size and Arrg. | Similar to MS Arrg. | Total Contacts | Contact Size | | Pin Insert Rotation CW | Contact Material |
|----------------------|---------------------|----------------|--------------|-----|------------------------|--|
| | | | 12 | 16 | | |
| 36-86 | 36-10 | 48 | | 48 | None | A, C, E, G, J, L, N, P, R, T, V, X = Al.; B, D, F, H, K, M, O, Q, S, U, W, Y = Ch.; z, b, d, f, h, k, n, q, s, u, w, y = Con.; a, c, e, g, j, m, p, r, t, v, x, z = Cu. |
| 36-88 | 36-52 | 52 | | 52 | None | A, C, E, H, K, M, P, S, U, W, Y, a, c, f, h, j, m, p, r, t, v, x, z, AB, AD, AF = Cu.; Bal. = Con. |
| 40-58 | 40-56* | 85 | | 85 | None | A, C, E, H, K, M, P, S, U, W, Y, a, c, f, h, j, m, p, r, t, v, x, z, AB, AD, AF, AJ, AL, AN, AP, AS, AU, AW, AY, BA, BC, BE, BH, BK, BM, BP, BS, BU = Ir.; Balance = Con. |
| 40-59 | 40-56* | 85 | | 85 | None | B = Ch.; C = Con.; Balance = Cu. |
| 40-77 | 40-53* | 60 | | 60 | None | 55, 60 = Ir.; 57, 58, 59 = Con.; 56 = Ch.; Balance = Cu. |
| 40-78 | 40-53* | 60 | | 60 | None | 50, 51 = Ir.; 27, 28, 29, 31, 32, 34, 36, 37 = Con.; 25, 39, 40, 41 = Al.; 43, 44, 45, 46, 47, 48, 49, 52, 53, 54 = Ch.; Balance = Cu. |
| 40-88 | 40-53 | 60 | | 60 | None | 1, 3, 5, 7, 9, 11, 13, 15, 17, 19, 21, 23, 25, 27, 29, 31, 33, 35, 37, 39, 41, 43, 45, 47, 49, 51, 53, 55, 57, 59 = Con.; Bal. = Cu. |
| 40-AA | 40-56 | 85 | | 85 | None | A, C, E, H, K, M, P, S, U, W, Y, a, c, f, h, j, m, p, r, t, v, x, z, AB, AD, AF, AJ, AL, AN, AR, AT = Cu.; B, D, F, J, L, N, R, T, V, X, Z, b, d, g, i, k, n, q, s, u, w, y, AA, AC, AE, AH, AK, AM, AP, AS = Con.; AU, AW, AY, BA, BC, BE, BH, BK, BM, BP, BS, BU = Cu.; AV, AX, AZ, BB, BD, BF, BJ, BL, BN, BR, BT, BV = Al. |
| 44-57 | 44-52 | 104 | | 104 | None | A, C, E, G, J, L, etc. = Cu.; B, D, F, H, K, M, etc. = Con. |
| 44-59 | 44-52 | 104 | | 104 | None | 34 = Con.; 70 = Cu. |
| 44-60 | 44-52 | 104 | | 104 | None | A, C, E, etc. = Ch., (52); B, D, F, etc. = Al., (52) |
| 44-62 | 44-52 | 104 | | 104 | None | BY, BZ, CA, CB, CC, CD, CE, CR = Al.; CH, CJ, CK, CL, CM, CN, CP, CS = Ch.; Bal. = Cu. |

* Amphenol arrangement

MIL-C-22992, QWLD MS17343 or 10-1940XX wall mount receptacle

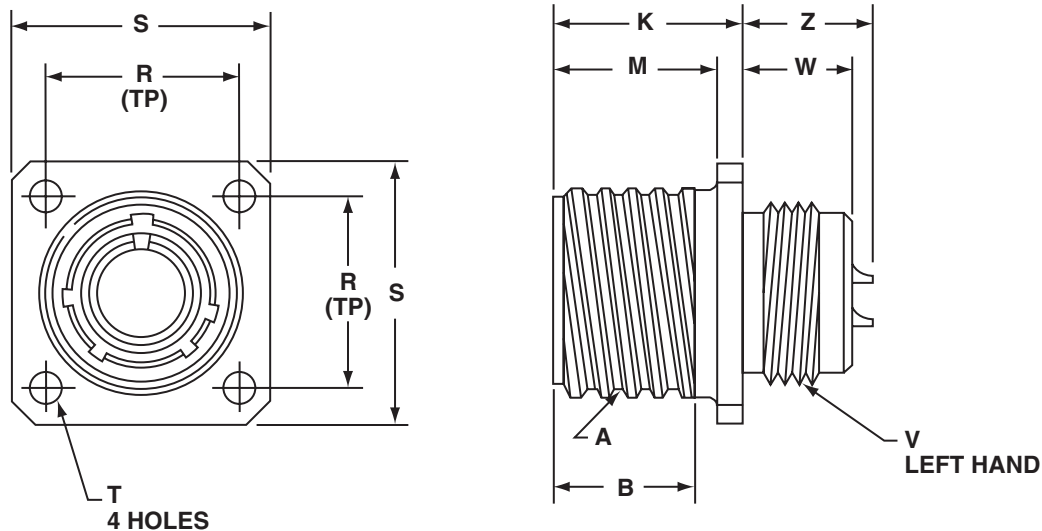

All dimensions for reference only.

| Part Number* | Shell Size | A Thread Class 2A (Plated) 0.1P-0.2L Double Stub | B Min Full Thd | K $+0.021$ -0.020 | M $+0.010$ -0.000 | R (TP) | S $+0.021$ -0.020 | T Dia $+0.004$ -0.003 | V Thread Class 2A-LH (Plated) | W ± 0.010 | Z Max |
|--------------|------------|--|----------------|---------------------|---------------------|--------|---------------------|-------------------------|-------------------------------|---------------|-------|
| 10-194013 | 12 | .8750 | .672 | .937 | .797 | .906 | 1.188 | .150 | .750-20UNEF | .640 | .700 |
| 10-194015 | 14 | 1.0000 | .672 | .937 | .797 | .969 | 1.281 | .150 | .875-20UNEF | .640 | .700 |
| 10-194017 | 16 | 1.1250 | .672 | .937 | .797 | 1.062 | 1.375 | .150 | 1.000-20UNEF | .640 | .700 |
| 10-194018 | 18 | 1.2500 | .672 | .953 | .797 | 1.156 | 1.500 | .177 | 1.125-18UNEF | .625 | .686 |
| 10-194020 | 20 | 1.3750 | .672 | .953 | .797 | 1.250 | 1.625 | .177 | 1.250-18UNEF | .625 | .686 |
| 10-194022 | 22 | 1.5000 | .672 | .953 | .797 | 1.375 | 1.750 | .177 | 1.375-18UNEF | .625 | .686 |
| 10-194024 | 24 | 1.7500 | .672 | 1.047 | .859 | 1.562 | 2.000 | .177 | 1.625-18UNEF | .594 | .585 |
| 10-194028 | 28 | 2.0000 | .672 | 1.047 | .859 | 1.750 | 2.250 | .177 | 1.875-16UN | .594 | .591 |
| 10-194032 | 32 | 2.2500 | .672 | 1.109 | .922 | 1.938 | 2.500 | .209 | 2.0625-16UNS | .530 | .528 |
| 10-194036 | 36 | 2.5000 | .672 | 1.109 | .922 | 2.188 | 2.750 | .209 | 2.3125-16UNS | .530 | .528 |
| 10-194040 | 40 | 2.7500 | .672 | 1.109 | .922 | 2.375 | 3.000 | .209 | 2.625-16UN | .703 | .528 |
| 10-194044 | 44 | 3.0000 | .672 | 1.109 | .922 | 2.625 | 3.250 | .209 | 2.875-16UN | .703 | .770 |
| 10-194048† | 48† | 3.2500 | .672 | 1.109 | .922 | 2.875 | 3.500 | .209 | 3.125-16UN | .703 | .770 |

*To complete 10- part number or to complete MS part number, see how to order, pg. 22.

†Shell size 48 available in proprietary versions only. Consult Sidney, NY for availability and ordering information.

MIL-C-22992, QWLD MS17345 or 10-1941XX cable connecting plug

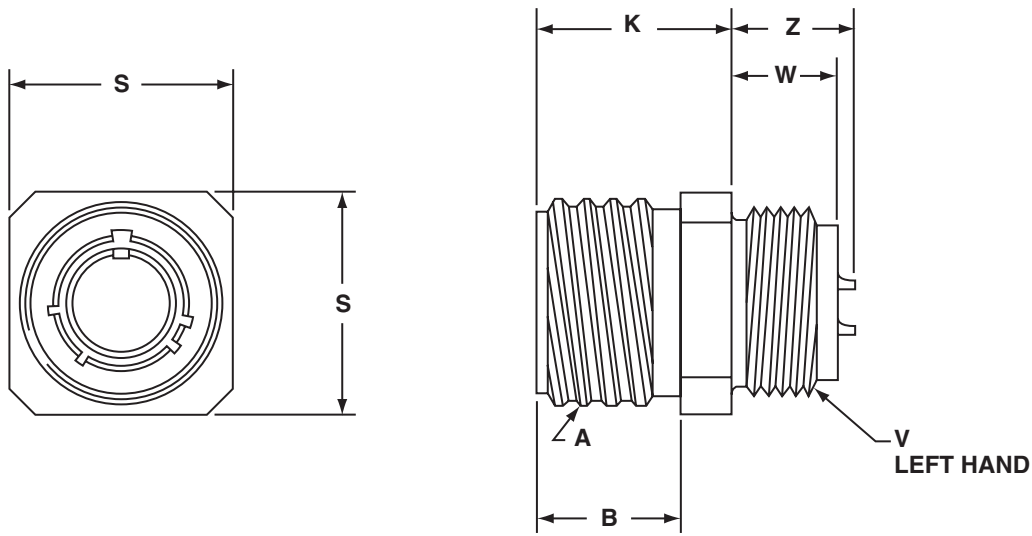

All dimensions for reference only.

| Part Number* | Shell Size | A Thread Class 2A (Plated) 0.1P-0.2L Double Stub | B $+0.016$ -0.000 | K $+0.021$ -0.020 | S $+0.021$ -0.020 | V Thread Class 2A-LH (Plated) | W ± 0.010 | Z Max |
|--------------|------------|--|---------------------|---------------------|---------------------|-------------------------------|---------------|-------|
| 10-194113 | 12 | .8750 | .688 | .938 | 1.000 | .750-20UNEF | .641 | .696 |
| 10-194115 | 14 | 1.0000 | .688 | .938 | 1.094 | .875-20UNEF | .641 | .696 |
| 10-194117 | 16 | 1.1250 | .688 | .938 | 1.281 | 1.000-20UNEF | .641 | .696 |
| 10-194118 | 18 | 1.2500 | .703 | .957 | 1.375 | 1.125-18UNEF | .625 | .680 |
| 10-194120 | 20 | 1.3750 | .703 | .957 | 1.500 | 1.250-18UNEF | .625 | .680 |
| 10-194122 | 22 | 1.5000 | .703 | .957 | 1.625 | 1.375-18UNEF | .625 | .680 |
| 10-194124 | 24 | 1.7500 | .766 | 1.016 | 1.875 | 1.625-18UNEF | .625 | .617 |
| 10-194128 | 28 | 2.0000 | .766 | 1.016 | 2.125 | 1.875-16UN | .625 | .617 |
| 10-194132 | 32 | 2.2500 | .703 | 1.078 | 2.375 | 2.0625-16UN | .563 | .555 |
| 10-194136 | 36 | 2.5000 | .703 | 1.078 | 2.625 | 2.3125-16UN | .563 | .555 |
| 10-194140 | 40 | 2.7500 | .703 | 1.078 | 3.000 | 2.625-16UN | .703 | .555 |
| 10-194144 | 44 | 3.0000 | .703 | 1.078 | 3.250 | 2.875-16UN | .703 | .805 |

*To complete 10- part number or to complete MS part number, see how to order, pg. 22.

MIL-C-22992, QWLD MS17346 or 10-1942XX box mount receptacle

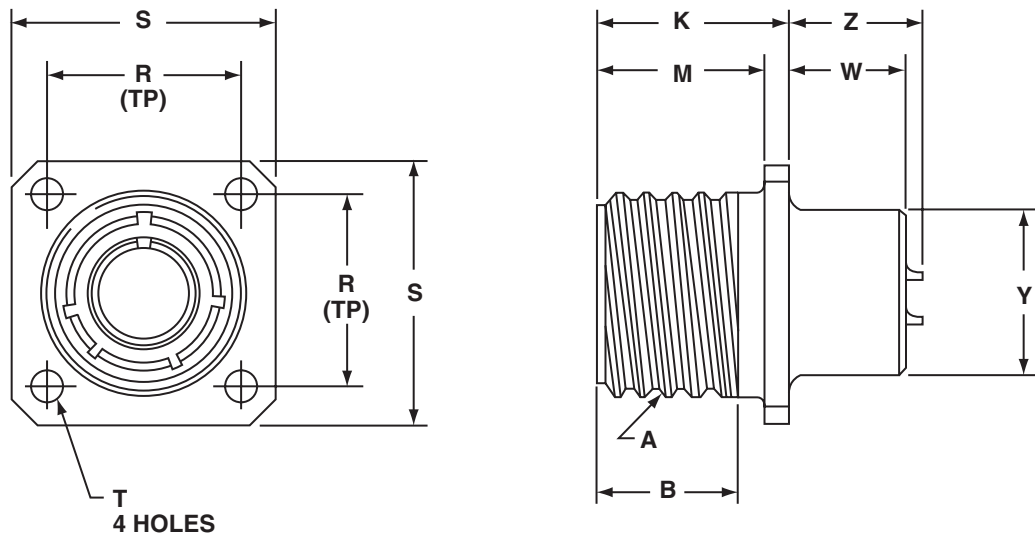

All dimensions for reference only.

| Part Number* | Shell Size | A Thread Class 2A (Plated) 0.1P-0.2L Double Stub | B Min Full Thd | K +.021 - .010 | M +.010 - .000 | R (TP) | S +.021 - .020 | T Dia +.004 - .003 | W +.020 - .030 | Y +.011 - .010 | Z Max |
|--------------|------------|--|----------------|----------------|----------------|--------|----------------|--------------------|----------------|----------------|-------|
| 10-194213 | 12 | .8750 | .672 | .938 | .797 | .906 | 1.188 | .150 | .640 | .640 | .700 |
| 10-194215 | 14 | 1.0000 | .672 | .938 | .797 | .969 | 1.281 | .150 | .640 | .765 | .700 |
| 10-194217 | 16 | 1.1250 | .672 | .938 | .797 | 1.062 | 1.375 | .150 | .640 | .890 | .700 |
| 10-194218 | 18 | 1.2500 | .672 | .953 | .797 | 1.156 | 1.500 | .177 | .625 | 1.015 | .686 |
| 10-194220 | 20 | 1.3750 | .672 | .953 | .797 | 1.250 | 1.625 | .177 | .625 | 1.171 | .686 |
| 10-194222 | 22 | 1.5000 | .672 | .953 | .797 | 1.375 | 1.750 | .177 | .625 | 1.296 | .686 |
| 10-194224 | 24 | 1.7500 | .672 | 1.047 | .859 | 1.562 | 2.000 | .177 | .594 | 1.421 | .585 |
| 10-194228 | 28 | 2.0000 | .672 | 1.047 | .859 | 1.750 | 2.250 | .177 | .594 | 1.625 | .591 |
| 10-194232 | 32 | 2.2500 | .672 | 1.110 | .922 | 1.938 | 2.500 | .209 | .531 | 1.891 | .528 |
| 10-194236 | 36 | 2.5000 | .672 | 1.110 | .922 | 2.188 | 2.750 | .209 | .531 | 2.078 | .528 |
| 10-194240 | 40 | 2.7500 | .672 | 1.110 | .922 | 2.375 | 3.000 | .209 | .531 | 2.312 | .528 |
| 10-194244 | 44 | 3.0000 | .672 | 1.110 | .922 | 2.625 | 3.250 | .209 | .531 | 2.562 | .778 |

*To complete 10- part number or to complete MS part number, see how to order, pg. 22.

MIL-C-22992, QWLD MS17347 or 10-1943XX jam nut receptacle (wall mount)

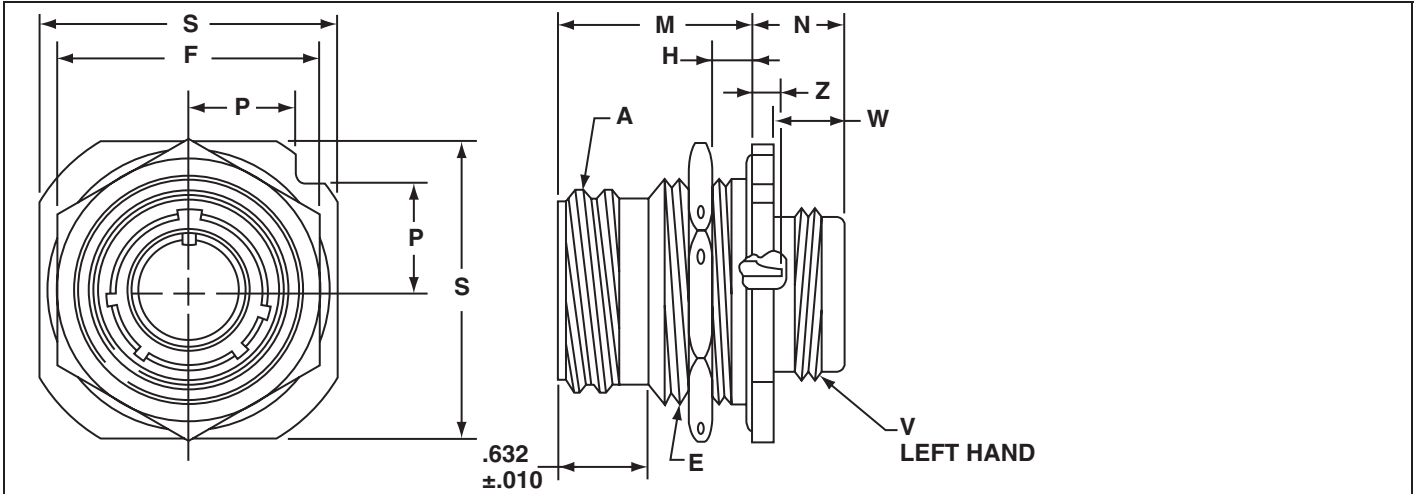

| Shell Size | K Dia. +.005 -.000 | G ±.003 | U ±.005 |
|------------|--------------------------|------------|------------|
| 12,13 | 1.005 | .562 | .688 |
| 14,15 | 1.130 | .606 | .750 |
| 16,17 | 1.255 | .699 | .875 |
| 18 | 1.380 | .739 | .938 |
| 20 | 1.505 | .783 | 1.000 |
| 22 | 1.630 | .830 | 1.062 |
| 24 | 1.880 | .919 | 1.188 |
| 28 | 2.130 | 1.007 | 1.312 |
| 32 | 2.380 | 1.096 | 1.438 |
| 36 | 2.630 | 1.183 | 1.562 |
| 40 | 2.880 | 1.292 | 1.703 |

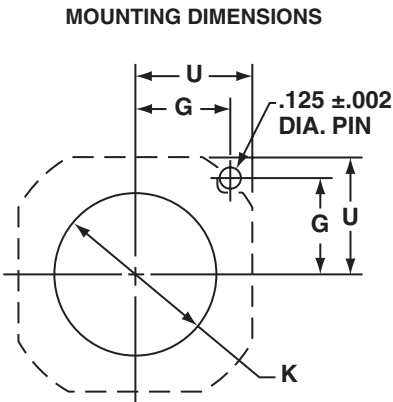

All dimensions for reference only.

| Part Number* | Shell Size | A Thread Class 2A (Plated) 0.1P-0.2L Double Stud | E Thread Class 2A (Plated) | F Hex +.017 -.016 | H Panel Thickness | | M ±.010 | N +.021 -.020 | P ±.010 | S +.011 -.010 | V Thread Class 2A-LH (Plated) | W ±.010 | Z Max |
|--------------|------------|---|----------------------------------|-------------------------|-------------------|------|------------|---------------------|------------|---------------------|-------------------------------------|------------|----------|
| | | | | | Min | Max | | | | | | | |
| 10-194313 | 12 | .8750 | 1.000-20UNEF | 1.250 | .094 | .188 | 1.141 | .641 | .486 | 1.375 | .750-20UNEF | .516 | .483 |
| 10-194315 | 14 | 1.0000 | 1.125-18UNEF | 1.312 | .094 | .188 | 1.141 | .641 | .530 | 1.500 | .875-20UNEF | .516 | .483 |
| 10-194317 | 16 | 1.1250 | 1.250-18UNEF | 1.500 | .094 | .188 | 1.141 | .703 | .623 | 1.750 | 1.000-20UNEF | .516 | .483 |
| 10-194318 | 18 | 1.2500 | 1.375-18UNEF | 1.562 | .094 | .203 | 1.156 | .703 | .663 | 1.875 | 1.125-18UNEF | .516 | .467 |
| 10-194320 | 20 | 1.3750 | 1.500-18UNEF | 1.750 | .094 | .203 | 1.156 | .703 | .707 | 2.000 | 1.250-18UNEF | .516 | .467 |
| 10-194322 | 22 | 1.5000 | 1.625-18UNEF | 1.875 | .094 | .203 | 1.156 | .703 | .751 | 2.125 | 1.375-18UNEF | .516 | .467 |
| 10-194324 | 24 | 1.7500 | 1.875-16UN | 2.125 | .094 | .265 | 1.219 | .703 | .840 | 2.375 | 1.625-18UNEF | .516 | .404 |
| 10-194328 | 28 | 2.0000 | 2.125-16UN | 2.375 | .094 | .277 | 1.231 | .785 | .928 | 2.625 | 1.875-16UN | .516 | .392 |
| 10-194332 | 32 | 2.2500 | 2.375-16UN | 2.625 | .094 | .215 | 1.231 | .785 | 1.017 | 2.875 | 2.0625-16UN | .516 | .392 |
| 10-194336 | 36 | 2.5000 | 2.625-16UN | 2.875 | .094 | .215 | 1.231 | .785 | 1.104 | 3.125 | 2.3125-16UN | .516 | .392 |
| 10-194340 | 40 | 2.7500 | 2.875-16UN | 3.125 | .094 | .215 | 1.231 | .972 | 1.213 | 3.406 | 2.625-16UN | .703 | .392 |
| 10-194344 | 44 | 3.0000 | 3.125-16UN | 3.375 | .094 | .215 | 1.231 | .972 | 1.299 | 3.656 | 2.875-16UN | .703 | .642 |

*To complete 10- part number or to complete MS part number, see how to order, pg. 22.

QWLD 10-1944XX

thru bulkhead receptacle

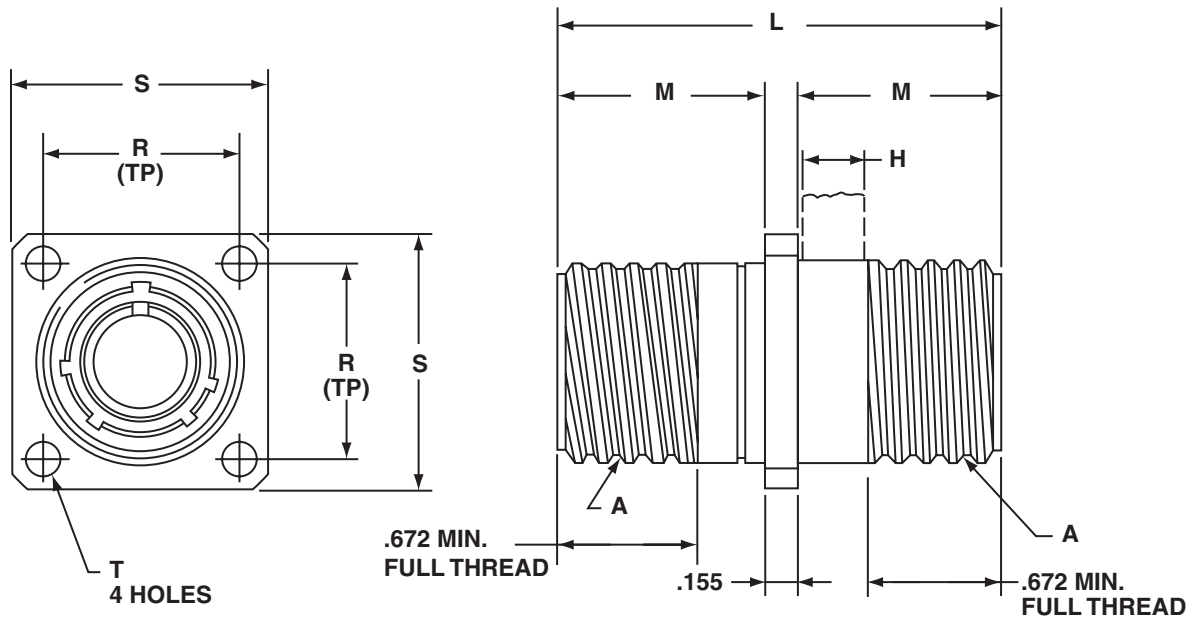

All dimensions for reference only.

| Part Number* | Shell Size | A Thread Class 2A (Plated) 0.1P-0.2L Double Stub | H Max | L ±.015 | M +.000 - .010 | R (TP) | S +.021 - .020 | T Dia +.004 - .003 |
|--------------|------------|--|-------|---------|----------------|--------|----------------|--------------------|
| 10-194413 | 12 | .8750 | .312 | 2.219 | 1.032 | .906 | 1.188 | .150 |
| 10-194415 | 14 | 1.0000 | .312 | 2.219 | 1.032 | .969 | 1.281 | .150 |
| 10-194417 | 16 | 1.1250 | .312 | 2.219 | 1.032 | 1.062 | 1.375 | .150 |
| 10-194418 | 18 | 1.2500 | .312 | 2.219 | 1.032 | 1.156 | 1.500 | .177 |
| 10-194420 | 20 | 1.3750 | .312 | 2.219 | 1.032 | 1.250 | 1.625 | .177 |
| 10-194422 | 22 | 1.5000 | .312 | 2.219 | 1.032 | 1.375 | 1.750 | .177 |
| 10-194424 | 24 | 1.7500 | .312 | 2.219 | 1.032 | 1.562 | 2.000 | .177 |
| 10-194428 | 28 | 2.0000 | .312 | 2.219 | 1.032 | 1.750 | 2.250 | .177 |
| 10-194432 | 32 | 2.2500 | .312 | 2.219 | 1.032 | 1.938 | 2.500 | .209 |
| 10-194436 | 36 | 2.5000 | .312 | 2.219 | 1.032 | 2.188 | 2.750 | .209 |
| 10-194440 | 40 | 2.7500 | .312 | 2.219 | 1.032 | 2.375 | 3.000 | .209 |
| 10-194444 | 44 | 3.0000 | .447 | 2.469 | 1.157 | 2.625 | 3.250 | .209 |
| 10-194448† | 48† | 3.2500 | .447 | 2.469 | 1.157 | 2.875 | 3.500 | .209 |

*To complete 10- part number or to complete MS part number, see how to order, pg. 22.

†Shell size 48 available in proprietary versions only. Consult Sidney, NY for availability and ordering information.

MIL-C-22992, QWLD MS17344 or 10-1946XX straight plug

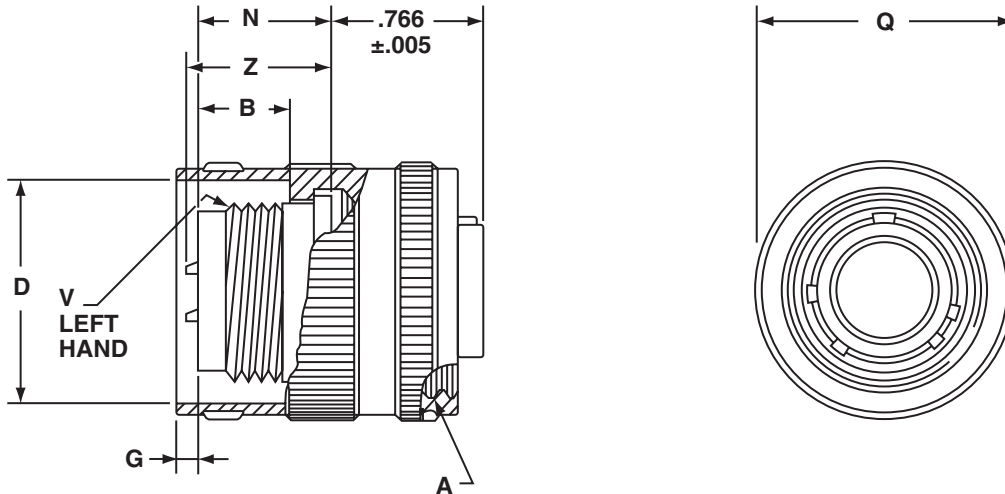

All dimensions for reference only.

| Part Number* | Shell Size | A Thread Class 2B 0.1P-0.2L Double Stub | B | D +.010 - .001 | G | N +.011 - .010 | Q Dia Max | V Thread Class 2A-LH (Plated) | Z Max |
|--------------|------------|---|-----------|----------------|-----------|----------------|-----------|-------------------------------|-------|
| 10-194613 | 12 | .8750 | .519±.020 | .985 | .030±.030 | .738 | 1.156 | .750-20UNEF | .807 |
| 10-194615 | 14 | 1.0000 | .519±.020 | 1.109 | .013±.030 | .738 | 1.281 | .875-20UNEF | .807 |
| 10-194617 | 16 | 1.1250 | .519±.020 | 1.235 | .091±.030 | .738 | 1.469 | 1.000-20UNEF | .807 |
| 10-194618 | 18 | 1.2500 | .519±.020 | 1.359 | .216±.030 | .738 | 1.563 | 1.125-18UNEF | .807 |
| 10-194620 | 20 | 1.3750 | .519±.020 | 1.485 | .216±.030 | .738 | 1.688 | 1.250-18UNEF | .807 |
| 10-194622 | 22 | 1.5000 | .519±.020 | 1.609 | .216±.030 | .738 | 1.844 | 1.375-18UNEF | .807 |
| 10-194624 | 24 | 1.7500 | .519±.020 | 1.859 | .184±.030 | .800 | 2.094 | 1.625-18UNEF | .807 |
| 10-194628 | 28 | 2.0000 | .519±.020 | 2.109 | .184±.030 | .800 | 2.344 | 1.875-16UN | .807 |
| 10-194632 | 32 | 2.2500 | .525±.026 | 2.359 | .190±.033 | .875 | 2.594 | 2.0625-16UNS | .807 |
| 10-194636 | 36 | 2.5000 | .525±.026 | 2.609 | .234±.033 | .875 | 2.844 | 2.3125-16UNS | .807 |
| 10-194640 | 40 | 2.7500 | .710±.023 | 2.922 | .049±.030 | 1.041 | 3.156 | 2.625-16UN | .807 |
| 10-194644 | 44 | 3.0000 | .710±.023 | 3.172 | .049±.030 | 1.041 | 3.406 | 2.875-16UN | .957 |

*To complete 10- part number or to complete MS part number, see how to order, pg. 22.

MIL-C-22992, QWLD MS17348 or 10-1949XX jam nut receptacle (box mount)

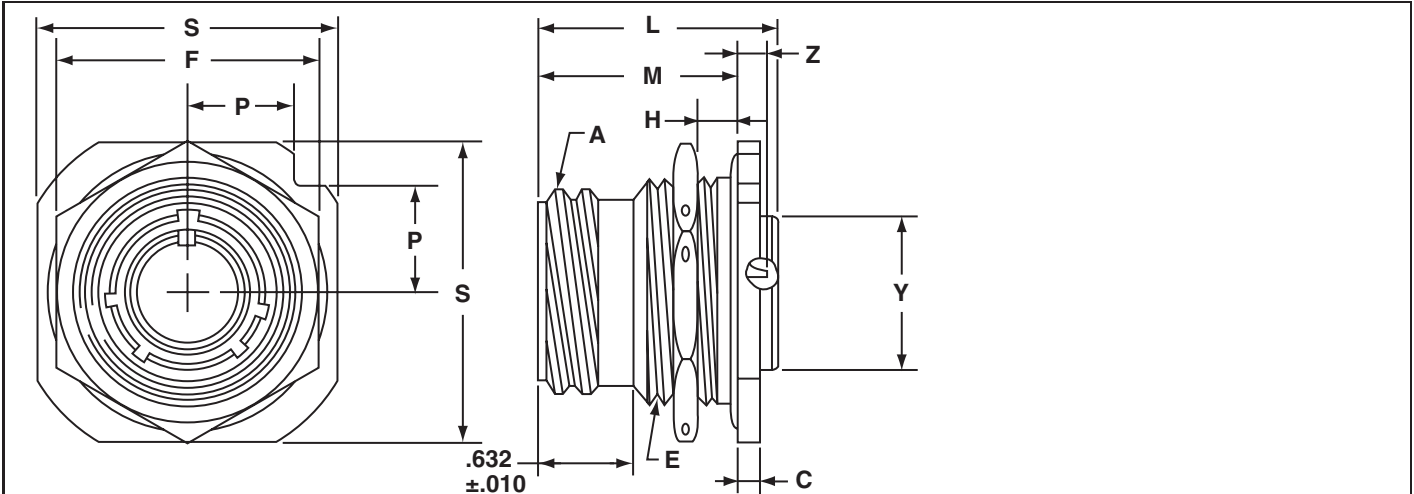

| Shell Size | K Dia. +.005 -.000 | G ±.003 | U ±.005 |
|------------|--------------------------|------------|------------|
| 12,13 | 1.005 | .562 | .688 |
| 14,15 | 1.130 | .606 | .750 |
| 16,17 | 1.255 | .699 | .875 |
| 18 | 1.380 | .739 | .938 |
| 20 | 1.505 | .783 | 1.000 |
| 22 | 1.630 | .830 | 1.062 |
| 24 | 1.880 | .919 | 1.188 |
| 28 | 2.130 | 1.007 | 1.312 |
| 32 | 2.380 | 1.096 | 1.438 |
| 36 | 2.630 | 1.183 | 1.562 |
| 40 | 2.880 | 1.292 | 1.703 |

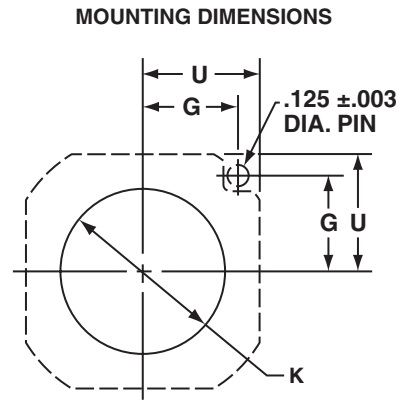

All dimensions for reference only.

| Part Number | Shell Size | A Thread Class 2A (Plated) 0.1P-0.2L Double Stub | C +.006 -.005 | E Thread Class 2A (Plated) | F Hex +.017 -.016 | H Panel Thickness | | L +.011 -.010 | M ±.010 | P ±.010 | S +.011 -.010 | Y +.011 -.010 | Z Max |
|-------------|------------|---|---------------------|----------------------------------|-------------------------|----------------------|------|---------------------|------------|------------|---------------------|---------------------|----------|
| | | | | | | Min | Max | | | | | | |
| 10-194913 | 12 | .8750 | .125 | 1.000-20UNEF | 1.250 | .094 | .297 | 1.578 | 1.235 | .486 | 1.375 | .640 | .389 |
| 10-194915 | 14 | 1.0000 | .125 | 1.125-18UNEF | 1.312 | .094 | .297 | 1.578 | 1.235 | .530 | 1.500 | .765 | .389 |
| 10-194917 | 16 | 1.1250 | .188 | 1.250-18UNEF | 1.500 | .094 | .297 | 1.578 | 1.235 | .623 | 1.750 | .890 | .389 |
| 10-194918 | 18 | 1.2500 | .188 | 1.375-18UNEF | 1.562 | .094 | .266 | 1.578 | 1.203 | .663 | 1.875 | 1.015 | .421 |
| 10-194920 | 20 | 1.3750 | .188 | 1.500-18UNEF | 1.750 | .094 | .266 | 1.578 | 1.203 | .707 | 2.000 | 1.171 | .421 |
| 10-194922 | 22 | 1.5000 | .188 | 1.625-18UNEF | 1.875 | .094 | .266 | 1.578 | 1.203 | .751 | 2.125 | 1.296 | .421 |
| 10-194924 | 24 | 1.7500 | .188 | 1.875-16UN | 2.125 | .094 | .328 | 1.641 | 1.266 | .840 | 2.375 | 1.421 | .358 |
| 10-194928 | 28 | 2.0000 | .219 | 2.125-16UN | 2.375 | .094 | .328 | 1.641 | 1.329 | .928 | 2.625 | 1.625 | .295 |
| 10-194932 | 32 | 2.2500 | .219 | 2.375-16UN | 2.625 | .094 | .328 | 1.641 | 1.329 | 1.017 | 2.875 | 1.891 | .295 |
| 10-194936 | 36 | 2.5000 | .219 | 2.625-16UN | 2.875 | .094 | .328 | 1.641 | 1.329 | 1.104 | 3.125 | 2.078 | .295 |
| 10-194940 | 40 | 2.7500 | .219 | 2.875-16UN | 3.125 | .094 | .328 | 1.641 | 1.329 | 1.213 | 3.406 | 2.312 | .295 |
| 10-194944 | 44 | 3.0000 | .219 | 3.125-16UN | 3.375 | .094 | .328 | 1.641 | 1.329 | 1.299 | 3.656 | 2.562 | .545 |

*To complete 10- part number or to complete MS part number, see how to order, pg. 22.

MIL-C-22992, QWLD Accessories

M85049 or 10-522958

cable sealing adapters (plug)

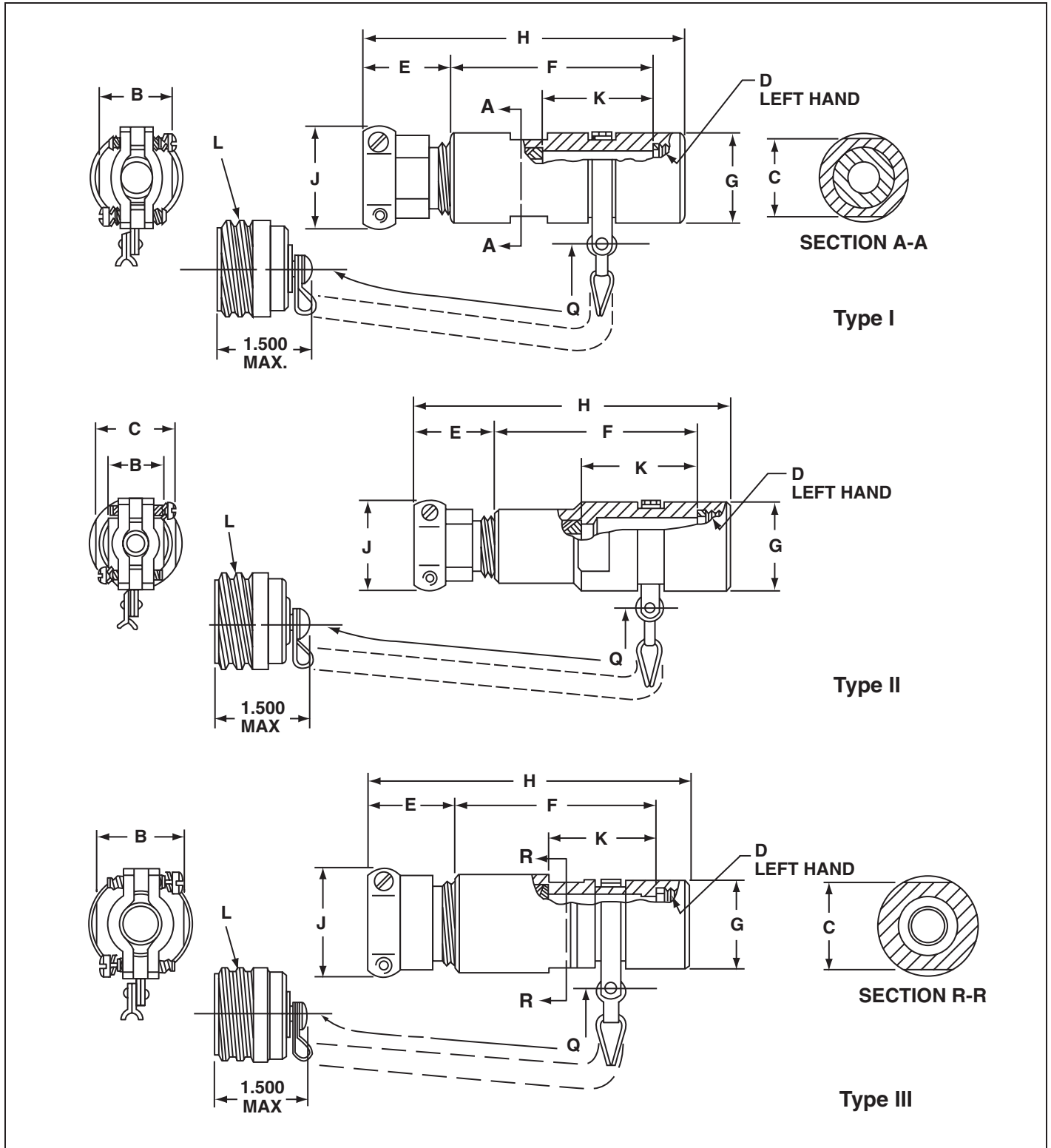

MIL-C-22992, QWLD Accessories

M85049 or 10-522958

cable sealing adapters (plug)

All dimensions for reference only.

| MS Part Number* | Superseded MS Part Number | Proprietary Part Number* | Used With Shell Size | Cable Range | | B +.000 -.010 | C +.000 -.010 | D Thread Class 2B-LH | E Free Length Max | F +.010 -.020 | G Dia +.010 -.020 | H Max | J ±.031 | K +.015 -.025 | L Thread Class 2A (Plated) 0.1P-0.2L Double Stub | Q Approx. | Type |
|-----------------|---------------------------|--------------------------|----------------------|-------------|---------|---------------------|---------------------|----------------------------|-------------------------|---------------------|----------------------------|----------|------------|---------------------|--|--------------|------|
| | | | | Max Dia | Min Dia | | | | | | | | | | | | |
| M85049/4A1A1 | MS17342N1A1 | 10-522958-131 | 12 | .530 | .436 | 1.000 | .812 | .750-20UNEF | 1.062 | 2.719 | .938 | 4.275 | 1.375 | 1.219 | .8750 | 5.000 | III |
| M85049/4A2A1 | MS17342N2A1 | 10-522958-132 | 12 | .500 | .406 | .875 | .938 | .750-20UNEF | .969 | 2.215 | .938 | 3.678 | 1.125 | .871 | .8750 | 5.000 | III |
| M85049/4A3A1 | MS17342N3A1 | 10-522958-133 | 12 | .405 | .311 | 1.000 | .812 | .750-20UNEF | 1.062 | 2.719 | .938 | 4.275 | 1.375 | 1.219 | .8750 | 5.000 | III |
| M85049/3A1A1 | MS17340N1A1 | 10-522958-134 | 12 | .375 | .281 | .750 | .812 | .750-20UNEF | .969 | 1.902 | .938 | 3.365 | 1.062 | .621 | .8750 | 5.000 | I |
| M85049/3A2A1 | MS17340N2A1 | 10-522958-135 | 12 | .281 | .188 | .750 | .812 | .750-20UNEF | .969 | 1.902 | .938 | 3.365 | 1.062 | .621 | .8750 | 5.000 | I |
| M85049/5A1A1 | MS17341N1A1 | 10-522958-136 | 12 | .250 | .156 | .825 | .812 | .750-20UNEF | .906 | 1.782 | .938 | 3.182 | .938 | .563 | .8750 | 5.000 | II |
| M85049/4A5A1 | MS17342N5A1 | 10-522958-151 | 14 | .625 | .531 | 1.062 | 1.125 | .875-20UNEF | 1.062 | 2.933 | 1.062 | 4.489 | 1.562 | 1.371 | 1.0000 | 5.000 | III |
| M85049/4A4A1 | MS17342N4A1 | 10-522958-152 | 14 | .605 | .511 | 1.000 | 1.062 | .875-20UNEF | 1.062 | 2.621 | 1.062 | 4.177 | 1.375 | 1.121 | 1.0000 | 5.000 | III |
| M85049/4A6A1 | MS17342N6A1 | 10-522958-153 | 14 | .530 | .436 | 1.000 | 1.062 | .875-20UNEF | 1.062 | 2.621 | 1.062 | 4.177 | 1.375 | 1.121 | 1.0000 | 5.000 | III |
| M85049/3A3A1 | MS17340N3A1 | 10-522958-154 | 14 | .438 | .344 | .875 | .938 | .875-20UNEF | .969 | 2.215 | 1.062 | 3.678 | 1.125 | .871 | 1.0000 | 5.000 | I |
| M85049/4A7A1 | MS17342N7A1 | 10-522958-155 | 14 | .405 | .311 | 1.000 | 1.062 | .875-20UNEF | 1.062 | 2.621 | 1.062 | 4.177 | 1.375 | 1.121 | 1.0000 | 5.000 | III |
| M85049/3A4A1 | MS17340N4A1 | 10-522958-171 | 16 | .605 | .511 | 1.000 | 1.062 | 1.000-20UNEF | 1.062 | 2.621 | 1.188 | 4.177 | 1.375 | 1.121 | 1.1250 | 5.000 | I |
| M85049/3A5A1 | MS17340N5A1 | 10-522958-172 | 16 | .530 | .436 | 1.000 | 1.062 | 1.000-20UNEF | 1.062 | 2.621 | 1.188 | 4.177 | 1.375 | 1.121 | 1.1250 | 5.000 | I |
| M85049/3A6A1 | MS17340N6A1 | 10-522958-173 | 16 | .405 | .311 | 1.000 | 1.062 | 1.000-20UNEF | 1.062 | 2.621 | 1.188 | 4.177 | 1.375 | 1.121 | 1.1250 | 5.000 | I |
| M85049/4A8A1 | MS17342N8A1 | 10-522958-181 | 18 | .828 | .715 | 1.188 | 1.250 | 1.125-18UNEF | 1.094 | 2.996 | 1.312 | 4.584 | 1.688 | 1.343 | 1.2500 | 5.000 | III |
| M85049/3A8A1 | MS17340N8A1 | 10-522958-182 | 18 | .699 | .605 | 1.062 | 1.125 | 1.125-18UNEF | 1.062 | 2.933 | 1.312 | 4.489 | 1.562 | 1.371 | 1.2500 | 5.000 | I |
| M85049/3A7A1 | MS17340N7A1 | 10-522958-183 | 18 | .625 | .531 | 1.062 | 1.125 | 1.125-18UNEF | 1.062 | 2.933 | 1.312 | 4.489 | 1.562 | 1.371 | 1.2500 | 5.000 | I |
| M85049/5A5A1 | MS17341N5A1 | 10-522958-184 | 18 | .605 | .511 | 1.000 | 1.125 | 1.125-18UNEF | 1.062 | 2.621 | 1.312 | 4.177 | 1.375 | 1.121 | 1.2500 | 5.000 | II |
| M85049/5A6A1 | MS17341N6A1 | 10-522958-185 | 18 | .530 | .436 | 1.000 | 1.125 | 1.125-18UNEF | 1.062 | 2.621 | 1.312 | 4.177 | 1.375 | 1.121 | 1.2500 | 5.000 | II |
| M85049/3A9A1 | MS17340N9A1 | 10-522958-186 | 18 | .500 | .406 | 1.062 | 1.125 | 1.125-18UNEF | 1.062 | 2.933 | 1.312 | 4.489 | 1.562 | 1.371 | 1.2500 | 5.000 | I |
| M85049/3A10A1 | MS17340N10A1 | 10-522958-187 | 18 | .455 | .361 | 1.062 | 1.125 | 1.125-18UNEF | 1.062 | 2.933 | 1.312 | 4.489 | 1.562 | 1.371 | 1.2500 | 5.000 | I |
| M85049/5A2A1 | MS17341N2A1 | 10-522958-188 | 18 | .375 | .281 | .750 | 1.125 | 1.125-18UNEF | .969 | 2.438 | 1.312 | 3.901 | 1.062 | 1.157 | 1.2500 | 5.000 | II |
| M85049/5A3A1 | MS17341N3A1 | 10-522958-189 | 18 | .375 | .281 | .875 | 1.125 | 1.125-18UNEF | .969 | 2.469 | 1.312 | 3.932 | 1.125 | 1.125 | 1.2500 | 5.000 | II |
| M85049/5A4A1 | MS17341N4A1 | 10-522958-190 | 18 | .281 | .188 | .750 | 1.125 | 1.125-18UNEF | .969 | 2.438 | 1.312 | 3.901 | 1.062 | 1.157 | 1.2500 | 5.000 | II |
| M85049/4A12A1 | MS17342N12A1 | 10-522958-201 | 20 | 1.055 | .930 | 1.546 | 1.375 | 1.250-18UNEF | 1.281 | 3.121 | 1.438 | 4.896 | 2.125 | 1.371 | 1.3750 | 5.000 | III |
| M85049/4A10A1 | MS17342N10A1 | 10-522958-202 | 20 | 1.000 | .875 | 1.546 | 1.375 | 1.250-18UNEF | 1.281 | 3.121 | 1.438 | 4.896 | 2.125 | 1.371 | 1.3750 | 5.000 | III |
| M85049/4A11A1 | MS17342N11A1 | 10-522958-203 | 20 | .900 | .787 | 1.312 | 1.375 | 1.250-18UNEF | 1.094 | 3.059 | 1.438 | 4.647 | 1.812 | 1.371 | 1.3750 | 5.000 | III |
| M85049/3A11A1 | MS17340N11A1 | 10-522958-204 | 20 | .828 | .715 | 1.188 | 1.250 | 1.250-18UNEF | 1.125 | 2.996 | 1.438 | 4.615 | 1.688 | 1.371 | 1.3750 | 5.000 | I |
| M85049/4A9A1 | MS17342N9A1 | 10-522958-205 | 20 | .750 | .637 | 1.312 | 1.375 | 1.250-18UNEF | 1.094 | 3.059 | 1.438 | 4.647 | 1.812 | 1.371 | 1.3750 | 5.000 | III |
| M85049/5A7A1 | MS17341N7A1 | 10-522958-206 | 20 | .699 | .605 | 1.062 | 1.250 | 1.250-18UNEF | 1.062 | 2.933 | 1.438 | 4.489 | 1.562 | 1.371 | 1.3750 | 5.000 | II |
| M85049/5A9A1 | MS17341N9A1 | 10-522958-207 | 20 | .605 | .511 | 1.000 | 1.250 | 1.250-18UNEF | 1.062 | 2.750 | 1.438 | 4.308 | 1.375 | 1.250 | 1.3750 | 5.000 | II |
| M85049/3A12A1 | MS17340N12A1 | 10-522958-208 | 20 | .562 | .449 | 1.188 | 1.250 | 1.250-18UNEF | 1.125 | 2.996 | 1.438 | 4.615 | 1.688 | 1.371 | 1.3750 | 5.000 | I |
| M85049/5A8A1 | MS17341N8A1 | 10-522958-209 | 20 | .455 | .361 | 1.062 | 1.250 | 1.250-18UNEF | 1.062 | 2.933 | 1.438 | 4.489 | 1.562 | 1.371 | 1.3750 | 5.000 | II |
| M85049/4A14A1 | MS17342N14A1 | 10-522958-221 | 22 | 1.109 | .984 | 1.546 | 1.625 | 1.375-18UNEF | 1.281 | 3.121 | 1.562 | 4.896 | 2.125 | 1.371 | 1.5000 | 6.000 | III |
| M85049/4A13A1 | MS17342N13A1 | 10-522958-222 | 22 | 1.000 | .875 | 1.546 | 1.625 | 1.375-18UNEF | 1.281 | 3.121 | 1.562 | 4.896 | 2.125 | 1.371 | 1.5000 | 6.000 | III |
| M85049/3A14A1 | MS17340N14A1 | 10-522958-223 | 22 | .900 | .787 | 1.312 | 1.375 | 1.375-18UNEF | 1.094 | 3.059 | 1.562 | 4.647 | 1.812 | 1.371 | 1.5000 | 6.000 | I |
| M85049/5A14A1 | MS17341N14A1 | 10-522958-224 | 22 | .828 | .715 | 1.188 | 1.406 | 1.375-18UNEF | 1.094 | 2.996 | 1.562 | 4.306 | 1.375 | 1.250 | 1.5000 | 6.000 | II |
| M85049/3A15A1 | MS17340N15A1 | 10-522958-225 | 22 | .805 | .692 | 1.312 | 1.375 | 1.375-18UNEF | 1.094 | 3.059 | 1.562 | 4.647 | 1.812 | 1.371 | 1.5000 | 6.000 | I |
| M85049/3A13A1 | MS17340N13A1 | 10-522958-226 | 22 | .750 | .637 | 1.312 | 1.375 | 1.375-18UNEF | 1.094 | 3.059 | 1.562 | 4.647 | 1.812 | 1.371 | 1.5000 | 6.000 | I |
| M85049/5A10A1 | MS17341N10A1 | 10-522958-227 | 22 | .562 | .449 | 1.188 | 1.406 | 1.375-18UNEF | 1.094 | 3.059 | 1.562 | 4.647 | 1.812 | 1.371 | 1.5000 | 6.000 | II |
| M85049/5A11A1 | MS17341N11A1 | 10-522958-228 | 22 | .405 | .311 | 1.000 | 1.375 | 1.375-18UNEF | 1.062 | 2.750 | 1.562 | 4.306 | 1.375 | 1.250 | 1.5000 | 6.000 | II |

* Ordering procedure: Locate shell size needed (Column 4); select cable diameter range to be accommodated within the shell size (column 5); order by either MS part number (column 1) or Proprietary part number (column 3).

MS numbers shown are non-conductive finish. To order conductive finish, substitute "W" for "A" in the part number listed.

10- numbers shown are non-conductive finish. To order conductive finish, substitute prefix 88-.

MIL-C-22992, QWLD Accessories

M85049 or 10-522958

cable sealing adapters (plug)

All dimensions for reference only.

| MS Part Number* | Superseded MS Part Number | Proprietary Part Number* | Used With Shell Size | Cable Range | | B +0.00 -0.10 | C +0.00 -0.10 | D Thread Class 2B-LH | E Free Length Max | F +0.10 -0.20 | G Dia +0.10 -0.20 | H Max | J ±.031 | K +0.015 -0.025 | L Thread Class 2A (Plated) 0.1P-0.2L Double Stub | Q Approx. | Type |
|-----------------|---------------------------|--------------------------|----------------------|-------------|---------|---------------------|---------------------|----------------------------|----------------------------|---------------------|----------------------------|----------|------------|-----------------------|---|--------------|------|
| | | | | Max Dia | Min Dia | | | | | | | | | | | | |
| M85049/4A18A1 | MS17342N18A1 | 10-522958-241 | 24 | 1.375 | 1.250 | 2.000 | 1.875 | 1.625-18UNEF | 1.281 | 3.184 | 1.812 | 4.959 | 2.625 | 1.309 | 1.7500 | 6.000 | III |
| M85049/4A16A1 | MS17342N16A1 | 10-522958-242 | 24 | 1.310 | 1.185 | 1.780 | 1.875 | 1.625-18UNEF | 1.281 | 3.184 | 1.812 | 4.959 | 2.469 | 1.372 | 1.7500 | 6.000 | III |
| M85049/4A17A1 | MS17342N17A1 | 10-522958-243 | 24 | 1.230 | 1.105 | 1.780 | 1.875 | 1.625-18UNEF | 1.281 | 3.184 | 1.812 | 4.959 | 2.469 | 1.372 | 1.7500 | 6.000 | III |
| M85049/4A15A1 | MS17342N15A1 | 10-522958-244 | 24 | 1.180 | 1.055 | 1.780 | 1.875 | 1.625-18UNEF | 1.281 | 3.184 | 1.812 | 4.959 | 2.469 | 1.372 | 1.7500 | 6.000 | III |
| M85049/3A18A1 | MS17340N18A1 | 10-522958-245 | 24 | 1.109 | .984 | 1.546 | 1.625 | 1.625-18UNEF | 1.281 | 3.121 | 1.812 | 4.896 | 2.125 | 1.371 | 1.7500 | 6.000 | I |
| M85049/3A16A1 | MS17340N16A1 | 10-522958-246 | 24 | 1.055 | .930 | 1.546 | 1.625 | 1.625-18UNEF | 1.281 | 3.121 | 1.812 | 4.896 | 2.125 | 1.371 | 1.7500 | 6.000 | I |
| M85049/3A17A1 | MS17340N17A1 | 10-522958-247 | 24 | 1.000 | .675 | 1.546 | 1.625 | 1.625-18UNEF | 1.281 | 3.121 | 1.812 | 4.896 | 2.125 | 1.371 | 1.7500 | 6.000 | I |
| M85049/5A16A1 | MS17341N16A1 | 10-522958-248 | 24 | .970 | .857 | 1.312 | 1.625 | 1.625-18UNEF | 1.094 | 3.059 | 1.812 | 4.647 | 1.812 | 1.371 | 1.7500 | 6.000 | II |
| M85049/5A13A1 | MS17341N13A1 | 10-522958-249 | 24 | .900 | .787 | 1.312 | 1.625 | 1.625-18UNEF | 1.094 | 3.059 | 1.812 | 4.647 | 1.812 | 1.371 | 1.7500 | 6.000 | II |
| M85049/5A19A1 | MS17340N19A1 | 10-522958-250 | 24 | .880 | .755 | 1.546 | 1.625 | 1.625-18UNEF | 1.281 | 3.121 | 1.812 | 4.896 | 2.125 | 1.371 | 1.7500 | 6.000 | I |
| M85049/5A17A1 | MS17341N17A1 | 10-522958-251 | 24 | .828 | .715 | 1.188 | 1.625 | 1.625-18UNEF | 1.094 | 2.954 | 1.812 | 4.542 | 1.688 | 1.301 | 1.7500 | 6.000 | II |
| M85049/5A18A1 | MS17341N18A1 | 10-522958-252 | 24 | .805 | .692 | 1.312 | 1.625 | 1.625-18UNEF | 1.094 | 3.059 | 1.812 | 4.647 | 1.812 | 1.371 | 1.7500 | 6.000 | II |
| M85049/5A15A1 | MS17341N15A1 | 10-522958-253 | 24 | .750 | .637 | 1.312 | 1.625 | 1.625-18UNEF | 1.094 | 3.059 | 1.812 | 4.647 | 1.812 | 1.371 | 1.7500 | 6.000 | II |
| M85049/5A14A1 | MS17341N14A1 | 10-522958-254 | 24 | .630 | .517 | 1.312 | 1.625 | 1.625-18UNEF | 1.094 | 3.059 | 1.812 | 4.647 | 1.812 | 1.371 | 1.7500 | 6.000 | II |
| M85049/4A20A1 | MS17342N20A1 | 10-522958-281 | 28 | 1.531 | 1.406 | 2.000 | 2.062 | 1.875-16UN | 1.281 | 3.246 | 2.062 | 5.021 | 2.625 | 1.371 | 2.000 | 6.000 | III |
| M85049/4A19A1 | MS17342N19A1 | 10-522958-282 | 28 | 1.445 | 1.320 | 2.000 | 2.062 | 1.875-16UN | 1.281 | 3.246 | 2.062 | 5.021 | 2.625 | 1.371 | 2.000 | 6.000 | III |
| M85049/4A21A1 | MS17342N21A1 | 10-522958-283 | 28 | 1.375 | 1.250 | 2.000 | 2.062 | 1.875-16UN | 1.281 | 3.246 | 2.062 | 5.021 | 2.625 | 1.371 | 2.000 | 6.000 | III |
| M85049/4A22A1 | MS17340N22A1 | 10-522958-284 | 28 | 1.310 | 1.185 | 1.780 | 1.875 | 1.875-16UN | 1.281 | 3.184 | 2.062 | 4.959 | 2.469 | 1.372 | 2.000 | 6.000 | I |
| M85049/3A21A1 | MS17340N21A1 | 10-522958-285 | 28 | 1.230 | 1.105 | 1.780 | 1.875 | 1.875-16UN | 1.281 | 3.184 | 2.062 | 4.959 | 2.469 | 1.372 | 2.000 | 6.000 | I |
| M85049/3A20A1 | MS17340N20A1 | 10-522958-286 | 28 | 1.180 | 1.055 | 1.780 | 1.875 | 1.875-16UN | 1.281 | 3.184 | 2.062 | 4.959 | 2.469 | 1.372 | 2.000 | 6.000 | I |
| M85049/5A20A1 | MS17341N20A1 | 10-522958-287 | 28 | 1.109 | .984 | 1.546 | 1.875 | 1.875-16UN | 1.281 | 3.121 | 2.062 | 4.896 | 2.125 | 1.371 | 2.000 | 6.000 | II |
| M85049/5A24A1 | MS17341N24A1 | 10-522958-288 | 28 | 1.100 | .875 | 1.546 | 1.875 | 1.875-16UN | 1.281 | 3.121 | 2.062 | 4.896 | 2.125 | 1.371 | 2.000 | 6.000 | II |
| M85049/5A23A1 | MS17341N23A1 | 10-522958-289 | 28 | .970 | .857 | 1.312 | 1.875 | 1.875-16UN | 1.094 | 3.059 | 2.062 | 4.647 | 1.812 | 1.371 | 2.000 | 6.000 | II |
| M85049/5A19A1 | MS17341N19A1 | 10-522958-290 | 28 | .880 | .755 | 1.546 | 1.875 | 1.875-16UN | 1.281 | 3.121 | 2.062 | 4.896 | 2.125 | 1.371 | 2.000 | 6.000 | II |
| M85049/5A21A1 | MS17341N21A1 | 10-522958-291 | 28 | .750 | .637 | 1.312 | 1.875 | 1.875-16UN | 1.094 | 3.059 | 2.062 | 4.647 | 1.812 | 1.371 | 2.000 | 6.000 | II |
| M85049/5A26A1 | MS17341N26A1 | 10-522958-292 | 28 | .680 | .567 | 1.312 | 1.875 | 1.875-16UN | 1.094 | 3.059 | 2.062 | 4.647 | 1.812 | 1.371 | 2.000 | 6.000 | II |
| M85049/5A25A1 | MS17341N25A1 | 10-522958-293 | 28 | .530 | .436 | 1.000 | 1.812 | 1.875-16UN | 1.062 | 2.875 | 2.062 | 4.431 | 1.375 | 1.375 | 2.000 | 6.000 | II |
| M85049/5A22A1 | MS17341N22A1 | 10-522958-294 | 28 | .375 | .281 | .875 | 1.875 | 1.875-16UN | .969 | 2.766 | 2.062 | 4.229 | 1.125 | 1.422 | 2.000 | 6.000 | II |
| M85049/4A23A1 | MS17342N23A1 | 10-522958-321 | 32 | 1.828 | 1.700 | 2.438 | 2.312 | 2.0625-16UN | 1.391 | 3.500 | 2.312 | 5.385 | 3.171 | 1.375 | 2.2500 | 6.000 | III |
| M85049/4A25A1 | MS17342N25A1 | 10-522958-322 | 32 | 1.730 | 1.605 | 2.438 | 2.312 | 2.0625-16UN | 1.391 | 3.500 | 2.312 | 5.385 | 3.171 | 1.375 | 2.2500 | 6.000 | III |
| M85049/4A22A1 | MS17342N22A1 | 10-522958-323 | 32 | 1.656 | 1.531 | 2.250 | 2.312 | 2.0625-16UN | 1.281 | 3.308 | 2.312 | 5.083 | 2.953 | 1.370 | 2.2500 | 6.000 | III |
| M85049/4A24A1 | MS17342N24A1 | 10-522958-324 | 32 | 1.562 | 1.437 | 2.250 | 2.312 | 2.0625-16UN | 1.281 | 3.308 | 2.312 | 5.083 | 2.953 | 1.370 | 2.2500 | 6.000 | III |
| M85049/3A24A1 | MS17340N24A1 | 10-522958-325 | 32 | 1.531 | 1.406 | 2.000 | 2.062 | 2.0625-16UN | 1.281 | 3.246 | 2.312 | 5.021 | 2.625 | 1.371 | 2.2500 | 6.000 | I |
| M85049/3A23A1 | MS17340N23A1 | 10-522958-326 | 32 | 1.445 | 1.320 | 2.000 | 2.062 | 2.0625-16UN | 1.281 | 3.246 | 2.312 | 5.021 | 2.625 | 1.371 | 2.2500 | 6.000 | I |
| M85049/3A25A1 | MS17340N25A1 | 10-522958-327 | 32 | 1.375 | 1.250 | 2.000 | 2.062 | 2.0625-16UN | 1.281 | 3.246 | 2.312 | 5.021 | 2.625 | 1.371 | 2.2500 | 6.000 | I |
| M85049/5A28A1 | MS17341N28A1 | 10-522958-328 | 32 | 1.230 | 1.150 | 1.780 | 2.062 | 2.0625-16UN | 1.281 | 3.184 | 2.312 | 4.959 | 2.469 | 1.372 | 2.2500 | 6.000 | II |
| M85049/5A35A1 | MS17341N35A1 | 10-522958-329 | 32 | 1.130 | 1.005 | 1.780 | 2.062 | 2.0625-16UN | 1.281 | 3.184 | 2.312 | 4.959 | 2.469 | 1.372 | 2.2500 | 6.000 | II |
| M85049/5A31A1 | MS17341N31A1 | 10-522958-330 | 32 | 1.109 | .984 | 1.546 | 2.062 | 2.0625-16UN | 1.281 | 3.121 | 2.312 | 4.896 | 2.125 | 1.371 | 2.2500 | 6.000 | II |
| M85049/5A27A1 | MS17341N27A1 | 10-522958-331 | 32 | 1.055 | .930 | 1.546 | 2.062 | 2.0625-16UN | 1.281 | 3.121 | 2.312 | 4.896 | 2.125 | 1.371 | 2.2500 | 6.000 | II |
| M85049/5A32A1 | MS17341N32A1 | 10-522958-332 | 32 | .970 | .857 | 1.312 | 2.062 | 2.0625-16UN | 1.094 | 3.059 | 2.312 | 4.647 | 1.812 | 1.371 | 2.2500 | 6.000 | II |
| M85049/5A30A1 | MS17341N30A1 | 10-522958-333 | 32 | .880 | .755 | 1.546 | 2.062 | 2.0625-16UN | 1.281 | 3.121 | 2.312 | 4.896 | 2.125 | 1.371 | 2.2500 | 6.000 | II |
| M85049/5A29A1 | MS17341N29A1 | 10-522958-334 | 32 | .750 | .637 | 1.312 | 2.062 | 2.0625-16UN | 1.094 | 3.059 | 2.312 | 4.647 | 1.812 | 1.371 | 2.2500 | 6.000 | II |

* Ordering procedure: Locate shell size needed (Column 4); select cable diameter range to be accommodated within the shell size (column 5); order by either MS part number (column 1) or Proprietary part number (column 3).

MS numbers shown are non-conductive finish. To order conductive finish, substitute "W" for "A" in the part number listed.

10- numbers shown are non-conductive finish. To order conductive finish, substitute prefix 88-.

MIL-C-22992, QWLD Accessories

M85049 or 10-522958

cable sealing adapters (plug)

All dimensions for reference only.

| MS Part Number* | Superseded MS Part Number | Proprietary Part Number* | Used With Shell Size | Cable Range | | B +.000 -.010 | C +.000 -.010 | D Thread Class 2B-LH | E Free Length Max | F +.010 -.020 | G Dia +.010 -.020 | H Max | J ±.031 | K +.015 -.025 | L Thread Class 2A (Plated) 0.1P-0.2L Double Stub | Q Approx. | Type |
|-----------------|---------------------------|--------------------------|----------------------|-------------|---------|---------------------|---------------------|----------------------------|-------------------------|---------------------|----------------------------|----------|------------|---------------------|--|--------------|------|
| | | | | Max Dia | Min Dia | | | | | | | | | | | | |
| M85049/5A34A1 | MS17341N34A1 | 10-522958-335 | 32 | .530 | .436 | 1.000 | 2.000 | 2.0625-16UN | 1.062 | 2.875 | 2.312 | 4.431 | 1.375 | 1.375 | 2.2500 | 6.000 | II |
| M85049/5A33A1 | MS17341N33A1 | 10-522958-336 | 32 | .375 | .281 | .875 | 2.062 | 2.0625-16UN | .969 | 2.813 | 2.312 | 4.276 | 1.125 | 1.469 | 2.2500 | 6.000 | II |
| M85049/4A30A1 | MS17342N30A1 | 10-522958-361 | 36 | 2.062 | 1.917 | 2.750 | 2.500 | 2.3125-16UN | 1.391 | 3.500 | 2.562 | 5.385 | 3.375 | 1.375 | 2.5000 | 6.000 | III |
| M85049/4A29A1 | MS17342N29A1 | 10-522958-362 | 36 | 1.984 | 1.859 | 2.438 | 2.500 | 2.3125-16UN | 1.391 | 3.469 | 2.562 | 5.354 | 3.171 | 1.344 | 2.5000 | 6.000 | III |
| M85049/4A26A1 | MS17342N26A1 | 10-522958-363 | 36 | 1.900 | 1.775 | 2.438 | 2.500 | 2.3125-16UN | 1.391 | 3.469 | 2.562 | 5.354 | 3.171 | 1.344 | 2.5000 | 6.000 | III |
| M85049/4A28A1 | MS17342N28A1 | 10-522958-364 | 36 | 1.825 | 1.799 | 2.438 | 2.500 | 2.3125-16UN | 1.391 | 3.469 | 2.562 | 5.354 | 3.171 | 1.344 | 2.5000 | 6.000 | III |
| M85049/4A27A1 | MS17342N27A1 | 10-522958-365 | 36 | 1.730 | 1.605 | 2.438 | 2.500 | 2.3125-16UN | 1.391 | 3.469 | 2.562 | 5.354 | 3.171 | 1.344 | 2.5000 | 6.000 | III |
| M85049/3A26A1 | MS17340N26A1 | 10-522958-366 | 36 | 1.656 | 1.531 | 2.250 | 2.312 | 2.3125-16UN | 1.281 | 3.308 | 2.562 | 5.083 | 2.953 | 1.370 | 2.5000 | 6.000 | I |
| M85049/3A27A1 | MS17340N27A1 | 10-522958-367 | 36 | 1.562 | 1.437 | 2.250 | 2.312 | 2.3125-16UN | 1.281 | 3.308 | 2.562 | 5.083 | 2.953 | 1.370 | 2.5000 | 6.000 | I |
| M85049/5A40A1 | MS17341N40A1 | 10-522958-368 | 36 | 1.445 | 1.320 | 2.000 | 2.312 | 2.3125-16UN | 1.281 | 3.246 | 2.562 | 5.021 | 2.625 | 1.371 | 2.5000 | 6.000 | II |
| M85049/5A38A1 | MS17341N38A1 | 10-522958-369 | 36 | 1.375 | 1.250 | 2.000 | 2.312 | 2.3125-16UN | 1.281 | 3.246 | 2.562 | 5.021 | 2.625 | 1.371 | 2.5000 | 6.000 | II |
| M85049/5A36A1 | MS17341N36A1 | 10-522958-370 | 36 | 1.310 | 1.185 | 1.780 | 2.312 | 2.3125-16UN | 1.281 | 3.184 | 2.562 | 4.959 | 2.469 | 1.372 | 2.5000 | 6.000 | II |
| M85049/5A42A1 | MS17341N42A1 | 10-522958-371 | 36 | 1.230 | 1.105 | 1.780 | 2.312 | 2.3125-16UN | 1.281 | 3.184 | 2.562 | 4.959 | 2.469 | 1.372 | 2.5000 | 6.000 | II |
| M85049/5A39A1 | MS17341N39A1 | 10-522958-372 | 36 | 1.180 | 1.055 | 1.780 | 2.312 | 2.3125-16UN | 1.281 | 3.184 | 2.562 | 4.959 | 2.469 | 1.372 | 2.5000 | 6.000 | II |
| M85049/5A37A1 | MS17341N37A1 | 10-522958-373 | 36 | 1.109 | .984 | 1.546 | 2.312 | 2.3125-16UN | 1.281 | 3.121 | 2.562 | 4.896 | 2.125 | 1.371 | 2.5000 | 6.000 | II |
| M85049/5A41A1 | MS17341N41A1 | 10-522958-374 | 36 | .970 | .857 | 1.312 | 2.250 | 2.3125-16UN | 1.094 | 3.063 | 2.562 | 4.651 | 1.812 | 1.375 | 2.5000 | 6.000 | II |
| M85049/4A31A1 | MS17342N31A1 | 10-522958-401 | 40 | 2.375 | 2.230 | 3.000 | 2.812 | 2.625-16UN | 1.391 | 3.609 | 2.875 | 5.682 | 3.625 | 1.421 | 2.7500 | 6.000 | III |
| M85049/4A32A1 | MS17342N32A1 | 10-522958-402 | 40 | 2.250 | 2.105 | 2.875 | 2.625 | 2.625-16UN | 1.391 | 3.609 | 2.875 | 5.682 | 3.500 | 1.421 | 2.7500 | 6.000 | III |
| M85049/4A33A1 | MS17342N33A1 | 10-522958-403 | 40 | 2.145 | 2.000 | 2.750 | 2.625 | 2.625-16UN | 1.391 | 3.547 | 2.875 | 5.620 | 3.375 | 1.422 | 2.7500 | 6.000 | III |
| M85049/4A34A1 | MS17342N34A1 | 10-522958-404 | 40 | 2.062 | 1.917 | 2.750 | 2.625 | 2.625-16UN | 1.391 | 3.547 | 2.875 | 5.620 | 3.375 | 1.422 | 2.7500 | 6.000 | III |
| M85049/5A43A1 | MS17341N43A1 | 10-522958-405 | 40 | 1.940 | 1.815 | 2.438 | 2.750 | 2.625-16UN | 1.391 | 4.281 | 2.875 | 6.354 | 3.171 | 2.156 | 2.7500 | 6.000 | II |
| M85049/5A44A1 | MS17341N44A1 | 10-522958-406 | 40 | 1.825 | 1.700 | 2.438 | 2.750 | 2.625-16UN | 1.391 | 4.281 | 2.875 | 6.354 | 3.171 | 2.156 | 2.7500 | 6.000 | II |
| M85049/5A45A1 | MS17341N45A1 | 10-522958-407 | 40 | 1.730 | 1.605 | 2.438 | 2.750 | 2.625-16UN | 1.391 | 4.281 | 2.875 | 6.354 | 3.171 | 2.156 | 2.7500 | 6.000 | II |
| M85049/5A46A1 | MS17341N46A1 | 10-522958-408 | 40 | 1.656 | 1.531 | 2.250 | 2.750 | 2.625-16UN | 1.281 | 4.094 | 2.875 | 6.037 | 2.953 | 2.156 | 2.7500 | 6.000 | II |

* Ordering procedure: Locate shell size needed (Column 4); select cable diameter range to be accommodated within the shell size (column 5); order by either MS part number (column 1) or Proprietary part number (column 3).

MS numbers shown are non-conductive finish. To order conductive finish, substitute "W" for "A" in the part number listed.

10- numbers shown are non-conductive finish. To order conductive finish, substitute prefix 88-.

MIL-C-22992, QWLD Accessories M85049 or 10-524959 cable sealing adapters (receptacle)

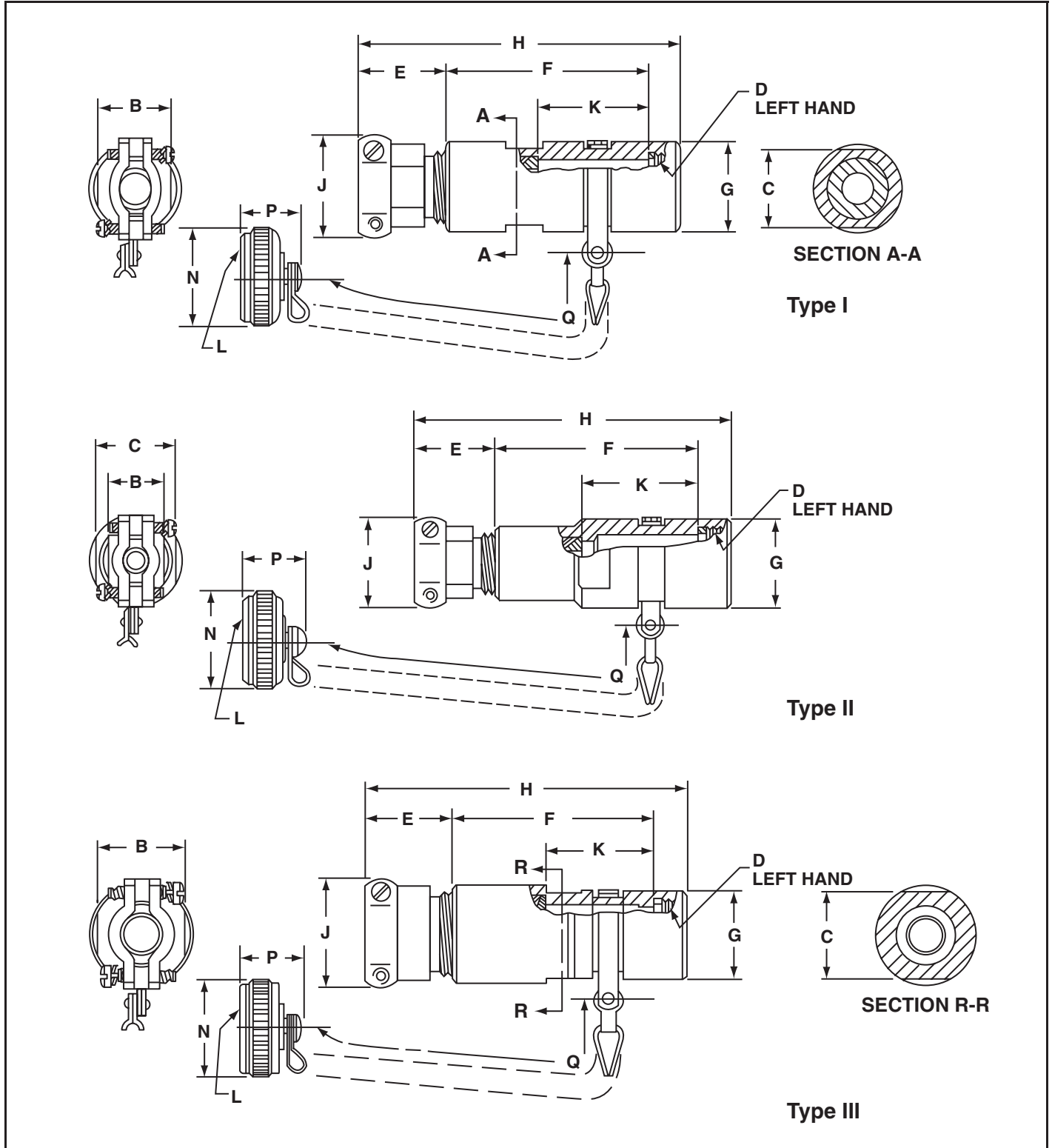

MIL-C-22992, QWLD Accessories

M85049 or 10-524959

cable sealing adapters (receptacle)

All dimensions for reference only.

| MS Part Number* | Superseded MS Part Number | Proprietary Part Number* | Used With Shell Size | Cable Range | | B +.000 -.010 | C +.000 -.010 | D Thread Class 2B-LH | E Free Length Max | F +.010 -.020 | G Dia +.010 -.020 | H Max | J ±.031 | K +.015 -.025 | L Thread Class 2A 0.1P-0.2L Double Stub | N Dia Maz | P Max | Q Approx. | Type |
|-----------------|---------------------------|--------------------------|----------------------|-------------|---------|---------------------|---------------------|----------------------------|----------------------------|---------------------|----------------------------|----------|------------|---------------------|---|-----------------|----------|--------------|------|
| | | | | Max Dia | Min Dia | | | | | | | | | | | | | | |
| M85049/4A1B1 | MS17342N1B1 | 10-524959-131 | 12 | .530 | .436 | 1.000 | .812 | .750-20UNEF | 1.062 | 2.719 | .938 | 4.275 | 1.375 | 1.219 | .8750 | 2.719 | .765 | 5.000 | III |
| M85049/4A2B1 | MS17342N2B1 | 10-524959-132 | 12 | .500 | .406 | .875 | .938 | .750-20UNEF | .969 | 2.215 | .938 | 3.678 | 1.125 | .871 | .8750 | 2.719 | .765 | 5.000 | III |
| M85049/4A3B1 | MS17342N3B1 | 10-524959-133 | 12 | .405 | .311 | 1.000 | .812 | .750-20UNEF | 1.062 | 2.719 | .938 | 4.275 | 1.375 | 1.219 | .8750 | 1.094 | .765 | 5.000 | III |
| M85049/3A1B1 | MS17340N1B1 | 10-524959-134 | 12 | .375 | .281 | .750 | .812 | .750-20UNEF | .969 | 1.902 | .938 | 3.365 | 1.062 | .621 | .8750 | 1.094 | .765 | 5.000 | I |
| M85049/3A2B1 | MS17340N2B1 | 10-524959-135 | 12 | .281 | .188 | .750 | .812 | .750-20UNEF | .969 | 1.902 | .938 | 3.365 | 1.062 | .621 | .8750 | 1.094 | .765 | 5.000 | I |
| M85049/5A1B1 | MS17341N1B1 | 10-524959-136 | 12 | .250 | .156 | .625 | .812 | .750-20UNEF | .906 | 1.782 | .938 | 3.182 | .938 | .563 | .8750 | 1.094 | .765 | 5.000 | II |
| M85049/4A5B1 | MS17342N5B1 | 10-524959-151 | 14 | .625 | .531 | 1.062 | 1.125 | .875-20UNEF | 1.062 | 2.933 | 1.062 | 4.489 | 1.562 | 1.371 | 1.0000 | 1.094 | .765 | 5.000 | III |
| M85049/4A4B1 | MS17342N4B1 | 10-524959-152 | 14 | .605 | .511 | 1.000 | 1.062 | .875-20UNEF | 1.062 | 2.621 | 1.062 | 4.177 | 1.375 | 1.121 | 1.0000 | 1.094 | .765 | 5.000 | III |
| M85049/4A6B1 | MS17342N6B1 | 10-524959-153 | 14 | .530 | .436 | 1.000 | 1.062 | .875-20UNEF | 1.062 | 2.621 | 1.062 | 4.177 | 1.375 | 1.121 | 1.0000 | 1.094 | .765 | 5.000 | III |
| M85049/3A3B1 | MS17340N3B1 | 10-524959-154 | 14 | .438 | .344 | .875 | .938 | .875-20UNEF | .969 | 2.215 | 1.062 | 3.678 | 1.125 | .871 | 1.0000 | 1.219 | .765 | 5.000 | I |
| M85049/4A7B1 | MS17342N7B1 | 10-524959-155 | 14 | .405 | .311 | 1.000 | 1.062 | .875-20UNEF | 1.062 | 2.621 | 1.188 | 4.177 | 1.375 | 1.121 | 1.0000 | 1.344 | .765 | 5.000 | III |
| M85049/3A4B1 | MS17340N4B1 | 10-524959-171 | 16 | .605 | .511 | 1.000 | 1.062 | 1.000-20UNEF | 1.062 | 2.621 | 1.188 | 4.177 | 1.375 | 1.121 | 1.1250 | 1.344 | .980 | 5.000 | I |
| M85049/3A5B1 | MS17340N5B1 | 10-524959-172 | 16 | .530 | .436 | 1.000 | 1.062 | 1.000-20UNEF | 1.062 | 2.621 | 1.188 | 4.177 | 1.375 | 1.121 | 1.1250 | 1.344 | .980 | 5.000 | I |
| M85049/3A6B1 | MS17340N6B1 | 10-524959-173 | 16 | .405 | .311 | 1.000 | 1.062 | 1.000-20UNEF | 1.062 | 2.621 | 1.312 | 4.177 | 1.375 | 1.121 | 1.1250 | 1.344 | .980 | 5.000 | I |
| M85049/4A8B1 | MS17342N8B1 | 10-524959-181 | 18 | .828 | .715 | 1.188 | 1.250 | 1.125-18UNEF | 1.094 | 2.996 | 1.312 | 4.584 | 1.688 | 1.343 | 1.2500 | 1.469 | .980 | 5.000 | III |
| M85049/3A8B1 | MS17340N8B1 | 10-524959-182 | 18 | .699 | .605 | 1.062 | 1.125 | 1.125-18UNEF | 1.062 | 2.933 | 1.312 | 4.489 | 1.562 | 1.371 | 1.2500 | 1.469 | .980 | 5.000 | I |
| M85049/3A7B1 | MS17340N7B1 | 10-524959-183 | 18 | .625 | .531 | 1.062 | 1.125 | 1.125-18UNEF | 1.062 | 2.933 | 1.312 | 4.489 | 1.562 | 1.371 | 1.2500 | 1.469 | .980 | 5.000 | I |
| M85049/5A5B1 | MS17341N5B1 | 10-524959-184 | 18 | .605 | .511 | 1.000 | 1.125 | 1.125-18UNEF | 1.062 | 2.621 | 1.312 | 4.177 | 1.375 | 1.121 | 1.2500 | 2.719 | .980 | 5.000 | II |
| M85049/5A6B1 | MS17341N6B1 | 10-524959-185 | 18 | .530 | .436 | 1.000 | 1.125 | 1.125-18UNEF | 1.062 | 2.621 | 1.312 | 4.177 | 1.375 | 1.121 | 1.2500 | 2.719 | .980 | 5.000 | II |
| M85049/3A9B1 | MS17340N9B1 | 10-524959-186 | 18 | .500 | .406 | 1.062 | 1.125 | 1.125-18UNEF | 1.062 | 2.933 | 1.312 | 4.489 | 1.562 | 1.371 | 1.2500 | 1.469 | .980 | 5.000 | I |
| M85049/3A10B1 | MS17340N10B1 | 10-524959-187 | 18 | .455 | .361 | 1.062 | 1.125 | 1.125-18UNEF | 1.062 | 2.933 | 1.312 | 4.489 | 1.562 | 1.371 | 1.2500 | 1.469 | .980 | 5.000 | I |
| M85049/5A2B1 | MS17341N2B1 | 10-524959-188 | 18 | .375 | .281 | .750 | 1.125 | 1.125-18UNEF | .969 | 2.438 | 1.312 | 4.901 | 1.062 | 1.157 | 1.2500 | 2.719 | .980 | 5.000 | II |
| M85049/5A3B1 | MS17341N3B1 | 10-524959-189 | 18 | .375 | .281 | .875 | 1.125 | 1.125-18UNEF | .969 | 2.469 | 1.312 | 4.932 | 1.125 | 1.125 | 1.2500 | 2.719 | .980 | 5.000 | II |
| M85049/5A4B1 | MS17341N4B1 | 10-524959-190 | 18 | .281 | .188 | .750 | 1.125 | 1.125-18UNEF | .969 | 2.438 | 1.312 | 4.901 | 1.062 | 1.157 | 1.2500 | 2.719 | .980 | 5.000 | II |
| M85049/4A12B1 | MS17342N12B1 | 10-524959-201 | 20 | 1.055 | .930 | 1.546 | 1.375 | 1.250-18UNEF | 1.281 | 3.121 | 1.438 | 4.896 | 2.125 | 1.371 | 1.3750 | 2.719 | .980 | 5.000 | III |
| M85049/4A10B1 | MS17342N10B1 | 10-524959-202 | 20 | 1.000 | .875 | 1.546 | 1.375 | 1.250-18UNEF | 1.281 | 3.121 | 1.438 | 4.896 | 2.125 | 1.371 | 1.3750 | 2.719 | .980 | 6.000 | III |
| M85049/4A11B1 | MS17342N11B1 | 10-524959-203 | 20 | .900 | .787 | 1.312 | 1.375 | 1.250-18UNEF | 1.094 | 3.059 | 1.438 | 4.647 | 1.812 | 1.371 | 1.3750 | 2.719 | .980 | 5.000 | III |
| M85049/3A11B1 | MS17340N11B1 | 10-524959-204 | 20 | .828 | .715 | 1.188 | 1.250 | 1.250-18UNEF | 1.125 | 2.996 | 1.438 | 4.615 | 1.688 | 1.371 | 1.3750 | 1.562 | .980 | 5.000 | I |
| M85049/4A9B1 | MS17342N9B1 | 10-524959-205 | 20 | .750 | .637 | 1.312 | 1.375 | 1.250-18UNEF | 1.094 | 3.059 | 1.438 | 4.647 | 1.812 | 1.371 | 1.3750 | 2.719 | .980 | 5.000 | III |
| M85049/5A7B1 | MS17341N7B1 | 10-524959-206 | 20 | .699 | .605 | 1.062 | 1.250 | 1.250-18UNEF | 1.062 | 2.933 | 1.438 | 4.489 | 1.562 | 1.250 | 1.3750 | 2.719 | .980 | 5.000 | II |
| M85049/5A9B1 | MS17341N9B1 | 10-524959-207 | 20 | .605 | .511 | 1.000 | 1.250 | 1.250-18UNEF | 1.062 | 2.750 | 1.438 | 4.306 | 1.375 | 1.371 | 1.3750 | 1.562 | .980 | 5.000 | II |
| M85049/3A12B1 | MS17340N12B1 | 10-524959-208 | 20 | .562 | .449 | 1.188 | 1.250 | 1.250-18UNEF | 1.125 | 2.996 | 1.438 | 4.615 | 1.688 | 1.371 | 1.3750 | 1.562 | .980 | 5.000 | I |
| M85049/5A8B1 | MS17341N8B1 | 10-524959-209 | 20 | .455 | .361 | 1.062 | 1.250 | 1.250-18UNEF | 1.062 | 2.933 | 1.438 | 4.489 | 1.562 | 1.371 | 1.3750 | 1.562 | .980 | 5.000 | II |
| M85049/4A14B1 | MS17342N14B1 | 10-524959-221 | 22 | 1.109 | .984 | 1.546 | 1.625 | 1.375-18UNEF | 1.281 | 3.121 | 1.562 | 4.896 | 2.125 | 1.371 | 1.5000 | 1.562 | .980 | 6.000 | III |
| M85049/4A13B1 | MS17342N13B1 | 10-524959-222 | 22 | 1.000 | .875 | 1.546 | 1.625 | 1.375-18UNEF | 1.281 | 3.121 | 1.562 | 4.896 | 2.125 | 1.371 | 1.5000 | 1.562 | .980 | 6.000 | III |
| M85049/3A14B1 | MS17340N14B1 | 10-524959-223 | 22 | .900 | .787 | 1.312 | 1.375 | 1.375-18UNEF | 1.094 | 3.059 | 1.562 | 4.647 | 1.812 | 1.371 | 1.5000 | 1.688 | .980 | 6.000 | I |
| M85049/5A12B1 | MS17341N12B1 | 10-524959-224 | 22 | .828 | .715 | 1.188 | 1.406 | 1.375-18UNEF | 1.094 | 2.996 | 1.562 | 4.306 | 1.375 | 1.250 | 1.5000 | 1.688 | .980 | 6.000 | II |
| M85049/3A15B1 | MS17340N15B1 | 10-524959-225 | 22 | .805 | .692 | 1.312 | 1.375 | 1.375-18UNEF | 1.094 | 3.059 | 1.562 | 4.647 | 1.812 | 1.371 | 1.5000 | 1.688 | .980 | 6.000 | I |
| M85049/3A13B1 | MS17340N13B1 | 10-524959-226 | 22 | .750 | .637 | 1.312 | 1.375 | 1.375-18UNEF | 1.094 | 3.059 | 1.562 | 4.647 | 1.812 | 1.371 | 1.5000 | 1.688 | .980 | 6.000 | I |
| M85049/5A10B1 | MS17341N10B1 | 10-524959-227 | 22 | .562 | .449 | 1.188 | 1.406 | 1.375-18UNEF | 1.094 | 2.996 | 1.562 | 4.584 | 1.688 | 1.343 | 1.5000 | 2.719 | .980 | 6.000 | II |
| M85049/5A11B1 | MS17341N11B1 | 10-524959-228 | 22 | .405 | .311 | 1.000 | 1.375 | 1.375-18UNEF | 1.062 | 2.750 | 1.562 | 4.306 | 1.375 | 1.250 | 1.5000 | 2.719 | .980 | 6.000 | II |

* Ordering procedure: Locate shell size needed (Column 4); select cable diameter range to be accommodated within the shell size (column 5); order by either MS part number (column 1) or Proprietary part number (column 3).

MS numbers shown are non-conductive finish. To order conductive finish, substitute "W" for "A" in the part number listed.

10- numbers shown are non-conductive finish. To order conductive finish, substitute prefix 88-.

MIL-C-22992, QWLD Accessories M85049 or 10-524959 cable sealing adapters (receptacle)

All dimensions for reference only.

| MS Part Number* | Superseded MS Part Number | Proprietary Part Number* | Used With Shell Size | Cable Range | | B + .000 - .010 | C + .000 - .010 | D Thread Class 2B-LH | E Free Length Max | F + .010 - .020 | G Dia + .010 - .020 | H Max | J ± .031 | K + .015 - .025 | L Thread Class 2A 0.1P-0.2L Double Stub | N Dia Max | P Max | Q Approx. | Type |
|-----------------|---------------------------|--------------------------|----------------------|-------------|---------|-----------------------|-----------------------|----------------------------|----------------------------|-----------------------|------------------------------|----------|-------------|-----------------------|---|-----------------|----------|--------------|------|
| | | | | Max Dia | Min Dia | | | | | | | | | | | | | | |
| MS85049/4A18B1 | MS17342N18B1 | 10-524959-241 | 24 | 1.375 | 1.250 | 2.000 | 1.875 | 1.625-18UNEF | 1.281 | 3.184 | 1.812 | 4.959 | 2.625 | 1.309 | 1.7500 | 2.719 | .980 | 6.000 | III |
| MS85049/4A16B1 | MS17342N16B1 | 10-524959-242 | 24 | 1.310 | 1.185 | 1.780 | 1.875 | 1.625-18UNEF | 1.281 | 3.184 | 1.812 | 4.959 | 2.469 | 1.372 | 1.7500 | 2.719 | .980 | 6.000 | III |
| MS85049/4A17B1 | MS17342N17B1 | 10-524959-243 | 24 | 1.230 | 1.105 | 1.780 | 1.875 | 1.625-18UNEF | 1.281 | 3.184 | 1.812 | 4.959 | 2.469 | 1.372 | 1.7500 | 2.719 | .980 | 6.000 | III |
| MS85049/4A15B1 | MS17342N15B1 | 10-524959-244 | 24 | 1.180 | 1.055 | 1.780 | 1.875 | 1.625-18UNEF | 1.281 | 3.184 | 1.812 | 4.959 | 2.469 | 1.372 | 1.7500 | 2.719 | .980 | 6.000 | III |
| MS85049/3A18B1 | MS17340N18B1 | 10-524959-245 | 24 | 1.109 | .984 | 1.546 | 1.625 | 1.625-18UNEF | 1.281 | 3.121 | 1.812 | 4.896 | 2.125 | 1.371 | 1.7500 | 1.938 | .980 | 6.000 | I |
| MS85049/3A16B1 | MS17340N16B1 | 10-524959-246 | 24 | 1.055 | .930 | 1.546 | 1.625 | 1.625-18UNEF | 1.281 | 3.121 | 1.812 | 4.896 | 2.125 | 1.371 | 1.7500 | 1.938 | .980 | 6.000 | I |
| MS85049/3A17B1 | MS17340N17B1 | 10-524959-247 | 24 | 1.000 | .675 | 1.546 | 1.625 | 1.625-18UNEF | 1.281 | 3.121 | 1.812 | 4.896 | 2.125 | 1.371 | 1.7500 | 1.938 | .980 | 6.000 | I |
| MS85049/5A16B1 | MS17341N16B1 | 10-524959-248 | 24 | .970 | .857 | 1.312 | 1.625 | 1.625-18UNEF | 1.094 | 3.059 | 1.812 | 4.647 | 1.812 | 1.371 | 1.7500 | 2.719 | .980 | 6.000 | II |
| MS85049/5A13B1 | MS17341N13B1 | 10-524959-249 | 24 | .900 | .787 | 1.312 | 1.625 | 1.625-18UNEF | 1.094 | 3.059 | 1.812 | 4.647 | 1.812 | 1.371 | 1.7500 | 2.719 | .980 | 6.000 | II |
| MS85049/3A19B1 | MS17340N19B1 | 10-524959-250 | 24 | .880 | .755 | 1.546 | 1.625 | 1.625-18UNEF | 1.281 | 3.121 | 1.812 | 4.896 | 2.125 | 1.371 | 1.7500 | 1.938 | .980 | 6.000 | I |
| MS85049/5A17B1 | MS17341N17B1 | 10-524959-251 | 24 | .828 | .715 | 1.188 | 1.625 | 1.625-18UNEF | 1.094 | 2.954 | 1.812 | 4.542 | 1.688 | 1.301 | 1.7500 | 2.719 | .980 | 6.000 | II |
| MS85049/5A18B1 | MS17341N18B1 | 10-524959-252 | 24 | .805 | .692 | 1.312 | 1.625 | 1.625-18UNEF | 1.094 | 3.059 | 1.812 | 4.647 | 1.812 | 1.371 | 1.7500 | 2.719 | .980 | 6.000 | II |
| MS85049/5A15B1 | MS17341N15B1 | 10-524959-253 | 24 | .750 | .637 | 1.312 | 1.625 | 1.625-18UNEF | 1.094 | 3.059 | 1.812 | 4.647 | 1.812 | 1.371 | 1.7500 | 2.719 | .980 | 6.000 | II |
| MS85049/5A14B1 | MS17341N14B1 | 10-524959-254 | 24 | .630 | .517 | 1.312 | 1.625 | 1.625-18UNEF | 1.094 | 3.059 | 1.812 | 4.647 | 1.812 | 1.371 | 1.7500 | 2.719 | .980 | 6.000 | II |
| MS85049/4A20B1 | MS17342N20B1 | 10-524959-281 | 28 | 1.531 | 1.406 | 2.000 | 2.062 | 1.875-16UN | 1.281 | 3.246 | 2.062 | 5.021 | 2.625 | 1.371 | 2.0000 | 2.719 | .980 | 6.000 | III |
| MS85049/4A19B1 | MS17342N19B1 | 10-524959-282 | 28 | 1.445 | 1.320 | 2.000 | 2.062 | 1.875-16UN | 1.281 | 3.246 | 2.062 | 5.021 | 2.625 | 1.371 | 2.0000 | 2.719 | .980 | 6.000 | III |
| MS85049/4A21B1 | MS17342N21B1 | 10-524959-283 | 28 | 1.375 | 1.250 | 2.000 | 2.062 | 1.875-16UN | 1.281 | 3.246 | 2.062 | 5.021 | 2.625 | 1.371 | 2.0000 | 2.719 | .980 | 6.000 | III |
| MS85049/3A22B1 | MS17340N22B1 | 10-524959-284 | 28 | 1.310 | 1.185 | 1.780 | 1.875 | 1.875-16UN | 1.281 | 3.184 | 2.062 | 4.959 | 2.469 | 1.372 | 2.0000 | 2.219 | .980 | 6.000 | I |
| MS85049/3A21B1 | MS17340N21B1 | 10-524959-285 | 28 | 1.230 | 1.105 | 1.780 | 1.875 | 1.875-16UN | 1.281 | 3.184 | 2.062 | 4.959 | 2.469 | 1.372 | 2.0000 | 2.219 | .980 | 6.000 | I |
| MS85049/3A20B1 | MS17340N20B1 | 10-524959-286 | 28 | 1.180 | 1.055 | 1.780 | 1.875 | 1.875-16UN | 1.281 | 3.184 | 2.062 | 4.959 | 2.469 | 1.372 | 2.0000 | 2.219 | .980 | 6.000 | I |
| MS85049/5A20B1 | MS17341N20B1 | 10-524959-287 | 28 | 1.109 | .984 | 1.546 | 1.875 | 1.875-16UN | 1.281 | 3.121 | 2.062 | 4.896 | 2.125 | 1.371 | 2.0000 | 2.279 | .980 | 6.000 | II |
| MS85049/5A24B1 | MS17341N24B1 | 10-524959-288 | 28 | 1.000 | .875 | 1.546 | 1.875 | 1.875-16UN | 1.281 | 3.121 | 2.062 | 4.896 | 2.125 | 1.371 | 2.0000 | 2.279 | .980 | 6.000 | II |
| MS85049/5A23B1 | MS17341N23B1 | 10-524959-289 | 28 | .970 | .857 | 1.312 | 1.875 | 1.875-16UN | 1.094 | 3.059 | 2.062 | 4.647 | 1.812 | 1.371 | 2.0000 | 2.719 | .980 | 6.000 | II |
| MS85049/5A19B1 | MS17341N19B1 | 10-524959-290 | 28 | .880 | .755 | 1.546 | 1.875 | 1.875-16UN | 1.281 | 3.121 | 2.062 | 4.896 | 2.125 | 1.371 | 2.0000 | 2.719 | .980 | 6.000 | II |
| MS85049/5A19B1 | MS17341N21B1 | 10-524959-291 | 28 | .750 | .637 | 1.312 | 1.875 | 1.875-16UN | 1.094 | 3.059 | 2.062 | 4.647 | 1.812 | 1.371 | 2.0000 | 2.719 | .980 | 6.000 | II |
| MS85049/5A26B1 | MS17341N26B1 | 10-524959-292 | 28 | .680 | .567 | 1.312 | 1.875 | 1.875-16UN | 1.094 | 3.059 | 2.062 | 4.647 | 1.812 | 1.371 | 2.0000 | 2.219 | .980 | 6.000 | II |
| MS85049/5A25B1 | MS17341N25B1 | 10-524959-293 | 28 | .530 | .436 | 1.000 | 1.812 | 1.875-16UN | 1.062 | 2.875 | 2.062 | 4.431 | 1.375 | 1.375 | 2.0000 | 2.219 | .980 | 6.000 | II |
| MS85049/5A22B1 | MS17341N22B1 | 10-524959-294 | 28 | .375 | .281 | .875 | 1.875 | 1.875-16UN | .969 | 2.766 | 2.062 | 4.229 | 1.125 | 1.422 | 2.0000 | 2.219 | .980 | 6.000 | II |
| MS85049/4A23B1 | MS17342N23B1 | 10-524959-321 | 32 | 1.828 | 1.700 | 2.438 | 2.312 | 2.0625-16UN | 1.391 | 3.500 | 2.312 | 5.385 | 3.171 | 1.375 | 2.2500 | 2.469 | .980 | 6.000 | III |
| MS85049/4A25B1 | MS17342N25B1 | 10-524959-322 | 32 | 1.730 | 1.605 | 2.438 | 2.312 | 2.0625-16UN | 1.391 | 3.500 | 2.312 | 5.385 | 3.171 | 1.375 | 2.2500 | 2.469 | .980 | 6.000 | III |
| MS85049/4A22B1 | MS17342N22B1 | 10-524959-323 | 32 | 1.656 | 1.531 | 2.250 | 2.312 | 2.0625-16UN | 1.281 | 3.308 | 2.312 | 5.083 | 2.953 | 1.370 | 2.2500 | 2.469 | .980 | 6.000 | III |
| MS85049/4A24B1 | MS17342N24B1 | 10-524959-324 | 32 | 1.562 | 1.437 | 2.250 | 2.312 | 2.0625-16UN | 1.281 | 3.308 | 2.312 | 5.083 | 2.953 | 1.370 | 2.2500 | 2.469 | .980 | 6.000 | III |
| MS85049/3A24B1 | MS17340N24B1 | 10-524959-325 | 32 | 1.531 | 1.406 | 2.000 | 2.062 | 2.0625-16UN | 1.281 | 3.246 | 2.312 | 5.021 | 2.625 | 1.371 | 2.2500 | 2.469 | .980 | 6.000 | I |
| MS85049/3A23B1 | MS17340N23B1 | 10-524959-326 | 32 | 1.445 | 1.320 | 2.000 | 2.062 | 2.0625-16UN | 1.281 | 3.246 | 2.312 | 5.021 | 2.625 | 1.371 | 2.2500 | 2.469 | .980 | 6.000 | I |
| MS85049/3A25B1 | MS17340N25B1 | 10-524959-327 | 32 | 1.375 | 1.250 | 2.000 | 2.062 | 2.0625-16UN | 1.281 | 3.246 | 2.312 | 5.021 | 2.625 | 1.371 | 2.2500 | 2.469 | .980 | 6.000 | I |
| MS85049/5A28B1 | MS17341N28B1 | 10-524959-328 | 32 | 1.230 | 1.150 | 1.780 | 2.062 | 2.0625-16UN | 1.281 | 3.184 | 2.312 | 4.959 | 2.469 | 1.372 | 2.2500 | 2.469 | .980 | 6.000 | II |
| MS85049/5A35B1 | MS17341N35B1 | 10-524959-329 | 32 | 1.130 | 1.005 | 1.780 | 2.062 | 2.0625-16UN | 1.281 | 3.184 | 2.312 | 4.959 | 2.469 | 1.372 | 2.2500 | 2.469 | .980 | 6.000 | II |
| MS85049/5A31B1 | MS17341N31B1 | 10-524959-330 | 32 | 1.109 | .984 | 1.546 | 2.062 | 2.0625-16UN | 1.281 | 3.121 | 2.312 | 4.896 | 2.125 | 1.371 | 2.2500 | 2.469 | .980 | 6.000 | II |
| MS85049/5A27B1 | MS17341N27B1 | 10-524959-331 | 32 | 1.055 | .930 | 1.546 | 2.062 | 2.0625-16UN | 1.281 | 3.121 | 2.312 | 4.896 | 2.125 | 1.371 | 2.2500 | 2.469 | .980 | 6.000 | II |
| MS85049/5A32B1 | MS17341N32B1 | 10-524959-332 | 32 | .970 | .858 | 1.312 | 2.062 | 2.0625-16UN | 1.094 | 3.059 | 2.312 | 4.647 | 1.812 | 1.371 | 2.2500 | 2.469 | .980 | 6.000 | II |
| MS85049/5A30B1 | MS17341N30B1 | 10-524959-333 | 32 | .880 | .755 | 1.546 | 2.062 | 2.0625-16UN | 1.281 | 3.121 | 2.312 | 4.896 | 2.125 | 1.371 | 2.2500 | 2.469 | .980 | 6.000 | II |

* Ordering procedure: Locate shell size needed (Column 4); select cable diameter range to be accommodated within the shell size (column 5); order by either MS part number (column 1) or Proprietary part number (column 3).

MS numbers shown are non-conductive finish. To order conductive finish, substitute "W" for "A" in the part number listed.

10- numbers shown are non-conductive finish. To order conductive finish, substitute prefix 88-.

MIL-C-22992, QWLD Accessories

M85049 or 10-524959

cable sealing adapters (receptacle)

All dimensions for reference only.

| MS Part Number* | Superseded MS Part Number | Proprietary Part Number* | Used With Shell Size | Cable Range | | B +.000 -.010 | C +.000 -.010 | D Thread Class 2B-LH | E Free Length Max | F +.010 -.020 | G Dia +.010 -.020 | H Max | J ±.031 | K +.015 -.025 | L Thread Class 2A 0.1P-0.2L Double Stub | N Dia Max | P Max | Q Approx. | Type |
|-----------------|---------------------------|--------------------------|----------------------|-------------|------------|---------------------|---------------------|----------------------------|----------------------------|---------------------|----------------------------|----------|------------|---------------------|--|-----------------|----------|--------------|------|
| | | | | Max Dia | Min Dia | | | | | | | | | | | | | | |
| M85049/5A29B1 | MS17341N29B1 | 10-524959-334 | 32 | .750 | .637 | 1.312 | 2.062 | 2.0625-16UN | 1.094 | 3.059 | 2.312 | 4.647 | 1.612 | 1.371 | 2.2500 | 2.469 | .980 | 6.000 | II |
| M85049/5A34B1 | MS17341N34B1 | 10-524959-335 | 32 | .530 | .436 | 1.000 | 2.000 | 2.0625-16UN | 1.062 | 2.875 | 2.312 | 4.431 | 1.375 | 1.375 | 2.2500 | 2.469 | .980 | 6.000 | II |
| M85049/5A53B1 | MS17341N33B1 | 10-524959-336 | 32 | .375 | .281 | .875 | 2.062 | 2.0625-16UN | .969 | 2.813 | 2.312 | 4.276 | 1.125 | 1.469 | 2.2500 | 2.469 | .980 | 6.000 | II |
| M85049/4A30A1 | MS17342N30B1 | 10-524959-361 | 36 | 2.062 | 1.917 | 2.750 | 2.500 | 2.3125-16UN | 1.391 | 3.500 | 2.562 | 5.385 | 3.375 | 1.375 | 2.5000 | 2.719 | .980 | 6.000 | III |
| M85049/4A29B1 | MS17342N29B1 | 10-524959-362 | 36 | 1.984 | 1.859 | 2.438 | 2.500 | 2.3125-16UN | 1.391 | 3.469 | 2.562 | 5.354 | 3.171 | 1.344 | 2.5000 | 2.719 | .980 | 6.000 | III |
| M85049/4A26B1 | MS17342N26B1 | 10-524959-363 | 36 | 1.900 | 1.775 | 2.438 | 2.500 | 2.3125-16UN | 1.391 | 3.469 | 2.562 | 5.354 | 3.171 | 1.344 | 2.5000 | 2.719 | .980 | 6.000 | III |
| M85049/4A28B1 | MS17342N28B1 | 10-524959-364 | 36 | 1.825 | 1.700 | 2.438 | 2.500 | 2.3125-16UN | 1.391 | 3.469 | 2.562 | 5.354 | 3.171 | 1.344 | 2.5000 | 2.719 | .980 | 6.000 | III |
| M85049/4A27B1 | MS17342N27B1 | 10-524959-365 | 36 | 1.730 | 1.605 | 2.438 | 2.500 | 2.3125-16UN | 1.391 | 3.469 | 2.562 | 5.354 | 3.171 | 1.344 | 2.5000 | 2.719 | .980 | 6.000 | III |
| M85049/3A26B1 | MS17340N26B1 | 10-524959-366 | 36 | 1.656 | 1.531 | 2.250 | 2.312 | 2.3125-16UN | 1.281 | 3.308 | 2.562 | 5.083 | 2.953 | 1.370 | 2.5000 | 2.719 | .980 | 6.000 | I |
| M85049/3A27B1 | MS17340N27B1 | 10-524959-367 | 36 | 1.562 | 1.437 | 2.250 | 2.312 | 2.3125-16UN | 1.281 | 3.308 | 2.562 | 5.083 | 2.953 | 1.370 | 2.5000 | 2.719 | .980 | 6.000 | I |
| M85049/5A40B1 | MS17341N40B1 | 10-524959-368 | 36 | 1.445 | 1.320 | 2.000 | 2.312 | 2.3125-16UN | 1.281 | 3.246 | 2.562 | 5.021 | 2.625 | 1.371 | 2.5000 | 2.719 | .980 | 6.000 | II |
| M85049/5A38B1 | MS17341N38B1 | 10-524959-369 | 36 | 1.375 | 1.250 | 2.000 | 2.312 | 2.3125-16UN | 1.281 | 3.246 | 2.562 | 5.021 | 2.625 | 1.371 | 2.5000 | 2.719 | .980 | 6.000 | II |
| M85049/5A36B1 | MS17341N36B1 | 10-524959-370 | 36 | 1.310 | 1.185 | 1.780 | 2.312 | 2.3125-16UN | 1.281 | 3.184 | 2.562 | 4.959 | 2.469 | 1.372 | 2.5000 | 2.719 | .980 | 6.000 | II |
| M85049/5A42B1 | MS17341N42B1 | 10-524959-371 | 36 | 1.230 | 1.105 | 1.780 | 2.312 | 2.3125-16UN | 1.281 | 3.184 | 2.562 | 4.959 | 2.469 | 1.372 | 2.5000 | 2.719 | .980 | 6.000 | II |
| M85049/5A39B1 | MS17341N39B1 | 10-524959-372 | 36 | 1.180 | 1.055 | 1.780 | 2.312 | 2.3125-16UN | 1.281 | 3.184 | 2.562 | 4.959 | 2.469 | 1.372 | 2.5000 | 2.719 | .980 | 6.000 | II |
| M85049/5A37B1 | MS17341N37B1 | 10-524959-373 | 36 | 1.109 | .984 | 1.546 | 2.312 | 2.3125-16UN | 1.281 | 3.121 | 2.562 | 4.896 | 2.125 | 1.371 | 2.5000 | 2.719 | .980 | 6.000 | II |
| M85049/5A41B1 | MS17341N41B1 | 10-524959-374 | 36 | .970 | .857 | 1.312 | 2.250 | 2.3125-16UN | 1.094 | 3.063 | 2.562 | 4.651 | 1.812 | 1.375 | 2.5000 | 2.719 | .980 | 6.000 | II |
| M85049/4A31B1 | MS17342N31B1 | 10-524959-401 | 40 | 2.375 | 2.230 | 3.000 | 2.812 | 2.625-16UN | 1.391 | 3.609 | 2.875 | 5.682 | 3.625 | 1.421 | 2.7500 | 2.969 | .980 | 6.000 | III |
| M85049/4A32B1 | MS17342N32B1 | 10-524959-402 | 40 | 2.250 | 2.105 | 2.875 | 2.625 | 2.625-16UN | 1.391 | 3.609 | 2.875 | 5.682 | 3.500 | 1.421 | 2.7500 | 2.969 | .980 | 6.000 | III |
| M85049/4A33B1 | MS17342N33B1 | 10-524959-403 | 40 | 2.145 | 2.000 | 2.750 | 2.625 | 2.625-16UN | 1.391 | 3.547 | 2.875 | 5.620 | 3.375 | 1.422 | 2.7500 | 2.969 | .980 | 6.000 | III |
| M85049/4A34B1 | MS17342N34B1 | 10-524959-404 | 40 | 2.062 | 1.917 | 2.750 | 2.625 | 2.625-16UN | 1.391 | 3.547 | 2.875 | 5.620 | 3.375 | 1.422 | 2.7500 | 2.969 | .980 | 6.000 | III |
| M85049/5A43B1 | MS17341N43B1 | 10-524959-405 | 40 | 1.940 | 1.815 | 2.438 | 2.750 | 2.625-16UN | 1.391 | 4.281 | 2.875 | 6.334 | 3.171 | 2.156 | 2.7500 | 2.969 | .980 | 6.000 | II |
| M85049/5A44B1 | MS17341N44B1 | 10-524959-406 | 40 | 1.825 | 1.700 | 2.438 | 2.750 | 2.625-16UN | 1.391 | 4.281 | 2.875 | 6.334 | 3.171 | 2.156 | 2.7500 | 2.969 | .980 | 6.000 | II |
| M85049/5A45B1 | MS17341N45B1 | 10-524959-407 | 40 | 1.730 | 1.605 | 2.438 | 2.750 | 2.625-16UN | 1.391 | 4.281 | 2.875 | 6.334 | 3.171 | 2.156 | 2.7500 | 2.969 | .980 | 6.000 | II |
| M85049/5A46B1 | MS17341N46B1 | 10-524959-408 | 40 | 1.656 | 1.531 | 2.250 | 2.625 | 2.625-16UN | 1.281 | 4.094 | 2.875 | 6.057 | 2.953 | 2.156 | 2.7500 | 2.969 | .980 | 6.000 | II |

* Ordering procedure: Locate shell size needed (Column 4); select cable diameter range to be accommodated within the shell size (column 5); order by either MS part number (column 1) or Proprietary part number (column 3).

MS numbers shown are non-conductive finish. To order conductive finish, substitute "W" for "A" in the part number listed.

10- numbers shown are non-conductive finish. To order conductive finish, substitute prefix 88-.

MIL-C-22992, QWLD Accessories

10-350695 adapter,
10-350349 cable clamp

10-350695-XX()
 adapter

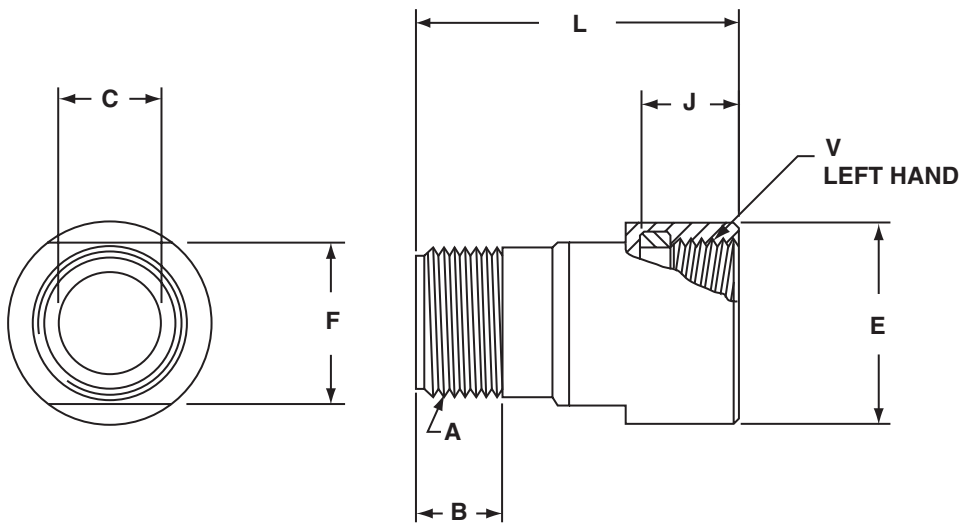

10-350349-()3
 cable clamp

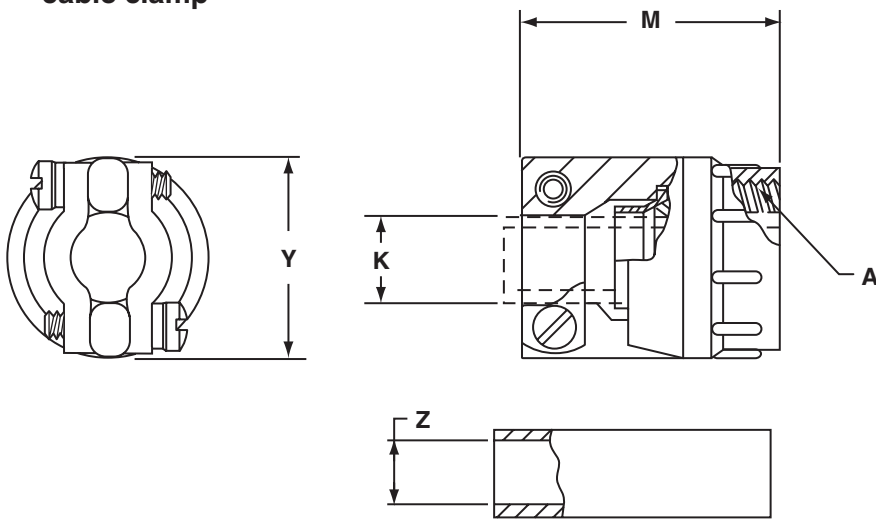

MS3420-()A
 sleeve

MIL-C-22992, QWLD Accessories

10-350695 adapter,

10-350349 cable clamp

All dimensions for reference only.

| Shell Size | Proprietary Adapter Part Number* | Clamp Part Number** | Superseded MS Part Number | A Thread Class 2A (Plated) | B Min Full Thd | C Dia +.000 - .010 | E +.010 - .020 | F ±.010 | J +.010 - .000 | K Dia | | L ±.010 | M Max | V Thread Class 2B-LH | Y Max |
|------------|----------------------------------|---------------------|---------------------------|----------------------------|----------------|--------------------|----------------|---------|----------------|-------|--------|---------|-------|----------------------|-------|
| | | | | | | | | | | Free | Closed | | | | |
| 12 | 10-350695-13() | 10-350349-12() | MS3057-4C | .625-24UNEF | .422 | .386 | .875 | .688 | .484 | .302 | .094 | 1.609 | 1.375 | .750-20UNEF | .906 |
| 14 | 10-350695-15() | 10-350349-14() | MS3057-6C | .750-20UNEF | .422 | .500 | 1.000 | .812 | .484 | .428 | .230 | 1.609 | 1.375 | .875-20UNEF | 1.031 |
| 16 | 10-350695-17() | 10-350349-16() | MS3057-8C | .875-20UNEF | .422 | .625 | 1.188 | .938 | .481 | .515 | .316 | 1.609 | 1.375 | 1.000-20UNEF | 1.125 |
| 18 | 10-350695-18() | 10-350349-18() | MS3057-10C | 1.000-20UNEF | .422 | .752 | 1.312 | 1.062 | .481 | .614 | .378 | 1.609 | 1.437 | 1.125-18UNEF | 1.234 |
| 20 | 10-350695-20() | 10-350349-20() | MS3057-12C | 1.1875-18UNEF | .422 | .891 | 1.438 | 1.250 | .481 | .738 | .445 | 1.609 | 1.437 | 1.250-18UNEF | 1.484 |
| 22 | 10-350695-22() | 10-350349-20() | MS3057-12C | 1.1875-18UNEF | .422 | .891 | 1.562 | 1.250 | .481 | .738 | .445 | 1.609 | 1.437 | 1.375-18UNEF | 1.484 |
| 24 | 10-350695-24() | 10-350349-24() | MS3057-16C | 1.4375-18UNEF | .422 | 1.111 | 1.812 | 1.500 | .481 | .926 | .611 | 1.609 | 1.562 | 1.625-18UNEF | 1.671 |
| 28 | 10-350695-28() | 10-350349-24() | MS3057-16C | 1.4375-18UNEF | .422 | 1.111 | 2.062 | 1.500 | .481 | .926 | .611 | 1.781 | 1.562 | 1.875-16UN | 1.671 |
| 32 | 10-350695-32() | 10-350349-32() | MS3057-20C | 1.750-18UNS | .484 | 1.422 | 2.250 | 1.875 | .481 | 1.200 | .922 | 1.781 | 1.812 | 2.0625-16UNS | 2.188 |
| 36 | 10-350695-36() | 10-350349-36() | MS3057-24C | 2.000-18UNS | .562 | 1.672 | 2.500 | 2.125 | .481 | 1.363 | .922 | 1.781 | 2.062 | 2.3125-16UNS | 2.344 |
| 40 | 10-350695-40() | 10-350349-40() | MS3057-28C | 2.250-16UN | .562 | 1.914 | 2.812 | 2.375 | .672 | 1.611 | 1.180 | 2.032 | 2.062 | 2.625-16UN | 2.594 |

* To attach the cable clamp to the left hand accessory threads of QWLD connectors, adapter 10-350695-XX is needed. Order this proprietary adapter from column 2 and suffix the part number with the finish desired, listed in the finish chart below.

** Order MS clamp (column 3) to accommodate the cable type being used. Standard finish on the clamp is olive drab, cadmium plate.

| Shell Size | Sleeve† MS Part Number | Z Dia | |
|------------|------------------------|------------|--------|
| | | Free ±.016 | Closed |
| 12 | MS3420-4A | .219 | .010 |
| 14 | MS3420-4A | .219 | .020 |
| | MS3420-6A | .312 | .114 |
| 16 | MS3420-6A | .312 | .085 |
| | MS3420-8A | .438 | .222 |
| 18 | MS3420-6A | .312 | .085 |
| | MS3420-10A | .438 | .200 |
| 20 | MS3420-8A | .438 | .177 |
| | MS3420-12A | .541 | .270 |
| 22 | MS3420-8A | .438 | .177 |
| | MS3420-12A | .541 | .270 |
| 24 | MS3420-8A | .438 | .186 |
| | MS3420-12A | .541 | .260 |
| | MS3420-16A | .750 | .433 |
| 28 | MS3420-8A | .438 | .186 |
| | MS3420-12A | .541 | .260 |
| | MS3420-16A | .750 | .433 |
| 32 | MS3420-12A | .541 | .273 |
| | MS3420-16A | .750 | .442 |
| | MS3420-20A | .938 | .620 |
| 36 | MS3420-16A | .750 | .358 |
| | MS3420-18A | .938 | .504 |
| | MS3420-24A | 1.125 | .682 |
| 40 | MS3420-16A | .750 | .368 |
| | MS3420-20A | .938 | .514 |
| | MS3420-28A | 1.250 | .816 |

†Sleeve not supplied as part of assembly. Order separately by part number shown

| Finish Chart for Adapter & Clamp | Suffix |
|---------------------------------------|--------|
| Bright Cadmium Plate | -XX1 |
| Black Anodize | -XX2 |
| Olive Drab, Cadmium Plate | -XX3 |
| Gray Anodize | -XX4 |
| Anodic Coating | -XX* |
| Olive Drab Cadmium Plate, Nickel Base | -XX9 |

* No third digit required for 10-350695 and not available for 10-350349.

MIL-C-22992, QWLD Accessories

protective covers

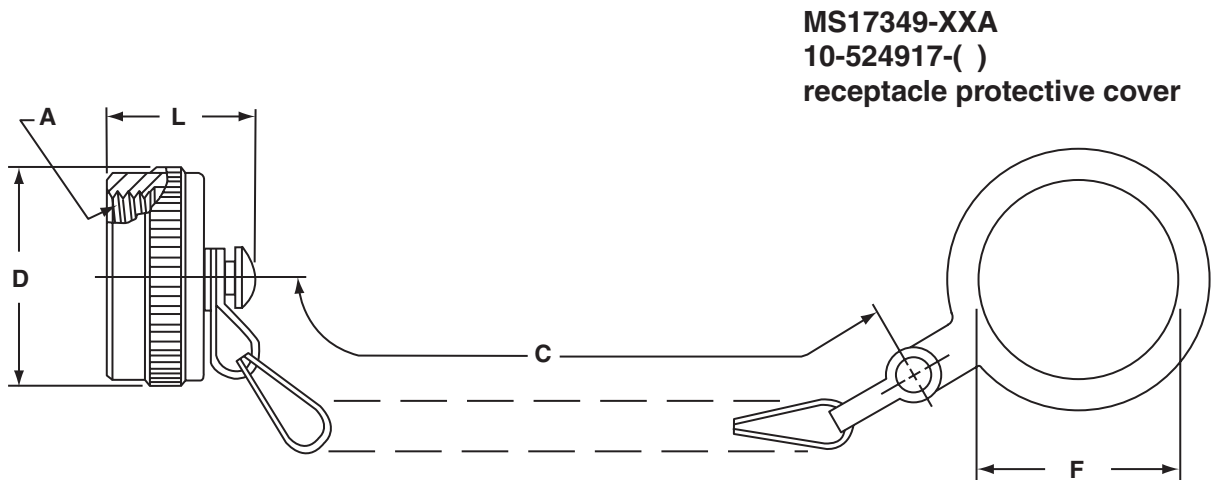
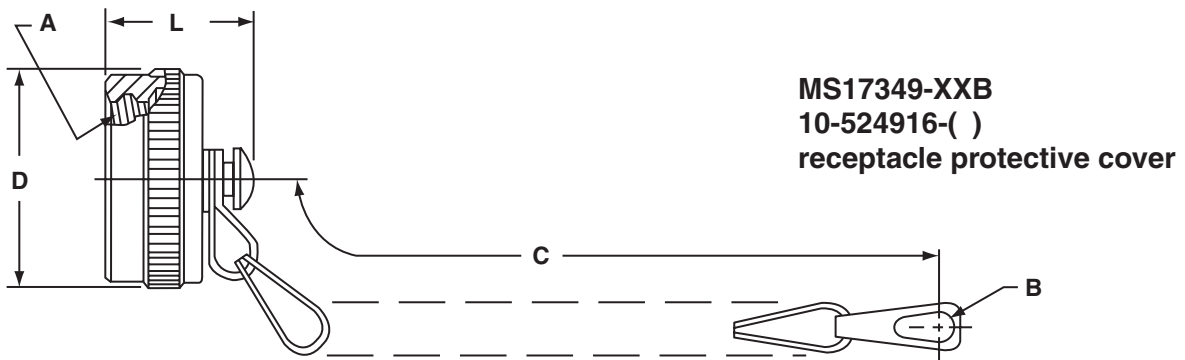
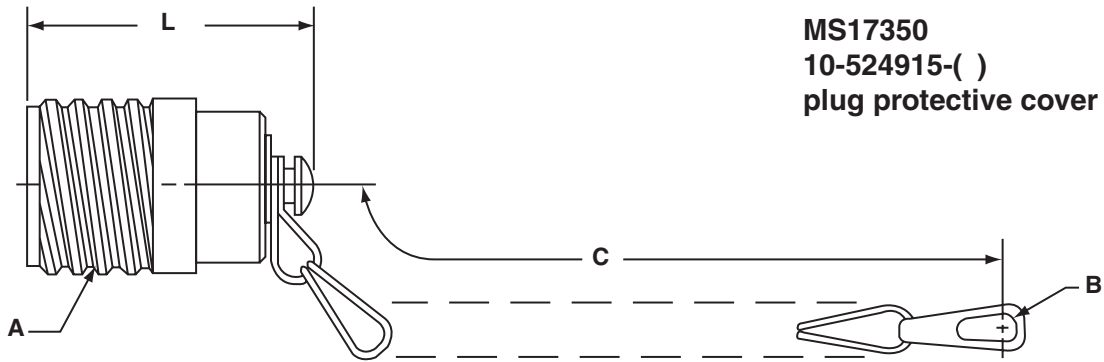

MIL-C-22992, QWLD Accessories

protective covers

All dimensions for reference only.

| Shell Size | Plug Protective Cover MS Part Number* | Plug Protective Cover Proprietary Part Number** | A Thread Class 2A (Plated) 0.1P-0.2L Double Stub | B Dia +.010 -.005 | C Approx. | L Max |
|------------|---------------------------------------|---|--|-------------------|-----------|-------|
| 12 | MS17350-() | 10-524915-12() | .8750 | .156 | 5.000 | 1.500 |
| 14 | MS17350-() | 10-524915-14() | 1.0000 | .156 | 5.000 | 1.500 |
| 16 | MS17350-() | 10-524915-16() | 1.1250 | .156 | 5.000 | 1.500 |
| 18 | MS17350-() | 10-524915-18() | 1.2500 | .180 | 5.000 | 1.500 |
| 20 | MS17350-() | 10-524915-20() | 1.3750 | .180 | 5.000 | 1.500 |
| 22 | MS17350-() | 10-524915-22() | 1.5000 | .180 | 6.000 | 1.500 |
| 24 | MS17350-() | 10-524915-24() | 1.7500 | .180 | 6.000 | 1.500 |
| 28 | MS17350-() | 10-524915-28() | 2.0000 | .180 | 6.000 | 1.500 |
| 32 | MS17350-() | 10-524915-32() | 2.2500 | .209 | 6.000 | 1.500 |
| 36 | MS17350-() | 10-524915-36() | 2.5000 | .209 | 6.000 | 1.500 |
| 40 | MS17350-() | 10-524915-40() | 2.7500 | .209 | 6.000 | 1.500 |

*Order MS-approved covers as per coded part number example:

| PART NUMBER | | | |
|----------------|----------|-----------|----------|
| <u>MS17350</u> | <u>C</u> | <u>28</u> | <u>A</u> |
| 1 | 2 | 3 | 4 |

- MS Number** - MS17350 designated plug protective cover MS17349 designated receptacle protect cover
- Cover Finish** - C for conductive, N for non-conductive.
- Cover Size** - Shell size of connector with which cover is used.
- Cover Type** - (MS17349 only) -
A - Washer Termination, used with:
MS17345 line (cable connecting) plug
MS17347 jam nut receptacle
MS17348 jam nut receptacle
B - Eyelet Termination - used with:
MS17343 wall mount receptacle
MS17346 box mount receptacle

**Order Proprietary covers as per coded part number example:

| PART NUMBER | | | |
|------------------|---|-----------|----------|
| <u>10-524915</u> | - | <u>28</u> | <u>5</u> |
| 1 | | 2 | 3 |

| Shell Size | Receptacle Protective Cover MS Part Number* | Receptacle Protective Cover Proprietary Part Number** | A Thread Class 2B 0.1P-0.2L Double Stub | B +.010 -.005 | C Approx. | D Dia. Max | F +.010 -.000 | L Max |
|------------|---|---|---|---------------|-----------|------------|---------------|-------|
| 12 | MS17349-()B MS17349-()A | 10-524916-12() 10-524917-12() | .8750 | .156 | 5.000 | 1.094 | 1.016 | .765 |
| 14 | MS17349-()B MS17349-()A | 10-524916-14() 10-524917-14() | 1.0000 | .156 | 5.000 | 1.219 | 1.141 | .765 |
| 16 | MS17349-()B MS17349-()A | 10-524916-16() 10-524917-16() | 1.1250 | .156 | 5.000 | 1.344 | 1.266 | .980 |
| 18 | MS17349-()B MS17349-()A | 10-524916-18() 10-524917-18() | 1.2500 | .180 | 5.000 | 1.469 | 1.391 | .980 |
| 20 | MS17349-()B MS17349-()A | 10-524916-20() 10-524917-20() | 1.3750 | .180 | 5.000 | 1.562 | 1.516 | .980 |
| 22 | MS17349-()B MS17349-()A | 10-524916-22() 10-524917-22() | 1.5000 | .180 | 6.000 | 1.688 | 1.641 | .980 |
| 24 | MS17349-()B MS17349-()A | 10-524916-24() 10-524917-24() | 1.7500 | .180 | 6.000 | 1.938 | 1.891 | .980 |
| 28 | MS17349-()B MS17349-()A | 10-524916-28() 10-524917-28() | 2.0000 | .180 | 6.000 | 2.219 | 2.141 | .980 |
| 32 | MS17349-()B MS17349-()A | 10-524916-32() 10-524917-32() | 2.2500 | .209 | 6.000 | 2.469 | 2.391 | .980 |
| 36 | MS17349-()B MS17349-()A | 10-524916-36() 10-524917-36() | 2.5000 | .209 | 6.000 | 2.719 | 2.641 | .980 |
| 40 | MS17349-()B MS17349-()A | 10-524916-40() 10-524917-40() | 2.7500 | .209 | 6.000 | 2.969 | 2.891 | .980 |

- Base Number** - 10-524915 designates plug cover with chain 10-524916 designates receptacle cover with chain 10-524917 designates receptacle cover with chain and attaching ring
- Cover Size** - Shell size of connector with which cover is used.
- Finish** -
5 - Non-conductive Alumilite finish
9 - Conductive olive drab cadmium plate over nickel finish

Note:
Protective covers are supplied with all M85049 style cable sealing adapters.

QWLD Accessories

sealing gaskets

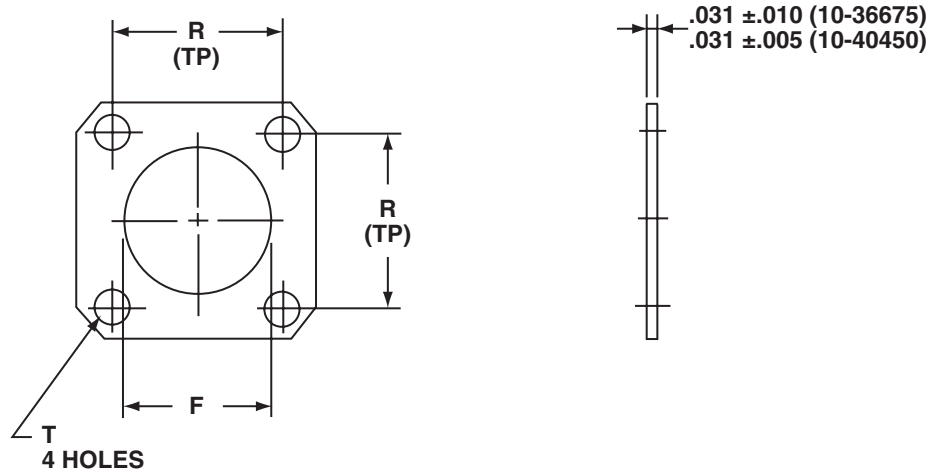

All dimensions for reference only.

| Part Number* | Shell Size | F Dia +.016 -.000 | R ±.010 | T Dia ±.010 |
|--------------|------------|-------------------------|------------|----------------|
| 10-36675-14 | 12 | .875 | .906 | .172 |
| 10-36675-16 | 14 | 1.000 | .969 | .172 |
| 10-36675-18 | 16 | 1.125 | 1.063 | .203 |
| 10-36675-20 | 18 | 1.250 | 1.156 | .203 |
| 10-36675-22 | 20 | 1.375 | 1.250 | .203 |
| 10-36675-24 | 22 | 1.500 | 1.375 | .203 |
| 10-36675-28 | 24 | 1.750 | 1.563 | .203 |
| 10-36675-32 | 28 | 2.000 | 1.750 | .219 |
| 10-36675-36 | 32 | 2.188 | 1.938 | .219 |
| 10-36675-40 | 36 | 2.438 | 2.188 | .219 |
| 10-36675-44 | 40 | 2.688 | 2.375 | .219 |
| 10-36675-48 | 44 | 2.938 | 2.625 | .219 |

*10-36675-() for operating temperature range - 67° to + 275°F.
Order by part number listed to accommodate shell size being used.

| Part Number** | Shell Size | F Dia +.016 -.000 | R ±.010 | T Dia ±.010 |
|---------------|------------|-------------------------|------------|----------------|
| 10-40450-14 | 12 | .875 | .906 | .172 |
| 10-40450-16 | 14 | 1.000 | .969 | .172 |
| 10-40450-18 | 16 | 1.125 | 1.063 | .203 |
| 10-40450-20 | 18 | 1.250 | 1.156 | .203 |
| 10-40450-22 | 20 | 1.375 | 1.250 | .203 |
| 10-40450-24 | 22 | 1.500 | 1.375 | .203 |
| 10-40450-28 | 24 | 1.750 | 1.563 | .203 |
| 10-40450-32 | 28 | 2.000 | 1.750 | .219 |
| 10-40450-36 | 32 | 2.188 | 1.938 | .219 |
| 10-40450-40 | 36 | 2.437 | 2.188 | .219 |
| 10-40450-44 | 40 | 2.688 | 2.375 | .219 |
| 10-40450-48 | 44 | 2.938 | 2.625 | .219 |

**10-40450-() for operating temperature range 0° to + 275°F.
Order by part number listed to accommodate shell size being used.

QWLD Accessories

encapsulation adapter

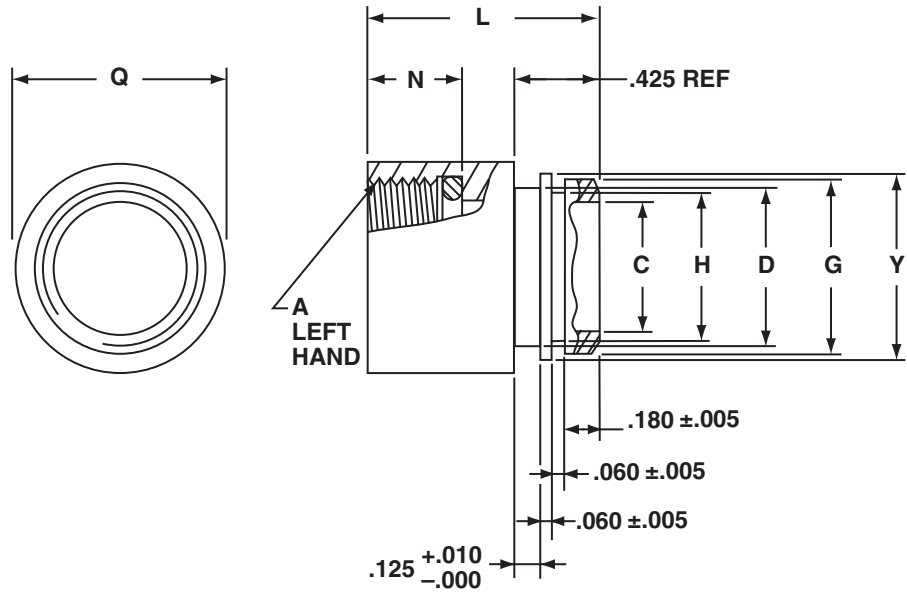

All dimensions for reference only.

| Part Number* | Shell Size | A Thread Class 2B-LH | C Dia ±.031 | D Dia ±.005 | G ^{+.010} / _{-.000} | H Dia ±.005 | L ±.031 | N ±.016 | Q ±.010 | Y Dia |
|-----------------|------------|----------------------|-------------|-------------|---------------------------------------|-------------|---------|---------|---------|-------|
| 10-242067-13() | 12 | .750-20UNEF | .500 | .673 | .766 | .673 | 1.175 | .479 | .923 | .798 |
| 10-242067-15() | 14 | .875-20UNEF | .656 | .797 | .844 | .797 | 1.175 | .479 | 1.047 | .922 |
| 10-242067-17() | 16 | 1.000-20UNEF | .813 | .923 | .969 | .923 | 1.175 | .479 | 1.172 | 1.048 |
| 10-242067-18() | 18 | 1.125-18UNEF | .938 | 1.047 | 1.094 | 1.047 | 1.175 | .479 | 1.297 | 1.172 |
| 10-242067-20() | 20 | 1.250-18UNEF | 1.063 | 1.172 | 1.219 | 1.172 | 1.175 | .479 | 1.422 | 1.297 |
| 10-242067-22() | 22 | 1.375-18UNEF | 1.188 | 1.297 | 1.344 | 1.297 | 1.175 | .479 | 1.547 | 1.423 |
| 10-242067-24() | 24 | 1.625-18UNEF | 1.312 | 1.537 | 1.469 | 1.422 | 1.175 | .479 | 1.787 | 1.662 |
| 10-242067-28() | 28 | 1.875-16UN | 1.500 | 1.797 | 1.719 | 1.679 | 1.175 | .479 | 2.047 | 1.922 |
| 10-242067-32() | 32 | 2.0625-16UN | 1.800 | 2.047 | 2.000 | 1.960 | 1.175 | .479 | 2.297 | 2.172 |
| 10-242067-36() | 36 | 2.3125-16UN | 2.000 | 2.297 | 2.219 | 2.179 | 1.175 | .479 | 2.547 | 2.422 |
| 10-242067-40() | 40 | 2.625-16UN | 2.250 | 2.609 | 2.469 | 2.429 | 1.375 | .667 | 2.859 | 2.734 |
| 10-242067-44() | 44 | 2.875-16UN | 2.459 | 2.857 | 2.782 | 2.742 | 1.375 | .667 | 3.110 | 2.982 |
| 10-242067-48() | 48 | 3.125-16UN | 2.719 | 3.107 | 3.046 | 3.004 | 1.375 | .667 | 3.360 | 3.244 |

*Order by part number listed to accommodate shell size being used. To complete part number add suffix for finish desired from table below.

| Finish | Suffix |
|---------------------------|--------|
| Bright Cadmium Plate | -XX1 |
| Black Anodize | -XX2 |
| Cadmium Plate, Olive Drab | -XX3 |
| Gray Anodize | -XX4 |
| Anodic Coating | -XX5 |
| Cadmium Plate Nickel Base | -XX7 |

QWLD Accessories

encapsulation end bell

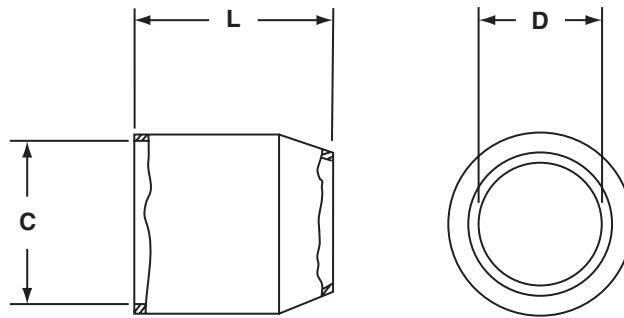

All dimensions are for reference only.

| Part Number* | C Dia | D Dia ±.010 | L ±.010 |
|--------------|--|----------------|------------|
| 10-130999-13 | .766 ^{+0.000} / _{-.010} | .484 | 1.273 |
| 10-130999-15 | .844 ^{+0.000} / _{-.010} | .609 | 1.273 |
| 10-130999-17 | .969 ^{+0.000} / _{-.010} | .734 | 1.273 |
| 10-130999-18 | 1.094 ^{+0.000} / _{-.010} | .859 | 1.242 |
| 10-130999-20 | 1.219 ^{+0.000} / _{-.015} | .984 | 1.242 |
| 10-130999-22 | 1.344 ^{+0.000} / _{-.015} | 1.109 | 1.242 |
| 10-130999-24 | 1.469 ^{+0.000} / _{-.015} | 1.234 | 1.179 |
| 10-130999-28 | 1.719 ^{+0.000} / _{-.015} | 1.427 | 1.179 |
| 10-130999-32 | 2.000 ^{+0.000} / _{-.020} | 1.708 | 1.101 |
| 10-130999-36 | 2.219 ^{+0.000} / _{-.020} | 1.895 | 1.101 |
| 10-130999-40 | 2.469 ^{+0.000} / _{-.020} | 2.130 | 1.101 |
| 10-130999-44 | 2.782 ^{+0.000} / _{-.020} | 2.443 | 1.101 |
| 10-130999-48 | 3.046 ^{+0.000} / _{-.020} | 2.707 | 1.101 |

*Order by part number listed to accommodate shell size being used.

MIL-C-22992, QWLD

MS solder contacts

Machine copper alloy contacts in a full range of sizes, with closed entry socket design in the size 12 and 16 contacts. A heavy silver-plated finish is deposited on all MS style solder contacts for maximum corrosion resistance, maximum current carrying capacity and low millivolt drop. Gold plated contacts are also available (See how to order, page 22).

SOLDER CONTACTS*

| Part Number | Pin/Socket | Mating End Size | Wire Barrel Size | Allowable Wire Size | Test Current** Amps |
|----------------------------|---------------|-----------------|------------------|----------------------|----------------------|
| 10-36982-3 10-36983-3 | Pin Socket | 16 Long | 16 | 16 18 20 22 | 13 10 7.5 5 |
| 10-36982-5 10-36983-5 | Pin Socket | 12 | 12 | 12 10 | 23 17 |
| 10-407028-8 10-407029-8 | Pin Socket | 8 | 8 | 8 10 | 46 33 |
| 10-407028-4 10-407029-4 | Pin Socket | 4 | 4 | 4 6 | 80 60 |
| 10-407028-3 10-407029-3 | Pin Socket | 0 | 0 | 0 1 2 | 150 125 100 |

* Solder Wells Unfilled

** Contact ratings as stated are test ratings only. The connector could not withstand full rated current through all contacts continuously. Please note that the electrical data given is not an establishment of electrical safety factors. This is left entirely in the designer's hands as he can best determine which peak voltage, switching surges, transients, etc. can be expected in a particular circuit.

Table I
CONTACT ARRANGEMENT
SERVICE RATING

| MS Service Rating | Recommended Operating Voltage* at Sea Level | | Effective Creepage Distance Nom. | Mechanical Spacing Nom. |
|-------------------|---|---------|----------------------------------|-------------------------|
| | DC | AC(RMS) | | |
| Inst. | 250 | 200 | 1/16 | |
| A | 700 | 500 | 1/8 | 1/16 |
| D | 1250 | 900 | 3/16 | 1/8 |
| E | 1750 | 1250 | 1/4 | 3/16 |
| B | 2450 | 1750 | 5/16 | 1/4 |
| C | 4200 | 3000 | 1 | 5/16 |

* The values listed in Table I represent operating values which include a generous safety factor. It may be necessary for some applications to exceed the operating voltages listed here. If this is necessary, designers will find Table II useful for determining the degree to which the recommended values of Table I can be exceeded.

Table II
ALTITUDE VOLTAGE
DERATING CHART**

| MS Service Rating | Nominal Distance | | Standard Sea Level Conditions | | Pressure Altitude† 50,000 Feet | | Pressure Altitude† 70,000 Feet | |
|-------------------|------------------|----------|-----------------------------------|----------------------|-----------------------------------|----------------------|-----------------------------------|----------------------|
| | Airspace | Creepage | Minimum Flashover Voltage AC(RMS) | Test Voltage AC(RMS) | Minimum Flashover Voltage AC(RMS) | Test Voltage AC(RMS) | Minimum Flashover Voltage AC(RMS) | Test Voltage AC(RMS) |
| Inst. | 1/32 | 1/16 | 1400 | 1000 | 550 | 400 | 325 | 260 |
| A | 1/16 | 1/8 | 2800 | 2000 | 800 | 600 | 450 | 360 |
| D | 1/8 | 3/16 | 3600 | 2800 | 900 | 675 | 500 | 400 |
| E | 3/16 | 1/4 | 4500 | 3500 | 1000 | 750 | 550 | 440 |
| B | 1/4 | 5/16 | 5700 | 4500 | 1100 | 825 | 600 | 480 |
| C | 5/16 | 1 | 8500 | 7000 | 1300 | 975 | 700 | 560 |

† Not corrected for changes in density due to variations in temperature.

** No attempt has been made to recommend operating voltages. The designer must determine his own operating voltage by the application of a safety factor to the above derating chart to compensate for circuit transients, surges, etc.

QWLD

solderless (crimp) contacts

Machined from copper alloys and silver-plated for maximum corrosion resistance, with a minimum millivolt drop and a maximum current carrying capacity, the size 16 and 12 socket contacts are of the closed entry design. Crimp contacts are available for all MS insert arrangements and are identified with an Amphenol® proprietary number. Gold plated contacts are also available (See how to order, page 22).

CRIMP CONTACTS*

| Part Number | Pin/Socket | Mating End Size | Wire Barrel Size | Allowable Wire Size | Required Wire Adapter Sleeve | Test Current** Amps |
|------------------------------|------------|-----------------|------------------|---------------------|------------------------------|---------------------|
| 10-40557 | Pin | 16 Long | 16 | 16 | — | 13 |
| 10-40556 or 10-597109-171 | Socket | | | 18 | — | 10 |
| | | | | 20 | — | 7.5 |
| | | | | 22* | 10-74696-6 | 5 |
| 10-40561 | Pin | 12 | 12 | 12 | — | 23 |
| 10-40560 or 10-597109-131 | Socket | | | 14 | — | 17 |
| 10-40792 | Pin | 8 | 8 | 8 | — | 46 |
| 10-40793 | Socket | | | 10* | 10-74696-1 | 33 |
| 10-40564 | Pin | 4 | 4 | 4 | — | 80 |
| 10-40565 | Socket | | | 6* | 10-74696-2 | 60 |
| 10-40562 | Pin | 0 | 0 | 0 | — | 150 |
| 10-40563 | Socket | | | 2* | 10-74696-7 | 100 |

* When using wire adapter sleeve shown.

** Contact ratings as stated are test ratings only. The connector could not withstand full rated current through all contacts continuously. Please note that the electrical data given is not an establishment of electrical safety factors. This is left entirely in the designer's hands as he can best determine which peak voltage, switching surges, transients, etc. can be expected in a particular circuit.

Table I
CONTACT ARRANGEMENT
SERVICE RATING

| MS Service Rating | Recommended Operating Voltage* at Sea Level | | Effective Creepage Distance Nom. | Mechanical Spacing Nom. |
|-------------------|---|----------|----------------------------------|-------------------------|
| | DC | AC (RMS) | | |
| Inst. | 250 | 200 | 1/16 | |
| A | 700 | 500 | 1/8 | 1/16 |
| D | 1250 | 900 | 3/16 | 1/8 |
| E | 1750 | 1250 | 1/4 | 3/16 |
| B | 2450 | 1750 | 5/16 | 1/4 |
| C | 4200 | 3000 | 1 | 5/16 |

* The values listed in Table I represent operating values which include a generous safety factor. It may be necessary for some applications to exceed the operating voltages listed here. If this is necessary, designers will find Table II useful for determining the degree to which the recommended values of Table I can be exceeded.

Table II
ALTITUDE VOLTAGE
DERATING**

| MS Service Rating | Nominal Distance | | Standard Sea Level Conditions | | Pressure Altitude† 50,000 feet | | Pressure Altitude† 70,000 feet | |
|-------------------|------------------|----------|------------------------------------|-----------------------|------------------------------------|-----------------------|------------------------------------|-----------------------|
| | Airspace | Creepage | Minimum Flashover Voltage AC (RMS) | Test Voltage AC (RMS) | Minimum Flashover Voltage AC (RMS) | Test Voltage AC (RMS) | Minimum Flashover Voltage AC (RMS) | Test Voltage AC (RMS) |
| Inst. | 1/32 | 1/16 | 1400 | 1000 | 550 | 400 | 325 | 260 |
| A | 1/16 | 1/8 | 2800 | 2000 | 800 | 600 | 450 | 360 |
| D | 1/8 | 3/16 | 3600 | 2800 | 900 | 675 | 500 | 400 |
| E | 3/16 | 1/4 | 4500 | 3500 | 1000 | 750 | 550 | 440 |
| B | 1/4 | 5/16 | 5700 | 4500 | 1100 | 825 | 600 | 480 |
| C | 5/16 | 1 | 8500 | 7000 | 1300 | 975 | 700 | 560 |

† Not corrected for changes in density due to variations in temperature.

** No attempt has been made to recommend operating voltages. The designer must determine his own operating voltage by the application of a safety factor to the above derating chart to compensate for circuit transients, surges, etc.

QWLD

application tools

Complete installation instructions (L-615) for Amphenol® QWLD Series Connectors are available on request.

The following data includes information pertaining to the application tools which have been established for crimping, inserting and removing crimp contacts used in QWLD Series Connectors.

Contact Crimping, Insertion & Removal Tools

| Crimping Tool | Positioner/ Turret | Contact Size | Contact Style | Insertion Tool | Removal Tool |
|---------------|-----------------------|--------------|---------------|----------------|-------------------------------------|
| M22520/1-01 | * | 16 | Pin & Socket | 11-7345 | 11-8250 Kit |
| M22520/1-01 | * | 12 | Pin & Socket | 11-7082 | 11-8250 Kit |
| ** | ** | 8 | Pin & Socket | 11-8220 | 11-8250 Kit |
| ** | ** | 4 | Pin & Socket | 11-7365-4† | Pin 11-7370-4† Socket 11-7674-2† |
| ** | ** | 0 | Pin & Socket | 11-7365-5† | Pin 11-7370-5† Socket 11-7674-3† |

* Use Daniels Turret TH29-1 or Astro Tool Co. Turret 616266

** For appropriate crimp tool and positioner refer to Pico Crimping Tool Co.

† Tool used with Arbor press 11-7364.

Amphenol® Heavy Duty Cylindrical Connectors

QWL Series



wall mount receptacle



thru bulkhead receptacle



cable connecting plug



straight plug



box mount receptacle



flange mount plug



jam nut receptacle
(wall mount)



jam nut receptacle
(box mount)

Amphenol® QWL Series Connectors are tailor made for compact, heavy duty industrial use.

The outstanding performance of this series makes it well suited for ship-board installations and ground support power distribution applications where physical strength and dependability are key requirements.

The QWL Series are a versatile, economical alternative to military qualified designs.

Equivalent MS shell sizes and insert arrangements offer compatibility with all standard cable types. MIL-C-22992 environmental connector requirements (see page 1) are used as a performance criteria base for this series to assure reliability under the most severe conditions.

The design features of this connector series provide:

- **Exceptional Service** - high strength aluminum shells with Alu-milite 225* hard anodic finish and shock resistant resilient inserts.
- **Foolproof Operation** - rugged double stub coupling threads, left hand accessory threads and simple single keyway mating.
- **Versatility** - both MS and custom insert patterns available for a wide variety of multiconductor cables.

A complete line of accessories is available for use with QWL Series connectors, including cable sealing and clamp adapters, protective covers, flange gaskets and banding clamps.

For further information concerning Amphenol® QWL Series connectors, request catalog 12-053 or contact your local sales office.

* Registered trademark of Aluminum Company of America

Данный компонент на территории Российской Федерации

Вы можете приобрести в компании MosChip.

Для оперативного оформления запроса Вам необходимо перейти по данной ссылке:

<http://moschip.ru/get-element>

Вы можете разместить у нас заказ для любого Вашего проекта, будь то серийное производство или разработка единичного прибора.

В нашем ассортименте представлены ведущие мировые производители активных и пассивных электронных компонентов.

Нашей специализацией является поставка электронной компонентной базы двойного назначения, продукции таких производителей как XILINX, Intel (ex.ALTERA), Vicor, Microchip, Texas Instruments, Analog Devices, Mini-Circuits, Amphenol, Glenair.

Сотрудничество с глобальными дистрибьюторами электронных компонентов, предоставляет возможность заказывать и получать с международных складов практически любой перечень компонентов в оптимальные для Вас сроки.

На всех этапах разработки и производства наши партнеры могут получить квалифицированную поддержку опытных инженеров.

Система менеджмента качества компании отвечает требованиям в соответствии с ГОСТ Р ИСО 9001, ГОСТ РВ 0015-002 и ЭС РД 009

Офис по работе с юридическими лицами:

105318, г.Москва, ул.Щербаковская д.3, офис 1107, 1118, ДЦ «Щербаковский»

Телефон: +7 495 668-12-70 (многоканальный)

Факс: +7 495 668-12-70 (доб.304)

E-mail: info@moschip.ru

Skype отдела продаж:

moschip.ru

moschip.ru_4

moschip.ru_6

moschip.ru_9