



## ■PIN CONFIGURATION



No.	Symbol	Function	No.	Symbol	Function
1	IN1	Input 1	11	V+	Power Supply Pin
2	OUT1	Output 1	12	Vref	Reference Voltage
3	IN2	Input 2	13	AUX0	Auxiliary Output0
4	OUT2	Output 2	14	AUX1	Auxiliary Output1
5	CVOL1	DAC Output for Volume 1	15	CVOL4	DAC Output for Volume 4
6	CVOL2	DAC Output for Volume 2	16	CVOL3	DAC Output for Volume 3
7	ADR	Slave Address Setting	17	OUT4	Output 4
8	SDA	SDA Data Input (I <sup>2</sup> C BUS)	18	IN4	Input 4
9	SCL	SCL Data Input (I <sup>2</sup> C BUS)	19	OUT3	Output 3
10	GND	GND	20	IN3	Input 3

## ■ ABSOLUTE MAXIMUM RATING (Ta=25°C)

PARAMETER	SYMBOL	RATING	UNIT
Supply Voltage	V <sup>+</sup>	15	V
Maximum Input Voltage	V <sub>IM</sub>	0 to V <sup>+</sup> (*)	V
Power Dissipation	P <sub>D</sub>	DMP20 : 350	mW
Operating Temperature Range	Topr	-40 to +85	°C
Storage Temperature Range	Tstg	-40 to +125	°C

(\*) For the maximum input voltage less than 0 to V<sup>+</sup>

## ■ ELECTRICAL CHARACTERISTICS

(Ta=25°C, V+=9V, R<sub>L</sub>=47kΩ, Vin=100mVrms/1kHz, unless otherwise specified)

### ● POWER SUPPLY

PARAMETER	SYMBOL	TEST CONDITION	MIN.	TYP.	MAX.	UNIT
Operating Voltage	V <sup>+</sup>		7.5	9.0	13.0	V
Supply Current	I <sub>CC</sub>	No Signal	-	4	10	mA
Reference Voltage	V <sub>REF</sub>	No Signal	4.0	4.5	5.0	V

### ● VOLUME

PARAMETER	SYMBOL	TEST CONDITION	MIN.	TYP.	MAX.	UNIT
Maximum Input Voltage	V <sub>IM</sub>	VOL=-20dB, THD=1%	2.8	3.0	-	Vrms
Maximum Output Voltage	V <sub>OM</sub>	OUTPUT VOL=0dB, THD=1%	-	2.5	-	Vrms
Channel Balance	G <sub>CB</sub>	VOL=0dB	-1.0	0.0	1.0	dB
Total Harmonic Distortion	THD	Vo=0.5Vrms BW=400Hz to 30kHz	-	-	0.3	%
Maximum Gain	G <sub>VMAX</sub>	VOL= 0dB	-2.0	0.0	2.0	dB
Minimum Gain	G <sub>VMIN</sub>	VOL= MUTE, Vin=2Vrms	-	-100	-90	dB
Channel Separation	CS	Vin = 1Vrms A-weighting	-	-80	-70	dB
Output Noise 1	V <sub>NO1</sub>	VOL = 0dB A-weighting	-	-90 (31.6)	-85 (56.2)	dBV (μVrms)
Output Noise 2	V <sub>NO2</sub>	VOL = MUTE A-weighting	-	-106 (5.0)	-96 (15.8)	dBV (μVrms)
Input Impedance	R <sub>i</sub>		-	20	-	kΩ
AUX Output Voltage	V <sub>AUX</sub>	Logic Output: High	4.5	-	5.5	V
		Logic Output: Low	0	-	0.5	

BW: Band Width

### ● CONTROL

PARAMETER	SYMBOL	TEST CONDITION	MIN.	TYP.	MAX.	UNIT
High Level Input Voltage	V <sub>ADRH</sub>	High : Slave Address 82H	V <sup>+</sup> /2	-	-	V
Low Level Input Voltage	V <sub>ADRL</sub>	Low : Slave Address 80H	-	-	1.0	V

## ■TIMING ON THE I<sup>2</sup>C BUS (SDA,SCL)

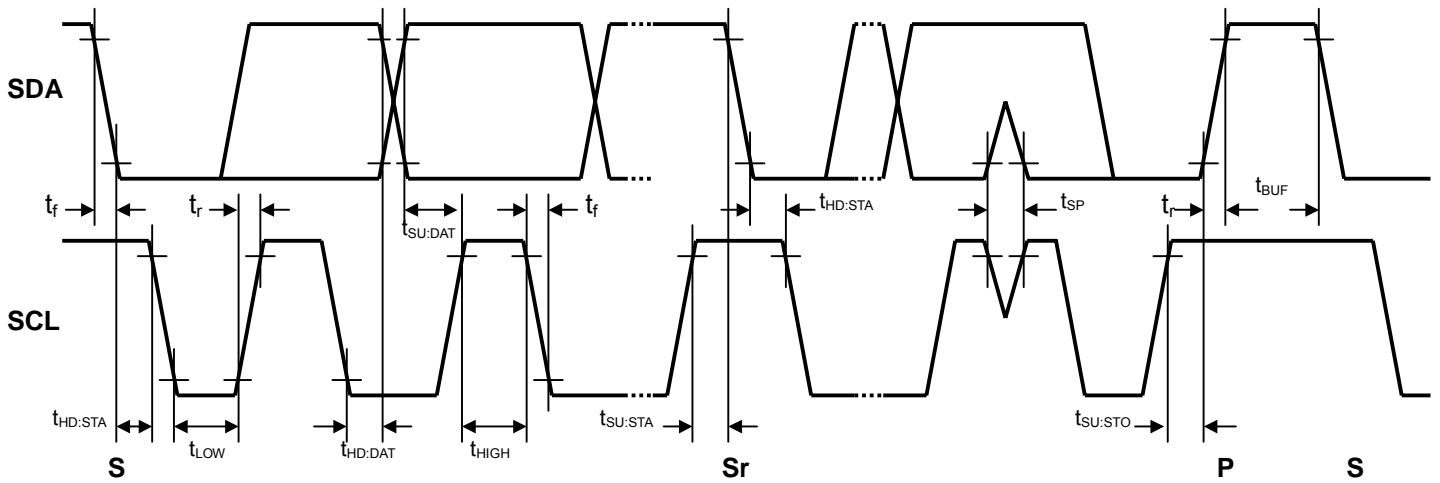

## ■CHARACTERISTICS OF I/O STAGES FOR I<sup>2</sup>C BUS (SDA,SCL)

I<sup>2</sup>C BUS Load Conditions

STANDARD MODE : Pull up resistance 4kΩ (Connected to +5V), Load capacitance 200pF (Connected to GND)

FAST MODE : Pull up resistance 4kΩ (Connected to +5V), Load capacitance 50pF (Connected to GND)

PARAMETER	SYMBOL	Standard mode			Fast mode			UNIT
		MIN.	TYP.	MAX.	MIN.	TYP.	MAX.	
Low Level Input Voltage	V <sub>IL</sub>	0.0	-	1.5	0.0	-	1.5	V
High Level Input Voltage	V <sub>IH</sub>	2.7	-	5.0	2.7	-	5.0	V
Low level output voltage (3mA at SDA pin)	V <sub>OL</sub>	0	-	0.4	0	-	0.4	V
Input current each I/O pin with an input voltage between 0.1V <sub>DD</sub> and 0.9V <sub>DDmax</sub>	I <sub>i</sub>	-10	-	10	-10	-	10	μA

## ■CHARACTERISTICS OF BUS LINES (SDA,SCL) FOR I<sup>2</sup>C-BUS DEVICES

PARAMETER	SYMBOL	Standard mode			Fast mode			UNIT
		MIN.	TYP.	MAX.	MIN.	TYP.	MAX.	
SCL clock frequency	f <sub>SCL</sub>	-	-	100	-	-	400	kHz
Hold time (repeated) START condition.	t <sub>HD:STA</sub>	4.0	-	-	0.6	-	-	μs
Low period of the SCL clock	t <sub>LOW</sub>	4.7	-	-	1.3	-	-	μs
High period of the SCL clock	t <sub>HIGH</sub>	4.0	-	-	0.6	-	-	μs
Set-up time for a repeated START condition	t <sub>SU:STA</sub>	4.7	-	-	0.6	-	-	μs
Data hold time <sup>(NOTE)</sup>	t <sub>HD:DAT</sub>	0	-	-	0	-	-	μs
Data set-up time	t <sub>SU:DAT</sub>	250	-	-	100	-	-	ns
Rise time of both SDA and SCL signals	t <sub>r</sub>	-	-	1000	-	-	300	ns
Fall time of both SDA and SCL signals	t <sub>f</sub>	-	-	300	-	-	300	ns
Set-up time for STOP condition	t <sub>SU:STO</sub>	4.0	-	-	0.6	-	-	μs
Bus free time between a STOP and START condition	t <sub>BUF</sub>	4.7	-	-	1.3	-	-	μs
Capacitive load for each bus line	C <sub>b</sub>	-	-	400	-	-	400	pF
Noise margin at the Low level	V <sub>nL</sub>	0.5	-	-	0.5	-	-	V
Noise margin at the High level	V <sub>nH</sub>	1	-	-	1	-	-	V

C<sub>b</sub> ; total capacitance of one bus line in pF.

NOTE). Data hold time : t<sub>HD:DAT</sub>

Please hold the Data Hold Time (t<sub>HD:DAT</sub>) to 300ns or more to avoid status of unstable at SCL falling edge.

The SDA block in the NJW1184 does not hold data. Add external data-delay-circuit of the SDA terminal, in case of not providing a hold time of at least 300nsec for the SDA in the master device.

The time-consists of the data-delay-circuit of the SDA terminal are as follows.

- (a) Low level → High level :  $T_{LH} \approx R_p \cdot C_D$
- (b) High level → Low level :  $T_{HL} \approx R_D \cdot C_D$

In addition, Schottky barrier diode (SBD) influences a Low level at the Acknowledge. Therefore choose the low forward voltage (V<sub>f</sub>) as much as possible.

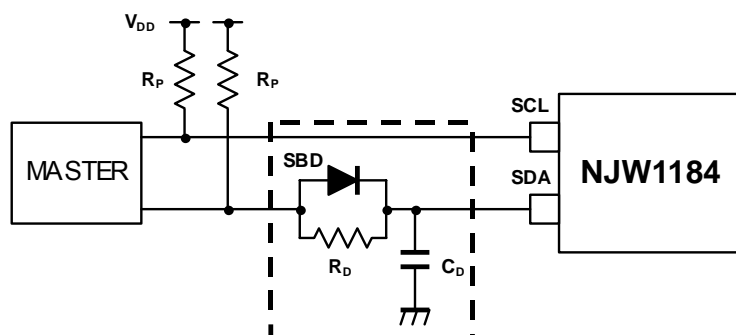

## ■ TERMINAL DESCRIPTION

PIN NO.	SYMBOL	FUNCTION	EQUIVALENT CIRCUIT	TERMINAL DC VOLTAGE
1 3 20 18	IN1 IN2 IN3 IN4	Input 1 Input 2 Input 3 Input 4		$V^+/2$
2 4 19 17	OUT1 OUT2 OUT3 OUT4	Output 1 Output 2 Output 3 Output 4		$V^+/2$
5 6 16 15	CVOL1 CVOL2 CVOL3 CVOL4	DAC Output for Volume 1 DAC Output for Volume 2 DAC Output for Volume 3 DAC Output for Volume 4		$V^+/2 - 0.7V$ (0dB setting)
7	ADR	Slave Address Setting		82(h) $V_{ADR} > V^+/2$  80(h) $V_{ADR} \leq 1.0V$

## ■ TERMINAL DESCRIPTION

PIN NO.	SYMBOL	FUNCTION	EQUIVALENT CIRCUIT	TERMINAL DC VOLTAGE
8 9	SDA SCL	SDA Data Input (I <sup>2</sup> C BUS) SCL Data Input (I <sup>2</sup> C BUS)	<p style="text-align: center;">SCL:GND SDA:ACK</p>	-
12	Vref	Reference Voltage		$V^+/2$
13 14	AUX0 AUX1	Auxiliary Output 0 Auxiliary Output 1		0V / 5V

# NJW1184

## APPLICATION CIRCUIT

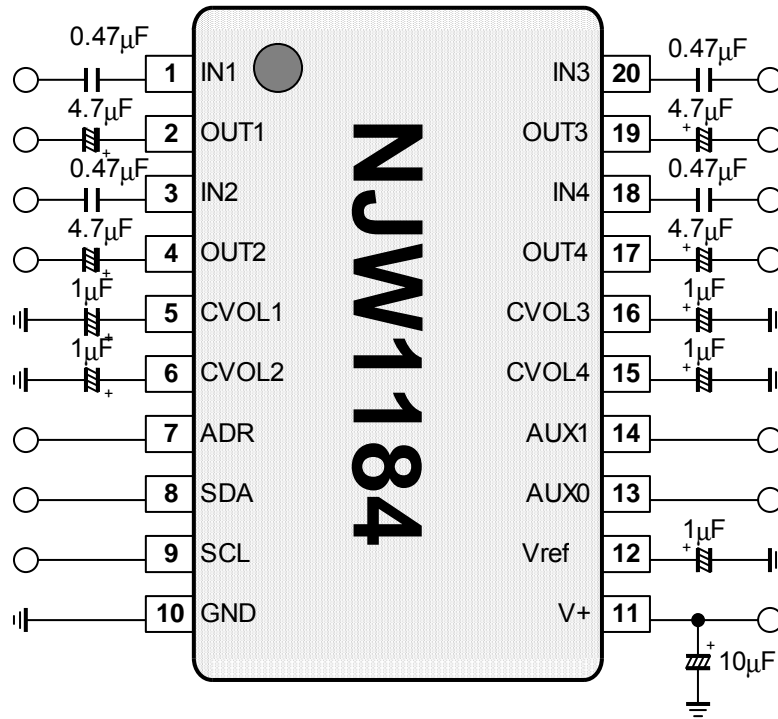



■ DEFINITION OF I<sup>2</sup>C REGISTER

● I<sup>2</sup>C BUS FORMAT

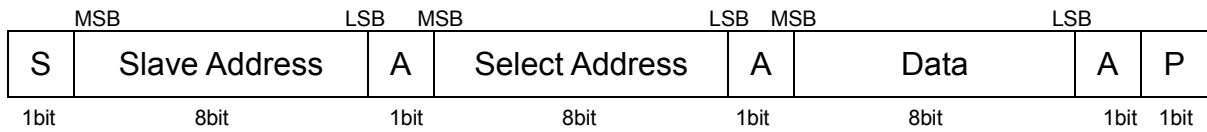

S: Starting Term  
A: Acknowledge Bit  
P: Ending Term

● SLAVE ADDRESS



ADR: Hardware pin programmable address bits  
80(h), 82(h)

R/W=0: Write mode for register setting  
R/W=1: Not available

● CONTROL REGISTER TABLE

The select address sets each function (Volume, Aux).  
The auto-increment function cycles the select address as follows.  
00H→01H→02H→03H→04H→00H

Select Address	BIT							
	D7	D6	D5	D4	D3	D2	D1	D0
00H	VOL-1							
01H	VOL-2							
02H	VOL-3							
03H	VOL-4							
04H	Don't Care	Don't Care	Don't Care	Don't Care	Don't Care	Don't Care	AUX1	AUX0

● CONTROL REGISTER DEFAULT VALUE

Control register default value is all "0".

Select Address	BIT							
	D7	D6	D5	D4	D3	D2	D1	D0
00H	0	0	0	0	0	0	0	0
01H	0	0	0	0	0	0	0	0
02H	0	0	0	0	0	0	0	0
03H	0	0	0	0	0	0	0	0
04H	0	0	0	0	0	0	0	0

## ■ I<sup>2</sup>C CONTROL COMMAND DESCRIPTION

a) Master Volume (Select Address: 00H, 01H, 02H, 03H) Volume level : 0 to -100dB(0.5dB/step), MUTE

Gain(dB)	HEX	VOL-1 / VOL-2 / VOL-3 / VOL-4							
		D7	D6	D5	D4	D3	D2	D1	D0
0	FF	1	1	1	1	1	1	1	1
-0.5	FE	1	1	1	1	1	1	1	0
-1.0	FD	1	1	1	1	1	1	0	1
-1.5	FC	1	1	1	1	1	1	0	0
-2.0	FB	1	1	1	1	1	0	1	1
-2.5	FA	1	1	1	1	1	0	1	0
-3.0	F9	1	1	1	1	1	0	0	1
-3.5	F8	1	1	1	1	1	0	0	0
-4.0	F7	1	1	1	1	0	1	1	1
-4.5	F6	1	1	1	1	0	1	1	0
-5.0	F5	1	1	1	1	0	1	0	1
-5.5	F4	1	1	1	1	0	1	0	0
-6.0	F3	1	1	1	1	0	0	1	1
-6.5	F2	1	1	1	1	0	0	1	0
-7.0	F1	1	1	1	1	0	0	0	1
-7.5	F0	1	1	1	1	0	0	0	0
-8.0	EF	1	1	1	0	1	1	1	1
-8.5	EE	1	1	1	0	1	1	1	0
-9.0	ED	1	1	1	0	1	1	0	1
-9.5	EC	1	1	1	0	1	1	0	0
-10.0	EB	1	1	1	0	1	0	1	1
-10.5	EA	1	1	1	0	1	0	1	0
-11.0	E9	1	1	1	0	1	0	0	1
-11.5	E8	1	1	1	0	1	0	0	0
-12.0	E7	1	1	1	0	0	1	1	1
-12.5	E6	1	1	1	0	0	1	1	0
-13.0	E5	1	1	1	0	0	1	0	1
-13.5	E4	1	1	1	0	0	1	0	0
-14.0	E3	1	1	1	0	0	0	1	1
-14.5	E2	1	1	1	0	0	0	1	0
-15.0	E1	1	1	1	0	0	0	0	1
-15.5	E0	1	1	1	0	0	0	0	0
-16.0	DF	1	1	0	1	1	1	1	1
-16.5	DE	1	1	0	1	1	1	1	0
-17.0	DD	1	1	0	1	1	1	0	1
...	...	...	...	...	...	...	...	...	...
-99.5	38	0	0	1	1	1	0	0	0
-100.0	37	0	0	1	1	0	1	1	1
...	...	...	...	...	...	...	...	...	...
Mute	00	0	0	0	0	0	0	0	0

## b) AUXILIARY SETTING

Select Address	BIT							
	D7	D6	D5	D4	D3	D2	D1	D0
<b>04H</b>	Don't Care	Don't Care	Don't Care	Don't Care	Don't Care	Don't Care	<b>AUX1</b>	<b>AUX0</b>

- AUX1/AUX0: Auxiliary port High/Low
  - “0” : Logic output "Low"
  - “1” : Logic output "High"

## ■ TYPICAL CHARACTERISTICS

**Supply Current vs Temperature**  
 $V+=9V$ ,  $V_{in}$ =No Signal, Volume=0dB

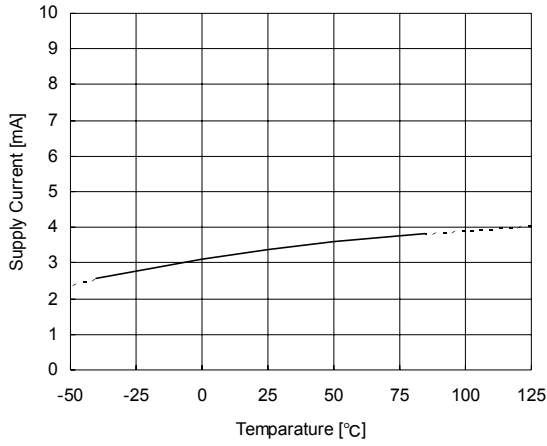

**Reference Voltage vs Temperature**  
 $V+=9V$ ,  $V_{in}$ =No Signal, Volume=0dB

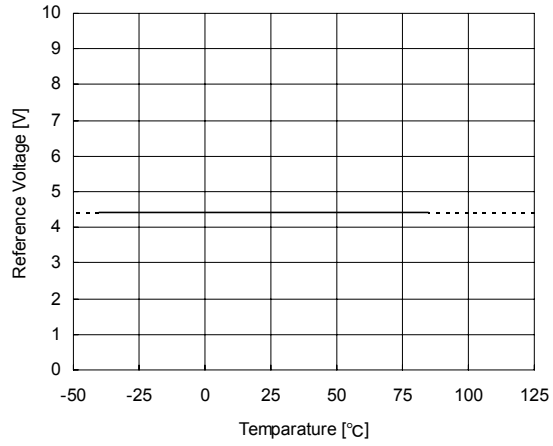

**Supply Current vs Supply Voltage**  
 $V_{in}$ =No Signal, Volume=0dB

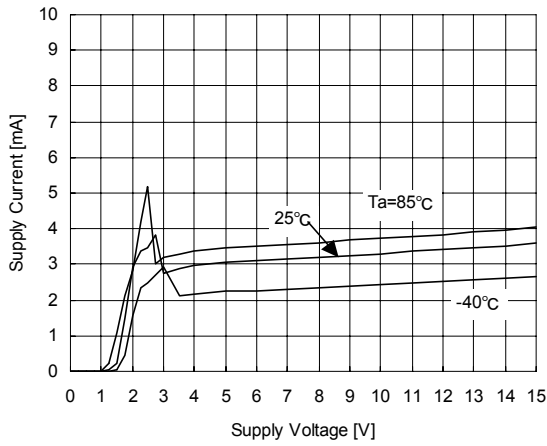

**Reference Voltage vs Supply Voltage**  
 $V_{in}$ =No Signal, Volume=0dB

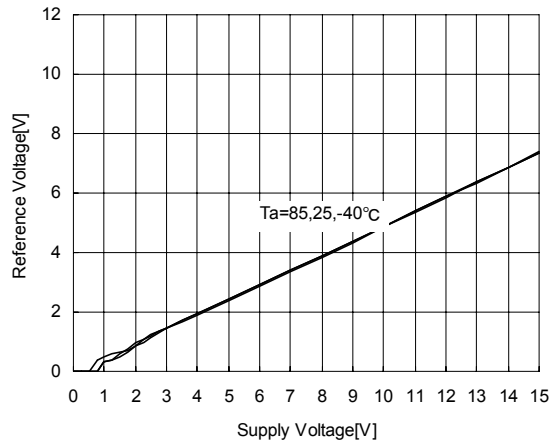

**Out Noise vs Temperature**  
 $V+=9V$ ,  $R_g=600\Omega$ , A-Weighting

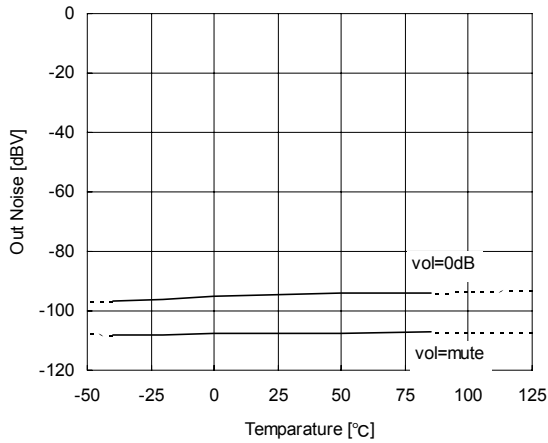

**Mute Level vs Temperature**  
 $V+=9V$ ,  $R_g=600\Omega$ ,  $V_{in}=1V_{rms}$ , A-Weighting

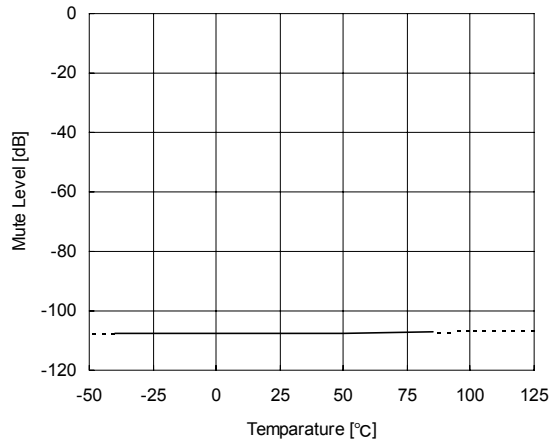

## TYPICAL CHARACTERISTICS

**Channel Separation vs Frequency**

V+=9V, Vin=1Vrms, A-Weighting, Rg=600Ω  
Vin:IN2+IN3+IN4, Vout:OUT1

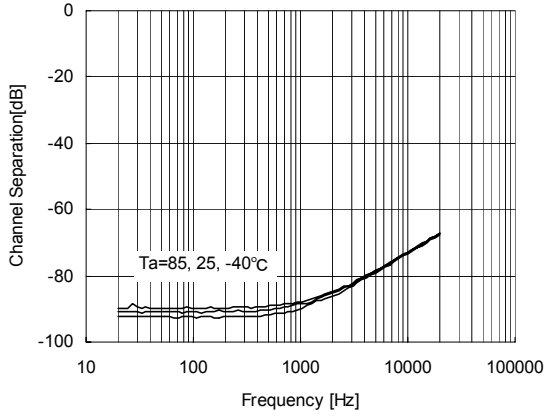

**Channel Separation vs Frequency**

V+=9V, Vin=1Vrms, A-Weighting, Ta=25°C  
Rg=600Ω

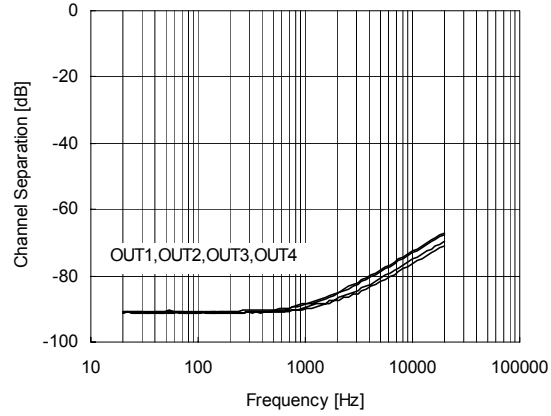

**THD+N vs Input Voltage (Temperature)**

V+=9V, Vin=CH1, f=1kHz, volume=0dB  
Rg=600Ω, BW=400Hz-30kHz, Vout=OUT1

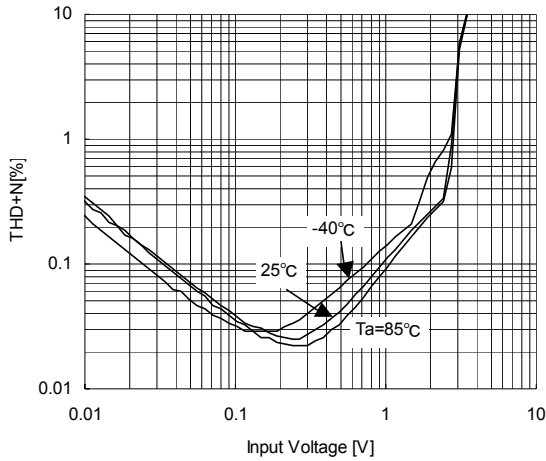

**THD+N vs Input Voltage (Volume Control)**

V+=9V, Vin=CH1, f=1kHz, Ta=25°C  
Rg=600Ω, BW=400Hz-30kHz, Vout=OUT1

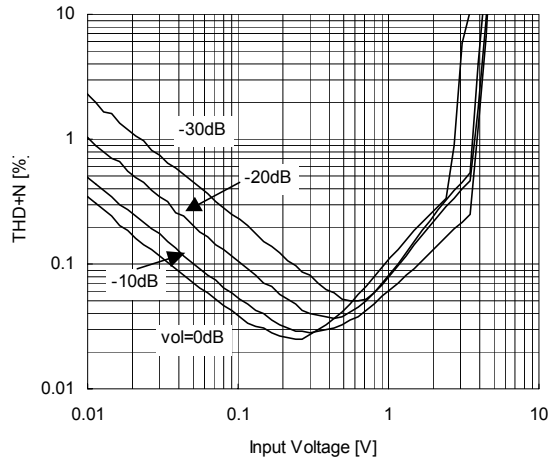

**THD+N vs Output Voltage (Temperature)**

V+=9V, Vin=CH1, f=1kHz, volume=0dB  
Rg=600Ω, BW=400Hz-30kHz, Vout=OUT1

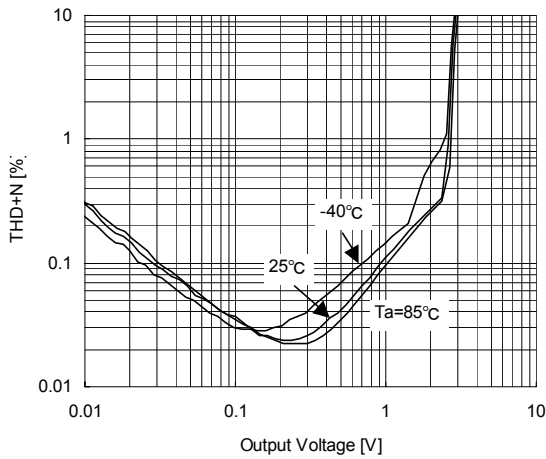

**THD+N vs Output Voltage (Volume Control)**

V+=9V, Vin=CH1, f=1kHz, Ta=25°C  
Rg=600Ω, BW=400Hz-30kHz, Vout=OUT1

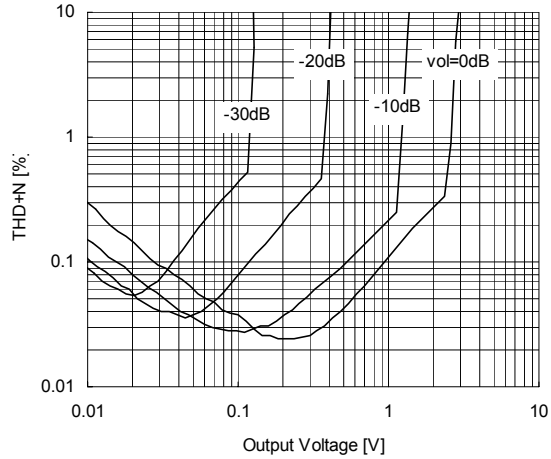

## ■ TYPICAL CHARACTERISTICS

**Gain vs Volume Control (Temperature)**  
 $V+=9V, R_g=600\Omega, V_{in}=1V_{rms}, V_{in}=IN1$

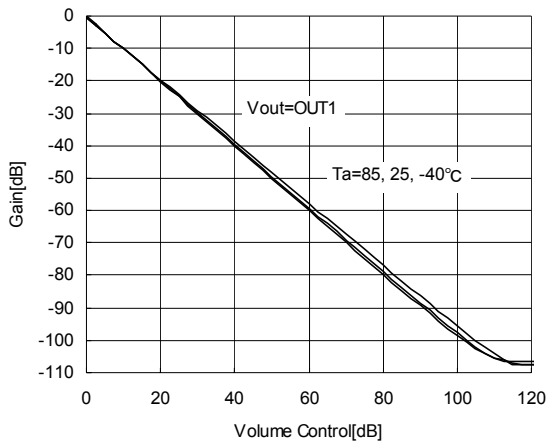

**Gain vs Volume Control**  
 $V+=9V, R_g=600\Omega, V_{in}=1V_{rms}, T_a=25^\circ C$

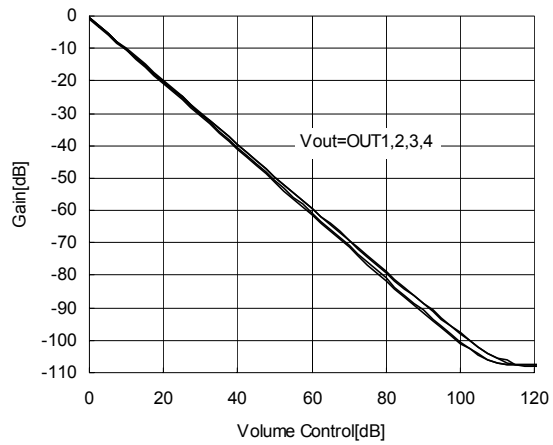

**Channel Balance vs Volume Control (CH1-CH2)**  
 $V_{in}=1V_{rms}, V+=9V$

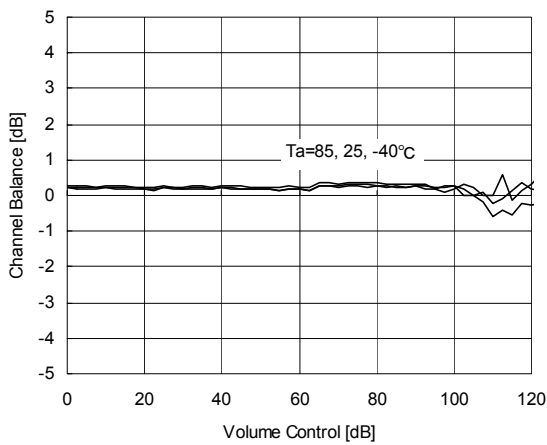

**Channel Balance vs Volume Control (CH3-CH4)**  
 $V_{in}=1V_{rms}, V+=9V$

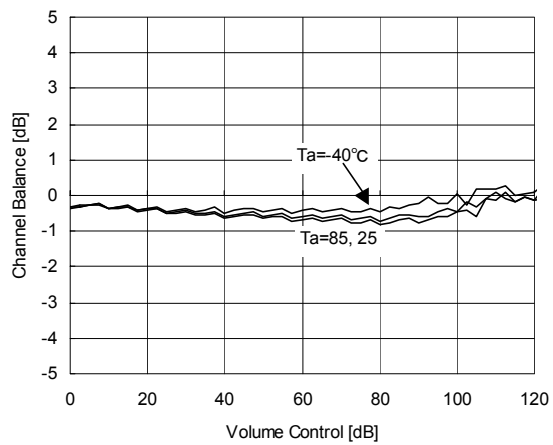

**Maximum Output Voltage vs RL**  
 $V+=9V, THD=1\%$

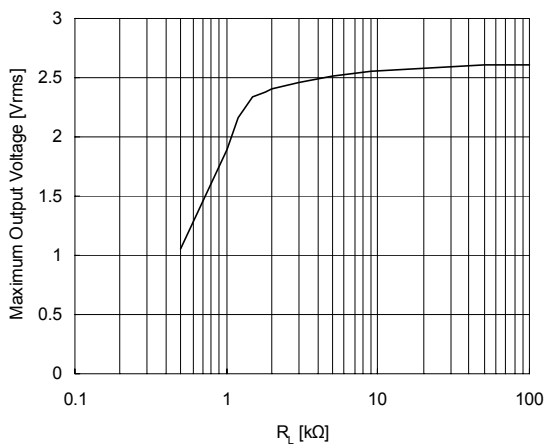

**[CAUTION]**

The specifications on this databook are only given for information, without any guarantee as regards either mistakes or omissions. The application circuits in this databook are described only to show representative usages of the product and not intended for the guarantee or permission of any right including the industrial rights.

# Mouser Electronics

Authorized Distributor

Click to View Pricing, Inventory, Delivery & Lifecycle Information:

[NJR:](#)

[NJW1184M-TE1](#) [NJW1184M-TE2](#) [NJW1184V-TE1](#) [NJW1184M](#)



## Данный компонент на территории Российской Федерации

### Вы можете приобрести в компании MosChip.

Для оперативного оформления запроса Вам необходимо перейти по данной ссылке:

<http://moschip.ru/get-element>

Вы можете разместить у нас заказ для любого Вашего проекта, будь то серийное производство или разработка единичного прибора.

В нашем ассортименте представлены ведущие мировые производители активных и пассивных электронных компонентов.

Нашей специализацией является поставка электронной компонентной базы двойного назначения, продукции таких производителей как XILINX, Intel (ex.ALTERA), Vicor, Microchip, Texas Instruments, Analog Devices, Mini-Circuits, Amphenol, Glenair.

Сотрудничество с глобальными дистрибьюторами электронных компонентов, предоставляет возможность заказывать и получать с международных складов практически любой перечень компонентов в оптимальные для Вас сроки.

На всех этапах разработки и производства наши партнеры могут получить квалифицированную поддержку опытных инженеров.

Система менеджмента качества компании отвечает требованиям в соответствии с ГОСТ Р ИСО 9001, ГОСТ РВ 0015-002 и ЭС РД 009

### Офис по работе с юридическими лицами:

105318, г.Москва, ул.Щербаковская д.3, офис 1107, 1118, ДЦ «Щербаковский»

Телефон: +7 495 668-12-70 (многоканальный)

Факс: +7 495 668-12-70 (доб.304)

E-mail: [info@moschip.ru](mailto:info@moschip.ru)

Skype отдела продаж:

moschip.ru

moschip.ru\_4

moschip.ru\_6

moschip.ru\_9