

NCL30030GEVB

150 W High Performance LED Driver Evaluation Board User's Manual



ON Semiconductor®

www.onsemi.com

EVAL BOARD USER'S MANUAL

Overview

This manual covers the specification, theory of operation, testing and construction of the NCL30030GEVB evaluation board. The NCL30030 board demonstrates a 150 W high performance LED driver intended for commercial/ industrial applications. The NCL30030 combines a CrM PFC boost converter and a QR flyback converter in a single controller. An integrated HV start up is included in the NCL30030.

Table 1. SPECIFICATIONS

| Parameter | Value | Comment |
|--|------------------------|-----------|
| Input voltage (Class 2 Input, no ground) | 90 – 305 V ac | |
| Line Frequency | 50 Hz / 60 Hz | |
| Power Factor (Load > 50%) | 0.9 | |
| THD (Load > 30%) | 20% | Max |
| Class 1 Output Mains Isolated | | |
| Output Voltage Range | 60 – 210 V dc | |
| “Off” Mode CV Output Voltage | 50 V dc | |
| Output Current | 710 mA dc | ±2% |
| Output Ripple | 50 mA P-P | |
| Efficiency | 90% | Typical |
| Start Up Time | < 300 ms | Typical |
| EMI (conducted) | Class A | FCC/CISPR |
| Dimensions | 55 mm × 220 mm × 33 mm | |

Key Features

As illustrated, the key features of this evaluation board include:

- Wide Mains including Support for 277 V ac US Commercial Line Voltage
- Low THD across Line and Load
- High Power Factor across Wide Line and Load
- Remote On/Off (Mains Isolated)
- Integrated Auto-recovery Fault Protection (can be latched by Choice of Options)
 - ◆ On Board Over Temperature Shutdown via NCL30030 Fault Input Pin
 - ◆ LED Module Over Temperature Foldback Input (a remote PTC on LED Array)
 - ◆ Over Voltage
- CC/CV Modes
- Can be Configured for several Dimming Modes
 - ◆ 1 – 10 V dc
 - ◆ 0 – 5 V dc Analog
 - ◆ 0 – 5 V PWM
 - ◆ Bi-level



Figure 1. Evaluation Board Picture (Top View)

THEORY OF OPERATION

PFC

The boost topology is the most common converter type for high performance power factor correction. Since this boost converter operates in CrM, the peak to average input current is always a 2:1 ratio. The converter operates in peak current

control rather than on time control or average current control. CrM boost converters typically have fidelity issues near the zero crossing of the AC line. This is a natural consequence of parasitics in the power stage. See a typical CrM inductor current in Figure 2.

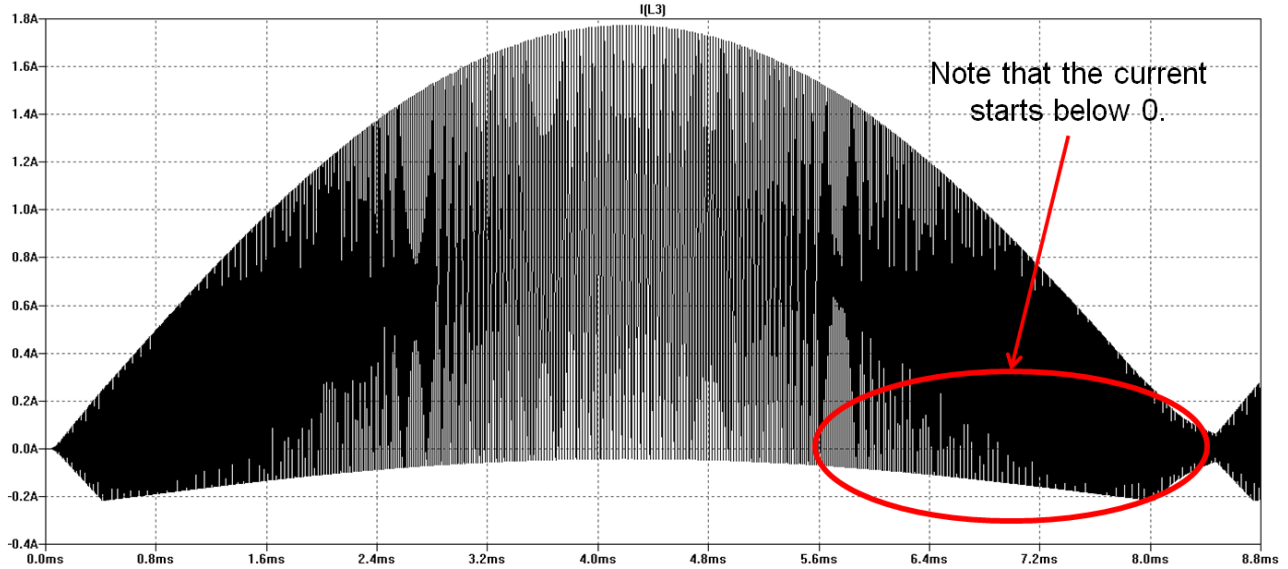

Figure 2. Inductor Current across a Line Cycle

Near the zero crossings, the current starts below zero current. This is a real effect of energy stored in the capacitance of the FET drain that does not get transferred to

the output capacitor. The consequence for on time controllers is that the target peak current is never reached in the on time which results in distortion at the zero crossing.

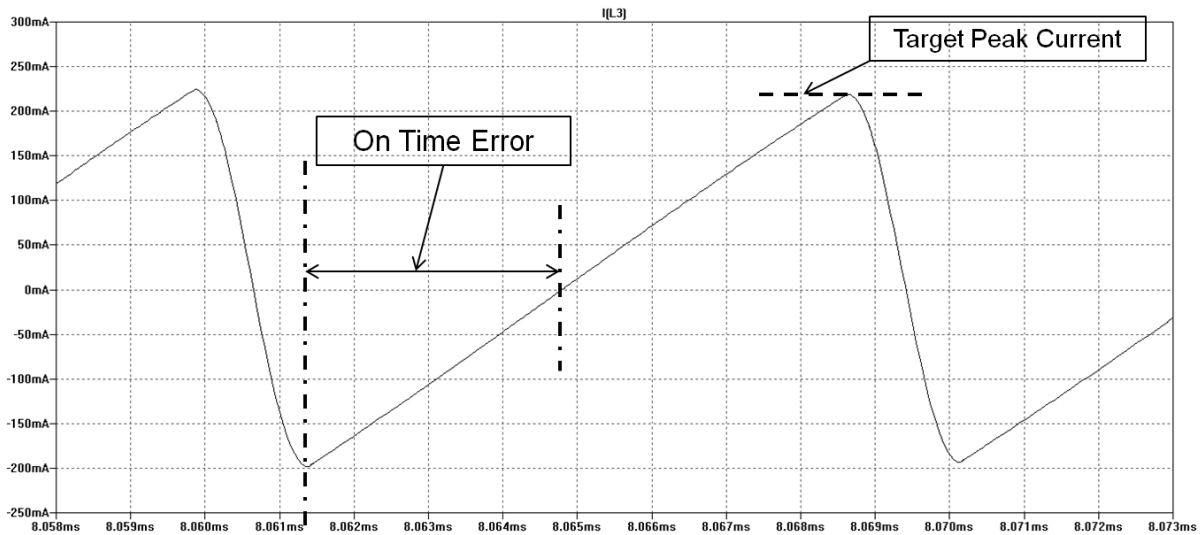

Figure 3. One Switching Cycle of Boost Inductor Current (simulated)

Peak current control corrects the on time error because the on time is dependent on the peak current. This will naturally increase on time at the zero crossing which reduces total harmonic distortion (THD).

The error amplifier adjusts the gain of a PWM multiplier to set the peak current threshold in the controller. The

multiplier output needs to be filtered to recover the scaled current threshold signal. The value of the filter capacitor is critical to obtain good THD over the entire line range. The filter capacitor must be large enough to filter the PWM carrier frequency but not so large as to cause excess phase lag which will degrade the THD.

Bi-Level Boost Follower

The HV pin provides start up current for the controller and sense the HVDC voltage. The boost output reference for the control loop is adjusted based on the input voltage. There are 3 options for this: 2:1, 1.77:1, and 1:1 (i.e. fixed output voltage). This allows the boost converter to operate most efficiently over a broad range of input voltages.

Current Sense and ZCD

The current sense and ZCD are combined on one pin as illustrated in Figure 5. During the switch on time, the peak current is sensed through R24. D11 blocks the negative voltage from the sense winding from affecting the current sense. During the off time, D11 forward biases and pull the pin high through R26. Collapsing voltage on the boost inductor signals that the current has gone to zero and starts a new switch cycle.

Flyback

The flyback converter isolates the output from the mains and provides power for the secondary side control. For this specific design given the high output voltage of the PFC Bus rail and the high voltage range of the output, a two switch flyback configuration was selected. The two switch operation for the flyback optimizes efficiency because the leakage energy is recycled back to the primary energy storage. One limitation of the two switch flyback is that the reflected output voltage must be less than the input voltage otherwise all of the stored energy in the transformer will be returned to the input energy storage. Since the turns ratio is 1:1 and the maximum output voltage is 210 V, that condition is satisfied.

The converter operates in quasi-resonant mode. At heavy loads, the turn on edge is timed to the first valley like CrM mode. At progressively lighter loads, the controller moves the turn on edge to progressively higher order valleys. The voltage on the control determines the valley of operation. There are several important benefits of this technique.

1. The frequency is more stable over the load range
2. The peak current remains higher across load as the switching frequency is reduced. This keeps the signal-to-noise ratio high on the CS pin.

Feedback Control

The NCL30030 has no internal error amplifier for the flyback control. The feedback pin directly programs the peak current and sets the valley selection. There is a current source that pulls up the FB pin. Consequently, the control is setup for secondary side feedback only.

Connections to the Evaluation Board

There are several connections necessary to operate the evaluation board.

- AC Input – J1 3 Pin Connector
 1. AC Line
 2. nc
 3. AC Neutral
- LED Output – J2 3 Pin Connector
 1. LED +
 2. nc
 3. LED–
- Control – J3 7 Pin Connector
 1. 10 V
 2. 1–10 V Dimming
 3. 0–5 V Analog or Digital PWM Dimming
 4. Lamp TCO
 5. Bi-level Dimming
 6. On–Off
 7. Common

Control Connections

10V

This connection provides a current limited 10 V source which can be used to power the dimming interface. Current is limited to 10 mA through a 1 k Ω resistor.

LED Lamp TCO

The LED assembly may have a PTC that “opens” when the LED assembly exceeds a safe temperature. The cold value of the PTC should be approximately 470 Ω and the transition resistance should be greater than 5 k Ω . The action of the TCO folds back the output current to maintain the temperature at a safe level but does not turn the LEDs completely off.

NOTE: Connect the Lamp TCO connection to common if a TCO is not used.

On–Off

The driver can be turned “off” from the secondary side. An open on the on–off connection defaults to “off”. Connect the on–off connection to common to turn on the driver. Off mode operates the output in a low voltage (50 V) CV mode such that the output voltage is below the LED operational voltage.

Dimming Control Mode Setup

The evaluation board can be configured to support numerous dimming configurations; only one type of dimming is supported at a time. In addition to a 1–10 V Dimming interface, analog, digital and bi-level options are supported. Bi-level can be used in conjunction with motion sensors or timers to provide two light output levels depending on the use case.

Table 2. CONFIGURING THE BOARD FOR DIMMING CONTROL

| Connection | Mode | | | |
|-----------------|-------------------------|----------------------|--|--|
| | 1 – 10 V | 0 – 5 V Analog | 0 – 5 V Digital | Bi-Level |
| 1 – 10 V | 1 – 10 V Analog Voltage | Open | | Open |
| 0 – 5 V Analog | Open | 0 – 5 Analog Voltage | N/A | Open |
| 0 – 5 V Digital | | N/A | 0 – 5 V Digital Input Freq > 400 Hz | Open |
| Bi-level | Open | Open | | Open = High Current GND = Low Current |

Modifications

It is possible for the user to select different operating conditions for the evaluation board such as output current, over voltage threshold, and over temperature threshold.

Output Current

R9 and R44 set the output current. R44 is a trim resistor to make fine adjustments to the current set point. The reference voltage for U2 is 62.5 mV. I_{output} is calculated as follows:

$$I_{output} = \frac{62.5 \text{ mV} \times (R9 + R44)}{R9 \times R44}$$

The low reference voltage makes even the copper PCB trace resistance important in setting the output current. There are limitations to setting the current without making major component changes. Generally the current can be adjusted from 0.5 A – 1.0 A.

CV Regulation

As illustrated in Figure 7, the NCP4328A (U2) also serves as the CV regulator loop control. R12, R13, R14, and R28 set the CV output. As built, the evaluation board CV point is 210 V dc. The reference voltage for the CV loop is 1.25 V. R13 and R28 are in parallel. Their equivalent resistance is:

$$R_{eq} = \frac{R13 \times R28}{R13 + R28}$$

CV regulation is calculated as follows:

$$CV = \frac{R13 + R_{eq} + R14}{R_{eq}} \times 1.25 \text{ V}$$

Over Voltage Protection

Zener D19 is used to set the primary side over voltage fault protection level. As built, the CV loop will prevent an OV fault under normal circumstances. D19 pulls up the fault pin on U1 to trigger a fault. The fault shuts down U1 for 4 seconds and then recycles the fault latch. A non-resetting latch is an option for U1. The set point for the trip point is calculated as follows:

$$OV = \frac{V_{d19}}{30\%}$$

D19 must be replaced to change the OV threshold.

Thermal Protection

The evaluation board has an onboard thermal shutdown utilizing the NTC R3 connected to the fault pin of U1. As R3 heats, the output current will shut off until the NTC cools down. R3 can be replaced with a fixed resistor if no thermal protection is desired.

NCL30030EVB

SCHEMATIC

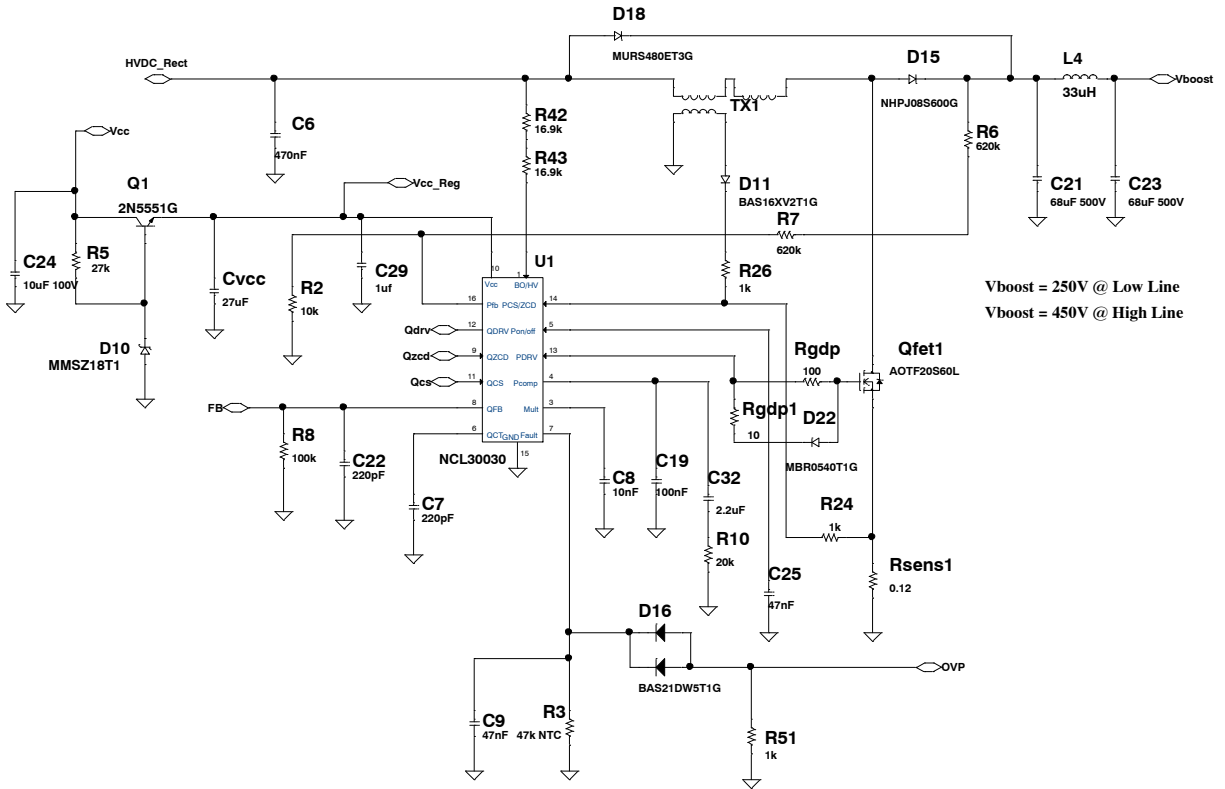
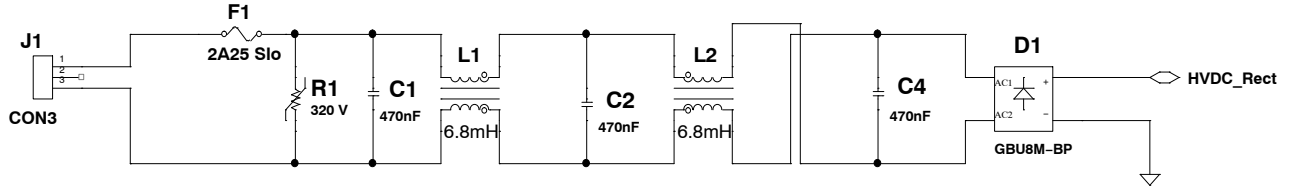

NCL30030GEVB

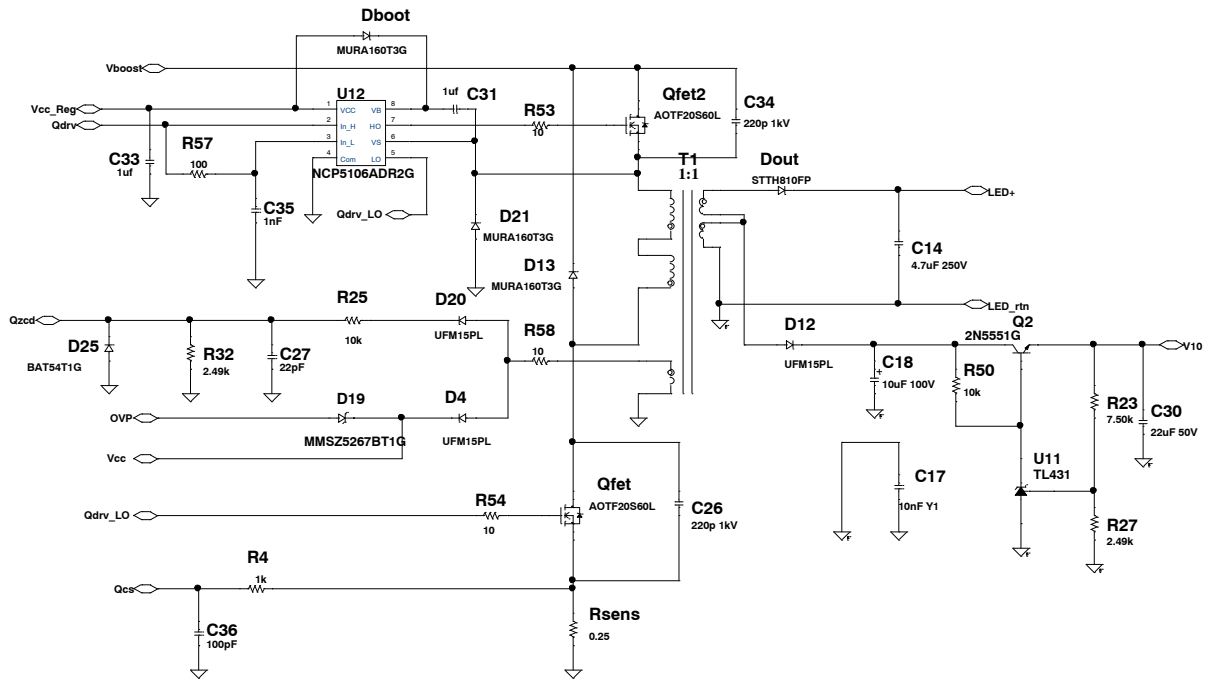

Figure 6. Flyback Schematic

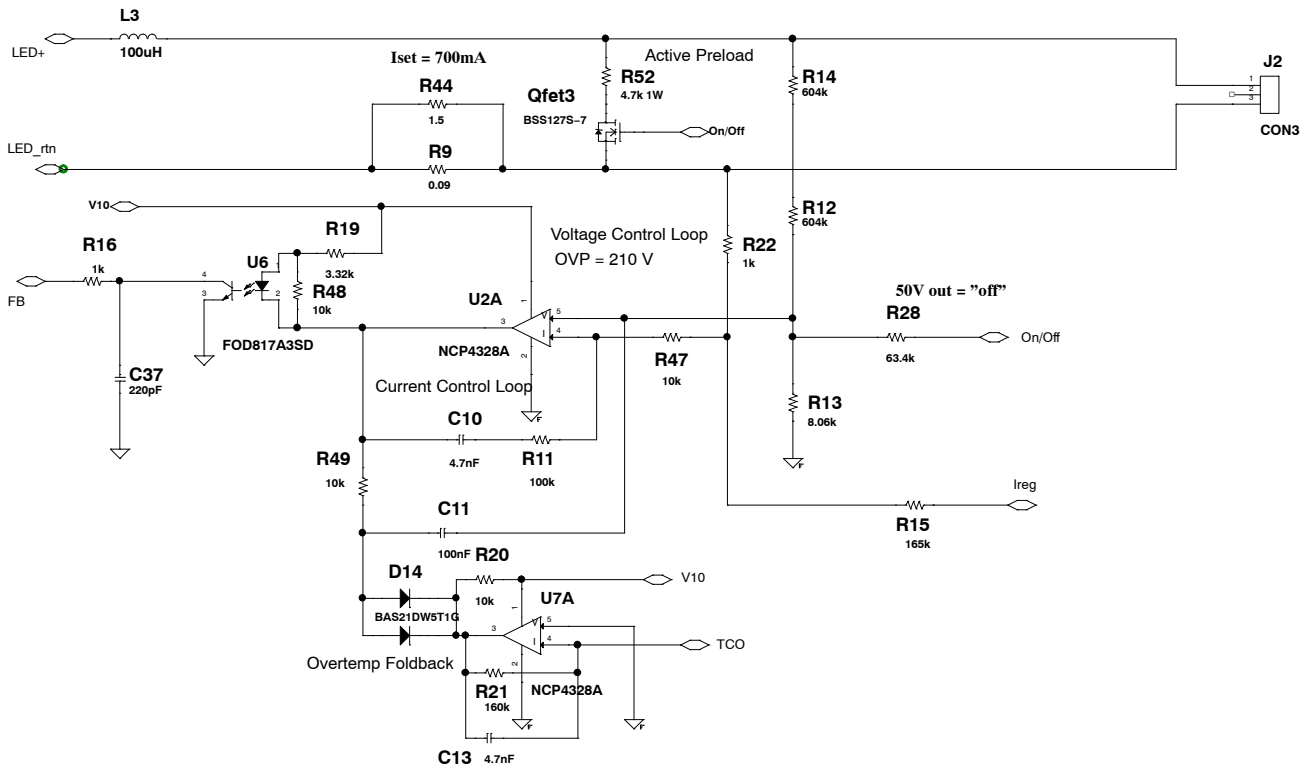

Figure 7. Control Schematic

NCL30030GEVB

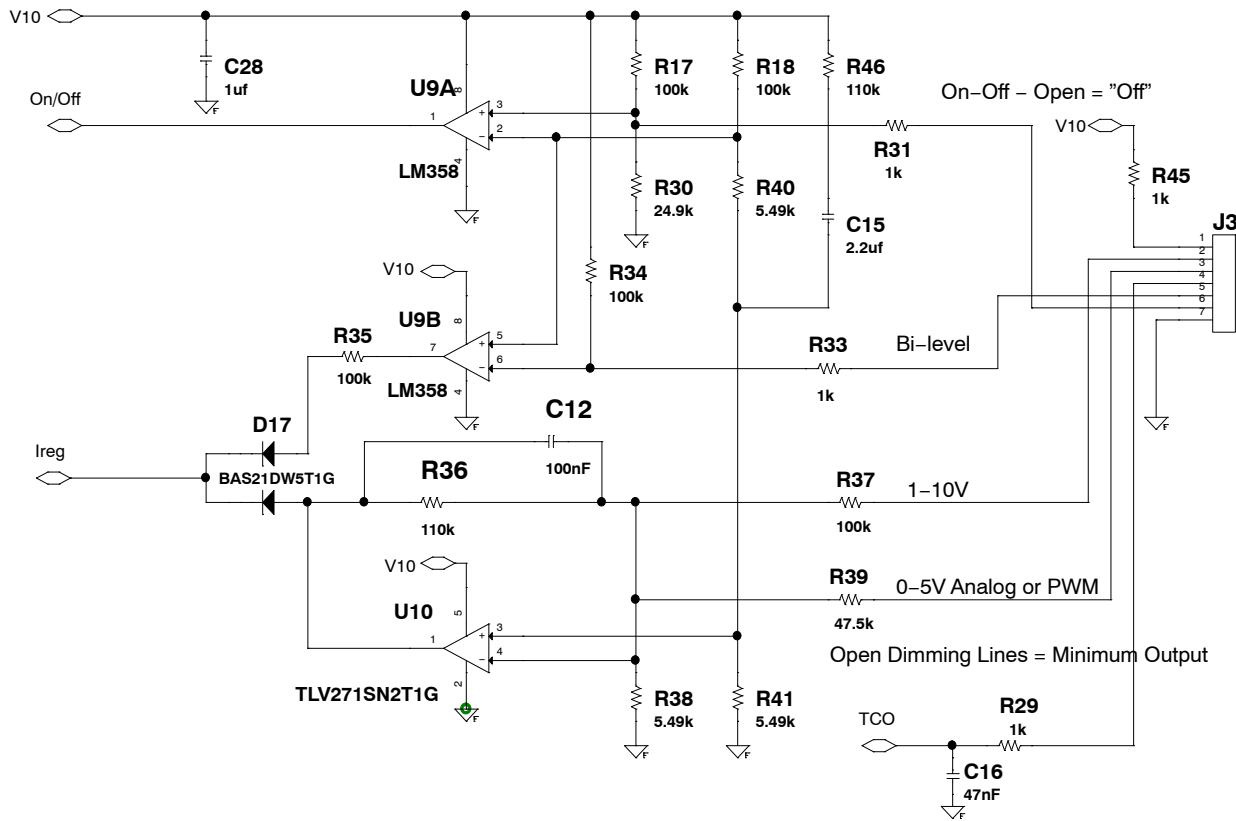

Figure 8. Dimming Interface

BILL OF MATERIAL

Table 3. BILL OF MATERIAL*

| Qty | Reference | Part | Manufacturer | Mfr_PN | PCB Footprint | Substitutions Allowed |
|-----|------------------|------------|--------------|-------------------|------------------------|-----------------------|
| 1 | Cvcc | 27uF | Panasonic | EEU-FC1E270 | CAP_AL_5X11 | Yes |
| 4 | C1,C2,C4, C6 | 470nF | Epcos | B32923C3474K | CAP-BOX-LS22M5-26MX7M | Yes |
| 3 | C7,C22, C37 | 220pF | Yageo | CC0805JRNPO9BN221 | 805 | Yes |
| 1 | C8 | 10nF | AVX | 0805YA103JAT2A | 805 | Yes |
| 3 | C9,C16, C25 | 47nF | Yageo | CC0805KRX7R9BB473 | 805 | Yes |
| 2 | C10,C13 | 4.7nF | Yageo | CC0805KRX7R9BB472 | 805 | Yes |
| 3 | C11,C12, C19 | 100nF | Yageo | CC0805KRX7R9BB104 | 805 | Yes |
| 1 | C14 | 4.7uF 250V | Panasonic | ECQ-E2475KB | CAP-BOX-LS175-8M5X18 | Yes |
| 1 | C15 | 2.2uf | Taiyo Yuden | UMK212BB7225KG-T | 805 | Yes |
| 1 | C17 | 10nF Y1 | Vishay | 440LS10-R | Cap_disc_20mm | Yes |
| 2 | C18,C24 | 10uF 100V | Rubycon | 100PK10MEFC5X11 | CAP_AL_5X11 | Yes |
| 1 | C21 | 68uF 500V | Nichicon | UCY2H680MHD | CAP-ALEL-18X42-HOR-REV | Yes |
| 1 | C23 | 68uF 500V | Nichicon | UCY2H680MHD | CAP-ALEL-18X42-HOR | Yes |
| 2 | C26,C34 | 220p 1kV | Kemet | R76QD0220SE00J | CAP-BOX-LS5-3M5X7M2 | Yes |
| 1 | C27 | 22pF | Yageo | CC0805JRNPO9BN220 | 805 | Yes |
| 4 | C28,C29, C31,C33 | 1uf | Yageo | CC0805KKX7R8BB105 | 805 | Yes |
| 1 | C30 | 22uF 50V | Rubycon | 50YXM22MEFC5X11 | CAP_AL_5X11 | Yes |
| 1 | C32 | 2.2uF | Yageo | CC0805KKX7R6BB225 | 805 | Yes |

*All Components to be RoHS Compliant

NCL30030GEVB

Table 3. BILL OF MATERIAL*

| Qty | Reference | Part | Manufacturer | Mfr_PN | PCB Footprint | Substitutions Allowed |
|-----|---|--------------|------------------|-------------------|----------------|-----------------------|
| 1 | C35 | 1nF | Yageo | CC0805JRNPO9BN102 | 805 | Yes |
| 1 | C36 | 100pF | Yageo | CC0805JRNPO9BN101 | 805 | Yes |
| 3 | D13,D21, Dboot | MURA160T3G | ON Semiconductor | MURA160T3G | SMA | No |
| 1 | Dout | STTH810FP | ST | STTH810FP | TO-220-2_vert | Yes |
| 1 | D1 | GBU8M-BP | MCC | GBU8M-BP | 4P_inline | Yes |
| 3 | D4,D12, D20 | UFM15PL | MCC | UFM15PL | SOD123FL | Yes |
| 1 | D10 | MMSZ18T1 | ON Semiconductor | MMSZ18T1 | SOD123FL | No |
| 1 | D11 | BAS16XV2T1G | ON Semiconductor | BAS16XV2T1G | SOD523 | No |
| 3 | D14,D16, D17 | BAS21DW5T1G | ON Semiconductor | BAS21DW5T1G | SC-88A | No |
| 1 | D15 | NHPJ08S600G | ON Semiconductor | NHPJ08S600G | TO-220-UP | No |
| 1 | D18 | MURS480ET3G | ON Semiconductor | MURS480ET3G | SMC | No |
| 1 | D19 | MMSZ5267BT1G | ON Semiconductor | MMSZ5267BT1G | SOD123FL | No |
| 1 | D22 | MBR0540T1G | ON Semiconductor | MBR0540T1G | SOD123FL | No |
| 1 | D25 | BAT54T1G | ON Semiconductor | BAT54T1G | SOD123FL | No |
| 1 | F1 | 2A25 Slo | Littelfuse | 02092.25MXEP | 15mm_axial | Yes |
| 2 | J1,J2 | CON3 | Würth | 6.91E+11 | Conn_3P_Scrmnt | Yes |
| 1 | J3 | CON7 | On Shore | OSTTA074163 | Conn_7P_Scrmnt | Yes |
| 2 | L1,L2 | 6.8mH | Würth | 7.5E+08 | HOR-4P-19X10 | Yes |
| 1 | L3 | 100uH | Würth | 7.45E+08 | Rad_Ind_LS5 | Yes |
| 1 | L4 | 33uH | Würth | 7.45E+08 | Rad_Ind_LS5 | Yes |
| 3 | Qfet1,Qfet2, Qfet | AOTF20S60L | AOS | AOTF20S60L | TO-220-3-Vert | Yes |
| 1 | Qfet3 | BSS127S-7 | Diodes | BSS127S-7 | SOT23 | Yes |
| 2 | Q1,Q2 | 2N5551G | ON Semiconductor | 2N5551G | TO92 | No |
| 2 | R57,Rgdp | 100 | Yaego | RC0805FR-07100RL | 805 | Yes |
| 4 | Rgdp1,R53, R54,R58 | 10 | Yaego | RC0805FR-0710RL | 805 | Yes |
| 1 | Rsens | 0.25 | Vishay | WSL2512R2500FEA | 2512 | Yes |
| 1 | Rsens1 | 0.12 | Yaego | RL2512FK-070R12L | 2512 | Yes |
| 1 | R1 | 320 V | Epcos | S20K320E2 | MOV_20mm_disc | Yes |
| 6 | R2,R20, R25,R47, R48,R49 | 10k | Yaego | RC0805FR-0710KL | 805 | Yes |
| 1 | R3 | 47k NTC | Epcos | B57431V2473J62 | 805 | Yes |
| 10 | R4,R16,R22,R24, R26,R29, R31,R33, R45,R51 | 1k | Yaego | RC0805FR-071KL | 805 | Yes |
| 1 | R5 | 27k | Yaego | RC0805FR-0727KL | 805 | Yes |
| 2 | R6,R7 | 620k | Yageo | RC1206FR-07620KL | 1206 | Yes |
| 7 | R8,R11, R17,R18, R34,R35, R37 | 100k | Yaego | RC0805FR-07100KL | 805 | Yes |
| 1 | R9 | 0.09 | Vishay | WSL1206R0900FEA | 1206 | Yes |
| 1 | R10 | 20k | Yaego | RC0805FR-0720KL | 805 | Yes |
| 2 | R12,R14 | 604k | Yageo | RC1206FR-07604KL | 1206 | Yes |
| 1 | R13 | 8.06k | Yaego | RC0805FR-078K06L | 805 | Yes |
| 1 | R15 | 165k | Yaego | RC0805FR-07165KL | 805 | Yes |
| 1 | R19 | 3.32k | Yaego | RC0805FR-073K32L | 805 | Yes |
| 1 | R21 | 160k | Yaego | RC0805FR-07160KL | 805 | Yes |
| 1 | R23 | 7.50k | Yaego | RC0805FR-077K5L | 805 | Yes |
| 2 | R27,R32 | 2.49k | Yaego | RC0805FR-072K49L | 805 | Yes |

*All Components to be RoHS Compliant

NCL30030GEVB

Table 3. BILL OF MATERIAL*

| Qty | Reference | Part | Manufacturer | Mfr_PN | PCB Footprint | Substitutions Allowed |
|-----|--------------|--------------|------------------|------------------|---------------|-----------------------|
| 1 | R28 | 63.4k | Yaego | RC0805FR-0763K4L | 805 | Yes |
| 1 | R30 | 24.9k | Yaego | RC0805FR-0724k9L | 805 | Yes |
| 2 | R36,R46 | 110k | Yaego | RC0805FR-07110KL | 805 | Yes |
| 3 | R38,R40, R41 | 5.49k | Yaego | RC0805FR-075K49L | 805 | Yes |
| 1 | R39 | 47.5k | Yaego | RC0805FR-0747K5L | 805 | Yes |
| 2 | R42,R43 | 16.9k | Yaego | RC1206FR-0716K9L | 1206 | Yes |
| 1 | R44 | 1.5 | Yaego | RC1206FR-071R5L | 1206 | Yes |
| 1 | R50 | 10k | Yaego | RC1206FR-0710KL | 1206 | Yes |
| 1 | R52 | 4.7k 1W | Yaego | RSF100JB-73-4K7 | 15MM_Axial | Yes |
| 1 | TX1 | XFRM_LINEAR | Würth | 7.5E+08 | PQ2625-X12 | Yes |
| 1 | T1 | XFRM_LINEAR | Würth | 750314657 Rev3 | ER2817 | Yes |
| 1 | U1 | NCL30030 | ON Semiconductor | NCL30030B1DR2G | SO16-P2 | No |
| 2 | U2,U7 | NCP4328A | ON Semiconductor | NCP4328A | TSOP-5 | No |
| 1 | U6 | FOD817A3SD | Fairchild | FOD817A3SD | 4SMD | Yes |
| 1 | U9 | LM358 | ON Semiconductor | LM358DR2G | SO8M1 | No |
| 1 | U10 | TLV271SN2T1G | ON Semiconductor | TLV271SN2T1G | SOT23-5 | No |
| 1 | U11 | TL431 | ON Semiconductor | TL431ACLPRAG | TO92 | No |
| 1 | U12 | NCP5106ADR2G | ON Semiconductor | NCP5106ADR2G | SO8M1 | No |

*All Components to be RoHS Compliant

NCL30030GEVB

GERBER VIEWS

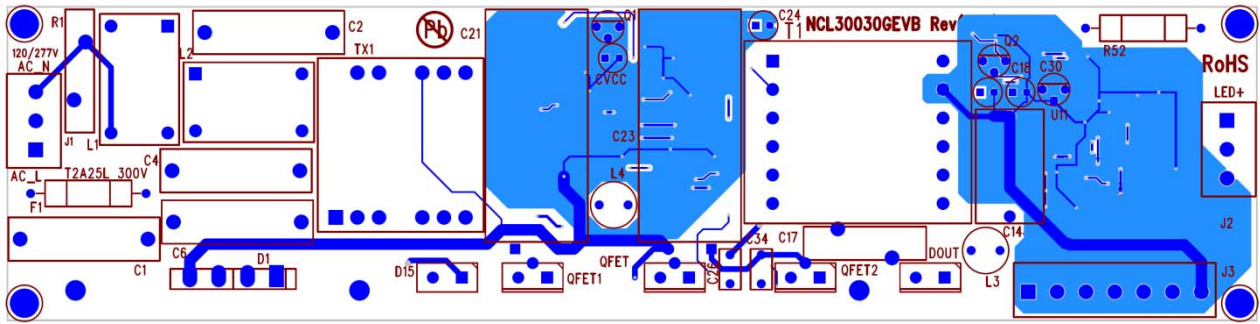

Figure 9. Top Side PCB

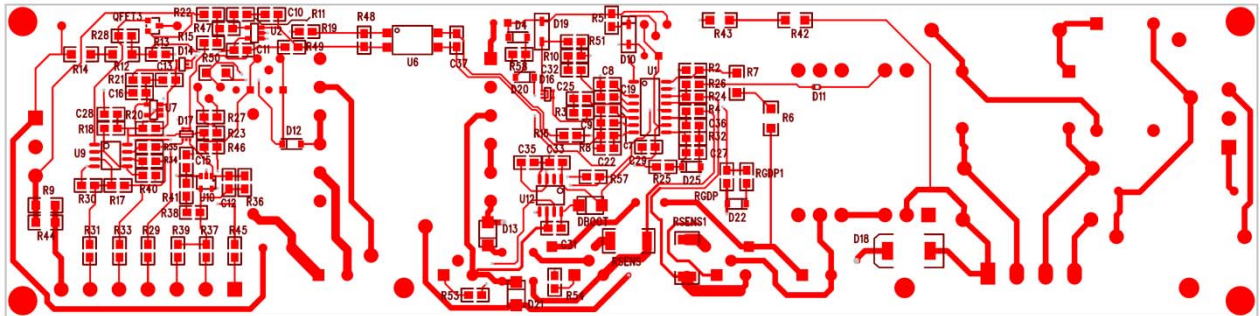

Figure 10. Bottom Side PCB

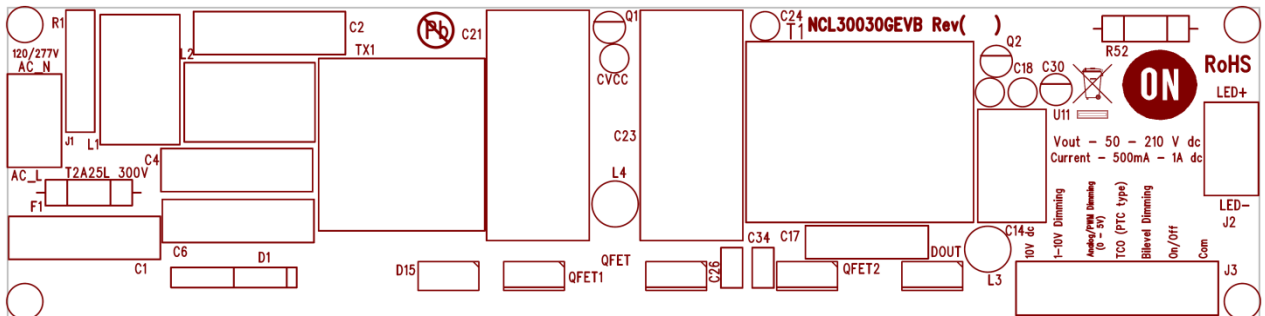

Figure 11. Top Silkscreen



Figure 12. Bottom Silkscreen

CIRCUIT BOARD FABRICATION NOTES

1. Fabricate per IPC-6011 and IPC6012. Inspect to IPA-A-600 Class 2 or updated standard.
2. Printed Circuit Board is defined by files listed in fileset.
3. Modification to copper within the PCB outline is not allowed without permission, except where noted otherwise. The manufacturer may make adjustments to compensate for manufacturing process, but the final PCB is required to reflect the associated gerber file design ± 0.001 in. for etched features within the PCB outline.
4. Material in accordance with IPC-4101/21, FR4, Tg 125°C min.
5. Layer to layer registration shall not exceed ± 0.004 in.
6. External finished copper conductor thickness shall be 0.0026 in. min. (ie 2oz)
7. Copper plating thickness for through holes shall be 0.0013 in. min. (ie 1oz)
8. All holes sizes are finished hole size.
9. Finished PCB thickness 0.062 in.
10. All un-dimensioned holes to be drilled using the NC drill data.
11. Size tolerance of plated holes: ± 0.003 in. : non-plated holes ± 0.002 in.
12. All holes shall be ± 0.003 in. of their true position U.D.S.
13. Construction to be SMOBC, using liquid photo image (LPI) solder mask in accordance with IPC-SM-B40C, Type B, Class 2, and be green in color.
14. Solder mask mis-registration ± 0.004 in. max.
15. Silkscreen shall be permanent non-conductive white ink.
16. The fabrication process shall be UL approved and the PCB shall have a flammability rating of UL94V0 to be marked on the solder side in silkscreen with date, manufactures approved logo, and type designation.
17. Warp and twist of the PCB shall not exceed 0.0075 in. per in.
18. 100% electrical verification required.
19. Surface finish: electroless nickel immersion gold (ENIG)
20. RoHS compliance required.

NCL30030GEVB

FLYBACK TRANSFORMER SPECIFICATION

| | | | |
|-------------------|------|---------------|---|
| CUSTOMER TERMINAL | RoHS | LEAD(Pb)-FREE |  |
| Sn96%, Ag4% | Yes | Yes | |

PART MUST INSERT FULLY TO SURFACE A IN RECOMMENDED GRID

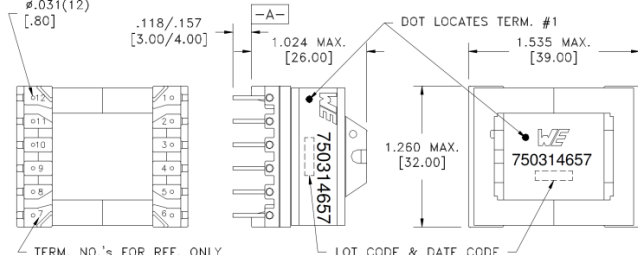

TERM. NO.'s FOR REF. ONLY

LOT CODE & DATE CODE

ALTERNATE MARKING DETAIL

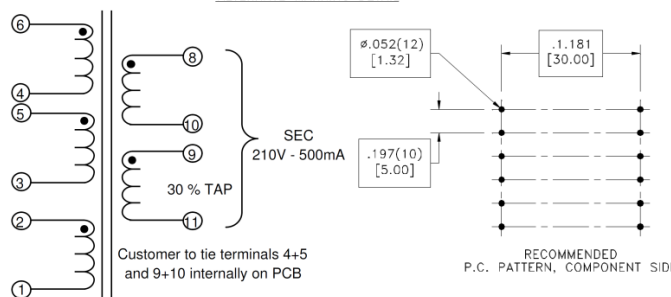

PRI
250-450V
100kHz

AUX

SEC
210V - 500mA

30% TAP

Customer to tie terminals 4+5 and 9+10 internally on PCB

RECOMMENDED P.C. PATTERN, COMPONENT SIDE

ELECTRICAL SPECIFICATIONS @ 25°C unless otherwise noted:

D.C. RESISTANCE (@20°C):

- 1-2, 0.160 Ohms ±10%.
- 3-6 (tie 4+5), 0.170 Ohms ±10%.
- 8-11 (tie 9+10), 0.130 Ohms ±10%.
- 9-11, 0.045 Ohms ±20%.

DIELECTRIC RATING:

- 3000VAC, 1 minute tested by applying 3750VAC for 1 second between pins 1-11(tie 2+3+4, 9+10).
- 500VAC, 1 minute tested by applying 625VAC for 1 second between pins 1-6(tie 4+5).

INDUCTANCE:

- 425 µH ±10%, 10kHz, 100mVAC, 0mADC, 3-6(tie 4+5), Ls.

SATURATION CURRENT:

- 3.3A saturating current that causes 20% rolloff from initial inductance.

LEAKAGE INDUCTANCE:

- 8µH typ, 15µH max, 100kHz, 100mVAC, 3-6(tie 4+5, 8+9+10+11), Ls.

URNS RATIO:

- (6-4):(5-3), (1):(1.00), ±1%.
- (6-3):(2-1), (3.29):(1.00), tie(4+5), ±1%.
- (6-3):(9-11), (3.29):(1.00), tie(4+5), ±1%.
- (6-3):(8-11), (1):(1.00), tie(4+5, 9+10), ±1%.

Designed to comply with the following requirements as defined by IEC60950-1, EN60950-1, UL60950-1/CSA60950-1 and AS/NZS60950.1:

- Reinforced insulation for a primary circuit at a working voltage of 450VDC.

OPERATING TEMPERATURE RANGE: -40°C to 125°C including temp. rise.

Wire insulation & RoHS status not affected by wire color. Wire insulation color may vary depending on availability.

| | | | |
|--|--|---|--|
| Wurth Electronics Midcom Inc. Watertown, SD USA Toll Free: 800-643-2661 Fax: 605-886-4486 | Unless otherwise specified, tolerances are as follows: Angles: ±1° Fractions: ±1/64 Decimals: ±.005(-.127mm) Footprint: ±.001(.03mm) | more than you expect | |
| | Drawing Title <h3 style="margin: 0;">Transformer</h3> | Drawing Number <h3 style="margin: 0;">750314657</h3> | Rev. <h3 style="margin: 0;">03</h3> |
| This drawing is dual dimensioned. Dimensions in brackets are in millimeters | Revisions: See Sheet 1 | Scale ---- | Spec Sheet 1 of 1 |
| Engineer: LJG | | 05/30/2014 | |

NCL30030GEVB

PFC INDUCTOR SPECIFICATION

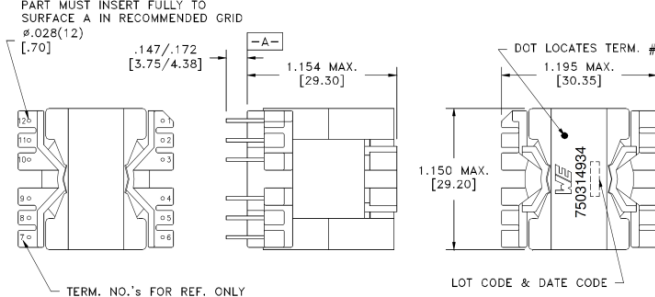
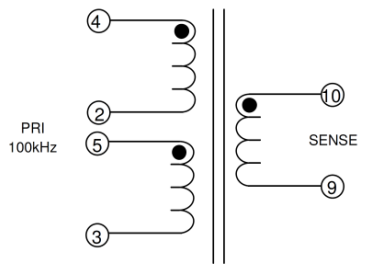
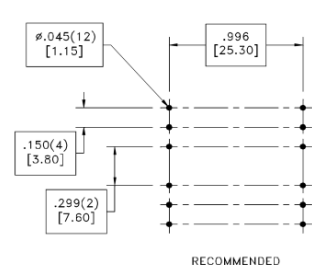
| | | | |
|--|---|--|---|
| CUSTOMER TERMINAL Sn96%, Ag4% | RoHS Yes | LEAD(Pb)-FREE Yes |  |
| <p style="font-size: small;">PART MUST INSERT FULLY TO SURFACE A IN RECOMMENDED GRID</p>  <p style="font-size: x-small;">TERM. NO.'s FOR REF. ONLY</p> <p style="font-size: x-small;">LOT CODE & DATE CODE</p> | | | |
|  | |  <p style="font-size: x-small; text-align: center;">RECOMMENDED P.C. PATTERN, COMPONENT SIDE</p> | |
| <p>ELECTRICAL SPECIFICATIONS @ 25°C unless otherwise noted:</p> <p>D.C. RESISTANCE (@20°C): 2-5 (tie 3+4), 0.183 Ohms ±10%. 9-10, 0.026 Ohms ±20%.</p> <p>DIELECTRIC RATING: 500VAC, 1 minute tested by applying 625VAC for 1 second between pins 2-10 (tie3+4).</p> <p>INDUCTANCE: 350µH ±10%, 10kHz, 100mVAC, 0mADC, 2-5(3+4), Ls.</p> <p>SATURATION CURRENT: 8.4A saturating current that causes 20% rolloff from initial inductance.</p> <p>LEAKAGE INDUCTANCE: 35µH max., 100kHz, 100mVAC, 2-5(tie 3+4, 9+10), Ls.</p> <p>TURNS RATIO: (5-3):(4-2), (2.33):(1.00), ±1%. (5-2):(10-9), (15):(1.00), (tie 3+4), ±1%.</p> | | | |
| <p>OPERATING TEMPERATURE RANGE: -40°C to 125°C including temp. rise.</p> <p>Wire insulation & RoHS status not affected by wire color. Wire insulation color may vary depending on availability.</p> | | | |
| Wurth Electronics Midcom Inc. Watertown, SD USA Toll Free: 800-643-2661 Fax: 605-886-4486 | Unless otherwise specified, tolerances are as follows: Angles: ±1° Fractions: ±1/64 Decimals: ±.005(.127mm) Footprint: ±.001(.03mm) | | more than you expect |
| | Drawing Title <h3 style="margin: 0;">Inductor</h3> | | Drawing Number Rev. <h2 style="margin: 0;">750314934</h2> 00 |
| This drawing is dual dimensioned. Dimensions is brackets are in millimeters | | Revisions: See Sheet 1 | Scale ---- Spec Sheet 1 of 1 |
| Engineer:LJG | | 07/17/2014 | |

NCL30030GEVB

ECA PICTURES

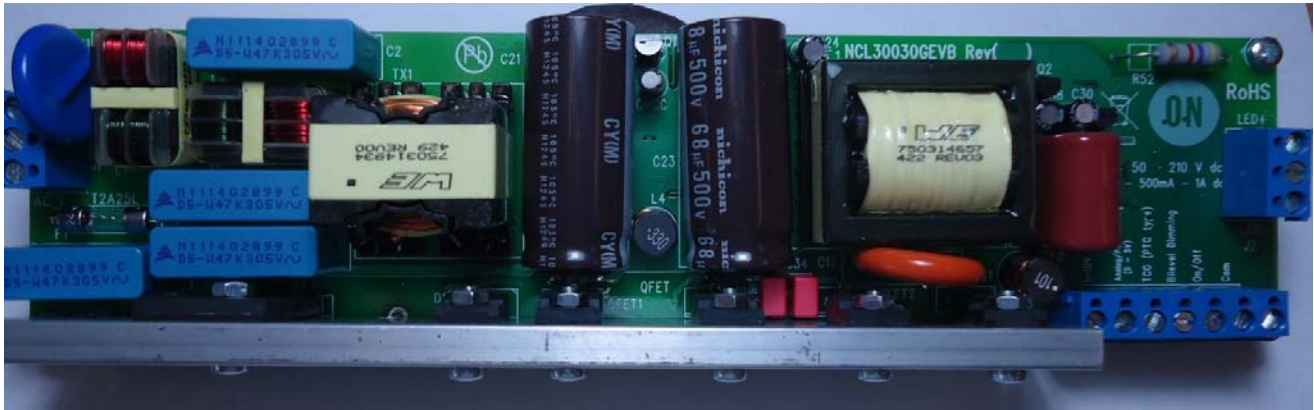

Figure 13. Top View

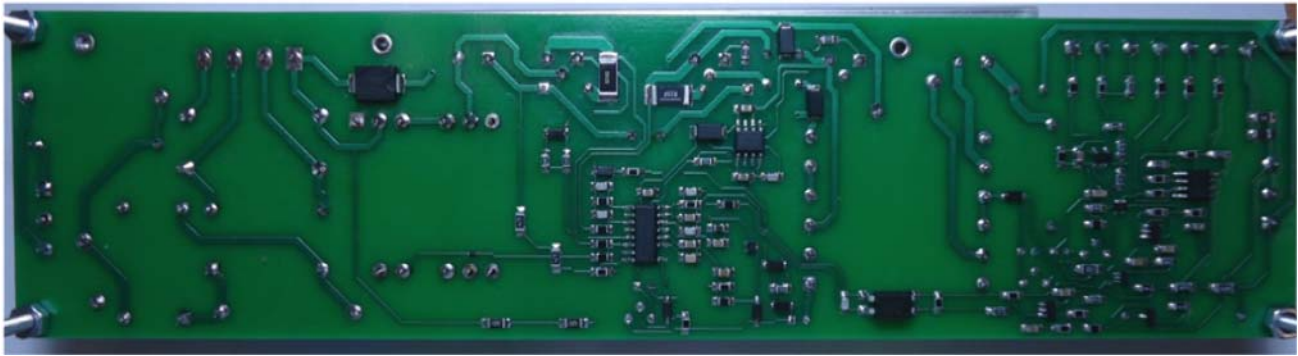

Figure 14. Bottom View

NCL30030GEVB

Material - 6063/61 Al
Break sharp edges

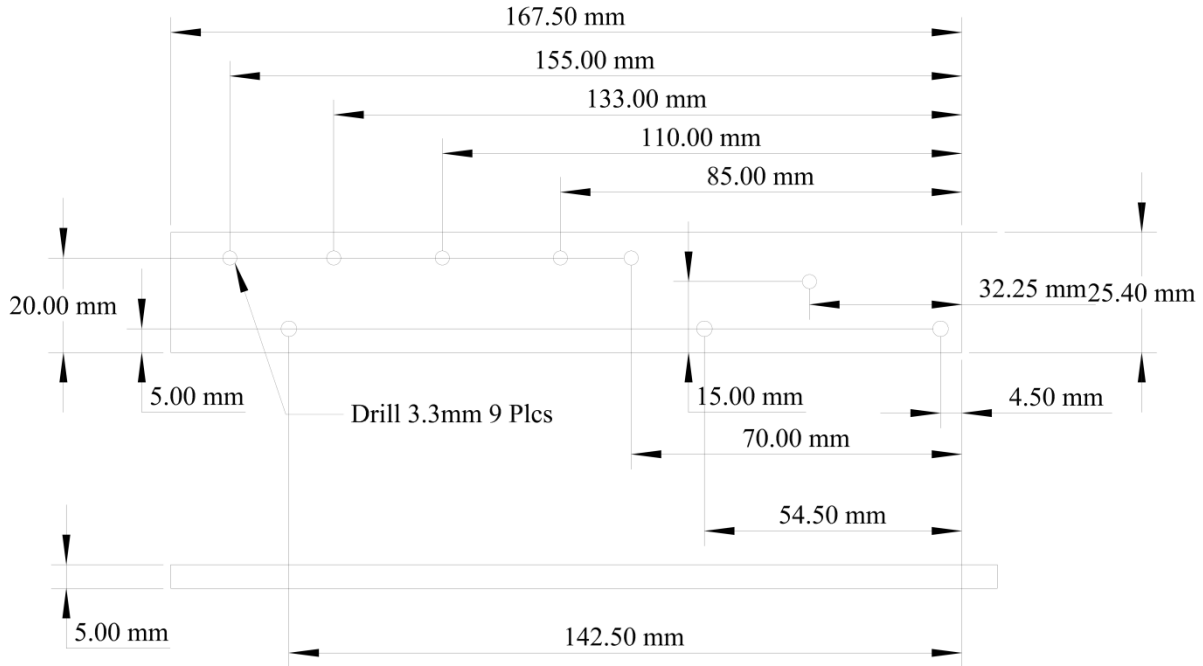

Figure 15. NCL30030 Heatspreader

TEST PROCEDURE

Equipment Needed

- AC Source – 90 to 305 V ac 50/60 Hz Minimum 500 W capability
- AC Wattmeter – 300 W Minimum, True RMS Input Voltage, Current, Power Factor, and THD 0.2% accuracy or better
- DC Voltmeter – 300 V dc minimum 0.1% accuracy or better
- DC Ammeter – 1 A dc minimum 0.1% accuracy or better
- LED Load – 50 V – 210 V @ 1 A

Test Connections

1. Connect the LED Load to J2 through the ammeter shown in Figure 16.

WARNING: Observe the correct polarity or the load may be damaged.

2. Connect the AC power card to J1 and connect the other end to the AC wattmeter shown in Figure 16.
3. Connect a Switch between J3-6 and J3-7. This switch will provide on/off control.
4. Short J3-4 to J3-7. This replaces the external TCO.
5. Connect a 100k Potentiometer to J3 as follows: high side to J3-1, wiper to J3-2, low side to J3-7.
6. Connect the DC voltmeter as shown in Figure 16.

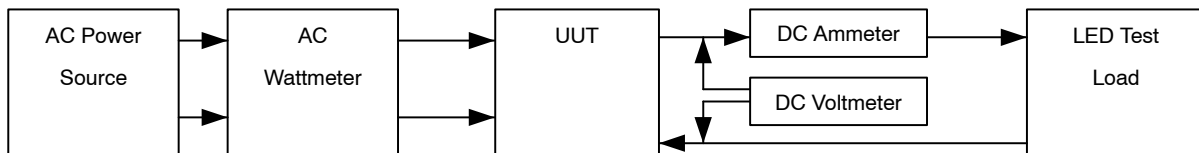

NOTE: Unless otherwise specified, all voltage measurements are taken at the terminals of the UUT.

Figure 16. Test Set Up

NCL30030GEVB

Functional Test Procedure

1. Set the potentiometer to about 50% of its rotation.

NOTE: The on-off switch should be in the open state until instructed otherwise.

2. Set the LED Load for 60 V output.

3. Set the input power to 120 V 60 Hz.

WARNING: Do not touch the ECA once it is energized because there are hazardous voltages present.

4. Close the On/off switch.

LINE AND LOAD REGULATION

Table 4. 120 V / MAX LOAD

Set the potentiometer fully CW (i.e. maximum output)

| | Output Current 710 mA ± 14 mA | Output Power | Power Factor | THD < 20% |
|-------|----------------------------------|--------------|--------------|-----------|
| 60 V | | | | |
| 120 V | | | | |
| 210 V | | | | |

Table 5. 120 V / MIN LOAD

Set the potentiometer fully CCW (i.e. minimum output)

| | Output Current 70 mA Max | Output Power | Power Factor | |
|-------|-----------------------------|--------------|--------------|--|
| 60 V | | | | |
| 120 V | | | | |
| 210 V | | | | |

Table 6. 277 V / MAX LOAD

Set the potentiometer fully CW (i.e. maximum output)

| | Output Current 710 mA ± 14 mA | Output Power | Power Factor | THD < 20% |
|-------|----------------------------------|--------------|--------------|-----------|
| 60 V | | | | |
| 120 V | | | | |
| 210 V | | | | |

Table 7. 277 V / MIN LOAD

Set the potentiometer fully CCW (i.e. minimum output)

| | Output Current 70 mA Max | Output Power | Power Factor | |
|-------|-----------------------------|--------------|--------------|--|
| 60 V | | | | |
| 120 V | | | | |
| 210 V | | | | |

$$\text{Efficiency} = \frac{V_{\text{out}} \times I_{\text{out}}}{P_{\text{in}}} \times 100\%$$

NCL30030GEVB

TEST DATA

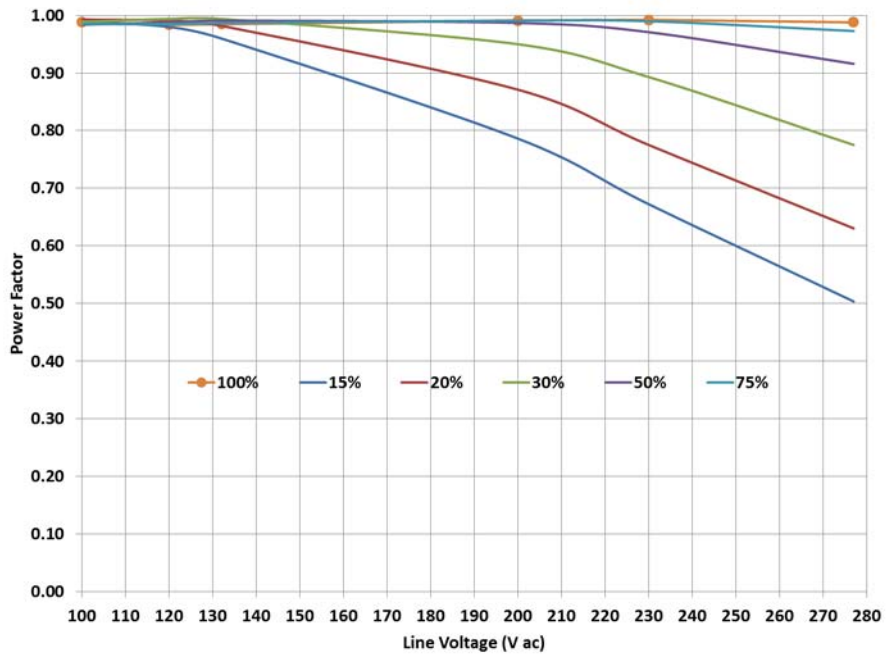

Figure 17. Power Factor over Line and Load

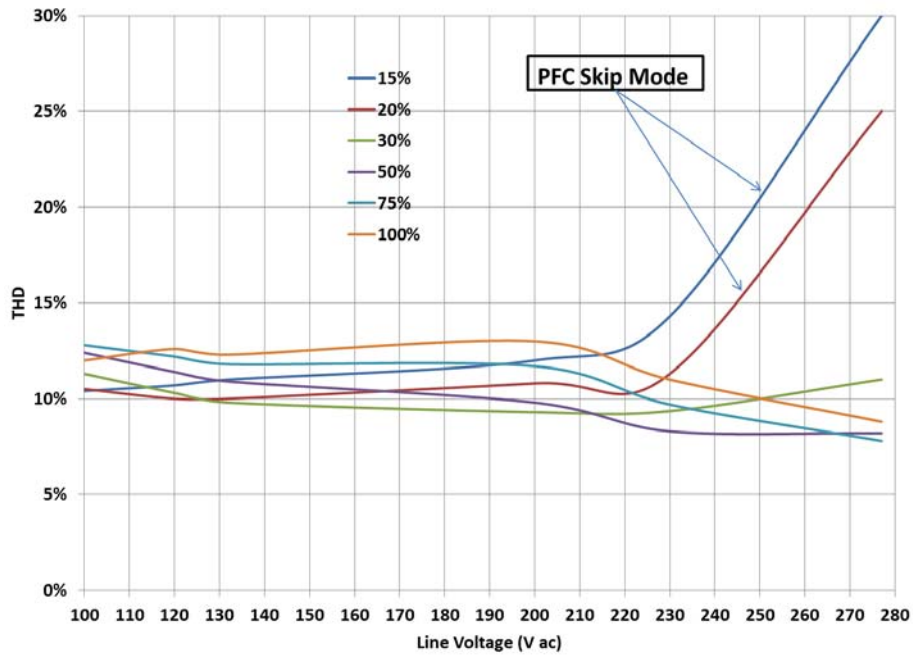

Figure 18. THD over Line and Load

NCL30030GEVB

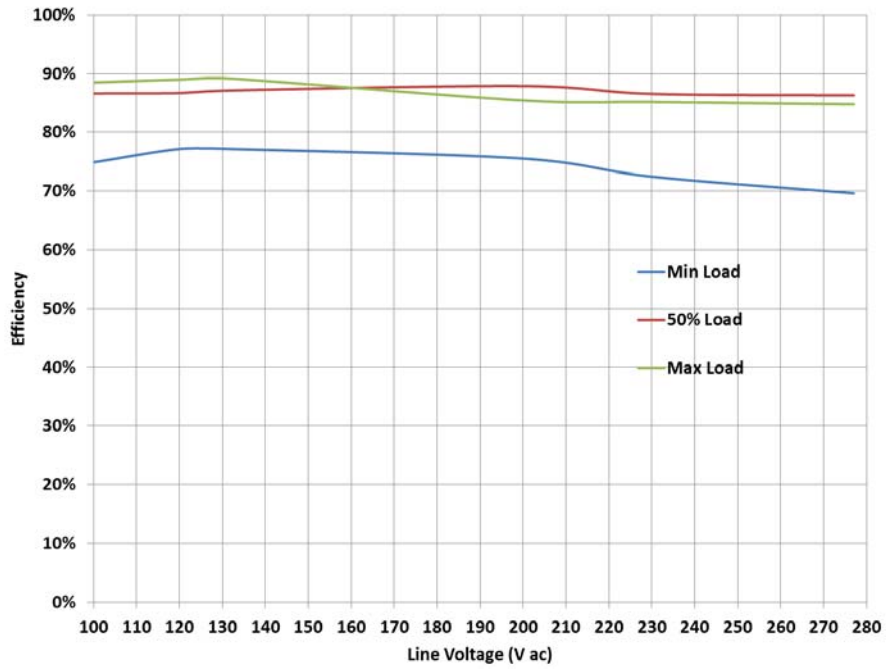

Figure 19. Efficiency over Line and Load @ 60 V dc Output

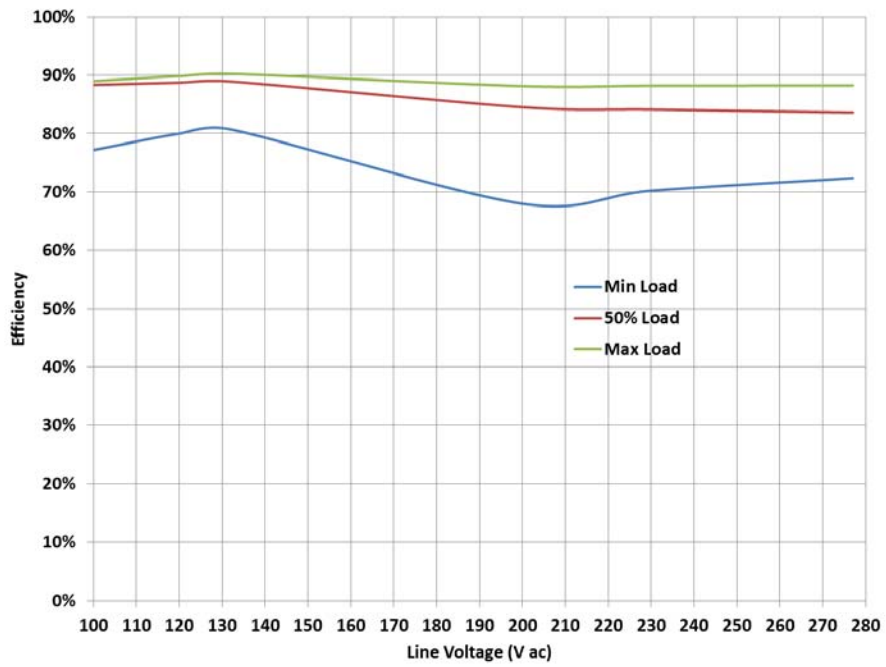

Figure 20. Efficiency over Line and Load @ 120 V dc Output

NCL30030GEVB

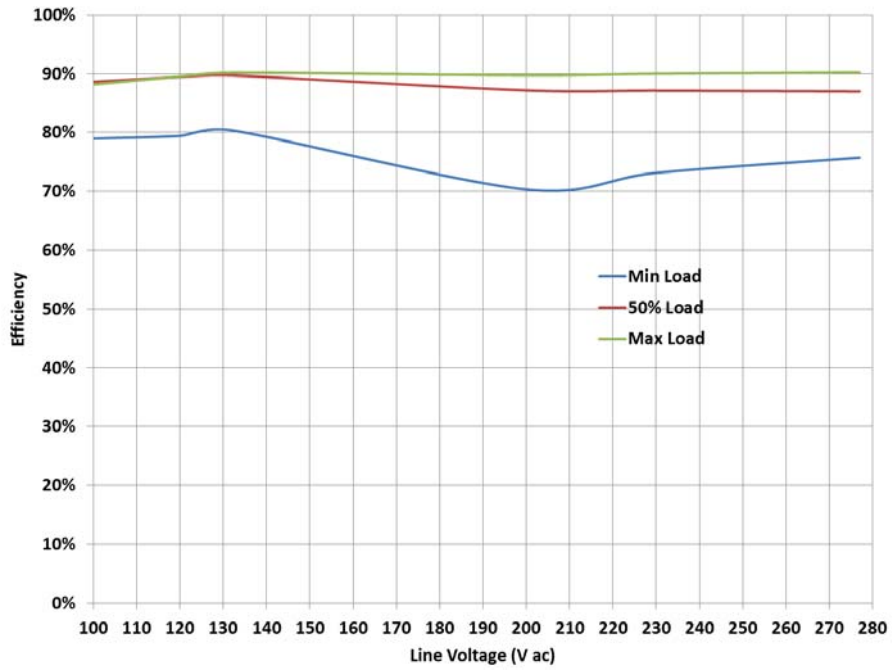

Figure 21. Efficiency over Line and Load @ 210 V dc Output

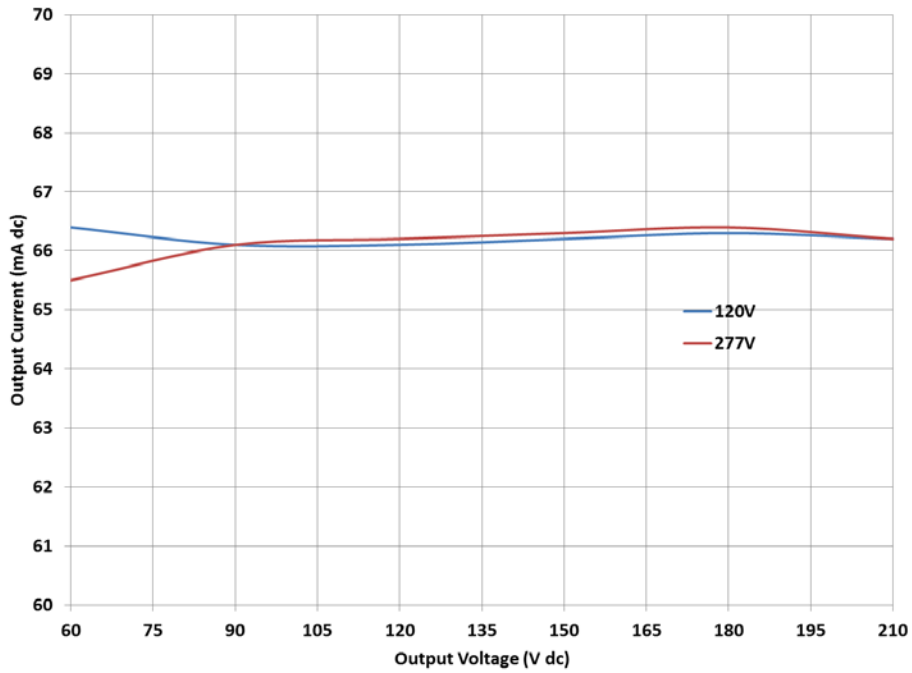

Figure 22. Minimum Load Regulation over Line

NCL30030GEVB

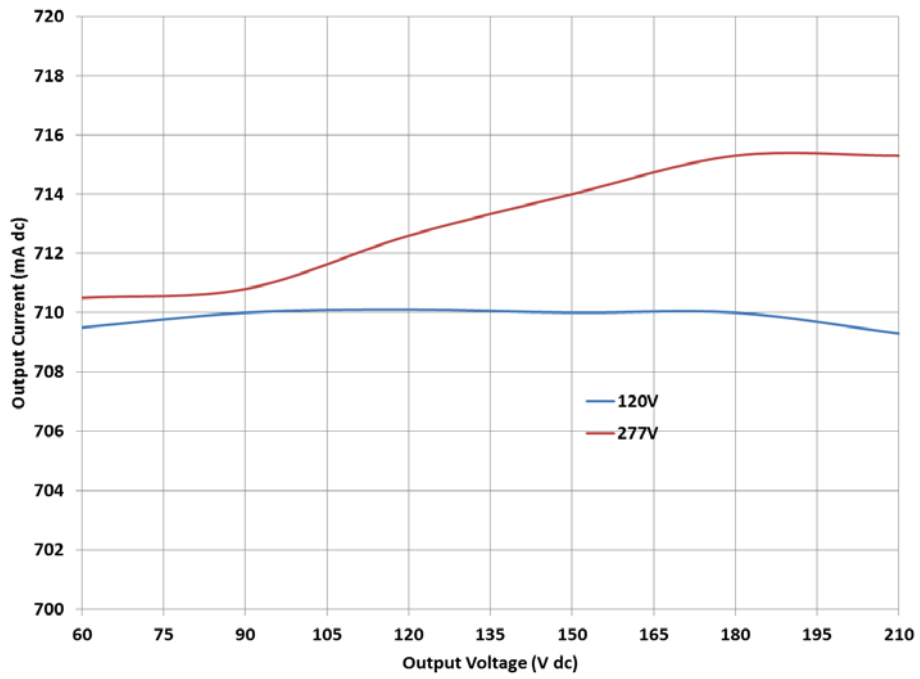

Figure 23. Maximum Load Regulation over Line

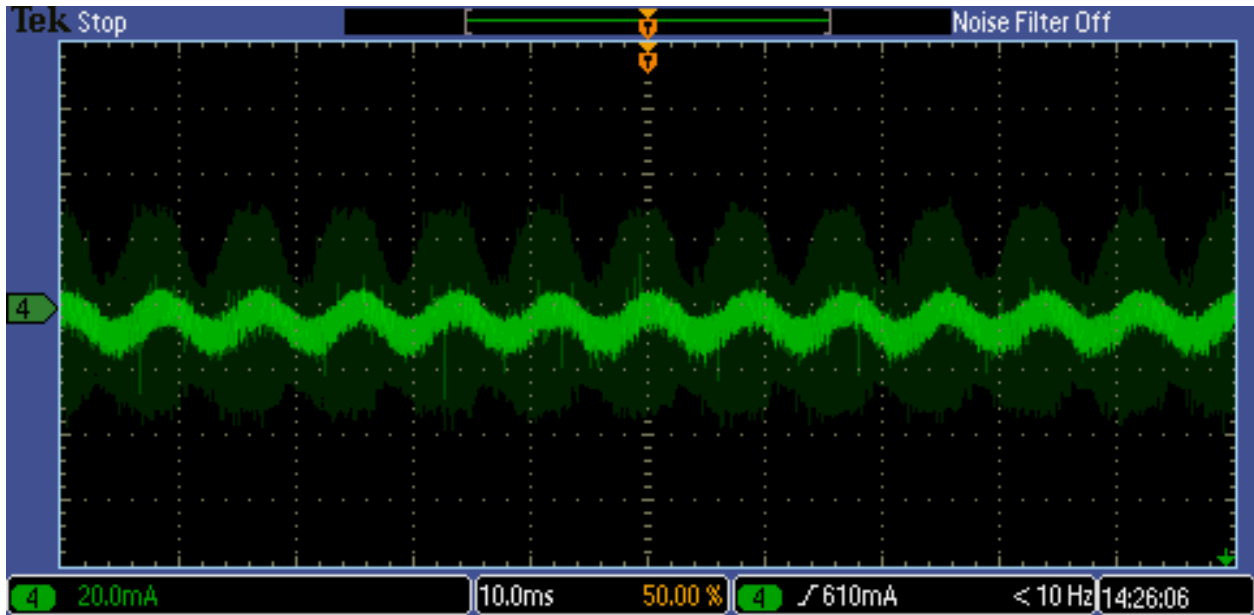

Figure 24. Ripple Current at 120 V ac Maximum Load

NCL30030GEVB

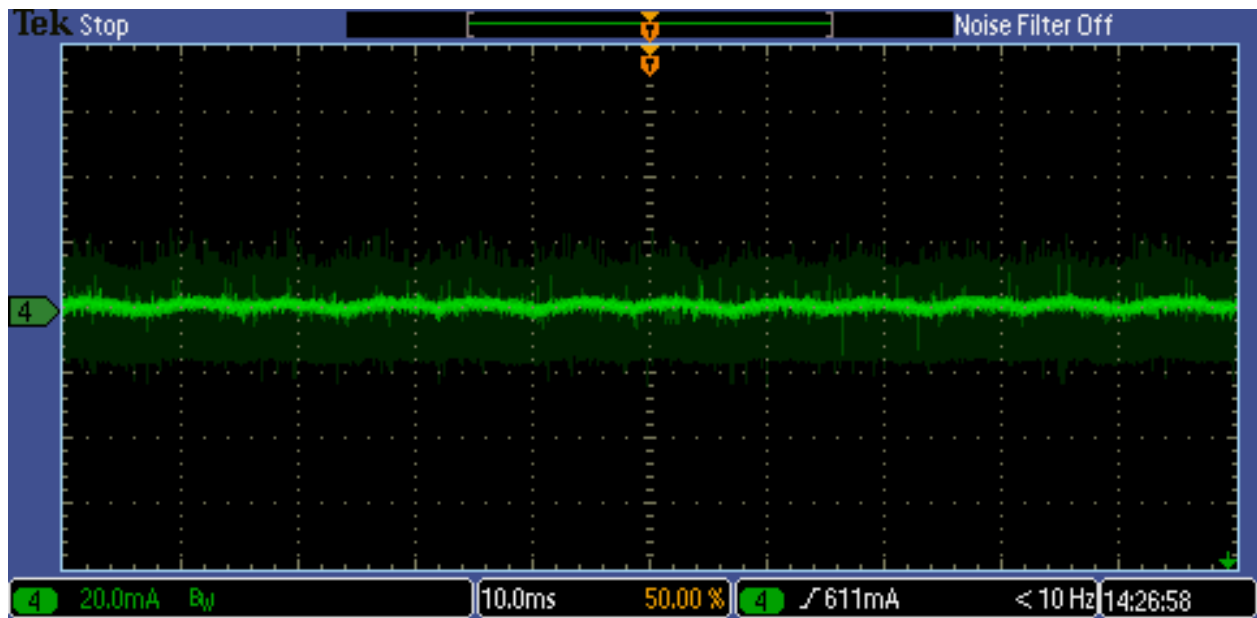

Figure 25. Ripple Current at 277 V ac Maximum Load

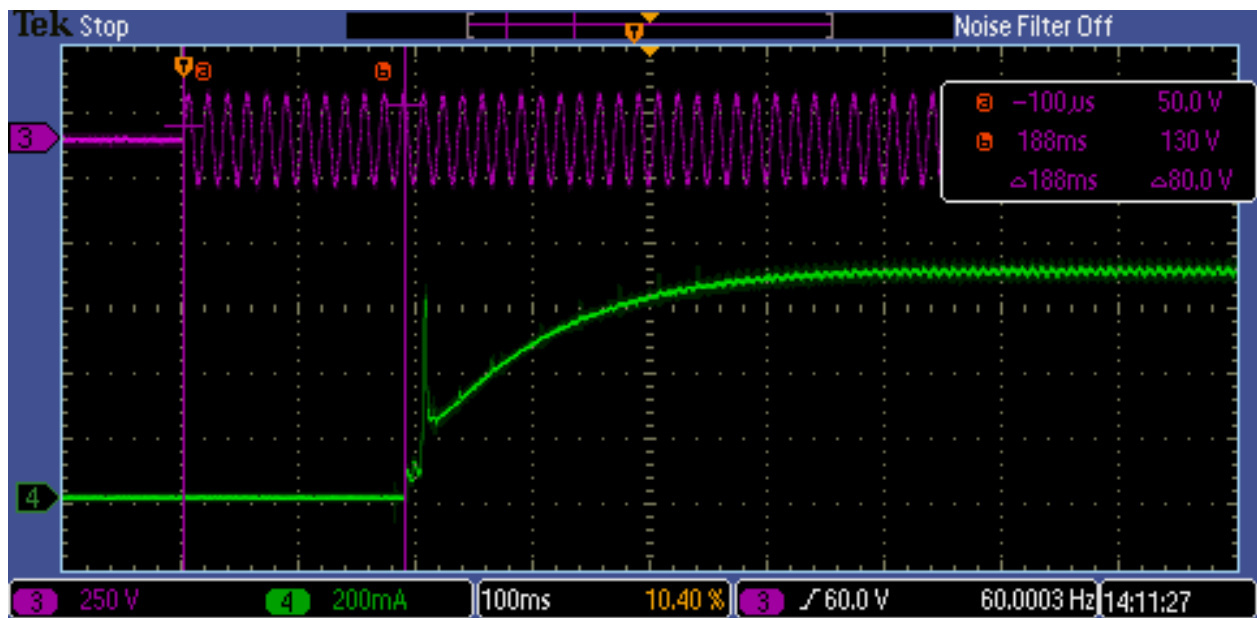

Figure 26. Start Up with AC Applied 120 V Maximum Load

NCL30030GEVB

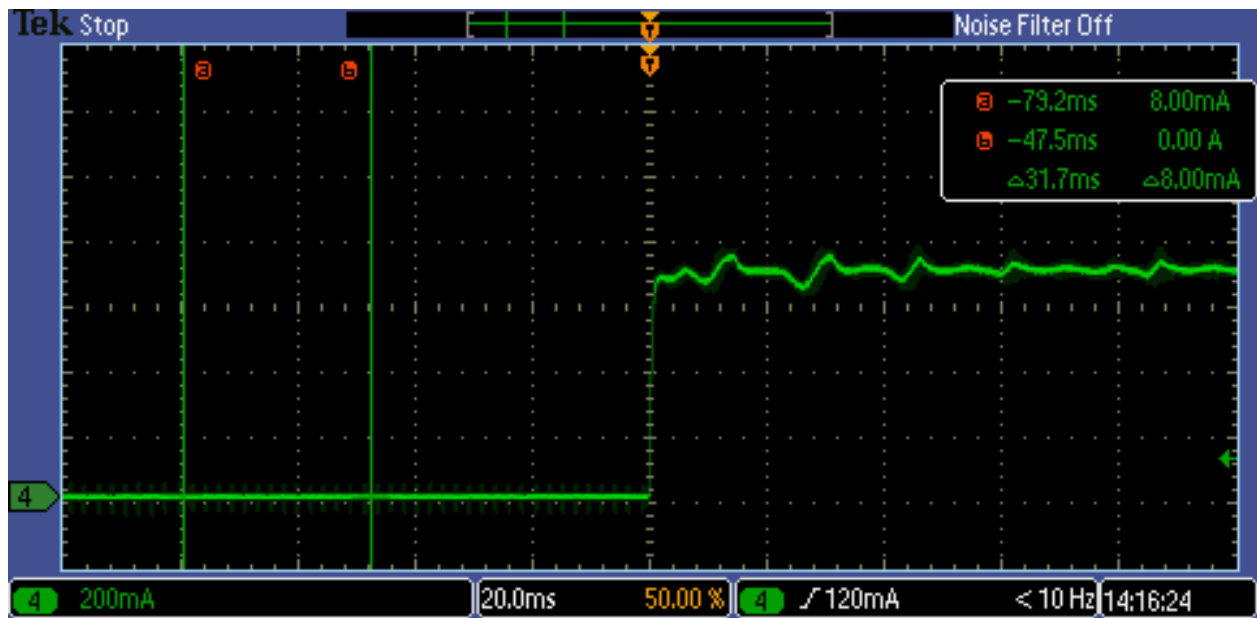

Figure 27. Start Up with On/Off 120 V Maximum Load

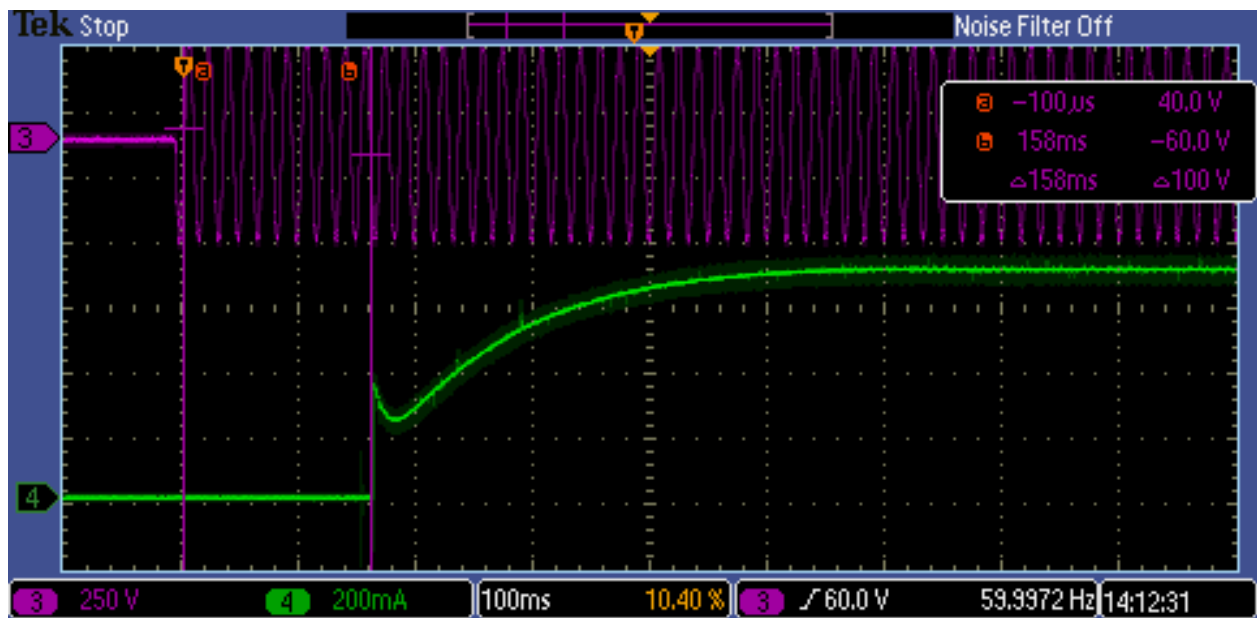

Figure 28. Start Up with AC Applied 277 V Maximum Load

NCL30030GEVB

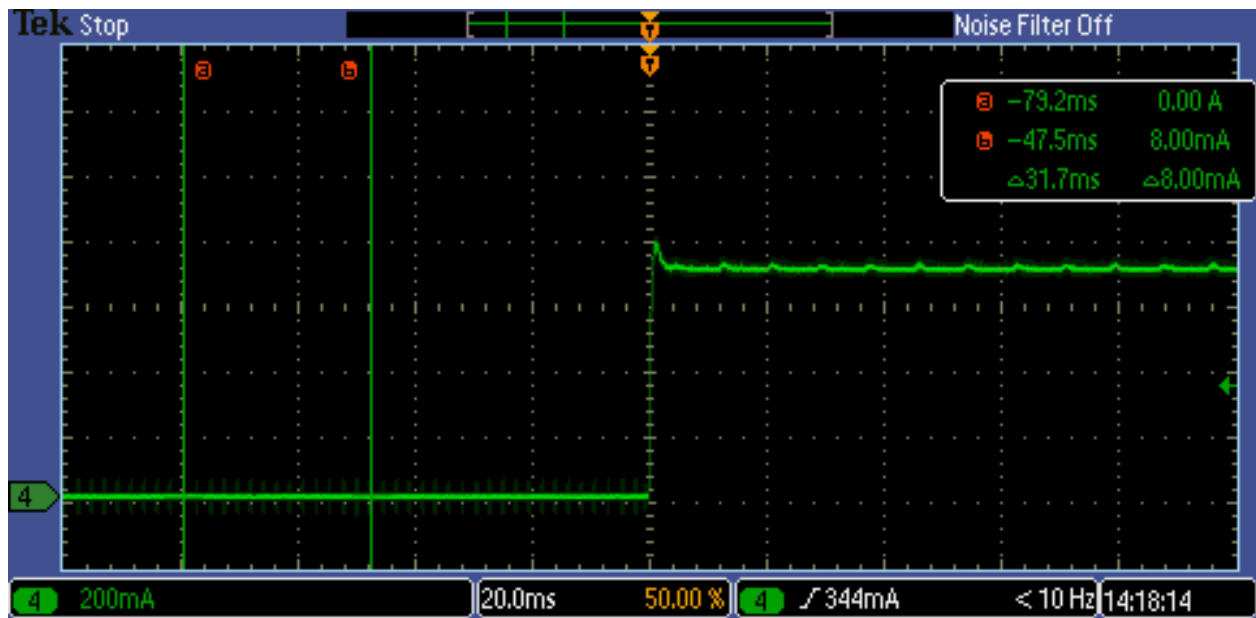

Figure 29. Start Up with AC Applied 277 V Maximum Load

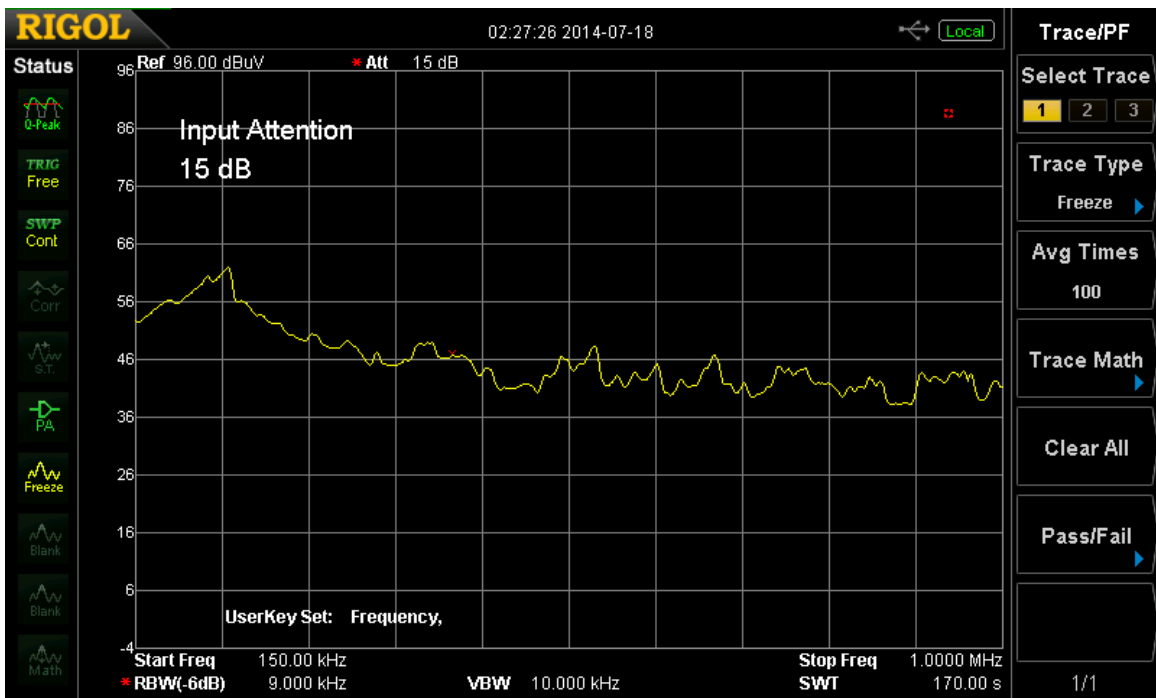

Figure 30. Conducted EMI Pre-compliance QP Data 150 kHz – 1 MHz

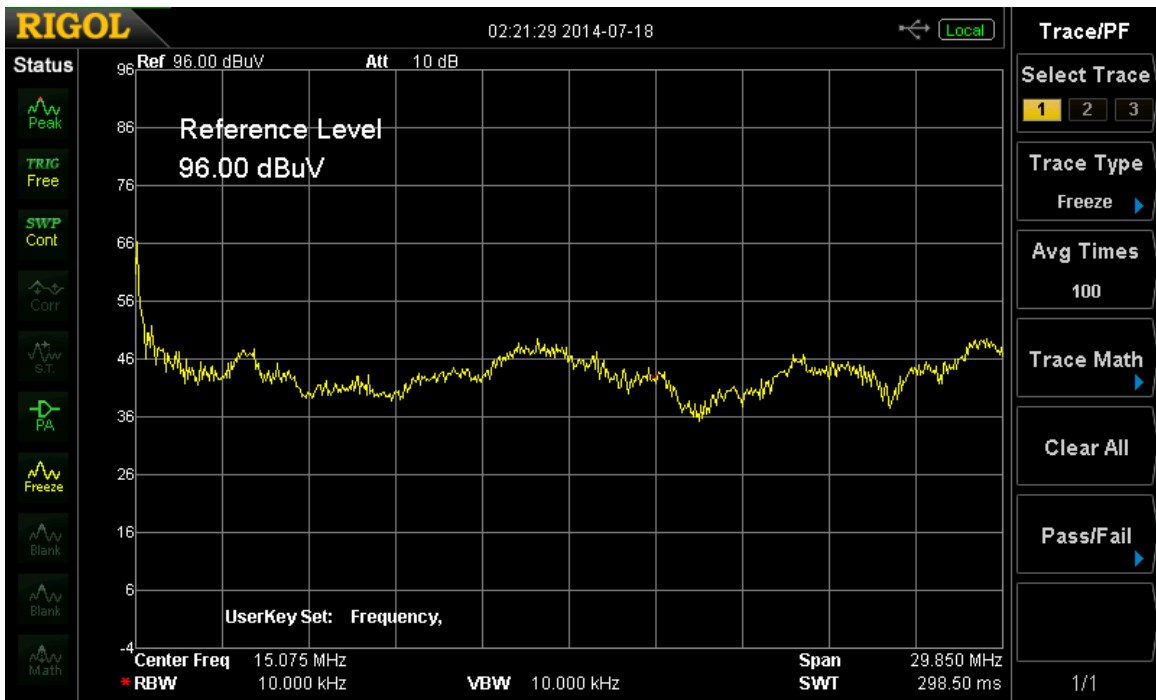



Figure 31. Conducted EMI Pre-compliance Peak Data 150 kHz – 30 MHz

NCL30030GEVB

| Product: NCL30030_04 | | Serial No. N/A | | 18-Jul-2014 3:27:03PM | | | | |
|--|----------|--|---|----------------------------|-----|----------|--------|----------|
| Description: 277Vac 50% Load | | Page: 1 of 1 | | | | | | |
| Voltech Pre-Compliance IEC61000-3-2 Windows Software | | | Test Date: 18th Jul 2014 15:22:56 PM | | | | | |
| Type of Test: IEC61000-3-2:2005 with Interharmonics to EN61000-4-7:2002 | | | - Worst Case Table | | | | | |
| Power Analyzer: Voltech,PM1000+,100008202290,Ver.4.25 | | | AC Source: Mains / AC Source | | | | | |
| Notes: | | Overall Result PASS | | Class: Class C,>25W | | | | |
| | | | | Class Multiplier: 1 | | | | |
| Supply Voltage outside permitted limits. Voltage Crest Factor outside permitted limits. | | | | | | | | |
| <L1 : Reading is below limit 1. <L2 : Reading is below limit 2. *x: Where Class D test has failed mA/W. <L2 (A) Reading is below 200% Class A Only. N/A : Harmonic current below 0.6% of rated current or 5mA, whichever is greater Or where the test is not applicable. | | | | | | | | |
| Harm | Limit1 | Limit2 | Avg Rdg | <L1 | <L2 | Max Rdg | <L2(A) | PassFail |
| 2 | 8.03mA | 12.045mA | 392.51uA | N/A | N/A | 439.74uA | N/A | Pass |
| 3 | 109.13mA | 163.70mA | 35.320mA | √ | √ | 35.413mA | N/A | Pass |
| 4 | N/A | N/A | N/A | N/A | N/A | N/A | N/A | N/A |
| 5 | 40.15mA | 60.225mA | 5.8642mA | √ | √ | 6.0307mA | N/A | Pass |
| 6 | N/A | N/A | N/A | N/A | N/A | N/A | N/A | N/A |
| 7 | 28.105mA | 42.157mA | 2.8301mA | N/A | N/A | 2.9105mA | N/A | Pass |
| 8 | N/A | N/A | N/A | N/A | N/A | N/A | N/A | N/A |
| 9 | 20.075mA | 30.112mA | 4.4183mA | N/A | N/A | 4.5284mA | N/A | Pass |
| 10 | N/A | N/A | N/A | N/A | N/A | N/A | N/A | N/A |
| 11 | 12.045mA | 18.067mA | 4.2518mA | N/A | N/A | 4.3112mA | N/A | Pass |
| 12 | N/A | N/A | N/A | N/A | N/A | N/A | N/A | N/A |
| 13 | 12.045mA | 18.067mA | 4.4052mA | N/A | N/A | 4.4703mA | N/A | Pass |
| 14 | N/A | N/A | N/A | N/A | N/A | N/A | N/A | N/A |
| 15 | 12.045mA | 18.067mA | 5.2873mA | √ | √ | 5.3438mA | N/A | Pass |
| 16 | N/A | N/A | N/A | N/A | N/A | N/A | N/A | N/A |
| 17 | 12.045mA | 18.067mA | 6.2557mA | √ | √ | 6.3697mA | N/A | Pass |
| 18 | N/A | N/A | N/A | N/A | N/A | N/A | N/A | N/A |
| 19 | 12.045mA | 18.067mA | 6.9573mA | √ | √ | 7.044mA | N/A | Pass |
| 20 | N/A | N/A | N/A | N/A | N/A | N/A | N/A | N/A |
| 21 | 12.045mA | 18.067mA | 6.8674mA | √ | √ | 6.9895mA | N/A | Pass |
| 22 | N/A | N/A | N/A | N/A | N/A | N/A | N/A | N/A |
| 23 | 12.045mA | 18.067mA | 5.1907mA | √ | √ | 5.2708mA | N/A | Pass |
| 24 | N/A | N/A | N/A | N/A | N/A | N/A | N/A | N/A |
| 25 | 12.045mA | 18.067mA | 3.9413mA | N/A | N/A | 4.0163mA | N/A | Pass |
| 26 | N/A | N/A | N/A | N/A | N/A | N/A | N/A | N/A |
| 27 | 12.045mA | 18.067mA | 1.9888mA | N/A | N/A | 2.0764mA | N/A | Pass |
| 28 | N/A | N/A | N/A | N/A | N/A | N/A | N/A | N/A |
| 29 | 12.045mA | 18.067mA | 1.5153mA | N/A | N/A | 1.5804mA | N/A | Pass |
| 30 | N/A | N/A | N/A | N/A | N/A | N/A | N/A | N/A |
| 31 | 12.045mA | 18.067mA | 918.62uA | N/A | N/A | 970.26uA | N/A | Pass |
| 32 | N/A | N/A | N/A | N/A | N/A | N/A | N/A | N/A |
| 33 | 12.045mA | 18.067mA | 852.27uA | N/A | N/A | 921.39uA | N/A | Pass |
| 34 | N/A | N/A | N/A | N/A | N/A | N/A | N/A | N/A |
| 35 | 12.045mA | 18.067mA | 875.08uA | N/A | N/A | 943.05uA | N/A | Pass |
| 36 | N/A | N/A | N/A | N/A | N/A | N/A | N/A | N/A |
| 37 | 12.045mA | 18.067mA | 741.90uA | N/A | N/A | 800.19uA | N/A | Pass |
| 38 | N/A | N/A | N/A | N/A | N/A | N/A | N/A | N/A |
| 39 | 12.045mA | 18.067mA | 842.32uA | N/A | N/A | 1.0056mA | N/A | Pass |
| 40 | N/A | N/A | N/A | N/A | N/A | N/A | N/A | N/A |

Figure 32. IEC61000-3-2 Report 277 V 50% Load 60 Hz

NCL30030GEVB

ON Semiconductor and the  are registered trademarks of Semiconductor Components Industries, LLC (SCILLC) or its subsidiaries in the United States and/or other countries. SCILLC owns the rights to a number of patents, trademarks, copyrights, trade secrets, and other intellectual property. A listing of SCILLC's product/patent coverage may be accessed at www.onsemi.com/site/pdf/Patent-Marking.pdf. SCILLC reserves the right to make changes without further notice to any products herein. SCILLC makes no warranty, representation or guarantee regarding the suitability of its products for any particular purpose, nor does SCILLC assume any liability arising out of the application or use of any product or circuit, and specifically disclaims any and all liability, including without limitation special, consequential or incidental damages. "Typical" parameters which may be provided in SCILLC data sheets and/or specifications can and do vary in different applications and actual performance may vary over time. All operating parameters, including "Typicals" must be validated for each customer application by customer's technical experts. SCILLC does not convey any license under its patent rights nor the rights of others. SCILLC products are not designed, intended, or authorized for use as components in systems intended for surgical implant into the body, or other applications intended to support or sustain life, or for any other application in which the failure of the SCILLC product could create a situation where personal injury or death may occur. Should Buyer purchase or use SCILLC products for any such unintended or unauthorized application, Buyer shall indemnify and hold SCILLC and its officers, employees, subsidiaries, affiliates, and distributors harmless against all claims, costs, damages, and expenses, and reasonable attorney fees arising out of, directly or indirectly, any claim of personal injury or death associated with such unintended or unauthorized use, even if such claim alleges that SCILLC was negligent regarding the design or manufacture of the part. SCILLC is an Equal Opportunity/Affirmative Action Employer. This literature is subject to all applicable copyright laws and is not for resale in any manner.

PUBLICATION ORDERING INFORMATION

LITERATURE FULFILLMENT:

Literature Distribution Center for ON Semiconductor
P.O. Box 5163, Denver, Colorado 80217 USA
Phone: 303-675-2175 or 800-344-3860 Toll Free USA/Canada
Fax: 303-675-2176 or 800-344-3867 Toll Free USA/Canada
Email: orderlit@onsemi.com

N. American Technical Support: 800-282-9855 Toll Free
USA/Canada
Europe, Middle East and Africa Technical Support:
Phone: 421 33 790 2910
Japan Customer Focus Center
Phone: 81-3-5817-1050

ON Semiconductor Website: www.onsemi.com
Order Literature: <http://www.onsemi.com/orderlit>
For additional information, please contact your local
Sales Representative

Данный компонент на территории Российской Федерации

Вы можете приобрести в компании MosChip.

Для оперативного оформления запроса Вам необходимо перейти по данной ссылке:

<http://moschip.ru/get-element>

Вы можете разместить у нас заказ для любого Вашего проекта, будь то серийное производство или разработка единичного прибора.

В нашем ассортименте представлены ведущие мировые производители активных и пассивных электронных компонентов.

Нашей специализацией является поставка электронной компонентной базы двойного назначения, продукции таких производителей как XILINX, Intel (ex.ALTERA), Vicor, Microchip, Texas Instruments, Analog Devices, Mini-Circuits, Amphenol, Glenair.

Сотрудничество с глобальными дистрибьюторами электронных компонентов, предоставляет возможность заказывать и получать с международных складов практически любой перечень компонентов в оптимальные для Вас сроки.

На всех этапах разработки и производства наши партнеры могут получить квалифицированную поддержку опытных инженеров.

Система менеджмента качества компании отвечает требованиям в соответствии с ГОСТ Р ИСО 9001, ГОСТ РВ 0015-002 и ЭС РД 009

Офис по работе с юридическими лицами:

105318, г.Москва, ул.Щербаковская д.3, офис 1107, 1118, ДЦ «Щербаковский»

Телефон: +7 495 668-12-70 (многоканальный)

Факс: +7 495 668-12-70 (доб.304)

E-mail: info@moschip.ru

Skype отдела продаж:

moschip.ru

moschip.ru_4

moschip.ru_6

moschip.ru_9