

FEATURES

- Input-to-output response: <100 ns**
- High input common-mode voltage range**
 - Operating: 5 V to 65 V**
 - Survival: 0 V to 68 V**
- Current output**
- Hysteresis: 10 mV**
- Integrated 2.4 V regulator**
- Wide operating temperature range: -40°C to +125°C**
- 8-lead MSOP package**
- Qualified for automotive applications**

APPLICATIONS

- Overcurrent protection**
 - Motor controls**
 - Transmission controls**
 - Diesel injection controls**
 - DC-to-DC converters**
 - Power supplies**
 - Batteries**

GENERAL DESCRIPTION

The AD8214 is a fast response, high common-mode voltage, current shunt comparator. The device operates on the high side rail of any DC current sensing application, provided the voltage is between 5 V and 65 V. Internally, the AD8214 features a fast comparator that is optimized for high side operation. An internal Zener regulator powers the circuit with respect to the high side DC rail. In addition, user access to this 2.4V regulator, allows for setting a comparator threshold voltage via external resistors. The AD8214 will compare the voltage across the shunt resistor to this user-selected threshold, and the AD8214 output will change states from low to high, indicating the current across the shunt has crossed the threshold level.



Figure 1.

The input to output response time of the AD8214 is typically less than 100 ns. This makes the device optimal for overcurrent protection in applications such as motor and solenoid control. Built-in comparator hysteresis means that once the current across the shunt falls back to a normal limit, the AD8214 output will change states to its original level.

The AD8214 is available in an 8-lead MSOP package. The operating temperature range is -40°C to +125°C, and the device is fully qualified for automotive applications.

Rev. A

Information furnished by Analog Devices is believed to be accurate and reliable. However, no responsibility is assumed by Analog Devices for its use, nor for any infringements of patents or other rights of third parties that may result from its use. Specifications subject to change without notice. No license is granted by implication or otherwise under any patent or patent rights of Analog Devices. Trademarks and registered trademarks are the property of their respective owners.

TABLE OF CONTENTS

Features	1	Comparator Offset and Hysteresis.....	11
Applications.....	1	Setting the Input Threshold Voltage.....	11
Functional Block Diagram	1	Input-Referred Dynamic Error	11
General Description	1	Applications.....	12
Revision History	2	Typical Setup and Calculations	12
Specifications.....	3	High Side Overcurrent Detection	13
Absolute Maximum Ratings.....	4	Outline Dimensions	14
ESD Caution.....	4	Ordering Guide	14
Pin Configuration and Function Descriptions.....	5	Automotive Products.....	14
Typical Performance Characteristics	6		
Theory of Operation	10		

REVISION HISTORY

6/12—Rev. 0 to Rev. A

Changes to Product Title	1
Changes to Features Section, and General Description Section.....	1
Changes to Table 1.....	3
Changes to Table 2.....	4
Changes to Ordering Guide; Added Automotive Products Section.....	14
Updated Outline Dimensions	14

10/06—Revision 0: Initial Version

SPECIFICATIONS

$V_S = 13.5\text{ V}$, unless otherwise noted.

Table 1.

Parameter	Conditions/Comments	Min	Typ	Max	Unit
VOLTAGE OFFSET					
Offset Voltage (RTI)	$T_A = 25^\circ\text{C}$, voltage at $-IN$ decreasing			± 3	mV
Over Temperature (RTI)				± 8	mV
Offset Drift				± 10	$\mu\text{V}/^\circ\text{C}$
HYSTERESIS	$T_A = 25^\circ\text{C}$, voltage at $-IN$ increasing	5		12	mV
INPUT					
Input Impedance	$V_S = 5\text{ V to } 65\text{ V}$		2		M Ω
Differential				5	M Ω
Common Mode					
Voltage Range					
Differential	Maximum voltage between $+IN$ and $-IN$			500	mV
Common Mode		$V_S - 0.9$		$V_S + 0.2$	V
Input Bias Current	$+IN$ or $-IN$		12	± 30	nA
OUTPUT					
Output Current	$R_{OUT} = 3.3\text{ k}\Omega$, output high	0.8	1	1.2	mA
	$R_{OUT} = 3.3\text{ k}\Omega$, output low			± 5	μA
Rise Time	20% to 80%, $R_{OUT} = 3.3\text{ k}\Omega$, $V_{OD} = 5\text{ mV}$, 50 mV step		90		ns
	20% to 80%, $R_{OUT} = 3.3\text{ k}\Omega$, $V_{OD} > 20\text{ mV}$, 50 mV step		75		ns
Fall Time	20% to 80%, $R_{OUT} = 3.3\text{ k}\Omega$, $V_{OD} = 5\text{ mV}$, 50 mV step		110		ns
	20% to 80%, $R_{OUT} = 3.3\text{ k}\Omega$, $V_{OD} > 10\text{ mV}$, 50 mV step		100		ns
REGULATOR					
Nominal Value	$T_A = 25^\circ\text{C}$, voltage from V_{REG} to V_S		2.43		V
	$T_A = -40^\circ\text{C to } +125^\circ\text{C}$		± 5		%
DYNAMIC RESPONSE					
Propagation Delay ¹	50 mV to 250 mV step				
	$5\text{ mV} \leq V_{OD} \leq 15\text{ mV}$, output low to high		90		ns
	$15\text{ mV} \leq V_{OD} \leq 30\text{ mV}$, output low to high		80		ns
	$V_{OD} \geq 30\text{ mV}$, output low to high		75		ns
INPUT-REFERRED DYNAMIC ERROR²			15		mV
POWER SUPPLY					
Operating Range					
Maximum Voltage	GND to V_S			65	V
Minimum Voltage	GND to V_S	5			V
Output Voltage Range ³	With respect to V_{REG}	2		62.5	V
Supply Current	Output low		240		μA
	Output high		1.2		mA
TEMPERATURE RANGE FOR SPECIFIED PERFORMANCE		-40		+125	$^\circ\text{C}$

¹ V_{OD} represents the overdrive voltage, or the amount of voltage by which the threshold point has been exceeded.

² See the Input-Referred Dynamic Error section.

³ The voltage at OUT must not be allowed to exceed the V_{REG} voltage, which is always 2.4 V less than the supply. For example, when the supply voltage is 5 V and the output current is 1 mA, the load resistor must not be more than $(5\text{ V} - 2.4\text{ V}) / (1\text{ mA} \times (1 + 20\%))$, or 2.17 k Ω , to ensure the signal does not exceed 2.6 V. As the supply increases, the output signal also can be increased, by the same amount.

ABSOLUTE MAXIMUM RATINGS

$T_A = -40^{\circ}\text{C}$ to $+125^{\circ}\text{C}$

Table 2.

Parameter	Rating
Supply Voltage	65 V
Continuous Input Voltage	68 V
Differential Input Voltage	500 mV
Reverse Supply Voltage	0.3 V
Operating Temperature Range	-40°C to $+125^{\circ}\text{C}$
Storage Temperature Range	-65°C to $+150^{\circ}\text{C}$
Output Short-Circuit Duration	Indefinite

Stresses above those listed under Absolute Maximum Ratings may cause permanent damage to the device. This is a stress rating only; functional operation of the device at these or any other conditions above those indicated in the operational section of this specification is not implied. Exposure to absolute maximum rating conditions for extended periods may affect device reliability.

ESD CAUTION



ESD (electrostatic discharge) sensitive device. Charged devices and circuit boards can discharge without detection. Although this product features patented or proprietary protection circuitry, damage may occur on devices subjected to high energy ESD. Therefore, proper ESD precautions should be taken to avoid performance degradation or loss of functionality.

PIN CONFIGURATION AND FUNCTION DESCRIPTIONS

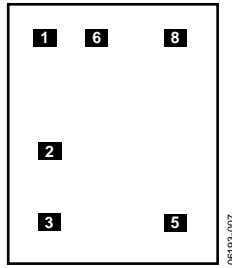

Figure 2. Metallization Diagram



Figure 3. Pin Configuration

Table 3. Pin Function Descriptions

Pin No.	Mnemonic	X	Y	Description
1	V_S	-196	+447	Supply Voltage.
2	+IN	-198	-58	Noninverting Input.
3	V_{REG}	-196	-346	Regulator Voltage.
4	NC			No Connect.
5	OUT	+196	-348	Output.
6	GND	+196	+447	Ground.
7	NC			No Connect.
8	-IN	-31	+449	Inverting Input.

TYPICAL PERFORMANCE CHARACTERISTICS



Figure 4. Input Bias Current vs. Input Common-Mode Voltage (With Respect to V_S)

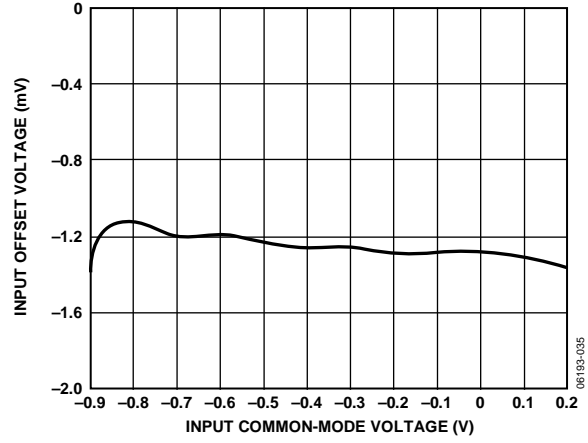

Figure 7. Input Offset Voltage vs. Input Common-Mode Voltage (With Respect to V_S)

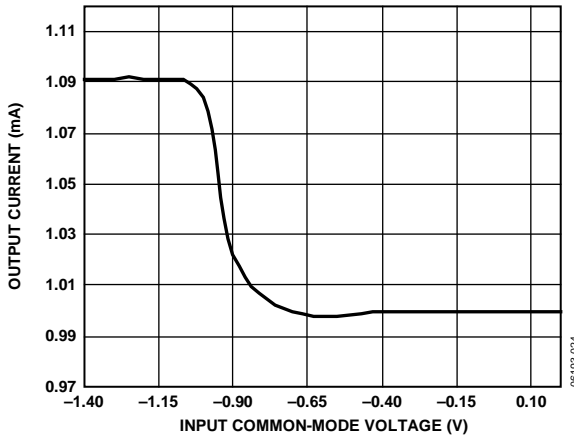

Figure 5. Output Current (Output High) vs. Input Common-Mode Voltage (With Respect to V_S)

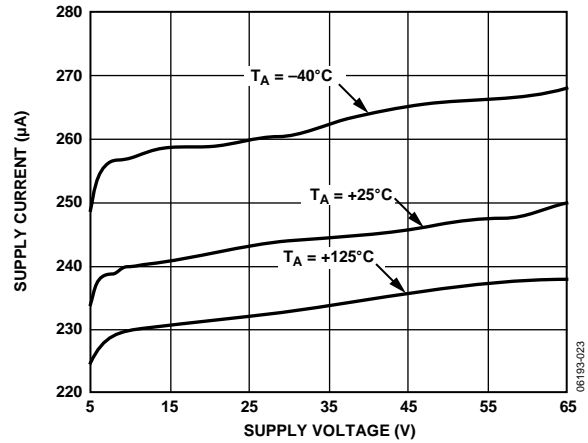

Figure 8. Supply Current vs. Supply Voltage (Output Low)

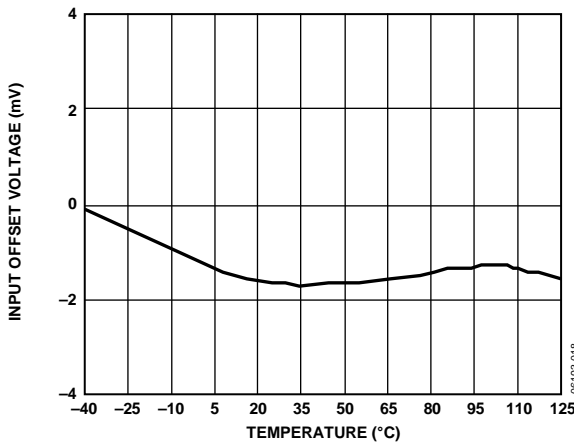

Figure 6. Input Offset Voltage vs. Temperature

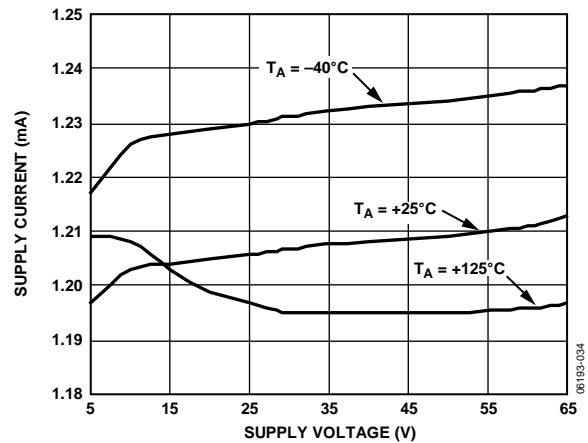

Figure 9. Supply Current vs. Supply Voltage (Output High)



Figure 10. Regulator Voltage vs. Supply Voltage (Between V_{REG} and V_S)



Figure 13. Output Current vs. Supply Voltage (Output High)



Figure 11. Regulator Voltage vs. Regulator Load Resistance (Series Resistance Between V_{REG} and V_S)



Figure 14. Hysteresis Voltage vs. Temperature ($-IN$ Increasing)

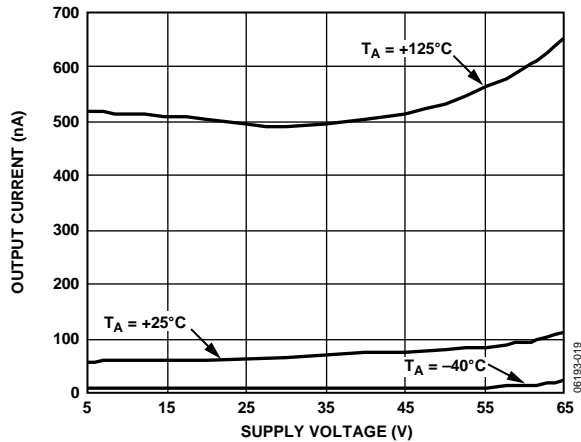

Figure 12. Output Current vs. Supply Voltage (Output Low)

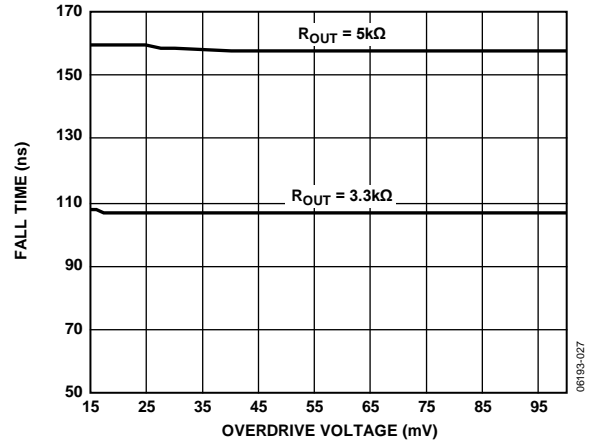

Figure 15. Fall Time vs. Overdrive Voltage ($-IN > +IN$ by Specified V_{OD})



Figure 16. Rise Time vs. Overdrive Voltage (+IN > -IN by Specified V_{OD})



Figure 19. Typical Propagation Delay (R_{OUT} = 5 kΩ)



Figure 17. Typical Propagation Delay (R_{OUT} = 5 kΩ)



Figure 20. Typical Propagation Delay (R_{OUT} = 5 kΩ)



Figure 18. Typical Propagation Delay (R_{OUT} = 5 kΩ)



Figure 21. Propagation Delay vs. Overdrive Voltage (-IN > +IN by Specified V_{OD}, Output High to Low)

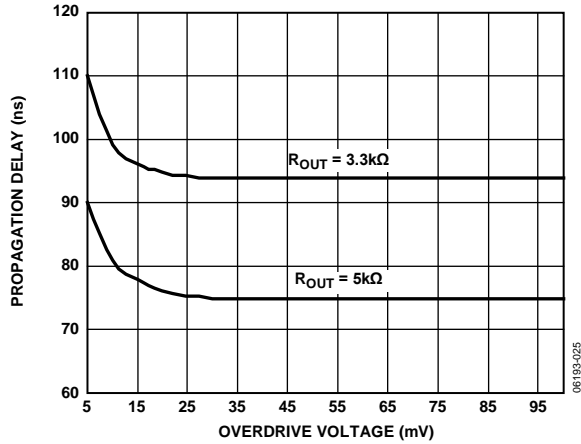

Figure 22. Propagation Delay vs. Overdrive Voltage, (+IN > -IN by Specified V_{OD} , Output Low to High)

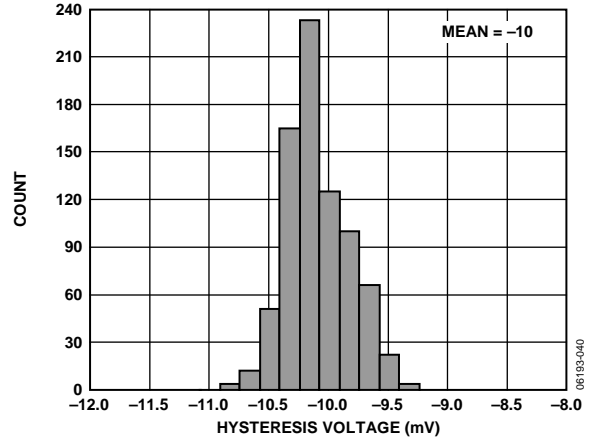

Figure 25. Hysteresis Voltage Distribution



Figure 23. Hysteresis Voltage vs. Input Common-Mode Voltage (With Respect to V_S)

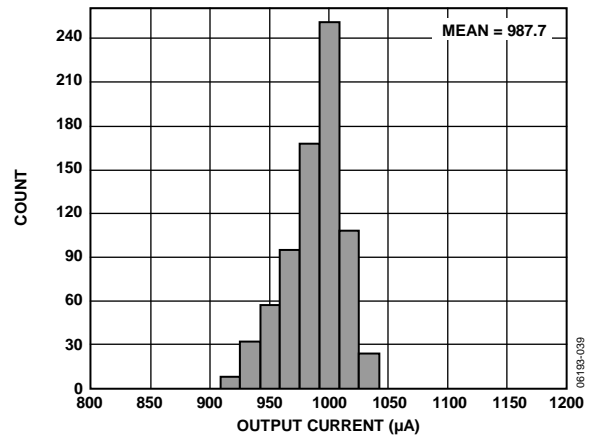

Figure 26. Output Current Distribution



Figure 24. Input Offset Voltage Distribution

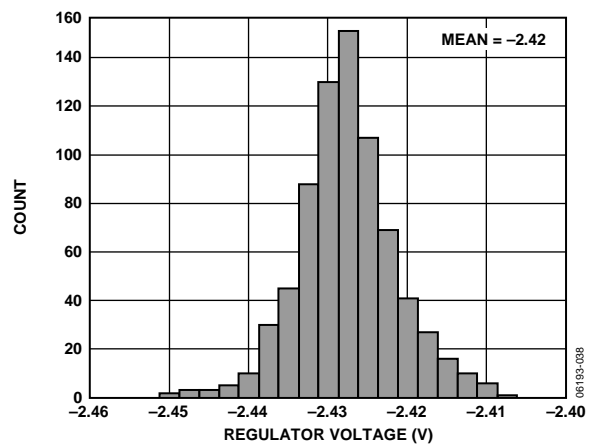

Figure 27. Regulator Voltage Distribution (With Respect to V_S)

THEORY OF OPERATION

The AD8214 is a high voltage comparator offering an input-to-output response time of less than 100 ns. This device is ideal for detecting overcurrent conditions on the high side of the control loop. The AD8214 is designed specifically to facilitate and allow for fast shutdown of the control loop, preventing damage due to excessive currents to the FET, load, or shunt resistor.

The AD8214 operates with a supply of 5 V to 65 V. It combines a fast comparator, optimized for high side operation, with a 2.4 V series voltage regulator. The regulator provides a stable voltage that is negative with respect to the positive supply rail, and it is intended to provide power to the internal electronics, set a comparison threshold below the supply rail, and power small application circuits used with the comparator.

The differential input of the comparator may be operated at, or slightly above or below, the positive supply rail. Typically, one of the comparator inputs is driven negative with respect to the positive supply by a small series resistor carrying the main supply current to the load. The other input of the comparator

connects to a voltage divider across the regulator, so the comparator trips as the voltage across the series resistor crosses the user-selected threshold.

The AD8214 features a current output. The current is low (100 nA typical), until the user selected threshold is crossed. After this point the output switches to high (1 mA typical). The current output driver complies with load voltage from 0 V to $(V_S - 2.4 \text{ V})$. The current easily drives a ground referenced resistor to develop logic levels determined by the value of the load resistor.

The comparator input is balanced to switch as the inverting input ($-IN$) is driven negative with respect to the noninverting input ($+IN$). As the comparator output switches from 0 mA to 1 mA, a small hysteresis (10 mV) is activated to minimize the effects of noise in the system that may be triggered by the comparator signal. This means that to restore the output to zero, the input polarity must be reversed by 10 mV beyond the original threshold.

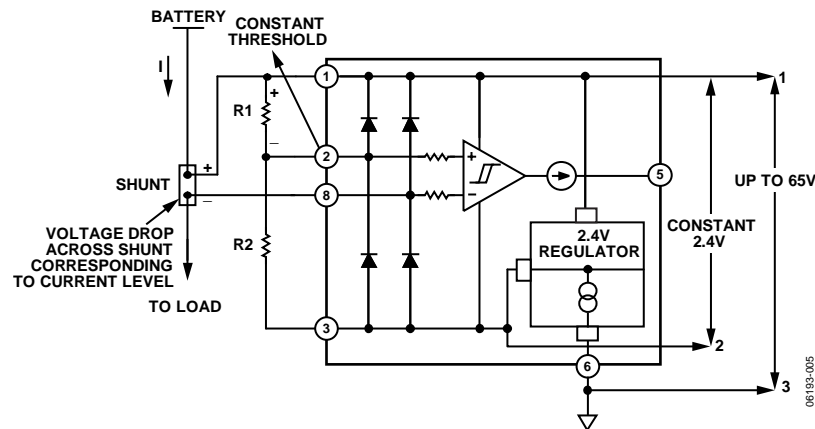

Figure 28. Simplified Schematic

COMPARATOR OFFSET AND HYSTERESIS

The AD8214 features built-in hysteresis to minimize the effects of noise in the system. There is also a small offset at the input of the device.



Figure 29. Hysteresis and Input Offset Voltage Definition

Figure 29 shows the relationship between the input voltage and the output current. The horizontal axis represents the voltage between the positive (+IN) and negative (-IN) inputs of the AD8214. The vertical axis shows the output current for a given input voltage.

V_{TH} represents the point where the inputs are at the same voltage level (+IN = -IN). The output of the AD8214 remains low (V_{OL}) provided (-IN) is at a higher voltage potential than (+IN). As the input voltage transitions to +IN > -IN, the output switches states. Under ideal conditions, the output is expected to change states at exactly V_{TH} . In practice, the output switches when the inputs are equal \pm a small offset voltage (V_{OS}).

Once the output switches from low to high, it remains in this state until the input voltage falls below the hysteresis voltage. Typically, this occurs when +IN is 10 mV below -IN.

SETTING THE INPUT THRESHOLD VOLTAGE

The AD8214 features a 2.4 V series regulator, which can be used to set a reference threshold voltage with two external resistors. The resistors constitute a voltage divider, the middle point of which connects to +IN. The total voltage across the resistors is always 2.4 V. (See Figure 28 for proper resistor placement.) The

values for these resistors can be chosen based on the desired threshold voltage using the equation:

$$\left(\frac{2.4}{R1+R2} \right) \times R1 = V_{TH(+IN)} \quad (1)$$

For proper operation it is recommended that the internal 2.4 V regulator not be loaded down by using small R1 and R2 values. Figure 11 shows the proper range for the total series resistance.

INPUT-REFERRED DYNAMIC ERROR

Frequently, the dynamics of comparators are specified in terms of propagation delay of the response at the output to an input pulse crossing the threshold between two overload states. For this measurement, the rise time of the input pulse is negligible compared to the comparator propagation delay. In the case of the AD8214, this propagation delay is typically 100 ns, when the input signal is a fast step.

The primary purpose of the AD8214 is to monitor for over-current conditions in a system. It is much more common that in such systems, the current in the path increases slowly; therefore, the transition between two input overload conditions around the threshold is slow relative to the propagation delay. In some cases, this transition can be so slow that the time from the actual threshold crossing to the output signal switching states is longer than the specified propagation delay, due to the comparator dynamics.

If the voltage at the input of the AD8214 is crossing the set threshold at a rate ≤ 100 mV/ μ s, the output switches states before the threshold voltage has been exceeded by 15 mV.

Therefore, if the input signal is changing so slowly that the propagation delay is affected, the error that accumulates at the input while waiting for the output response is proportionately smaller and, typically, less than 15 mV for ramp rates ≤ 100 mV/ μ s.

APPLICATIONS

TYPICAL SETUP AND CALCULATIONS

The key feature of the AD8214 is its ability to detect an overcurrent condition on the high side of the rail and provide a signal in less than 100 ns. This performance protects expensive loads, FETs, and shunt resistors in a variety of systems and applications. This section details a typical application in which the normal current in the system is less ≤ 10 A and an overcurrent detection is necessary when 15 A is detected in the path.

If we assume a shunt resistance (R_{SHUNT}) of 0.005Ω and a common-mode voltage range of 5 V to 65 V, the typical voltage across the shunt resistor is

$$10 \text{ A} \times 0.005 \Omega = 50 \text{ mV}$$

The voltage drop across the shunt resistor, in the case of an overcurrent condition is

$$15 \text{ A} \times 0.005 \Omega = 75 \text{ mV}$$

The threshold voltage, must therefore be set at 75 mV, corresponding to the overcurrent condition. R1 and R2 can be selected based on this 75 mV threshold at the positive input of the comparator.

A low load current across the regulator corresponds to optimal regulator performance; therefore, the series resistance of R1 and R2 must be relatively large. For this case, the total resistance can be set as

$$R1 + R2 = 200 \text{ k}\Omega$$

To have a 75 mV drop across R1, the following calculations apply:

$$\frac{2.4 \text{ V}}{200 \text{ k}\Omega} = 12 \mu\text{A}$$

$$\frac{75 \text{ mV}}{12 \mu\text{A}} = 6.25 \text{ k}\Omega = R1$$

$$R2 = (200 \text{ k}\Omega - R1) = 193.75 \text{ k}\Omega$$

The values for R1 and R2 are set; correspondingly, the threshold voltage at +IN is set at 75 mV.

Under normal operating conditions, the current is 10 A or less, corresponding to a maximum voltage drop across the shunt of 50 mV. This means that the negative input of the comparator is 50 mV below the battery voltage. Since the positive input is 75 mV below the battery voltage, the negative input is at a higher potential than the positive; therefore, the output of the AD8214 is low.

If the current increases to 15 A, the drop across the shunt is 75 mV. As the current continues to increase, the positive input of the comparator reaches a higher potential than the negative, and the output of the AD8214 switches from low to high. The input-to-output response of the AD8214 is less than 100 ns. The output resistor in this case is selected so that the logic level high signal is 3.3 V.

The output changes states from low to high in the case of an overcurrent condition. However, the input offset voltage is typically 1 mV; therefore, this must be taken into consideration when choosing the threshold voltage. When the current in the system drops back down to normal levels, the AD8214 changes states from high to low. However, due to the built-in 10 mV hysteresis, the voltage at (-IN) must be 10 mV higher than the threshold for the output to change states from high to low. This built-in hysteresis is intended to prevent input chatter as well as any false states.

Table 4 shows typical resistors combinations that can be used to set an input threshold voltage. Numbers are based on a $2.43 \text{ V } V_{REG}$.

Table 4.

Threshold (mV)	R1 (k Ω)	R2 (k Ω)
30	1.5	120
50	1.6	75
60	2	80
75	2.4	75
110	8.06	169



Figure 30. Typical Application

HIGH SIDE OVERCURRENT DETECTION

The AD8214 is useful for many automotive applications using the load configuration shown in Figure 31. Because the part powers directly from the battery voltage, the shunt resistor must be on the high side. The AD8214 monitors the current in the path as long as the battery voltage is between 5 V and 65 V. If the current

reaches an undesirable level that corresponds to the user-selected threshold, the output of the AD8214 switches states in less than 100 ns. The microcontroller, analog-to-digital converter, or FET driver can be directly notified of this condition.



Figure 31. High Side Overcurrent Protection

OUTLINE DIMENSIONS

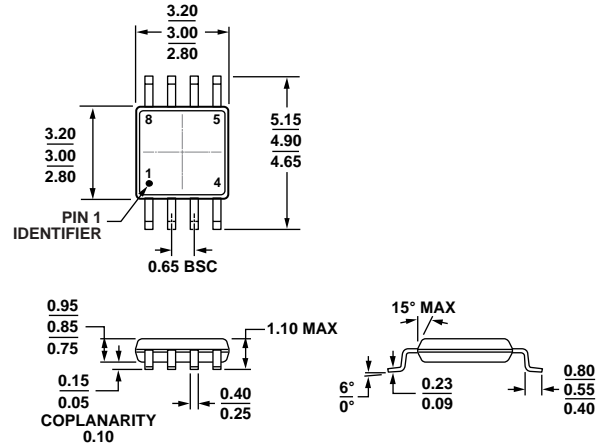

COMPLIANT TO JEDEC STANDARDS MO-187-AA

Figure 32. 8-Lead Mini Small Outline Package [MSOP]
(RM-8)

Dimensions shown in millimeters

10-07-2008-B

ORDERING GUIDE

Model ^{1, 2}	Temperature Range	Package Description	Package Option	Branding
AD8214ARMZ	-40°C to +125°C	8-Lead MSOP	RM-8	HON
AD8214ARMZ-RL	-40°C to +125°C	8-Lead MSOP, 13" Tape and Reel	RM-8	HON
AD8214ARMZ-R7	-40°C to +125°C	8-Lead MSOP, 7" Tape and Reel	RM-8	HON
AD8214WYRMZ	-40°C to +125°C	8-Lead MSOP	RM-8	Y2E
AD8214WYRMZ-RL	-40°C to +125°C	8-Lead MSOP, 13" Tape and Reel	RM-8	Y2E
AD8214WYRMZ-R7	-40°C to +125°C	8-Lead MSOP, 7" Tape and Reel	RM-8	Y2E

¹ Z = RoHS Compliant Part.

² W = Qualified for Automotive Applications.

AUTOMOTIVE PRODUCTS

The AD8214W models are available with controlled manufacturing to support the quality and reliability requirements of automotive applications. Note that these automotive models may have specifications that differ from the commercial models; therefore, designers should review the Specifications section of this data sheet carefully. Only the automotive grade products shown are available for use in automotive applications. Contact your local Analog Devices account representative for specific product ordering information and to obtain the specific Automotive Reliability reports for these models.

NOTES

NOTES

Данный компонент на территории Российской Федерации

Вы можете приобрести в компании MosChip.

Для оперативного оформления запроса Вам необходимо перейти по данной ссылке:

<http://moschip.ru/get-element>

Вы можете разместить у нас заказ для любого Вашего проекта, будь то серийное производство или разработка единичного прибора.

В нашем ассортименте представлены ведущие мировые производители активных и пассивных электронных компонентов.

Нашей специализацией является поставка электронной компонентной базы двойного назначения, продукции таких производителей как XILINX, Intel (ex.ALTERA), Vicor, Microchip, Texas Instruments, Analog Devices, Mini-Circuits, Amphenol, Glenair.

Сотрудничество с глобальными дистрибьюторами электронных компонентов, предоставляет возможность заказывать и получать с международных складов практически любой перечень компонентов в оптимальные для Вас сроки.

На всех этапах разработки и производства наши партнеры могут получить квалифицированную поддержку опытных инженеров.

Система менеджмента качества компании отвечает требованиям в соответствии с ГОСТ Р ИСО 9001, ГОСТ РВ 0015-002 и ЭС РД 009

Офис по работе с юридическими лицами:

105318, г.Москва, ул.Щербаковская д.3, офис 1107, 1118, ДЦ «Щербаковский»

Телефон: +7 495 668-12-70 (многоканальный)

Факс: +7 495 668-12-70 (доб.304)

E-mail: info@moschip.ru

Skype отдела продаж:

moschip.ru

moschip.ru_4

moschip.ru_6

moschip.ru_9