

Poke-Home: Single Vertical Contact

18-24 AWG: WTB

Series 9296



AVX continues to develop innovative connectors for the industrial electronics market that provide significant benefits over existing, outdated connector solutions. The latest release is single vertical Wire-to-Board (WTB) contacts that provide cost effective, yet robust discrete wire termination without the expense of an insulator and assembly costs. This new family of top and bottom entry contacts compliments the existing vertical poke home connectors already on the market, providing a lower cost solution without jeopardizing performance.

The new contacts support both solid and stranded wires ranging from 24AWG down to 18AWG and current ratings as high as 12 amps. The set of four contacts provide both top and bottom entry for FR4 and metal core printed circuit boards.

APPLICATIONS

- Machine Controls: motors, drives, solenoids, sensors, fans and pumps
- Commercial Buildings: controls, security, fire and sensors
- Smart Grid: meters, breakers and panels
- SSL/LED; bulbs, fixtures, signage and streetlights

FEATURES AND BENEFITS

- Dual Beam contact provides maximum mechanical stability and wire retention
- Tape and reel packaged for automated SMT placement
- Staged current rating based on AWG, maximum is 12A (18AWG)
- Increased functionality with the single contact placement: multiple contacts and/or specific individual locations

ELECTRICAL

- Voltage Rating: Based on placement distance
- Current Rating: See matrix below

ENVIRONMENTAL

- Operating Temperature: -40°C to +125°C

MECHANICAL

- Contact Material: Phosphor Bronze
- Contact Plating: Tin over Nickel
- Durability: 5 Cycles

HOW TO ORDER

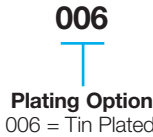

Code	Contact Location	Wire Insertion Direction	Recommended For Board Type	Wire Gauges
103	Top Side	Bottom Entry	FR4	18AWG - 24 AWG
113	Through Board	Top Entry	FR4	18AWG - 24 AWG
123	Top Side	Bottom Entry	Metal Clad	18AWG - 24 AWG
133	Through Board	Top Entry	Metal Clad	18AWG - 24 AWG

CURRENT RATING

18AWG	20AWG	22AWG	24AWG
12A	10A	8A	7A

Poke-Home: Single Vertical Contact

18-24 AWG: WTB



Series 9296

70-9296-001-103-006

9296 VERTICAL MOUNT SMT CONTACT TOP SIDE CONTACT – BOTTOM ENTRY WIRE (FR4 BOARD)



SUGGESTED PCB LAYOUT



NOTES:

1. CONTACT MOUNTS ON TOP SIDE OF BOARD, WIRE INSERTED FROM UNDER-SIDE OF BOARD.
2. STYLE RECOMMENDED FOR FR4 BOARDS WHERE MINIMUM CLEARANCE REQUIRED TO CONTACT AND MOUNTING PADS.
3. FOR FURTHER INFORMATION REFER TO ELCO SPECIFICATION 201-01-143 AND APPLICATION NOTES 201-01-150.
4. MATERIAL: TIN PLATED PHOSPHOR BRONZE.
5. HOLE FOR WIRE INSERTION.
6. PACING IN TAPE AND REEL, 2000 PIECES PER REEL.
7. FOR WIRE TRIM DETAILS REFER TO PAGE 6.

PACKING DETAILS

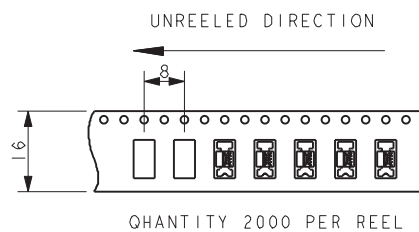

330mm DIAMETER REEL



Poke-Home: Single Vertical Contact

18-24 AWG: WTB



Series 9296

70-9296-001-113-006

9296 VERTICAL MOUNT SMT CONTACT THROUGH BOARD CONTACT – TOP ENTRY WIRE (FR4 BOARD)

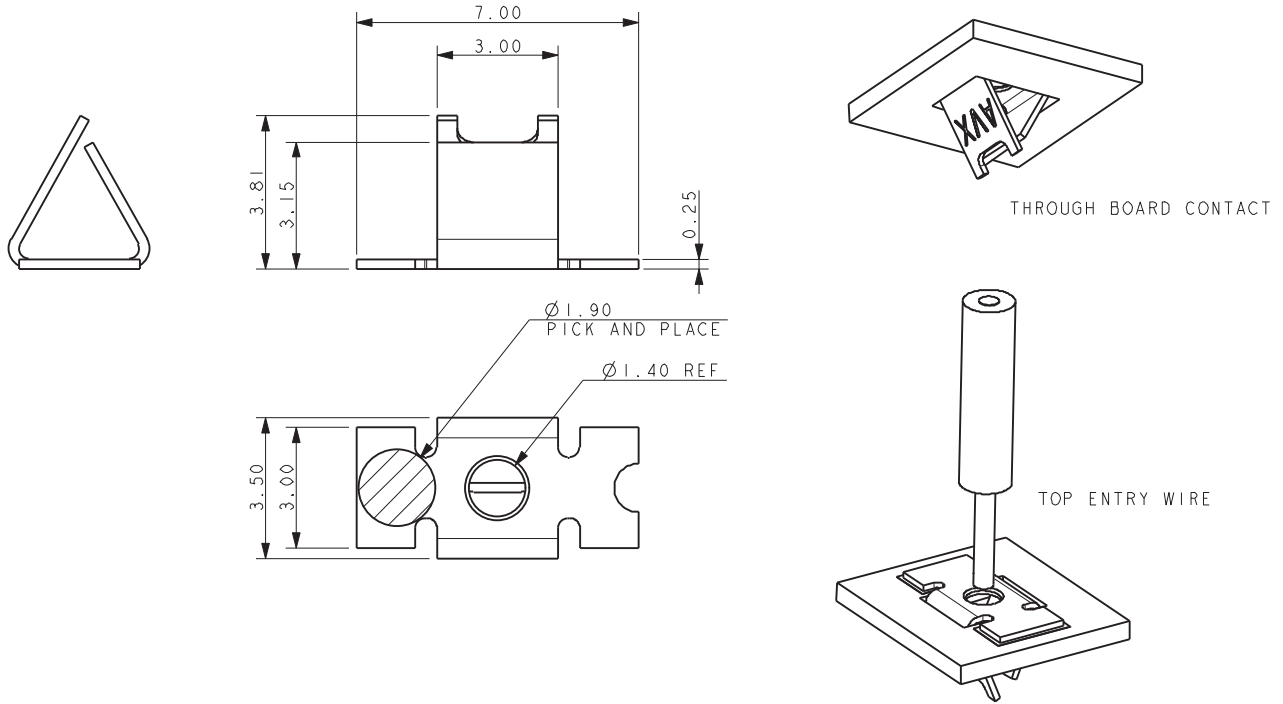

SUGGESTED PCB LAYOUT

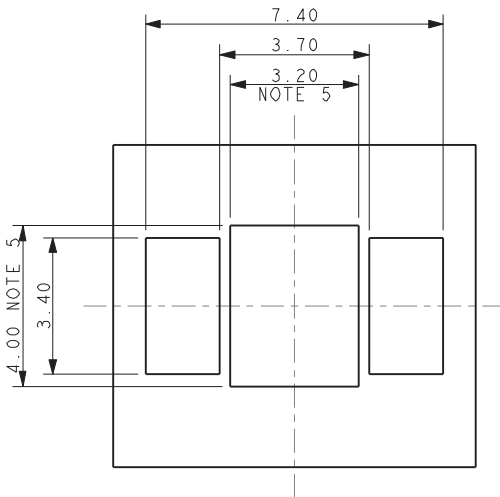

NOTES:

1. CONTACT MOUNTS THROUGH THE BOARD, WIRE INSERTED FROM TOP SIDE OF BOARD.
2. STYLE RECOMMENDED FOR FR4 BOARDS WHERE MINIMUM CLEARANCE REQUIRED TO CONTACT AND MOUNTING PADS.
3. FOR FURTHER INFORMATION REFER TO ELCO SPECIFICATION 201-01-143 AND APPLICATION NOTES 201-01-150.
4. MATERIAL: TIN PLATED PHOSPHOR BRONZE.
5. HOLE DIMENSIONS FOR CONTACT.
6. PACING IN TAPE AND REEL, 2000 PIECES PER REEL.
7. FOR WIRE TRIM DETAILS REFER TO PAGE 6.

PACKING DETAILS

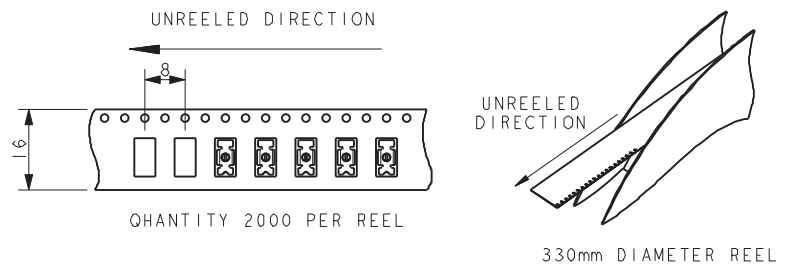

Poke-Home: Single Vertical Contact

18-24 AWG: WTB



Series 9296

70-9296-001-123-006

9296 VERTICAL MOUNT SMT CONTACT

TOP SIDE CONTACT – BOTTOM ENTRY WIRE (METAL BOARD)



SUGGESTED PCB LAYOUT



NOTES:

1. CONTACT MOUNTS ON TOP SIDE OF BOARD, WIRE INSERTED FROM UNDERSIDE OF BOARD.
2. STYLE RECOMMENDED FOR METAL CLAD BOARDS WHERE MAXIMUM CLEARANCE REQUIRED TO CONTACT AND MOUNTING PADS.
3. FOR FURTHER INFORMATION REFER TO ELCO SPECIFICATION 201-01-143 AND APPLICATION NOTES 201-01-150.
4. MATERIAL: TIN PLATED PHOSPHOR BRONZE.
5. HOLE FOR WIRE INSERTION.
6. PACING IN TAPE AND REEL, 1600 PIECES PER REEL.
7. FOR WIRE TRIM DETAILS REFER TO PAGE 6.

PACKING DETAILS



Poke-Home: Single Vertical Contact

18-24 AWG: WTB



Series 9296

70-9296-001-133-006

9296 VERTICAL MOUNT SMT CONTACT THROUGH BOARD CONTACT – TOP ENTRY WIRE (METAL BOARD)



THROUGH BOARD CONTACT



TOP ENTRY WIRE

SUGGESTED PCB LAYOUT



NOTES:

1. CONTACT MOUNTS THROUGH THE BOARD, WIRE INSERTED FROM TOP SIDE OF BOARD.
2. STYLE RECOMMENDED FOR METAL CLAD BOARDS WHERE ADDITIONAL CLEARANCE REQUIRED TO CONTACT AND MOUNTING PADS.
3. FOR FURTHER INFORMATION REFER TO ELCO SPECIFICATION 201-01-143 AND APPLICATION NOTES 201-01-150.
4. MATERIAL: TIN PLATED PHOSPHOR BRONZE.
5. HOLE DIMENSIONS FOR CONTACT.
6. PACING IN TAPE AND REEL, 2000 PIECES PER REEL.
7. FOR WIRE TRIM DETAILS REFER TO PAGE 6.

PACKING DETAILS

UNREELLED DIRECTION



QUANTITY 2000 PER REEL

UNREELLED DIRECTION

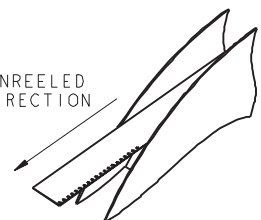

330mm DIAMETER REEL



Poke-Home: Single Vertical Contact

18-24 AWG: WTB



Series 9296

9296 VERTICAL MOUNT SMT CONTACT WIRE TRIM DETAILS

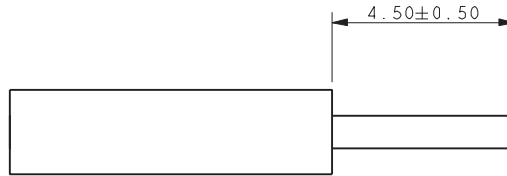

WIRE STRIP LENGTH, ALL STYLES



70-9296-001-103-006



70-9296-001-113-006



70-9296-001-123-006



70-9296-001-133-006

NOTES:

1. FOR FULL ASSEMBLY PROCEDURE REFER TO APPLICATION NOTES 201-01-150.
2. THE SAME WIRE STRIP LENGTH APPLIES TO ALL STYLES.
3. STRANDED WIRES SHOULD BE TWISTED TO PREVENT SINGLE STRANDS BECOMING DETACHED WHEN INSERTED INTO CONTACT.

Данный компонент на территории Российской Федерации

Вы можете приобрести в компании MosChip.

Для оперативного оформления запроса Вам необходимо перейти по данной ссылке:

<http://moschip.ru/get-element>

Вы можете разместить у нас заказ для любого Вашего проекта, будь то серийное производство или разработка единичного прибора.

В нашем ассортименте представлены ведущие мировые производители активных и пассивных электронных компонентов.

Нашей специализацией является поставка электронной компонентной базы двойного назначения, продукции таких производителей как XILINX, Intel (ex.ALTERA), Vicor, Microchip, Texas Instruments, Analog Devices, Mini-Circuits, Amphenol, Glenair.

Сотрудничество с глобальными дистрибьюторами электронных компонентов, предоставляет возможность заказывать и получать с международных складов практически любой перечень компонентов в оптимальные для Вас сроки.

На всех этапах разработки и производства наши партнеры могут получить квалифицированную поддержку опытных инженеров.

Система менеджмента качества компании отвечает требованиям в соответствии с ГОСТ Р ИСО 9001, ГОСТ РВ 0015-002 и ЭС РД 009

Офис по работе с юридическими лицами:

105318, г.Москва, ул.Щербаковская д.3, офис 1107, 1118, ДЦ «Щербаковский»

Телефон: +7 495 668-12-70 (многоканальный)

Факс: +7 495 668-12-70 (доб.304)

E-mail: info@moschip.ru

Skype отдела продаж:

moschip.ru

moschip.ru_4

moschip.ru_6

moschip.ru_9