

STRADA-SQ-T3

IESNA Type III (medium) beam for roads that are equal to or wider than mounting height. Version with location pins. Assembly with installation tape.

TECHNICAL SPECIFICATIONS:

Dimensions	25.0 mm
Height	8.4 mm
Fastening	tape, pin
ROHS compliant	yes ⓘ

MATERIAL SPECIFICATIONS:

Component	Type	Material	Colour	Finish
STRADA-SQ-T3	Single lens	PMMA	clear	
ROSE-TAPE	Tape	PU tape	black	

ORDERING INFORMATION:

Component	Qty in box	MOQ	MPQ	Box weight (kg)
CA13688_STRADA-SQ-T3 » Box size:			98	7.8



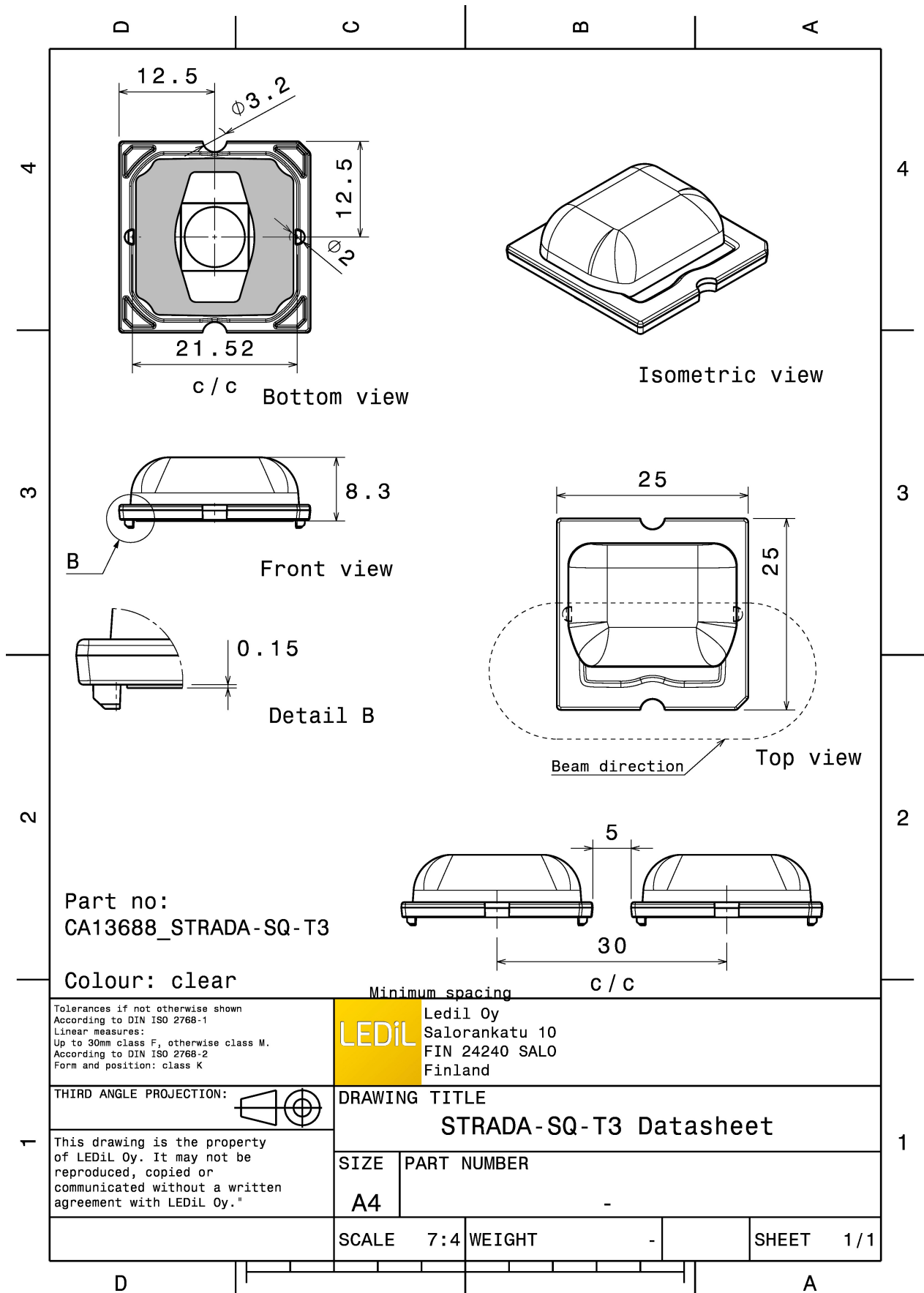

PHOTOMETRIC DATA (MEASURED):

CREE

LED XHP50
 FWHM Asymmetric
 Efficiency 94 %
 Peak intensity 0.7 cd/lm
 LEDs/each optic 1
 Light colour White
 Required components:

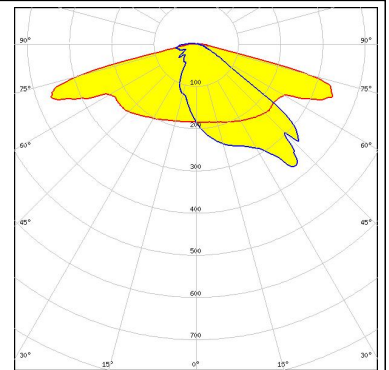

LUMILEDS

LED LUXEON M/MX
 FWHM Asymmetric
 Efficiency 92 %
 Peak intensity 0.5 cd/lm
 LEDs/each optic 1
 Light colour White
 Required components:

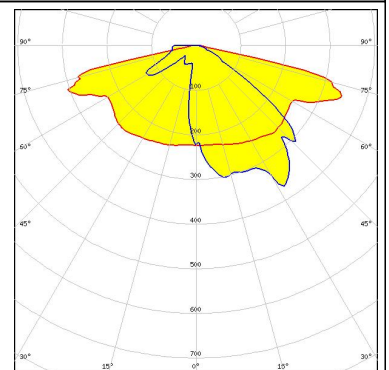

LUMILEDS

LED LUXEON MZ
 FWHM Asymmetric
 Efficiency 91 %
 Peak intensity 0.8 cd/lm
 LEDs/each optic 1
 Light colour White
 Required components:

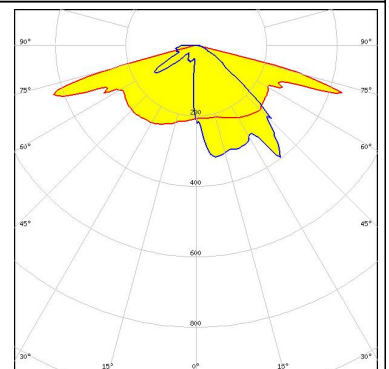

LUMILEDS

LED LUXEON TX
 FWHM Asymmetric
 Efficiency 93 %
 Peak intensity 1.1 cd/lm
 LEDs/each optic 1
 Light colour White
 Required components:

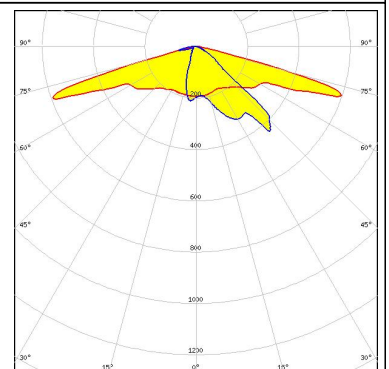

PHOTOMETRIC DATA (MEASURED):

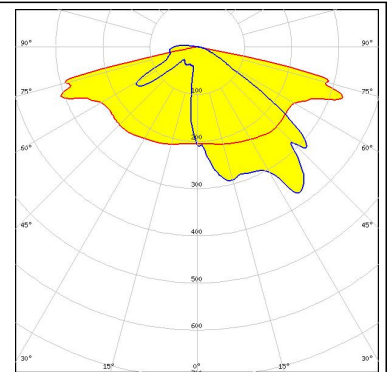
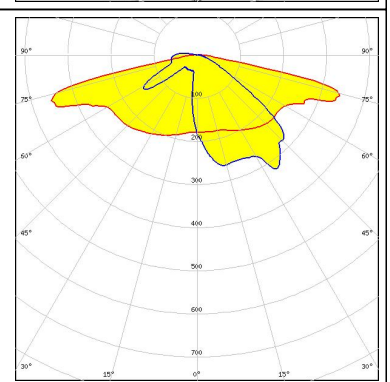
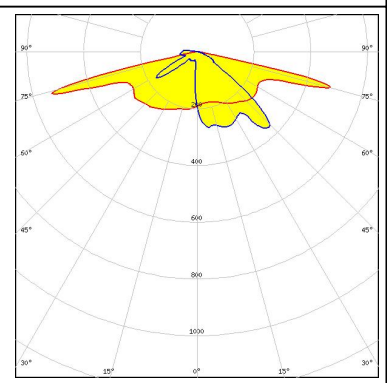
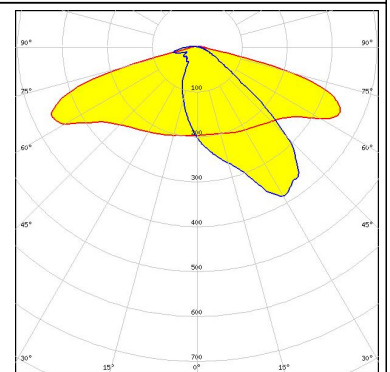
<p>LUMILEDS</p> <p>LED LUXEON XR-M linear 1x3, 1x4, 1x5</p> <p>FWHM Asymmetric</p> <p>Efficiency 93 %</p> <p>Peak intensity 0.5 cd/lm</p> <p>LEDs/each optic 1</p> <p>Light colour White</p> <p>Required components:</p>	
<p>NICHIA</p> <p>LED NV4x144A</p> <p>FWHM Asymmetric</p> <p>Efficiency 91 %</p> <p>Peak intensity 0.6 cd/lm</p> <p>LEDs/each optic 1</p> <p>Light colour White</p> <p>Required components:</p>	
<p>NICHIA</p> <p>LED NVSW319B</p> <p>FWHM Asymmetric</p> <p>Efficiency 91 %</p> <p>Peak intensity 1 cd/lm</p> <p>LEDs/each optic 1</p> <p>Light colour White</p> <p>Required components:</p>	
<p>OSRAM Opto Semiconductors</p> <p>LED Duris S10</p> <p>FWHM Asymmetric</p> <p>Efficiency 92 %</p> <p>Peak intensity 0.6 cd/lm</p> <p>LEDs/each optic 1</p> <p>Light colour White</p> <p>Required components:</p>	

PHOTOMETRIC DATA (MEASURED):

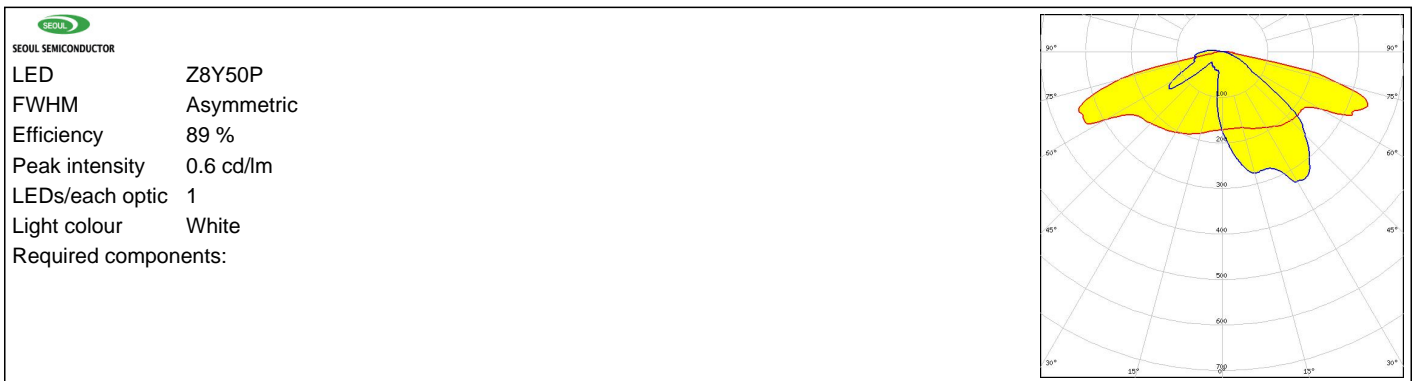

PHOTOMETRIC DATA (SIMULATED):



LED MHB-A/B
 FWHM Asymmetric
 Efficiency 89 %
 Peak intensity 0.5 cd/lm
 LEDs/each optic 1
 Light colour White
 Required components:

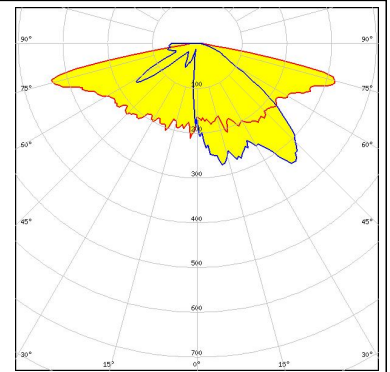

LED MK-R
 FWHM Asymmetric
 Efficiency 90 %
 Peak intensity 0.6 cd/lm
 LEDs/each optic 1
 Light colour White
 Required components:

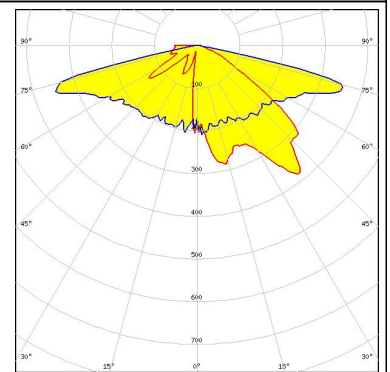

LED XP-G3
 FWHM Asymmetric
 Efficiency 89 %
 Peak intensity 0.8 cd/lm
 LEDs/each optic 1
 Light colour White
 Required components:

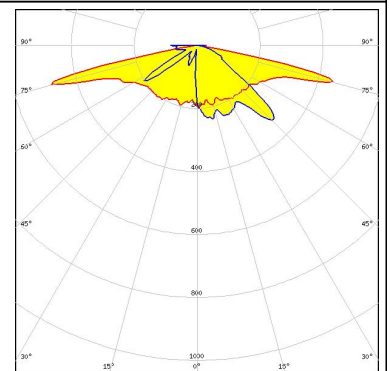

LED NVSxx19B/NVSxx19C
 FWHM Asymmetric
 Efficiency 90 %
 LEDs/each optic 1
 Light colour White
 Required components:

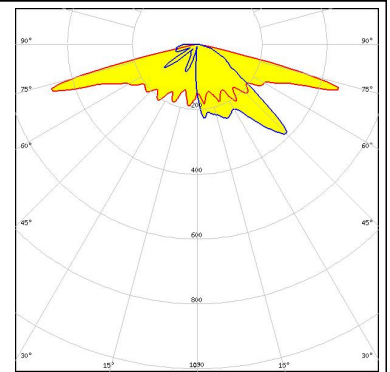

PHOTOMETRIC DATA (SIMULATED):

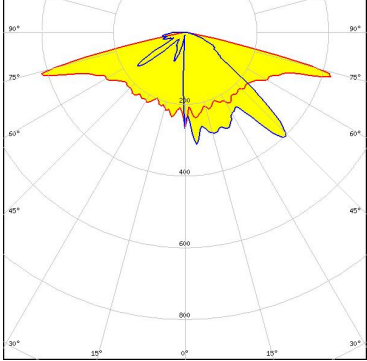
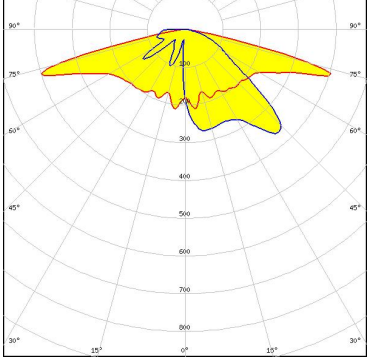
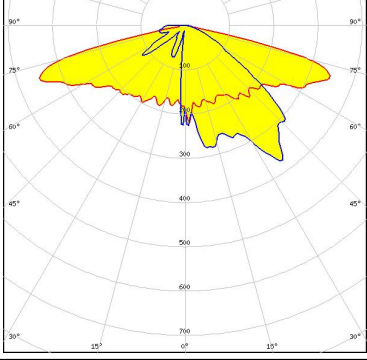
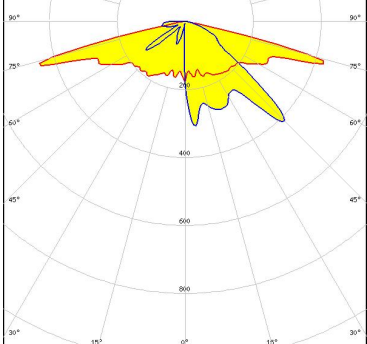
<p>OSRAM Opto Semiconductors</p> <p>LED OSCONIQ P 3737 (2W version)</p> <p>FWHM Asymmetric</p> <p>Efficiency 91 %</p> <p>Peak intensity 0.8 cd/lm</p> <p>LEDs/each optic 1</p> <p>Light colour White</p> <p>Required components:</p>	
<p>OSRAM Opto Semiconductors</p> <p>LED OSCONIQ P 3737 (3W version)</p> <p>FWHM Asymmetric</p> <p>Efficiency 94 %</p> <p>Peak intensity 0.7 cd/lm</p> <p>LEDs/each optic 1</p> <p>Light colour White</p> <p>Required components:</p>	
<p>OSRAM Opto Semiconductors</p> <p>LED OSCONIQ P 7070</p> <p>FWHM Asymmetric</p> <p>Efficiency 89 %</p> <p>Peak intensity 0.6 cd/lm</p> <p>LEDs/each optic 1</p> <p>Light colour White</p> <p>Required components:</p>	
<p>OSRAM Opto Semiconductors</p> <p>LED OSLOM Square CSSRM2/CSSRM3</p> <p>FWHM Asymmetric</p> <p>Efficiency 91 %</p> <p>Peak intensity 0.8 cd/lm</p> <p>LEDs/each optic 1</p> <p>Light colour White</p> <p>Required components:</p>	

GENERAL INFORMATION:

NOTE: The typical beam angle will be changed by different color, chip size and chip position tolerance. The typical total beam angle is the full angle measured where the luminous intensity is half of the peak value.

MATERIALS:

As part of our continuous research and improvement processes, and to ensure the best possible quality and availability of our products, LEDiL reserves the right to change material grades without notice.

PRODUCT DATA USER AGREEMENT AND DISCLAIMER:

The measured data in the provided downloadable LEDiL Product Datasheets and Mechanical 2D-Drawings is rounded and provided as reference for planning. LEDiL Oy's optical specifications have been verified by conducting performance testing of the products in accordance with the company's quality system. The reported data are averaged results of multiple measurements with typical variation. LEDiL Oy reserves the right to without prior notification make changes and improvements to its products.

LEDiL Oy assumes neither warranty, nor guarantee nor any other liability of any kind for the contents and correctness of the provided data. The provided data has been generated with highest diligence but the provided data may in reality not represent the complete possible variation range of all intrinsic parameters. Therefore, in certain cases a deviation from the provided data could occur.

LEDiL Oy reserves the right to undertake technical changes of its products without further notification which could lead to changes in the provided data. LEDiL Oy assumes no liability of any kind for the possible deviation from any provided data or any other damage resulting from the usage of the provided data.

The user agrees to this disclaimer and user agreement with the download or usage of the provided files.

LEDiL Oy

Joensuunkatu 13
FI-24240 SALO
Finland

LEDiL Inc.

228 West Page Street
Suite D
Sycamore IL 60178
USA

Local sales and technical support

[www.ledil.com/
where_to_buy](http://www.ledil.com/where_to_buy)

Shipping locations

Salo, Finland
Hong Kong, China

Distribution Partners

[www.ledil.com/
where_to_buy](http://www.ledil.com/where_to_buy)

Данный компонент на территории Российской Федерации

Вы можете приобрести в компании MosChip.

Для оперативного оформления запроса Вам необходимо перейти по данной ссылке:

<http://moschip.ru/get-element>

Вы можете разместить у нас заказ для любого Вашего проекта, будь то серийное производство или разработка единичного прибора.

В нашем ассортименте представлены ведущие мировые производители активных и пассивных электронных компонентов.

Нашей специализацией является поставка электронной компонентной базы двойного назначения, продукции таких производителей как XILINX, Intel (ex.ALTERA), Vicor, Microchip, Texas Instruments, Analog Devices, Mini-Circuits, Amphenol, Glenair.

Сотрудничество с глобальными дистрибьюторами электронных компонентов, предоставляет возможность заказывать и получать с международных складов практически любой перечень компонентов в оптимальные для Вас сроки.

На всех этапах разработки и производства наши партнеры могут получить квалифицированную поддержку опытных инженеров.

Система менеджмента качества компании отвечает требованиям в соответствии с ГОСТ Р ИСО 9001, ГОСТ РВ 0015-002 и ЭС РД 009

Офис по работе с юридическими лицами:

105318, г.Москва, ул.Щербаковская д.3, офис 1107, 1118, ДЦ «Щербаковский»

Телефон: +7 495 668-12-70 (многоканальный)

Факс: +7 495 668-12-70 (доб.304)

E-mail: info@moschip.ru

Skype отдела продаж:

moschip.ru

moschip.ru_4

moschip.ru_6

moschip.ru_9