

Mini Half-Watt SMD 3.5mm (120° Viewing Angle)



OVS5MxBCR4 Series

Features:

- Compact Package Outline of 3.5 x 3.5 x 1.2 mm
- Robust energy-efficient design with long operating life
- Low thermal resistance
- Exceptional spatial uniformity
- Compatible to IR reflow soldering
- High Lumens output



Description:

The mini-half watt is an energy-efficient packaged LED source that offers high luminance, and a long operating lifespan. This device offers a 120° viewing angle and an ultra-low profile (1.2 mm) making it highly suitable for conventional lighting and specialized applications.

Applications:

- Automotive exterior and interior lighting
- Architectural indoor and outdoor lighting
- General lighting
- Display Backlighting
- Electronic signs and signals

Part Number	Viewing Angle	Emitted Color	Typ. Luminous Flux (lm)	Forward Voltage V_F	Power Dissipation @ 150 mA	Lens Color
OVS5MWBCR4	120	White	50	3.4	0.51 W	Clear
OVS5MWWBCR4		Warm White	30	3.6	0.54 W	
OVS5MBBCR4		Blue	8.2	3.4	0.51 W	
OVS5MGBCR4		Green	22	3.4	0.51 W	

Part Number	Viewing Angle	Emitted Color	Typ. Luminous Intensity (mcd)	Forward Voltage V_F	Power Dissipation @ 150 mA	Lens Color
OVS5MRBCR4	120	Red	7150	2.2	0.33 W	Clear
OVS5MABCR4		Amber	7150	2.2	0.33 W	
OVS5MYBCR4		Yellow	7150	2.2	0.33 W	



DO NOT LOOK DIRECTLY AT LED WITH UNSHIELDED EYES OR DAMAGE TO RETINA MAY

General Note

TT Electronics reserves the right to make changes in product specification without notice or liability. All information is subject to TT Electronics' own data and is considered accurate at time of going to print.

TT Electronics | OPTEK Technology
1645 Wallace Drive, Carrollton, TX 75006 | Ph: +1 972 323 2200
www.ttelectronics.com | www.optekinc.com

Mini Half-Watt SMD 3.5mm (120° Viewing Angle)



OVS5MxBCR4 Series

Electrical Specifications

Absolute Maximum Ratings (T _A = 25° C unless otherwise noted)				
	Red, Amber, Yellow	Green, Blue	White	Warm White
DC Forward Current	200 mA a	180 mA	180 mA	180 mA
Peak Pulsed Forward Current ¹	1000 mA	350 mA	350 mA	350 mA
Reverse Voltage	12V @ 10 uA	Not designed for reverse bias	Not designed for reverse bias	Not designed for reverse bias
Junction Temperature ²	125°C	125°C	125°C	125°C
Power Dissipation	750mW	750mW	750mW	750mW
Storage and Operating Temperature	-40° ~ +100 ° C	-40° ~ +100 ° C	-40° ~ +100 ° C	-40° ~ +100 ° C
ESD (JEDEC-JESD22-A114F)	Class 2	Class 2	Class 2	Class 2
MSL (IPC / JEDEC J-STD-020C)	2a / 672 Hrs	2a / 672 Hrs	2a / 672 Hrs	2a / 672 Hrs

Notes:

1. Pulse width $t_p \leq 10\mu s$, Duty cycle = 0.1
2. Thermal Resistance = 5 C/W

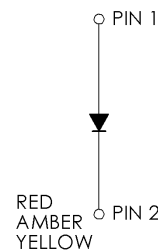
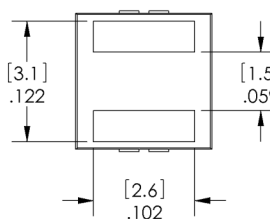
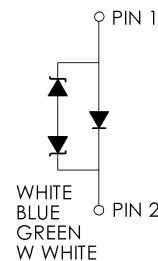
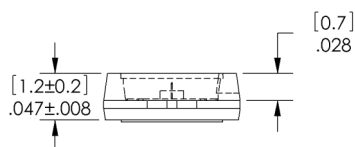
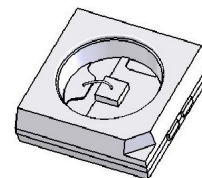
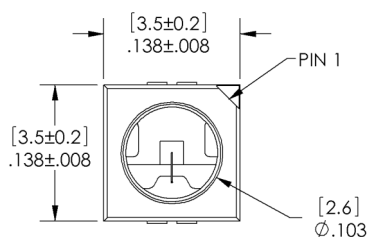

PIN 1	ANODE
PIN 2	CATHODE

DIMENSIONS ARE IN INCHES [MM].

General Note

TT Electronics reserves the right to make changes in product specification without notice or liability. All information is subject to TT Electronics' own data and is considered accurate at time of going to print.

TT Electronics | OPTEK Technology
1645 Wallace Drive, Carrollton, TX 75006 | Ph: +1 972 323 2200
www.ttelectronics.com | www.optekinc.com

Mini Half-Watt SMD 3.5mm (120° Viewing Angle)



OVS5MxBCR4 Series

Optical and Electrical Characteristics - Red, Amber, Yellow ($I_F = 140 \text{ mA}$, $T_A = 25^\circ \text{ C}$)

SYMBOL	PARAMETER	MIN	TYP	MAX	UNITS	
V_F	Forward Voltage	1.9	2.2	2.65	V	
Φ	Luminous Intensity	Red	4500	7150	9000	mcd
		Amber				
		Yellow				
λ_D	Dominant Wavelength	Red	620	625	630	nm
		Amber	610	615	621	
		Yellow	585	590	594	
I_R	Reverse Current @ 12 V	----	10	----	μA	
$2\theta_{\frac{1}{2}}$	50% Power Angle	----	120	----	deg	

Optical and Electrical Characteristics - Blue, Green ($I_F = 150 \text{ mA}$, $T_A = 25^\circ \text{ C}$)

SYMBOL	PARAMETER	MIN	TYP	MAX	UNITS	
V_F	Forward Voltage	3.0	3.4	3.9	V	
Φ	Luminous Flux	Blue	6.3	8.2	10.7	lm
		Green	18.1	22.0	30.6	
λ_D	Dominant Wavelength	Blue	460	465	470	nm
		Green	520	525	535	
$2\theta_{\frac{1}{2}}$	50% Power Angle	----	120	----	deg	

Optical and Electrical Characteristics - White, Warm White ($I_F = 150 \text{ mA}$, $T_A = 25^\circ \text{ C}$)

SYMBOL	PARAMETER	MIN	TYP	MAX	UNITS	
V_F	Forward Voltage	White	3.0	3.4	4.1	V
		Warm White		3.6		
Φ	Luminous Flux	White	30.6	50	67.2	lm
		Warm White	23.5	30	39.8	
$2\theta_{\frac{1}{2}}$	50% Power Angle	----	120	----	deg	

General Note

TT Electronics reserves the right to make changes in product specification without notice or liability. All information is subject to TT Electronics' own data and is considered accurate at time of going to print.

TT Electronics | OPTEK Technology
1645 Wallace Drive, Carrollton, TX 75006 | Ph: +1 972 323 2200
www.ttelectronics.com | www.optekinc.com

Mini Half-Watt SMD 3.5mm (120° Viewing Angle)



OVS5MxBCR4 Series

OVS5MABCR4 (Amber), OVS5MRBCR4 (Red) and OVS5MYBCR4 (Yellow)

Relative Intensity Vs Forward Current

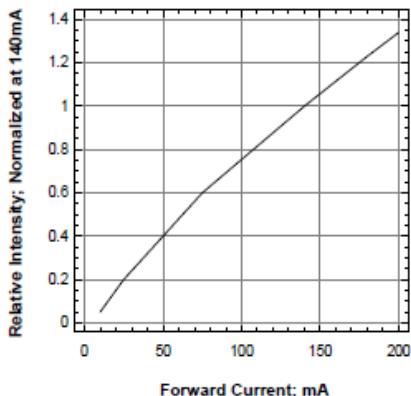

Forward Voltage Vs Forward Current

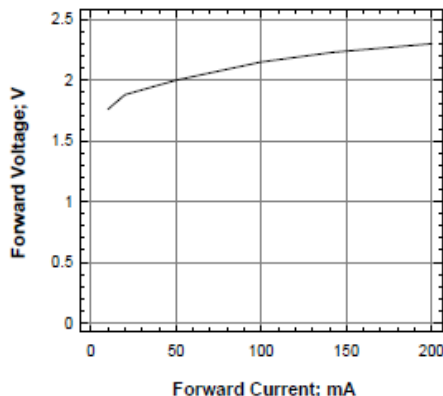

Maximum Current Vs Ambient Temperature

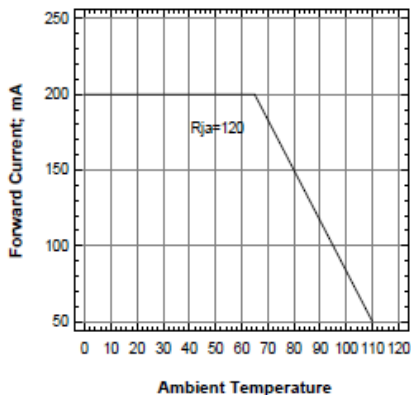

Maximum Current vs Solder-Point Temperature

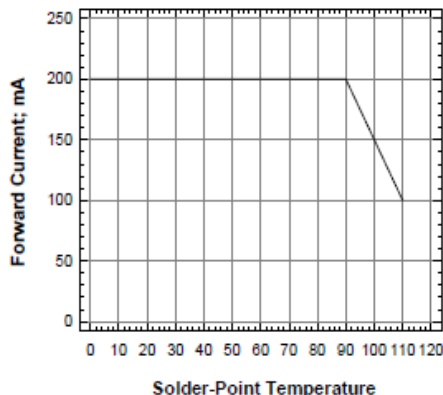

Relative Intensity Vs Wavelength

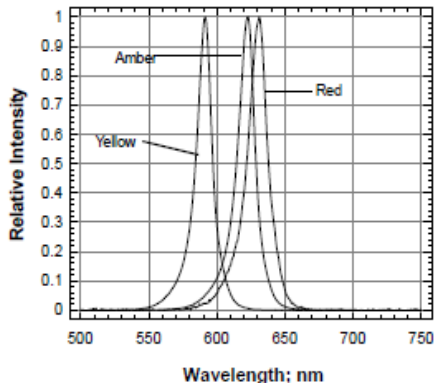

Allowable Forward Current Vs Duty Ratio

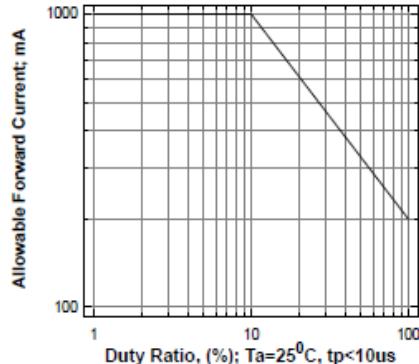

General Note

TT Electronics reserves the right to make changes in product specification without notice or liability. All information is subject to TT Electronics' own data and is considered accurate at time of going to print.

TT Electronics | OPTEK Technology
1645 Wallace Drive, Carrollton, TX 75006 | Ph: +1 972 323 2200
www.ttelectronics.com | www.optekinc.com

Mini Half-Watt SMD 3.5mm (120° Viewing Angle)



OVS5MxBRC4 Series

OVS5MBCR4 (Blue), OVS5MGBCR4 (Green), OVS5MWBCR4 (White) and OVS5MWWBCR4 (Warm White)

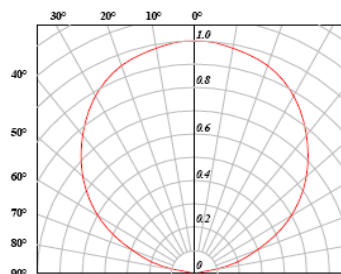
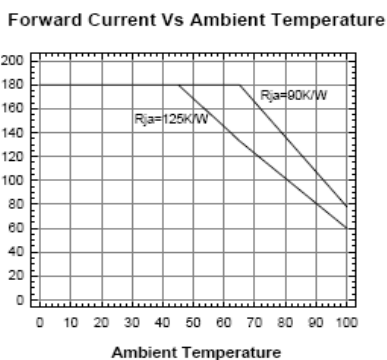
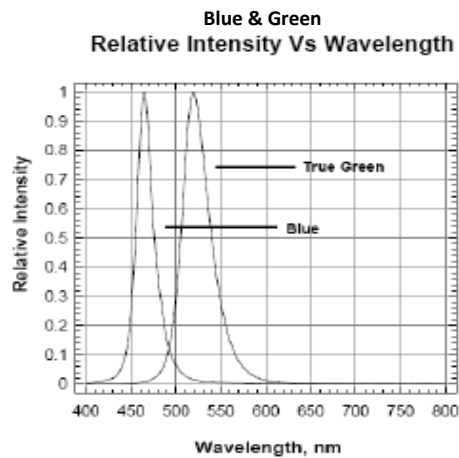
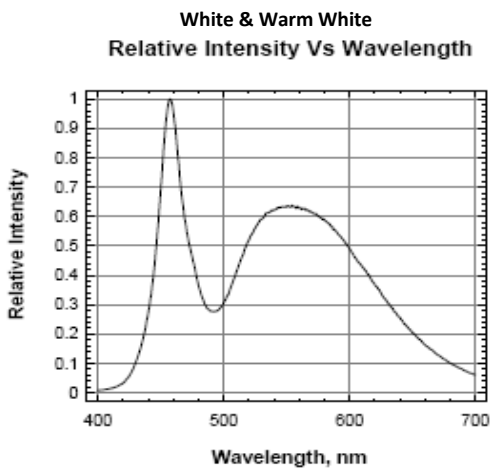
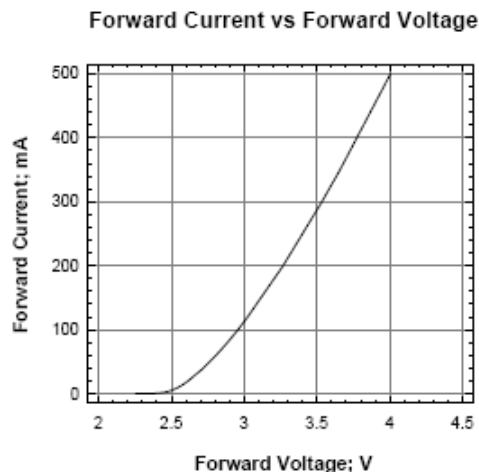
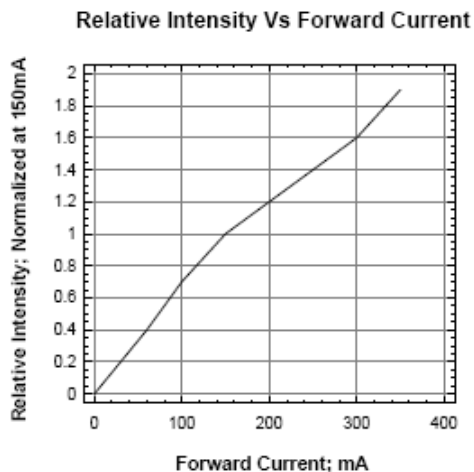

General Note

TT Electronics reserves the right to make changes in product specification without notice or liability. All information is subject to TT Electronics' own data and is considered accurate at time of going to print.

TT Electronics | OPTEK Technology
1645 Wallace Drive, Carrollton, TX 75006 | Ph: +1 972 323 2200
www.ttelectronics.com | www.optekinc.com

Mini Half-Watt SMD 3.5mm (120° Viewing Angle)



OVS5MxBCR4 Series

Solder Pad Design

Note: Metal core circuit board (MCPCB) is highly recommended for high density applications. FR-4 board is recommended for other applications

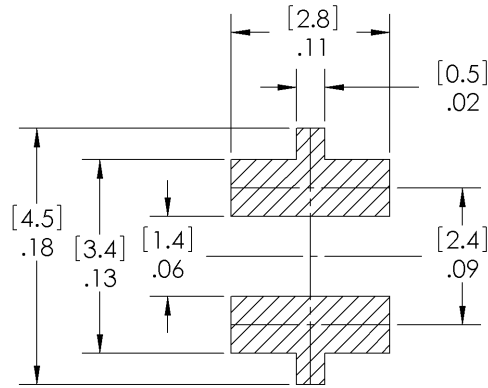

Solder Paste Pattern

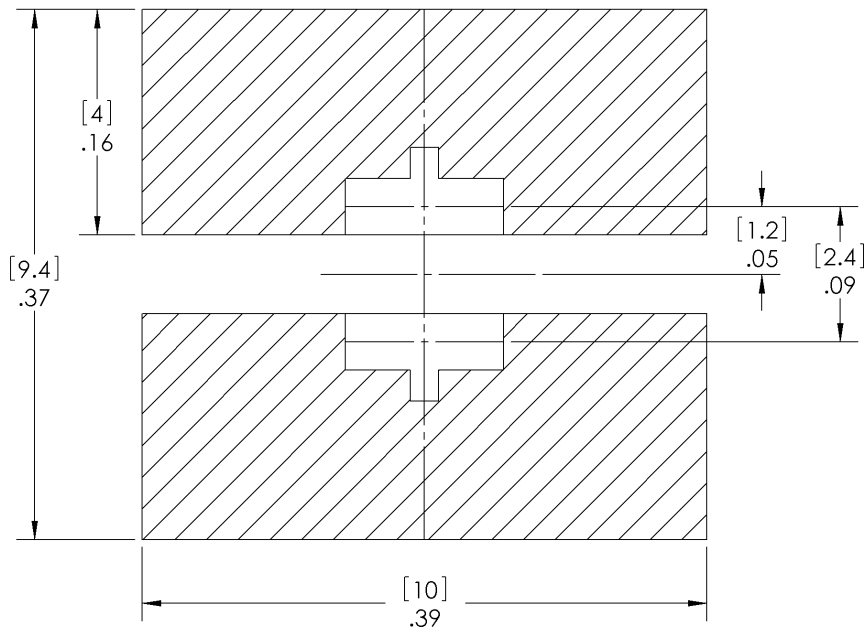

Copper Pattern

General Note

TT Electronics reserves the right to make changes in product specification without notice or liability. All information is subject to TT Electronics' own data and is considered accurate at time of going to print.

TT Electronics | OPTEK Technology
1645 Wallace Drive, Carrollton, TX 75006 | Ph: +1 972 323 2200
www.ttelectronics.com | www.optekinc.com

Mini Half-Watt SMD 3.5mm (120° Viewing Angle)



OVS5MxBCR4 Series

Recommended Sn-Pb IR-Reflow Soldering Profile.

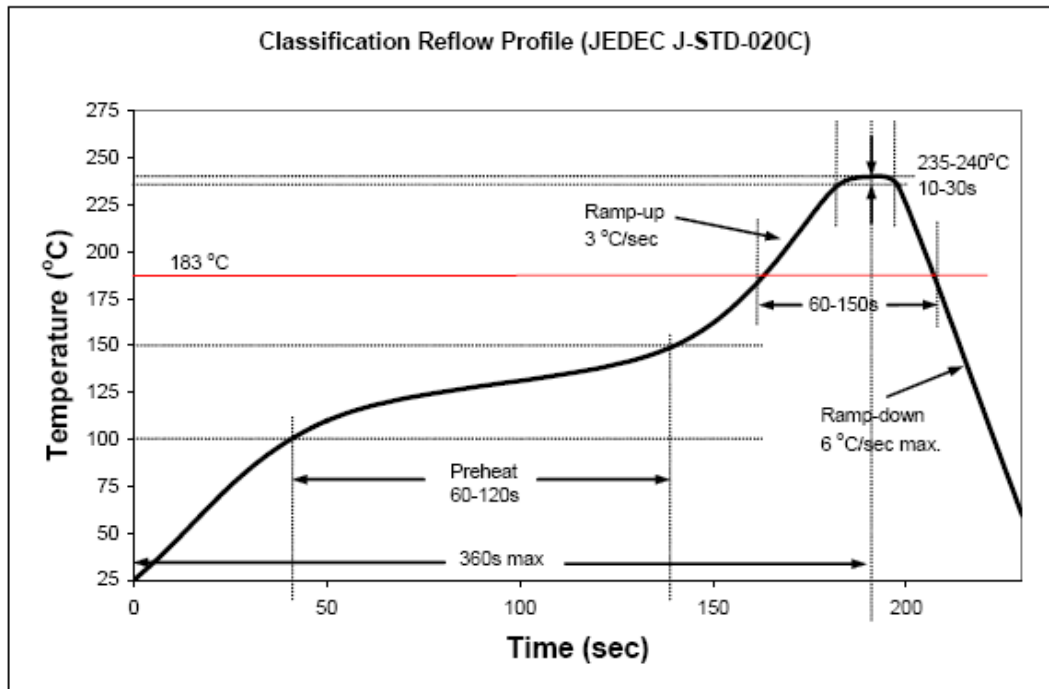

Recommended Pb Free IR-Reflow Soldering Profile.

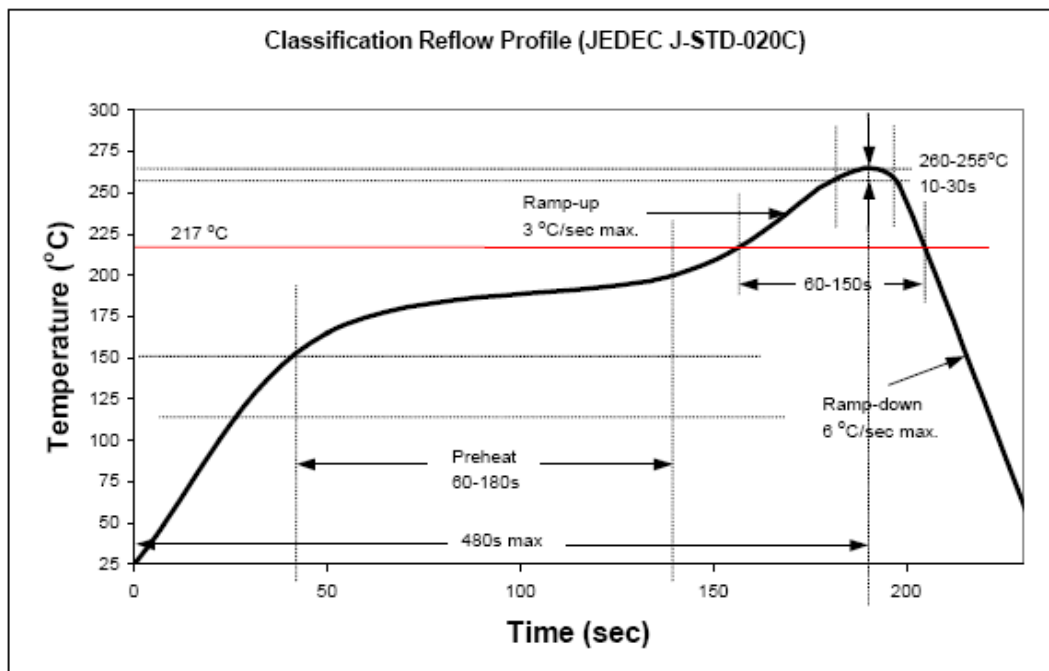

General Note

TT Electronics reserves the right to make changes in product specification without notice or liability. All information is subject to TT Electronics' own data and is considered accurate at time of going to print.

TT Electronics | OPTEK Technology
1645 Wallace Drive, Carrollton, TX 75006 | Ph: +1 972 323 2200
www.ttelectronics.com | www.optekinc.com

Mini Half-Watt SMD 3.5mm (120° Viewing Angle)



OVS5MxBCR4 Series

Reel Dimensions: 7-inch reel

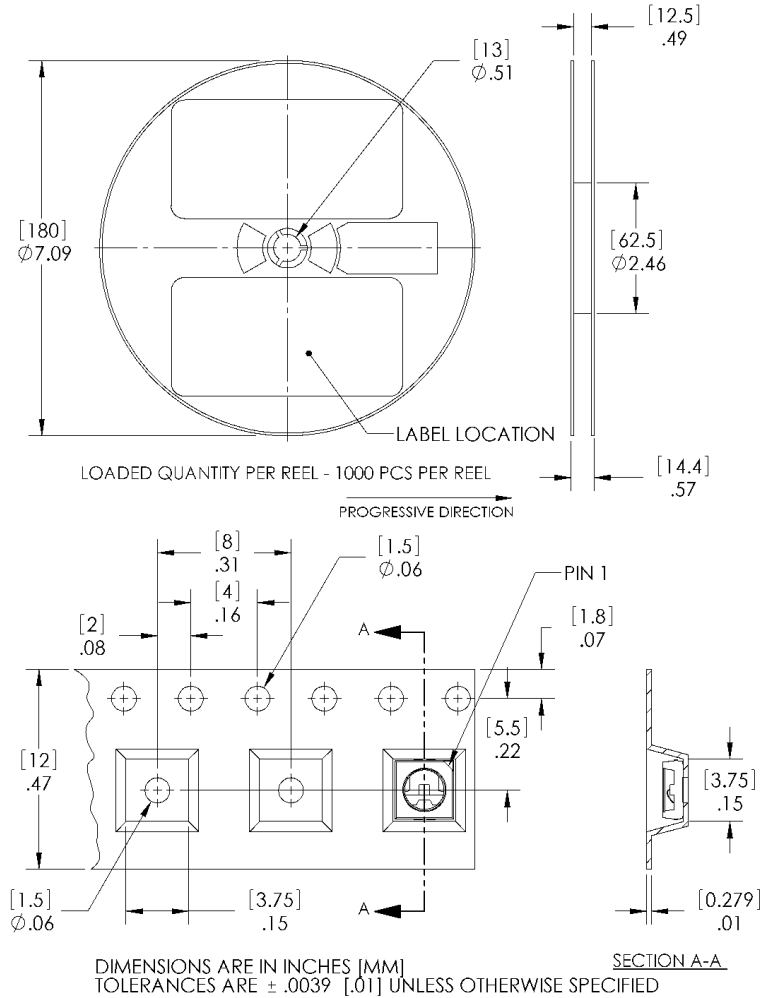

Carrier Tape Dimensions: Loaded quantity 1000 pieces per reel

Moisture Resistant Packaging

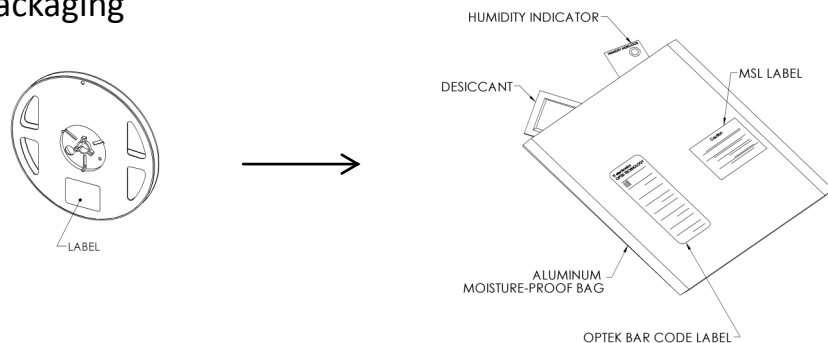

General Note

TT Electronics reserves the right to make changes in product specification without notice or liability. All information is subject to TT Electronics' own data and is considered accurate at time of going to print.

TT Electronics | OPTEK Technology
1645 Wallace Drive, Carrollton, TX 75006 | Ph: +1 972 323 2200
www.ttelectronics.com | www.optekinc.com

Данный компонент на территории Российской Федерации

Вы можете приобрести в компании MosChip.

Для оперативного оформления запроса Вам необходимо перейти по данной ссылке:

<http://moschip.ru/get-element>

Вы можете разместить у нас заказ для любого Вашего проекта, будь то серийное производство или разработка единичного прибора.

В нашем ассортименте представлены ведущие мировые производители активных и пассивных электронных компонентов.

Нашей специализацией является поставка электронной компонентной базы двойного назначения, продукции таких производителей как XILINX, Intel (ex.ALTERA), Vicor, Microchip, Texas Instruments, Analog Devices, Mini-Circuits, Amphenol, Glenair.

Сотрудничество с глобальными дистрибьюторами электронных компонентов, предоставляет возможность заказывать и получать с международных складов практически любой перечень компонентов в оптимальные для Вас сроки.

На всех этапах разработки и производства наши партнеры могут получить квалифицированную поддержку опытных инженеров.

Система менеджмента качества компании отвечает требованиям в соответствии с ГОСТ Р ИСО 9001, ГОСТ РВ 0015-002 и ЭС РД 009

Офис по работе с юридическими лицами:

105318, г.Москва, ул.Щербаковская д.3, офис 1107, 1118, ДЦ «Щербаковский»

Телефон: +7 495 668-12-70 (многоканальный)

Факс: +7 495 668-12-70 (доб.304)

E-mail: info@moschip.ru

Skype отдела продаж:

moschip.ru

moschip.ru_4

moschip.ru_6

moschip.ru_9