

EL8170, EL8173

Micropower, Single Supply, Rail-to-Rail Input-Output Instrumentation Amplifiers

FN7490
Rev 8.00
August 11, 2015

The EL8170 and EL8173 are micropower instrumentation amplifiers optimized for single supply operation over the +2.4V to +5.5V range. Inputs and outputs can operate rail-to-rail. As with all instrumentation amplifiers, a pair of inputs provide very high common-mode rejection and are completely independent from a pair of feedback terminals. The feedback terminals allow zero input to be translated to any output offset, including ground. A feedback divider controls the overall gain of the amplifier.

The EL8170 is compensated for a gain of 100 or more, and the EL8173 is compensated for a gain of 10 or more. The EL8170 and EL8173 have bipolar input devices for best offset and 1/f noise performance.

The amplifiers can be operated from one lithium cell or two Ni-Cd batteries. The EL8170 and EL8173 input range includes ground to slightly above positive rail. The output stage swings to ground and positive supply (no pull-up or pull-down resistors are needed).

Pin Configurations

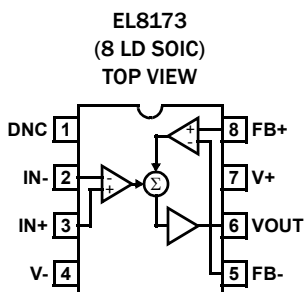
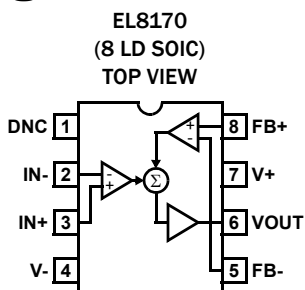

Features

- 95µA maximum supply current
- Maximum offset voltage
 - 200µV (EL8170)
 - 1000µV (EL8173)
- Maximum 3nA input bias current
- 396kHz -3dB bandwidth (G = 10)
- 192kHz -3dB bandwidth (G = 100)
- Single supply operation
 - Input voltage range is rail-to-rail
 - Output swings rail-to-rail
- Pb-Free (RoHS Compliant)

Applications

- Battery- or Solar-Powered Systems
- Strain Gauges
- Current Monitors
- Thermocouple Amplifiers

Ordering Information

PART NUMBER (Notes 2, 3)	PART MARKING	PACKAGE (RoHS Compliant)	PKG. DWG. #
EL8170FSZ (Note 1)	8170FSZ	8 Ld SOIC	M8.15E
EL8173FSZ (Note 1) (No longer available or supported)	8173FSZ	8 Ld SOIC	M8.15E
EL8170FWZ-EVAL	Evaluation Board		
EL8173EV1Z (No longer available or supported)	Evaluation Board		
EL8173FWZ-EVAL (No longer available or supported)	Evaluation Board		

NOTES:

1. Add "-T*" suffix for tape and reel. Please refer to [TB347](#) for details on reel specifications.
2. These Intersil Pb-free plastic packaged products employ special Pb-free material sets, molding compounds/die attach materials, and 100% matte tin plate plus anneal (e3 termination finish, which is RoHS compliant and compatible with both SnPb and Pb-free soldering operations). Intersil Pb-free products are MSL classified at Pb-free peak reflow temperatures that meet or exceed the Pb-free requirements of IPC/JEDEC J STD-020.
3. For Moisture Sensitivity Level (MSL), please see device information page for [EL8170](#), [EL8173](#) For more information on MSL, please see tech brief [TB363](#).

Absolute Maximum Ratings ($T_A = +25^\circ\text{C}$)

Supply Voltage Range, V_+	5.75V, 1V/ μs
Differential Input Current	5mA
Differential Input Voltage	
EL8170	0.5V
EL8173	1.0V
ESD Rating	
Human Body Model (EL8173)	2500V
Machine Model	250V

Thermal Information

Thermal Resistance (Typical)	θ_{JA} ($^\circ\text{C}/\text{W}$)
8 Ld SOIC Package (Note 4)	122
Output Short-Circuit Duration	Indefinite
Ambient Operating Temperature	-40°C to $+125^\circ\text{C}$
Storage Temperature	-65°C to $+150^\circ\text{C}$

Pb-Free Reflow Profile

see link below
<http://www.intersil.com/pbfree/Pb-FreeReflow.asp>

CAUTION: Do not operate at or near the maximum ratings listed for extended periods of time. Exposure to such conditions may adversely impact product reliability and result in failures not covered by warranty.

NOTE:

4. θ_{JA} is measured with the component mounted on a high effective thermal conductivity test board in free air. See Tech Brief [TB379](#) for details.

IMPORTANT NOTE: All parameters having Min/Max specifications are guaranteed. Typical values are for information purposes only. Unless otherwise noted, all tests are at the specified temperature and are pulsed tests, therefore: $T_J = T_C = T_A$

Electrical Specifications $V_+ = +5\text{V}$, $V_- = \text{GND}$, $\text{VCM} = 1/2V_+$, $R_L = \text{Open}$, $T_A = +25^\circ\text{C}$, unless otherwise specified. **Boldface limits apply over the operating temperature range, -40°C to $+125^\circ\text{C}$.**

PARAMETER	DESCRIPTION	CONDITIONS	MIN (Note 5)	TYP	MAX (Note 5)	UNIT
DC SPECIFICATIONS						
V_{OS}	Input Offset Voltage	EL8170	-200 -300	± 50	200 300	μV
		EL8173	-1000 -1500	± 200	1000 1500	μV
TCV_{OS}	Input Offset Voltage Temperature Coefficient	EL8170		0.24		$\mu\text{V}/^\circ\text{C}$
		EL8173		2.5		$\mu\text{V}/^\circ\text{C}$
I_{OS}	Input Offset Current between $\text{IN}+$, and $\text{IN}-$ and between $\text{FB}+$ and $\text{FB}-$		-2 -3	± 0.2	2 3	nA
I_B	Input Bias Current ($\text{IN}+$, $\text{IN}-$, $\text{FB}+$, and $\text{FB}-$ terminals)		-3 -4	± 0.7	3 4	nA
V_{IN}	Input Voltage Range	Guaranteed by CMRR test	0		5	V
CMRR	Common Mode Rejection Ratio	EL8170	90 85	114		dB
		EL8173	85 80	106		dB
PSRR	Power Supply Rejection Ratio	EL8170	85 80	106		dB
		EL8173	75 70	90		dB
E_G	Gain Error	EL8170	-1.5 2	+0.35	1.5 2	%
		EL8173	-0.4 -0.8	+0.1	0.4 0.8	%

Electrical Specifications $V_+ = +5V$, $V_- = GND$, $V_{CM} = 1/2V_+$, $R_L = \text{Open}$, $T_A = +25^\circ\text{C}$, unless otherwise specified. **Boldface limits apply over the operating temperature range, -40°C to $+125^\circ\text{C}$.** (Continued)

PARAMETER	DESCRIPTION	CONDITIONS	MIN (Note 5)	TYP	MAX (Note 5)	UNIT
V _{OUT}	Maximum Voltage Swing	Output low, $R_L = 100\text{k}\Omega$ to $+2.5V$		4	10	mV
		Output low, $R_L = 1\text{k}\Omega$ to $+2.5V$		0.13	0.2 0.25	V
		Output high, $R_L = 100\text{k}\Omega$ to $+2.5V$	4.985 4.980	4.996		V
		Output high, $R_L = 1\text{k}\Omega$ to $+2.5V$	4.75	4.887		V
I _S	Supply Current		45 38	65	95 110	μA
V _{SUPPLY}	Supply Operating Range	V_+ to V_-	2.4		5.5	V
I _{O+}	Output Source Current into 10Ω to $V_+/2$	$V_+ = +5V$	23 19	32		mA
		$V_+ = +2.4V$	6 4.5	8		mA
I _{O-}	Output Sink Current into 10Ω to $V_+/2$	$V_+ = +5V$	19 15	26		mA
		$V_+ = +2.4V$	5 4	7		mA
AC SPECIFICATIONS						
-3dB BW	-3dB Bandwidth	EL8170	Gain = 100		192	kHz
			Gain = 200		93	kHz
			Gain = 500		30	kHz
			Gain = 1000		13	kHz
		EL8173	Gain = 10		396	kHz
			Gain = 20		221	kHz
			Gain = 50		69	kHz
			Gain = 100		30	kHz
e _N	Input Noise Voltage	EL8170	$f = 0.1\text{Hz}$ to 10Hz		3.5	μV_{P-P}
		EL8173			3.6	μV_{P-P}
	Input Noise Voltage Density	EL8170	$f_o = 1\text{kHz}$		58	$\text{nV}/\sqrt{\text{Hz}}$
		EL8173			220	$\text{nV}/\sqrt{\text{Hz}}$
i _N	Input Noise Current Density	EL8170	$f_o = 1\text{kHz}$		0.38	$\text{pA}/\sqrt{\text{Hz}}$
		EL8173	$f_o = 1\text{kHz}$		0.8	$\text{pA}/\sqrt{\text{Hz}}$
CMRR @ 60Hz	Input Common Mode Rejection Ratio	EL8170	$V_{CM} = 1V_{P-P}$ $R_L = 10\text{k}\Omega$ to V_{CM}		100	dB
		EL8173			84	dB
PSRR+ @ 120Hz	Power Supply Rejection Ratio (V_+)	EL8170	$V_+, V_- = \pm 2.5V$, $V_{SOURCE} = 1V_{P-P}$ $R_L = 10\text{k}\Omega$ to V_{CM}		98	dB
		EL8173			78	dB
PSRR- @ 120Hz	Power Supply Rejection Ratio (V_-)	EL8170	$V_+, V_- = \pm 2.5V$, $V_{SOURCE} = 1V_{P-P}$ $R_L = 10\text{k}\Omega$ to V_{CM}		106	dB
		EL8173			82	dB
TRANSIENT RESPONSE						
SR	Slew Rate	$R_L = 1\text{k}\Omega$ to GND	0.4 0.35	0.55	0.7 0.7	V/ μs

NOTE:

5. Parameters with MIN and/or MAX limits are 100% tested at $+25^\circ\text{C}$, unless otherwise specified. Temperature limits established by characterization and are not production tested.

Typical Performance Curves $v_+ = +5V, v_- = 0V, v_{CM} = +2.5V, R_L = \text{Open}$, unless otherwise specified.

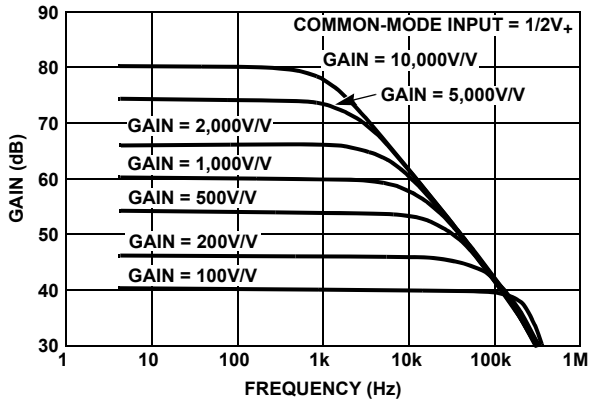

FIGURE 1. EL8170 FREQUENCY RESPONSE vs CLOSED LOOP GAIN

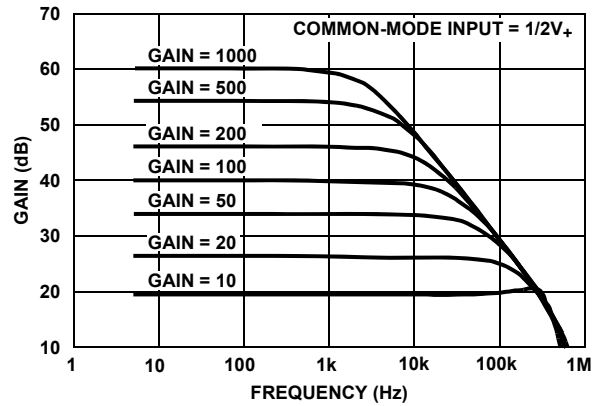

FIGURE 2. EL8173 FREQUENCY RESPONSE vs CLOSED LOOP GAIN

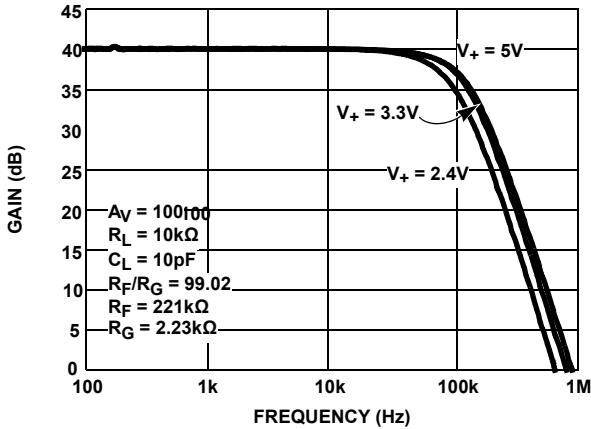

FIGURE 3. EL8170 FREQUENCY RESPONSE vs SUPPLY VOLTAGE

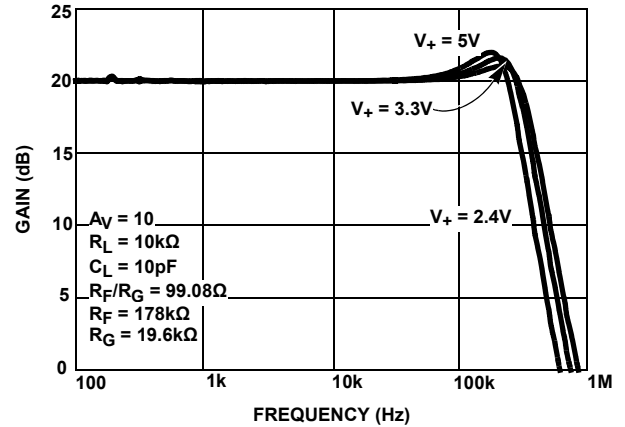

FIGURE 4. EL8173 FREQUENCY RESPONSE vs SUPPLY VOLTAGE

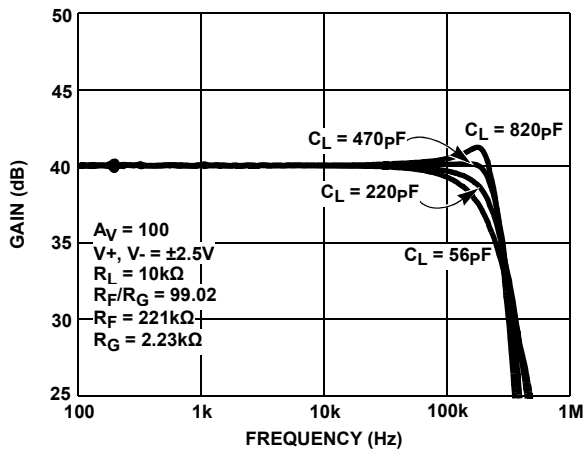

FIGURE 5. EL8170 FREQUENCY RESPONSE vs C_{LOAD}

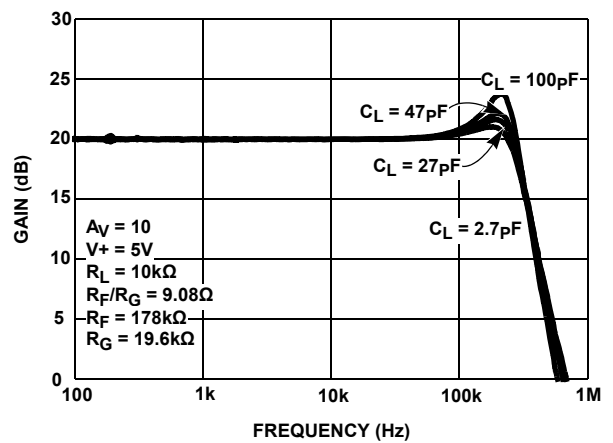

FIGURE 6. EL8173 FREQUENCY RESPONSE vs C_{LOAD}

Typical Performance Curves $v_+ = +5V$, $v_- = 0V$, $v_{CM} = +2.5V$, $R_L = \text{Open}$, unless otherwise specified. **(Continued)**

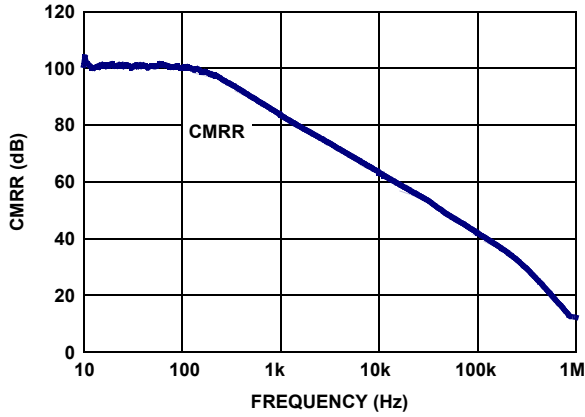

FIGURE 7. EL8170 CMRR vs FREQUENCY

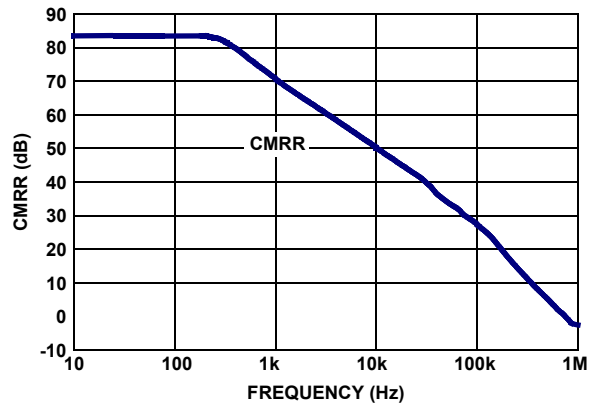

FIGURE 8. EL8173 CMRR vs FREQUENCY

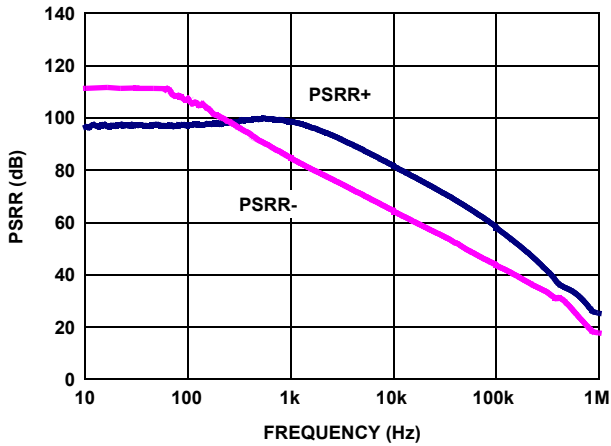

FIGURE 9. EL8170 PSRR vs FREQUENCY

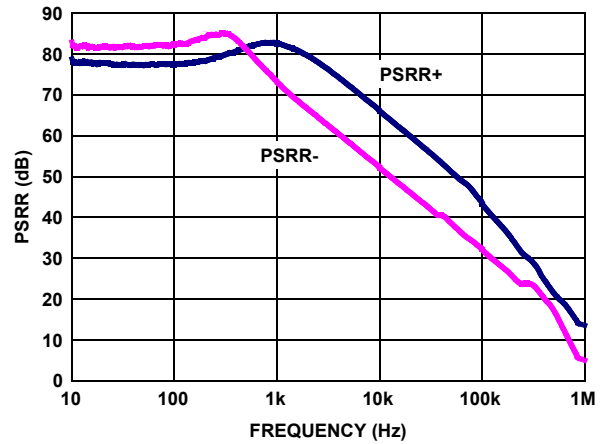

FIGURE 10. EL8173 PSRR vs FREQUENCY

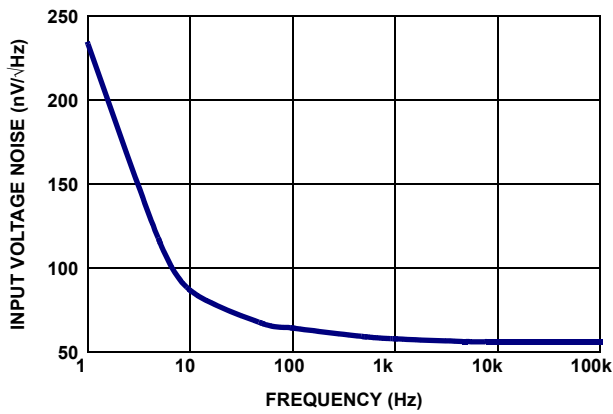

FIGURE 11. EL8170 VOLTAGE NOISE DENSITY

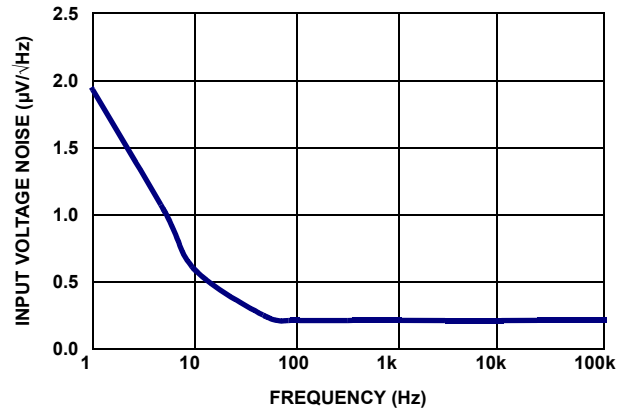

FIGURE 12. EL8173 VOLTAGE NOISE DENSITY

Typical Performance Curves $v_+ = +5V$, $v_- = 0V$, $v_{CM} = +2.5V$, $R_L = \text{Open}$, unless otherwise specified. **(Continued)**

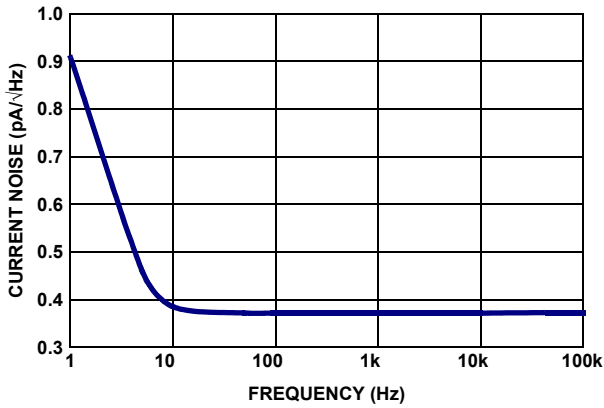

FIGURE 13. EL8170 CURRENT NOISE DENSITY

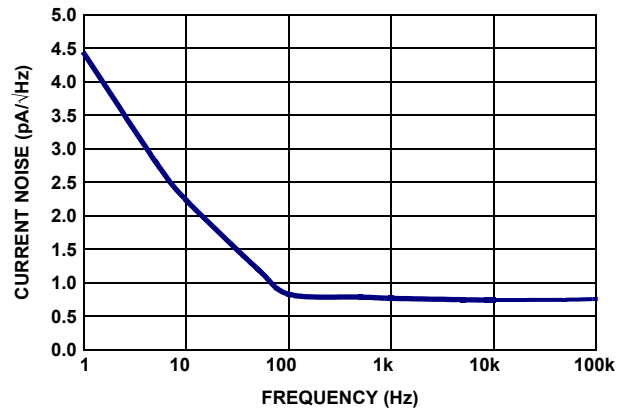

FIGURE 14. EL8173 CURRENT NOISE DENSITY

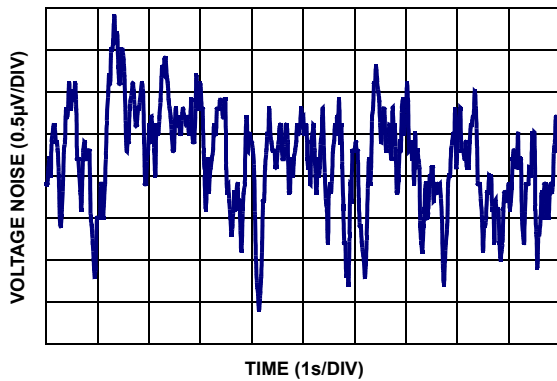

FIGURE 15. EL8170 0.1Hz TO 10Hz INPUT VOLTAGE NOISE (GAIN = 100)

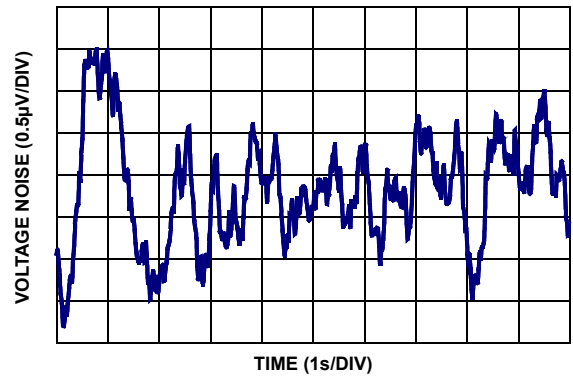

FIGURE 16. EL8173 0.1Hz TO 10Hz INPUT VOLTAGE NOISE (GAIN = 10)

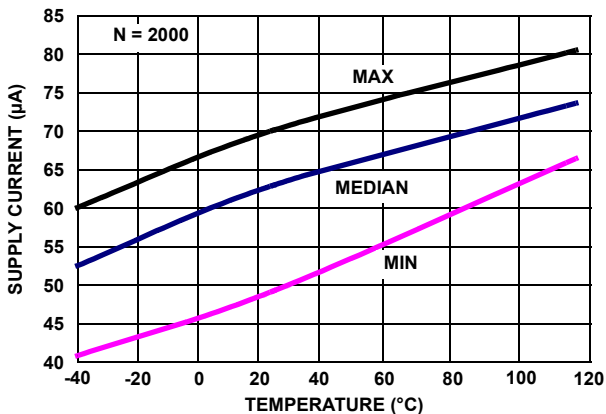

FIGURE 17. EL8170 SUPPLY CURRENT vs TEMPERATURE, $v_+, v_- = \pm 2.5V$, $v_{IN} = 0V$

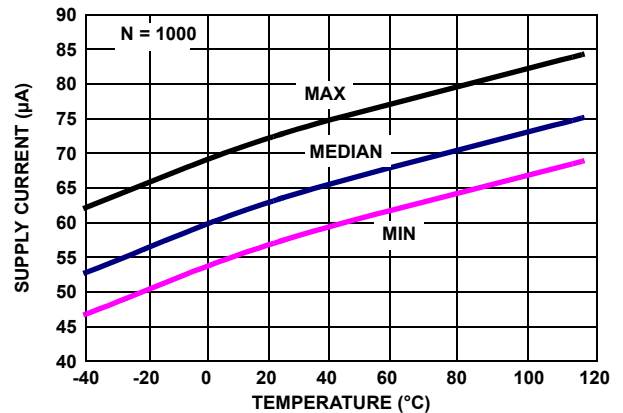

FIGURE 18. EL8173 SUPPLY CURRENT vs TEMPERATURE, $v_+, v_- = \pm 2.5V$, $v_{IN} = 0V$

Typical Performance Curves $v_+ = +5V$, $v_- = 0V$, $V_{CM} = +2.5V$, $R_L = \text{Open}$, unless otherwise specified. **(Continued)**

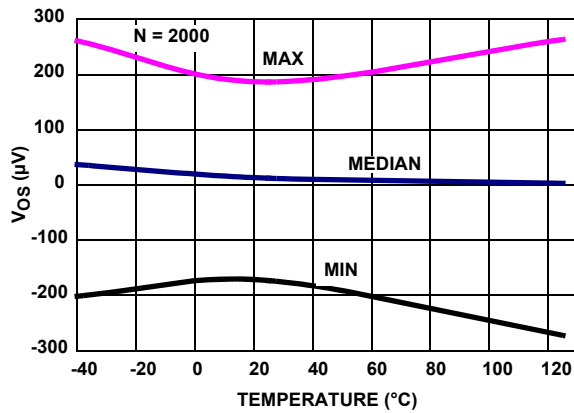

FIGURE 19. EL8170 V_{OS} vs TEMPERATURE, V_+ , $V_- = \pm 2.5V$, $V_{IN} = 0V$

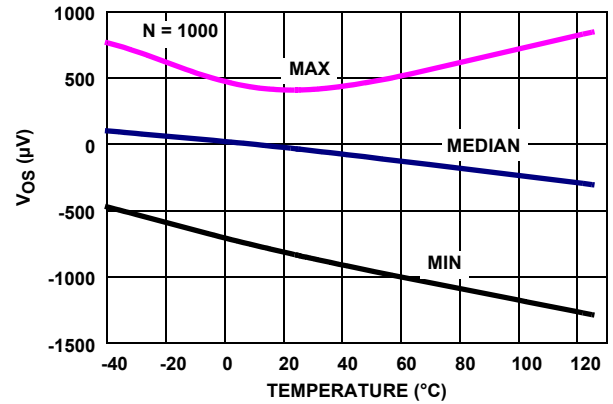

FIGURE 20. EL8173 V_{OS} vs TEMPERATURE, V_+ , $V_- = \pm 2.5V$, $V_{IN} = 0V$

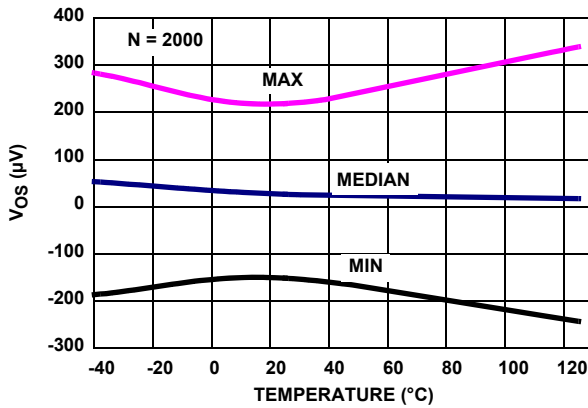

FIGURE 21. EL8170 V_{OS} vs TEMPERATURE, V_+ , $V_- = \pm 1.2V$, $V_{IN} = 0V$

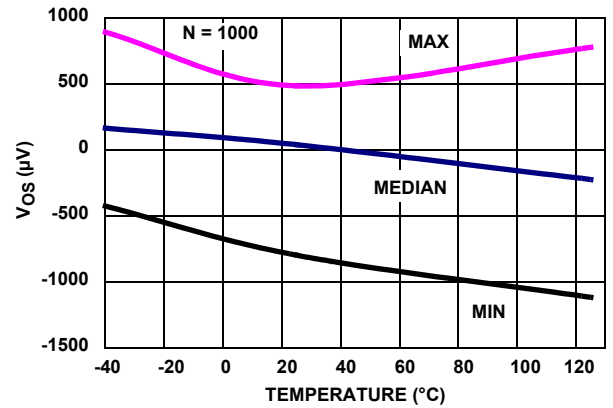

FIGURE 22. EL8173 V_{OS} vs TEMPERATURE, V_+ , $V_- = \pm 1.2V$, $V_{IN} = 0V$

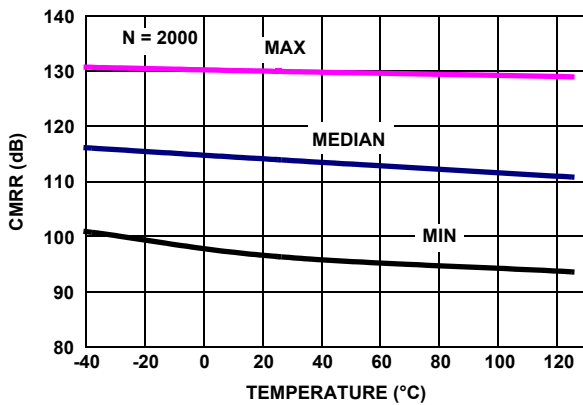

FIGURE 23. EL8170 CMRR vs TEMPERATURE, $V_{CM} = +2.5V$ TO $-2.5V$, V_+ , $V_- = \pm 2.5V$

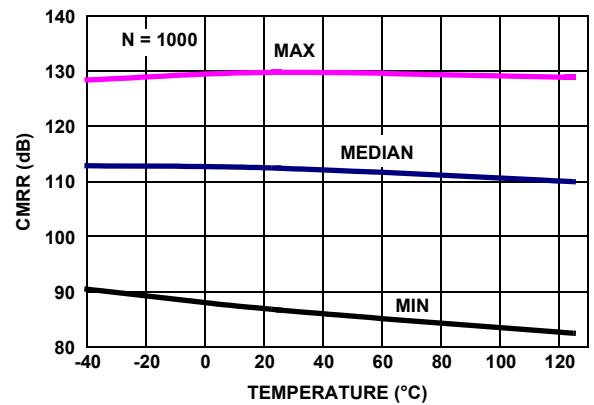

FIGURE 24. EL8173 CMRR vs TEMPERATURE, $V_{CM} = +2.5V$ TO $-2.5V$, V_+ , $V_- = \pm 2.5V$

Typical Performance Curves $V_+ = +5V$, $V_- = 0V$, $V_{CM} = +2.5V$, $R_L = \text{Open}$, unless otherwise specified. **(Continued)**

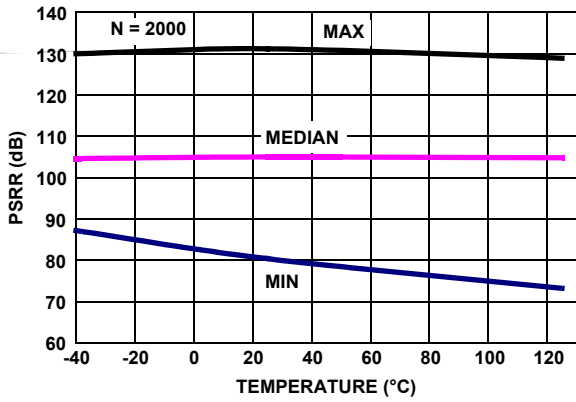

FIGURE 25. EL8170 PSRR vs TEMPERATURE, $V_+, V_- = \pm 1.2V$ TO $\pm 2.5V$

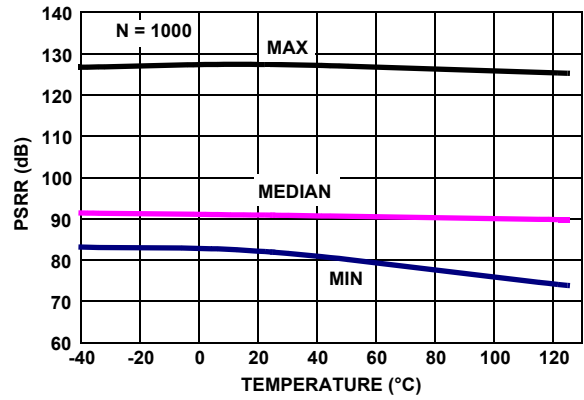

FIGURE 26. EL8173 PSRR vs TEMPERATURE, $V_+, V_- = \pm 1.2V$ TO $\pm 2.5V$

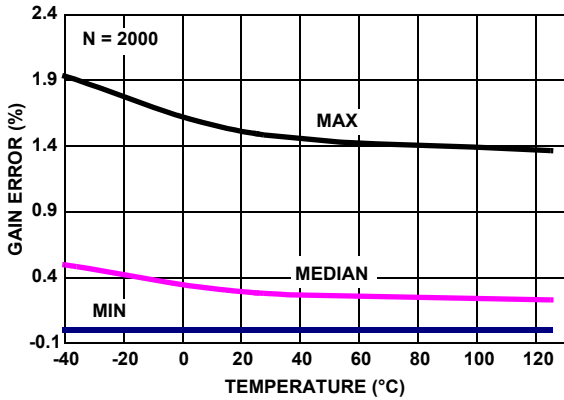

FIGURE 27. EL8170 %GAIN ERROR vs TEMPERATURE, $R_L = 100k$

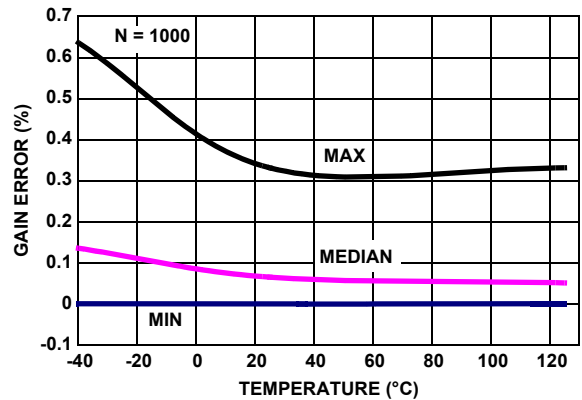

FIGURE 28. EL8173 %GAIN ERROR vs TEMPERATURE, $R_L = 100k$

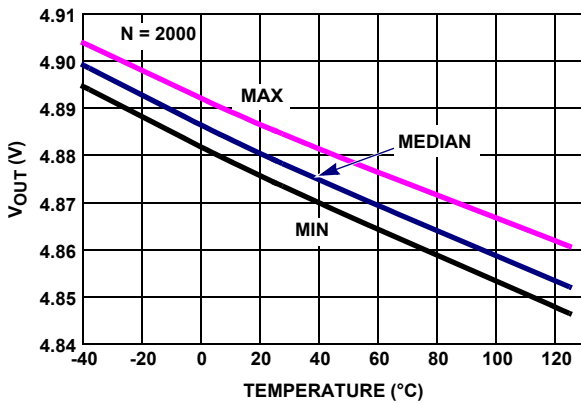

FIGURE 29. EL8170 V_{OUT} HIGH vs TEMPERATURE, $R_L = 1k$, $V_+, V_- = \pm 2.5V$

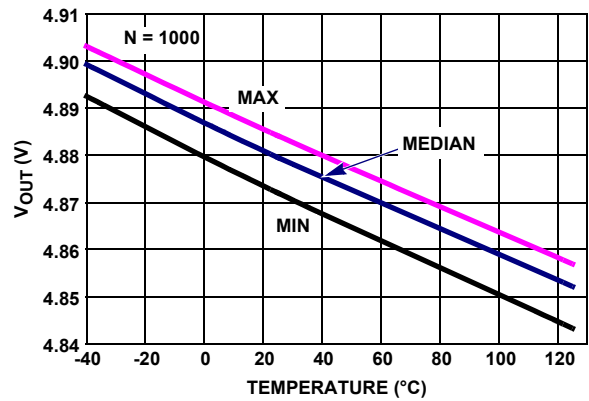

FIGURE 30. EL8173 V_{OUT} HIGH vs TEMPERATURE, $R_L = 1k$, $V_+, V_- = \pm 2.5V$

Typical Performance Curves $v_+ = +5V, v_- = 0V, v_{CM} = +2.5V, R_L = \text{Open}$, unless otherwise specified. **(Continued)**

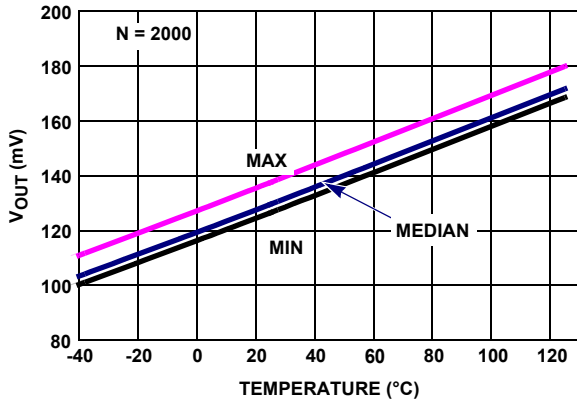

FIGURE 31. EL8170 V_{OUT} LOW vs TEMPERATURE, $R_L = 1k, v_+ = \pm 2.5V, v_- = \pm 2.5V$

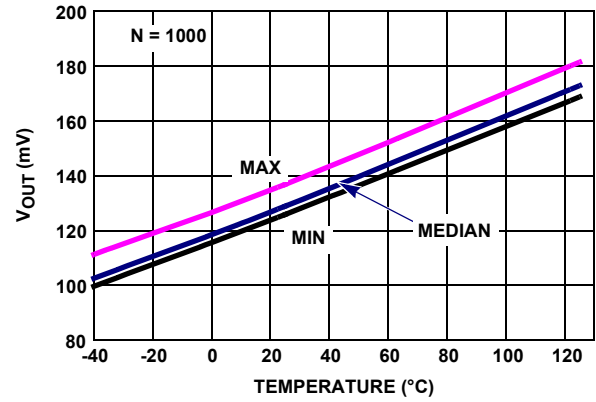

FIGURE 32. EL8173 V_{OUT} LOW vs TEMPERATURE, $R_L = 1k, v_+ = \pm 2.5V, v_- = \pm 2.5V$

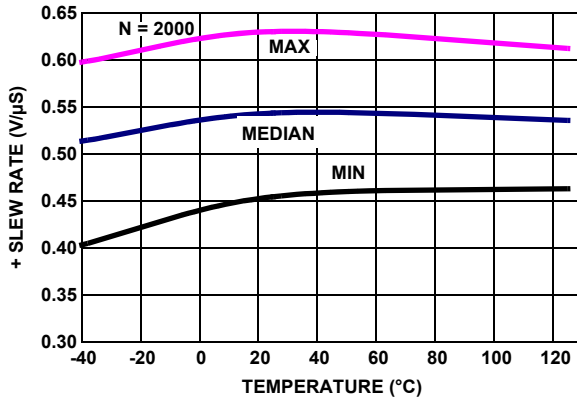

FIGURE 33. EL8170 + SLEW RATE vs TEMPERATURE, INPUT $\pm 0.015V$ @ GAIN + 100

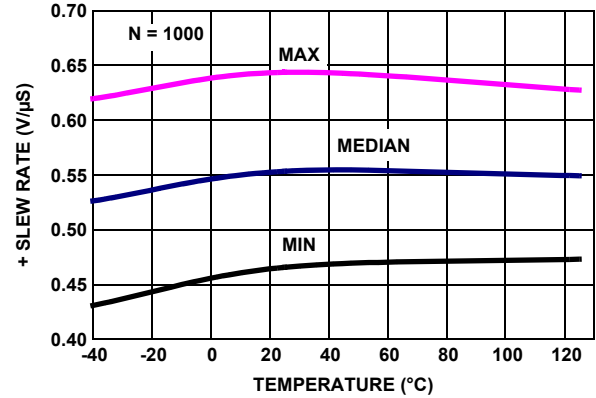

FIGURE 34. EL8173 + SLEW RATE vs TEMPERATURE, INPUT $\pm 0.015V$ @ GAIN + 100

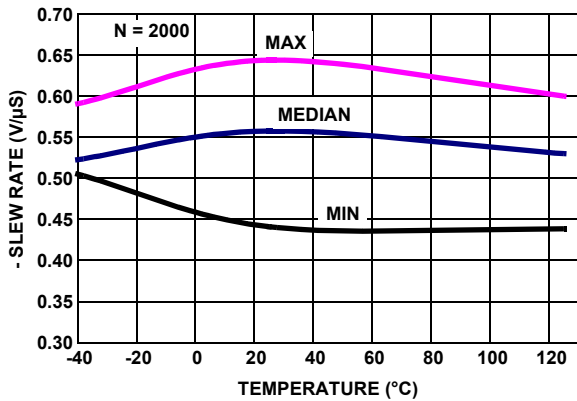

FIGURE 35. EL8170 - SLEW RATE vs TEMPERATURE, INPUT $\pm 0.015V$ @ GAIN + 100

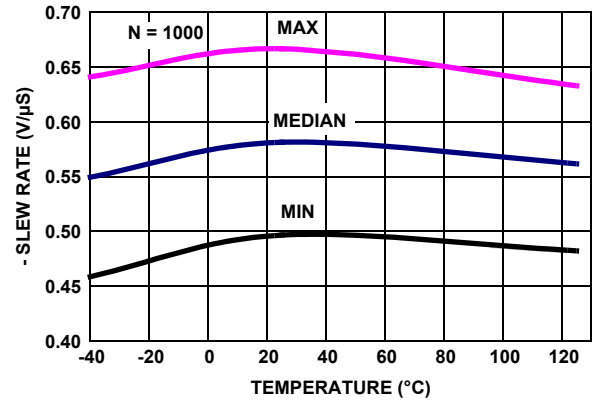
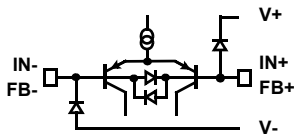

FIGURE 36. EL8173 - SLEW RATE vs TEMPERATURE, INPUT $\pm 0.015V$ @ GAIN + 100

Pin Descriptions

EL8170	EL8173	PIN NAME	EQUIVALENT CIRCUIT	PIN FUNCTION
1	1	DNC		Do Not Connect; Internal connection - Must be left floating.
2	2	IN-	Circuit 1A, Circuit 1B	High impedance input terminals. The EL8170 input circuit is shown in Circuit 1A, and the EL8173 input circuit is shown in Circuit 1B. The EL8173: to avoid offset drift, it is recommended that the terminals are not overdriven beyond 1V and the input current must never exceed 5mA.
3	3	IN+	Circuit 1A, Circuit 1B	
4	4	V-	Circuit 3	Negative supply terminal.
5	5	FB-	Circuit 1A, Circuit 1B	High impedance feedback terminals. The EL8170 input circuit is shown in Circuit 1A, and the EL8173 input circuit is shown in Circuit 1B. The EL8173: to avoid offset drift, it is recommended that the terminals are not overdriven beyond 1V and the input current must never exceed 5mA.
8	8	FB+	Circuit 1A, Circuit 1B	
7	7	V+	Circuit 3	Positive supply terminal.
6	6	VOUT	Circuit 2	Output voltage.



CIRCUIT 1A

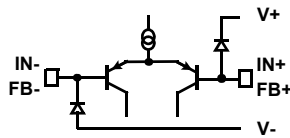

CIRCUIT 1B

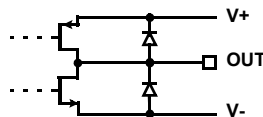

CIRCUIT 2

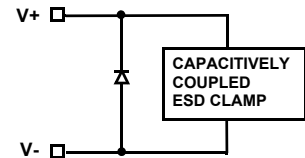

CIRCUIT 3

Description of Operation and Applications Information

Product Description

The EL8170 and EL8173 are micropower instrumentation amplifiers (in-amps) which deliver rail-to-rail input amplification and rail-to-rail output swing on a single +2.4V to +5.5V supply. The EL8170 and EL8173 also deliver excellent DC and AC specifications while consuming only 65µA typical supply current. The EL8170 and EL8173 provides an independent pairs of feedback terminals to set the gain and to adjust output level, these in-amps achieve high common-mode rejection ratio regardless of the tolerance of the gain setting resistors. The EL8173 is internally compensated for a minimum closed loop gain of 10 or greater, well suited for moderate to high gains. For higher gains, the EL8170 is internally compensated for a minimum gain of 100.

Input Protection

All input and feedback terminals of the EL8170 and EL8173 have internal ESD protection diodes to both positive and negative supply rails, limiting the input voltage to within one diode drop beyond the supply rails. The inverting inputs and FB- have ESD diodes to the V-rail, and the non-inverting inputs and FB+ terminals have ESD diodes to the V+ rail. The EL8170 has

additional back-to-back diodes across the input terminals and also across the feedback terminals. If overdriving the inputs is necessary, the external input current must never exceed 5mA. On the other hand, the EL8173 has no clamps to limit the differential voltage on the input terminals allowing higher differential input voltages at lower gain applications. It is recommended however, that the input terminals of the EL8173 are not overdriven beyond 1V to avoid offset drift. An external series resistor may be used as an external protection to limit excessive external voltage and current from damaging the inputs.

Input Stage and Input Voltage Range

The input terminals (IN+ and IN-) of the EL8170 and EL8173 are single differential pair bipolar PNP devices aided by an Input Range Enhancement Circuit to increase the headroom of operation of the common-mode input voltage. The feedback terminals (FB+ and FB-) also have a similar topology. As a result, the input common-mode voltage range of both the EL8170 and EL8173 is rail-to-rail. These in-amps are able to handle the input voltages that are at or slightly beyond the supply and ground making these in-amps well suited for single +5V or +3.3V low voltage supply systems. There is no need to move the common-mode input of the in-amps to achieve symmetrical input voltage.

Input Bias Cancellation, Input Bias Compensation

The EL8170 and EL8173 are features an Input Bias Cancellation and Input Bias Compensation Circuit for both the input and feedback terminals (IN+, IN-, FB+ and FB-), achieving a low input bias current all throughout the input common-mode range and the operating temperature range. While the PNP bipolar input stages are biased with an adequate amount of biasing current for speed and increased noise performance, the Input Bias Cancellation and the Input Bias Compensation Circuit, sinks most of the base current of the input transistor leaving a small portion as input bias current, typically 500pA. In addition, the Input Bias Cancellation and Input Bias Compensation Circuit, maintains a smooth and flat behavior of the input bias current over the common mode range and over the operating temperature range. The Input Bias Cancellation and Input Bias Compensation Circuit, operates from the input voltages of 10mV above the negative supply to the input voltages slightly above the positive supply. See “Average Input Bias Current vs Common-Mode Input Voltage” in the “Typical Performance Curves” beginning on page 4.

Output Stage and Output Voltage Range

A pair of complementary MOSFET devices drives the output V_{OUT} to within a few millivolts of the supply rails. At a 100kΩ load, the PMOS sources current and pulls the output up to 4mV below the positive supply, while the NMOS sinks current and pulls the output down to 4mV above the negative supply, or ground in the case of a single supply operation. The current sinking and sourcing capability of the EL8170 and EL8173 are internally limited to 26mA.

Gain Setting

V_{IN} , the potential difference across IN+ and IN-, is replicated (less the input offset voltage) across FB+ and FB-. The objective of the EL8170 and EL8173 in-amp is to maintain the differential voltage across FB+ and FB- equal to IN+ and IN-; $(FB+ - FB-) = (IN+ - IN-)$. Consequently, the transfer function can be derived. The gain of the EL8170 and EL8173 is set by two external resistors, the feedback resistor R_F , and the gain resistor R_G .

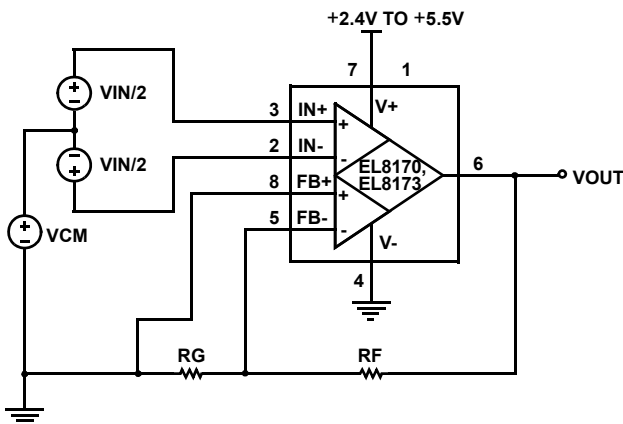

FIGURE 37. GAIN IS SET BY TWO EXTERNAL RESISTORS, R_F AND R_G

$$V_{OUT} = \left(1 + \frac{R_F}{R_G}\right) V_{IN} \tag{EQ. 1}$$

In Figure 37, the FB+ pin and one end of resistor R_G are connected to GND. With this configuration, Equation 1 is only true for a positive swing in V_{IN} ; negative input swings will be ignored and the output will be at ground.

Reference Connection

Unlike a three op amp instrumentation amplifier, a finite series resistance seen at the REF terminal does not degrade the EL8170 and EL8173's high CMRR performance, eliminating the need for an additional external buffer amplifier. The circuit shown in Figure 38 uses the FB+ pin as a REF terminal to center or to adjust the output. Because the FB+ pin is a high impedance input, an economical resistor divider can be used to set the voltage at the REF terminal. The reference voltage error due to the input bias current is minimized by keeping the values of the voltage divider resistors, R_1 and R_2 , as low as possible. Any voltage applied to the REF terminal will shift V_{OUT} by V_{REF} times the closed loop gain, which is set by resistors R_F and R_G according to Equation 2. Note that any noise or unwanted signals on the reference supply will be amplified at the output according to Equation 2.

$$V_{OUT} = \left(1 + \frac{R_F}{R_G}\right) (V_{IN}) + \left(1 + \frac{R_F}{R_G}\right) (V_{REF}) \tag{EQ. 2}$$

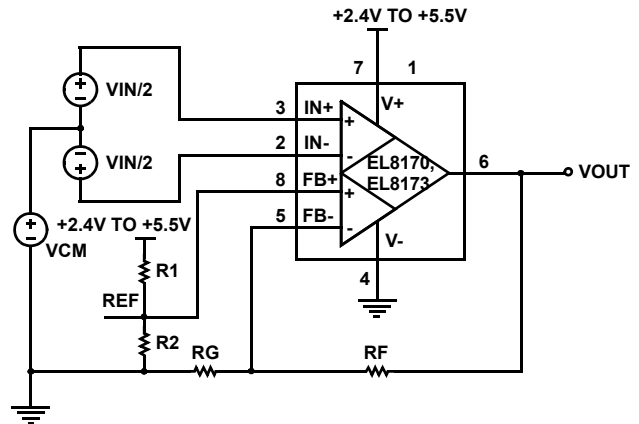

FIGURE 38. GAIN SETTING AND REFERENCE CONNECTION

The FB+ pin can also be connected to the other end of resistor, R_G (see Figure 39). Keeping the basic concept that the EL8170 and EL8173 in-amps maintain constant differential voltage across the input terminals and feedback terminals $(IN+ - IN- = FB+ - FB-)$, the transfer function of Figure 39 can be derived (Equation 3). Note that the V_{REF} gain term is eliminated, and susceptibility to external noise is reduced.

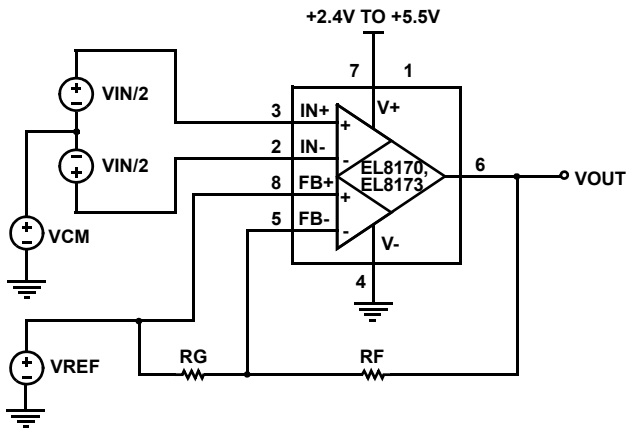

FIGURE 39. REFERENCE CONNECTION WITH AN AVAILABLE VREF

$$V_{OUT} = \left(1 + \frac{R_F}{R_G}\right)(V_{IN}) + (V_{REF}) \quad (EQ. 3)$$

External Resistor Mismatches

Because of the independent pair of feedback terminals provided by the EL8170 and EL8173, the CMRR is not degraded by any resistor mismatches. Hence, unlike a three op amp and especially a two op amp in-amp, the EL8170 and EL8173 reduce the cost of external components by allowing the use of 1% or more tolerance resistors without sacrificing CMRR performance. The EL8170 and EL8173 CMRR is maintained regardless of the tolerance of the resistors used.

Gain Error and Accuracy

The EL8173 has a Gain Error, E_G , of 0.2% typical. The EL8170 has an E_G of 0.3% typical. The gain error indicated in the "Electrical Specifications" table on page 2 is the inherent gain error of the EL8170 and EL8173 and does not include the gain error contributed by the resistors. There is an additional gain error due to the tolerance of the resistors used. The resulting non-ideal transfer function effectively becomes Equation 4:

$$V_{OUT} = \left(1 + \frac{R_F}{R_G}\right) \times [1 - (E_{RG} + E_{RF} + E_G)] \times V_{IN} \quad (EQ. 4)$$

Where:

E_{RG} = Tolerance of R_G

E_{RF} = Tolerance of R_F

E_G = Gain Error of the EL8170 or EL8173

The term $[1 - (E_{RG} + E_{RF} + E_G)]$ is the deviation from the theoretical gain. Thus, $(E_{RG} + E_{RF} + E_G)$ is the total gain error. For example, if 1% resistors are used for the EL8170, the total gain error would be as shown in Equation 5:

$$\begin{aligned} &= \pm(E_{RG} + E_{RF} + E_G(\text{typical})) \\ &= \pm(0.01 + 0.01 + 0.003) \\ &= \pm 2.3\% \end{aligned} \quad (EQ. 5)$$

Power Dissipation

It is possible to exceed the +150°C maximum junction temperatures under certain load and power-supply conditions. It is therefore important to calculate the maximum junction temperature (T_{JMAX}) for all applications to determine if power supply voltages, load conditions, or package type need to be modified to remain in the safe operating area. These parameters are related in Equation 6:

$$T_{JMAX} = T_{MAX} + (\theta_{JA} \times PD_{MAXTOTAL}) \quad (EQ. 6)$$

where:

- $PD_{MAXTOTAL}$ is the sum of the maximum power dissipation of each amplifier in the package (PD_{MAX})
- PD_{MAX} for each amplifier can be calculated as shown in Equation 7:

$$PD_{MAX} = 2 \times V_S \times I_{SMAX} + (V_S - V_{OUTMAX}) \times \frac{V_{OUTMAX}}{R_L} \quad (EQ. 7)$$

where:

- T_{MAX} = Maximum ambient temperature
- θ_{JA} = Thermal resistance of the package
- PD_{MAX} = Maximum power dissipation of 1 amplifier
- V_S = Supply voltage (Magnitude of V_+ and V_-)
- I_{MAX} = Maximum supply current of 1 amplifier
- V_{OUTMAX} = Maximum output voltage swing of the application
- R_L = Load resistance

Revision History

The revision history provided is for informational purposes only and is believed to be accurate, but not warranted. Please go to the web to make sure that you have the latest revision.

DATE	REVISION	CHANGE
August 11, 2015	FN7490.8	Added Revision History beginning with Rev 8. Added About Intersil Verbiage. Updated Ordering Information on page 1.

About Intersil

Intersil Corporation is a leading provider of innovative power management and precision analog solutions. The company's products address some of the largest markets within the industrial and infrastructure, mobile computing and high-end consumer markets.

For the most updated datasheet, application notes, related documentation and related parts, please see the respective product information page found at www.intersil.com.

You may report errors or suggestions for improving this datasheet by visiting www.intersil.com/ask.

Reliability reports are also available from our website at www.intersil.com/support

© Copyright Intersil Americas LLC 2009-2015. All Rights Reserved.
All trademarks and registered trademarks are the property of their respective owners.

For additional products, see www.intersil.com/en/products.html

Intersil products are manufactured, assembled and tested utilizing ISO9001 quality systems as noted in the quality certifications found at www.intersil.com/en/support/qualandreliability.html

Intersil products are sold by description only. Intersil may modify the circuit design and/or specifications of products at any time without notice, provided that such modification does not, in Intersil's sole judgment, affect the form, fit or function of the product. Accordingly, the reader is cautioned to verify that datasheets are current before placing orders. Information furnished by Intersil is believed to be accurate and reliable. However, no responsibility is assumed by Intersil or its subsidiaries for its use; nor for any infringements of patents or other rights of third parties which may result from its use. No license is granted by implication or otherwise under any patent or patent rights of Intersil or its subsidiaries.

For information regarding Intersil Corporation and its products, see www.intersil.com

Package Outline Drawing

M8.15E

8 LEAD NARROW BODY SMALL OUTLINE PLASTIC PACKAGE

Rev 0, 08/09

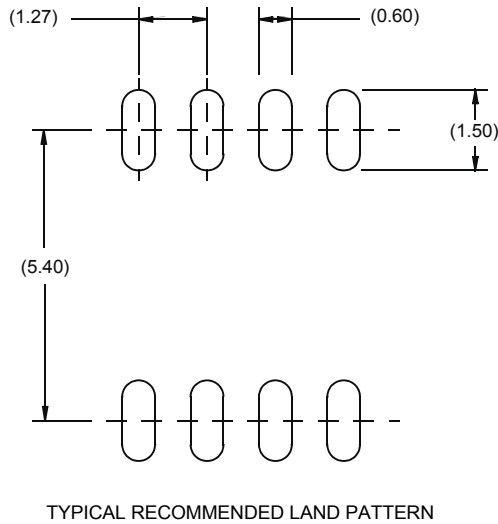
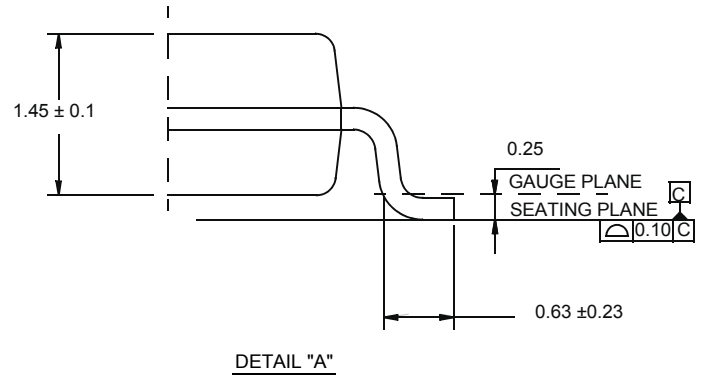
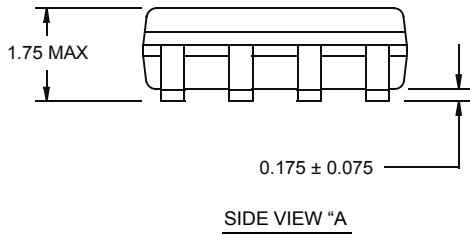
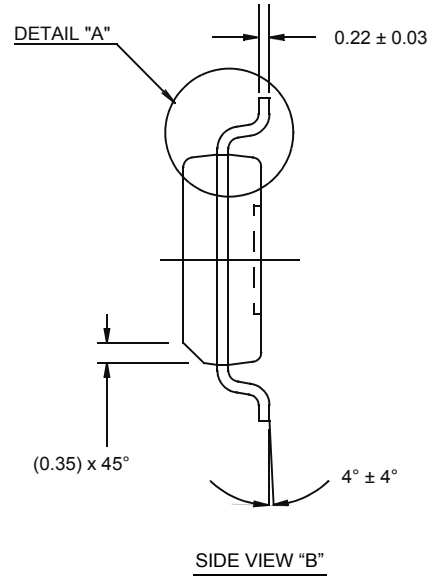
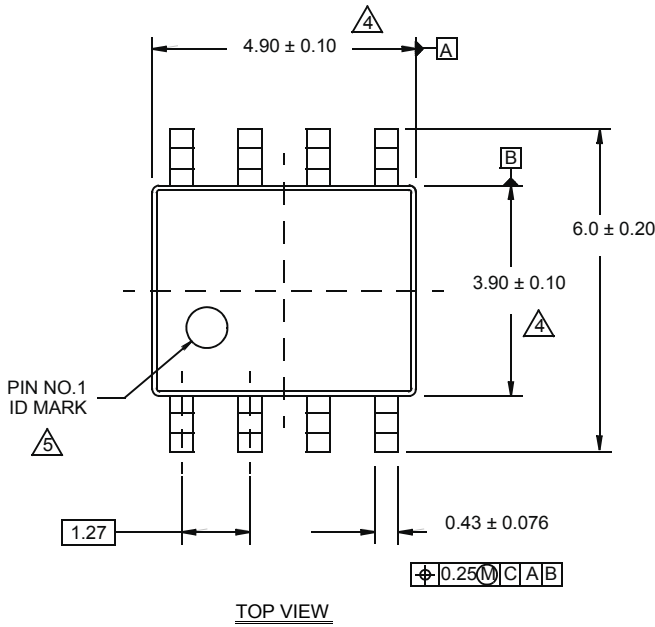

NOTES:

1. Dimensions are in millimeters.
Dimensions in () for Reference Only.
2. Dimensioning and tolerancing conform to AMSE Y14.5m-1994.
3. Unless otherwise specified, tolerance : Decimal ± 0.05
4. Dimension does not include interlead flash or protrusions.
Interlead flash or protrusions shall not exceed 0.25mm per side.
5. The pin #1 identifier may be either a mold or mark feature.
6. Reference to JEDEC MS-012.

Данный компонент на территории Российской Федерации

Вы можете приобрести в компании MosChip.

Для оперативного оформления запроса Вам необходимо перейти по данной ссылке:

<http://moschip.ru/get-element>

Вы можете разместить у нас заказ для любого Вашего проекта, будь то серийное производство или разработка единичного прибора.

В нашем ассортименте представлены ведущие мировые производители активных и пассивных электронных компонентов.

Нашей специализацией является поставка электронной компонентной базы двойного назначения, продукции таких производителей как XILINX, Intel (ex.ALTERA), Vicor, Microchip, Texas Instruments, Analog Devices, Mini-Circuits, Amphenol, Glenair.

Сотрудничество с глобальными дистрибьюторами электронных компонентов, предоставляет возможность заказывать и получать с международных складов практически любой перечень компонентов в оптимальные для Вас сроки.

На всех этапах разработки и производства наши партнеры могут получить квалифицированную поддержку опытных инженеров.

Система менеджмента качества компании отвечает требованиям в соответствии с ГОСТ Р ИСО 9001, ГОСТ РВ 0015-002 и ЭС РД 009

Офис по работе с юридическими лицами:

105318, г.Москва, ул.Щербаковская д.3, офис 1107, 1118, ДЦ «Щербаковский»

Телефон: +7 495 668-12-70 (многоканальный)

Факс: +7 495 668-12-70 (доб.304)

E-mail: info@moschip.ru

Skype отдела продаж:

moschip.ru

moschip.ru_4

moschip.ru_6

moschip.ru_9