



ETA-USA

HIGH QUALITY SWITCHING POWER SUPPLIES

AC/DC SWITCHING POWER SUPPLY
INPUT: 85~264VAC
SINGLE OUTPUT
10 WATTS

BWS/BWSE-SX-U SERIES

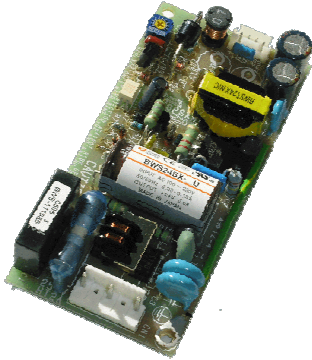

50Wx105Lx20H [mm]

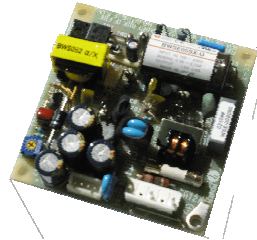

72.5Wx76Lx20.5H [mm]



General Description

BW-Series are open-board, low profile, low price switcher without chassis and cover. It is designed for small size and low cost applications worldwide. The output power can be boosted 15% to 30% above nominal.

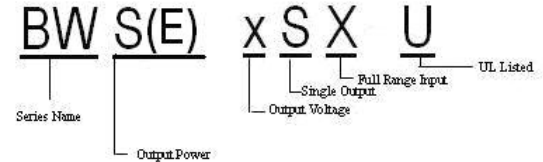

Options

- * Chassis +Cover (add suffix "-P")
 Example: BWS05SX-PU
 Dimension: 57x125x32 (mm)
- *40cm long wire harness

Features

1. Open Frame
2. Mountable on any axis
3. Input: 85~264Vac
4. Low cost
5. EMI: complies to EN55022B, FCC/B
6. Safety: UL 1950, (C-UL) EN60950
7. CE-marked acc. To LVD

Input Characteristics	Unit	BWS3.3SX-U	BWS05SX-U	BWS12SX-U	BWS15SX-U	BWS24SX-U
		BWSE3.3SX-U	BWSE05SX-U	BWSE12SX-U	BWSE15SX-U	BWSE24SX-U
Input Voltage	Vac	AC100-230V				
Input Voltage Range	Vdc	AC85-264V (DC110-370V)				
Input Current	A	0.3A at AC100V/0.15A at AC230V				
Input Frequency	Hz	50/60Hz				
Input Frequency Range	Hz	47-440Hz				
Inrush Current *1	A	15A (maximum) at AC100V/35A (maximum) at AC230V				
Phase		Single				
Efficiency (typical) *2	%	66	74	80	80	81

Output Characteristics	Unit	BWS3.3SX-U	BWS05SX-U	BWS12SX-U	BWS15SX-U	BWS24SX-U
		BWSE3.3SX-U	BWSE05SX-U	BWSE12SX-U	BWSE15SX-U	BWSE24SX-U
Output Voltage	Vdc	3.3	5	12	15	24
Output Current	A	2.0	2.0	0.9	0.7	0.5
Voltage Adjust Range	V	± 10% of Rated Output Voltage (at no load within the input range)				
Ripple and Noise(max.) *3	mV	83	100	170	200	290
Regulation						
a. Static Line Regulation max.	mV	26.4	40	96	120	192
b. Static Load Regulation max.	mV	29.7	45	108	135	216
c. Temperature Coefficient *4	%/°C	0.03%/°C				
d. Drift max. *5	mV	31.5	40	75	90	135
e. Dynamic Load Reg. typ.	mV	Not Specified				
f. Recovery Time	mS	Not Specified				
g. Rise Time	mS	200mS (maximum) at 25°C and rated input/output				
h. Hold Up Time	mS	20mS (typical) at 25°C and rated input/output				



ETA USA
 16170 Vineyard Blvd. Suite 180, Morgan Hill, CA 95037
 Phone: 1-800-ETA-POWR, (408) 778-2793 Fax: (408) 779-2753

Visit us at: www.eta-usa.com
 email at: sales@eta-usa.com



ETA-USA

HIGH QUALITY SWITCHING POWER SUPPLIES

Environmental Specification					
Operating Temperature	open board type:-5 to +50°C/enclosed type:-5 to +40°C				
Operating Humidity	20 to 85%RH(non-condensing)				
Storage Temperature	-20 to +85°C				
Storage Humidity	20 to 85%RH(non-condensing)				
Withstanding Voltage	Primary-Secondary AC3,000V for 1minute Primary-Frame Ground AC2,500V for 1minute Primary-Secondary-Frame Ground 100MΩ(minimum) by DC500V insulation tester				
Vibration	5-10Hz:10mm double amplitude,10-55Hz:19.6m/s ² ,20minutes' period for 60minutes each along X,Y,Z axes(non-operating)				
Shock	294m/s ²				
Cooling	Convection				
Isolation Resistance	Primary-Secondary-Frame Ground 1000MΩ(minimum) by DC500V insulation tester				
Function/Protection					
Over current Protection ≥110% of Rated Output Current[A] *6	Current Limiting with automatic recovery				
	2.2	2.2	0.99	0.77	0.55
Over voltage Protection ≥115% of Rated Output Voltage[V]	Zener diode clamping				
	3.8	5.75	13.8	17.3	27.6
Remote Sense	not available				
Remote On/Off	not available				
Other Specifications					
Leakage Current(typ.)	0.75mA(maximum) at 25°C ,rated input/output and rated input frequency				
Line Conducted Noise	Built to meet FCC Part15-B Class B Built to meet VCCI Class B Built to meet EN55022 Class B				
Safety	UL: UL1950 C-UL: CSA C22.2 No.950 VDE: EN60950, IEC950, VDE0805				
MTBF [H] *9	730,000				
Switching Frequency[kHz] (typ.) *7	80				
Mechanical Specification					
Dimension [mm]	BWS: 50Wx105Lx20H [mm] [1.969Wx4.134Lx0.7874H inch] BWSE: 72.5Wx76Lx20.5H [mm] [2.854Wx2.992Lx0.8071H inch]				
Weight (typical)	open board type:73g/enclosed type:160g				

Conditions:

- *1 at cold start
- *2 at DC130V input/rated output
- *3 measured by a bayonet probe at the end of a pair of 15cm long wires terminated with a 100uF electrolytic capacitor and 0.1uF film capacitor in parallel at a 0 to 20MHz bandwidth.
- *4 open board type: at -5 to +50°C/enclosed type: at -5 to +40°C
- *5 for 7hour period after 1hour warm-up at 25°C and rated input/output
- *6 when output current changed from 25% of rated output current to 75% rapidly at AC100V input
- *7 for less than 1minute of over current and short circuit
- *8 variable change on input voltage and load conditions





ETA-USA

HIGH QUALITY SWITCHING POWER SUPPLIES

BLOCK DIAGRAM

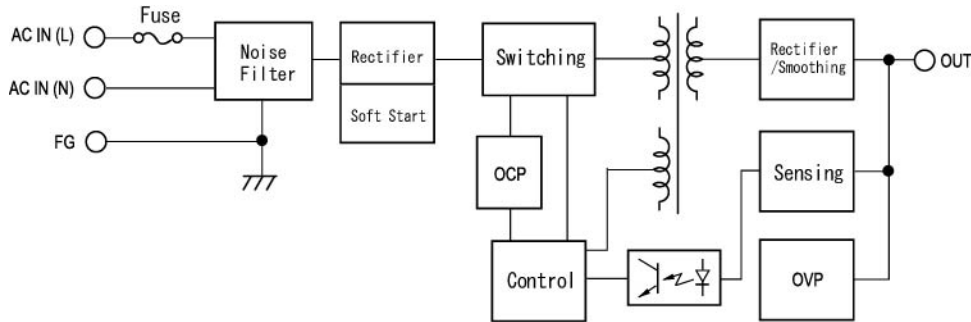

DIMENSION DIAGRAM

BWS-SX-U Series

BWSE-SX-U Series

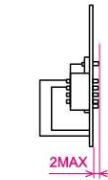
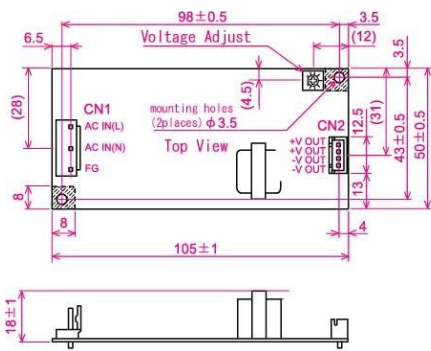

Mating Connector (housing)	
CN1	VHR-6N
CN2	XHP-4

Manufacturer: JST

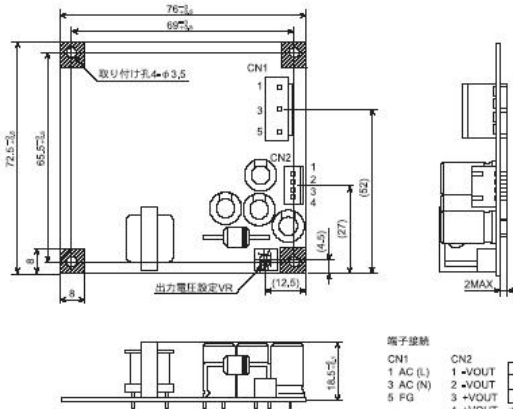

端子接続

CN1	CN2	適合ハウジング
1 AC (L)	1 +VOUT	CN1 VHR-6N
3 AC (N)	2 -VOUT	CN2 XHP-4
5 FG	3 +VOUT	
	4 +VOUT	

メーカー: 日本エーテック電子株式会社

cover comes in touch when installed (dimensions in maximum)

DERATING CURVE

BWS-SX-U Series

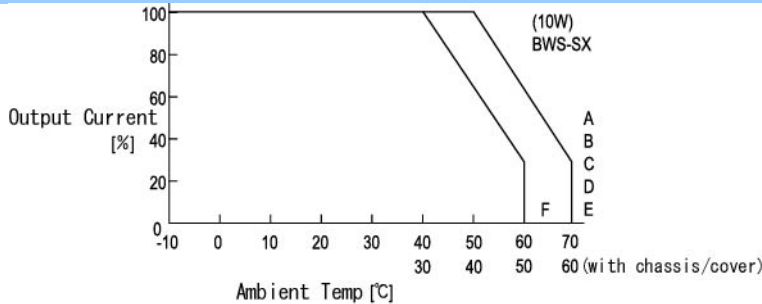

※For safety specification, contact ETA Sales Representative

BWSE-SX-U Series

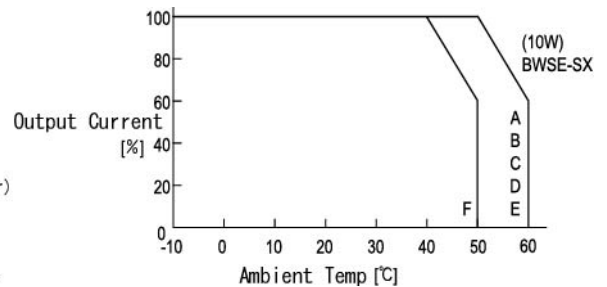

ETA USA
16170 Vineyard Blvd. Suite 180, Morgan Hill, CA 95037
Phone: 1-800-ETA-POWR, (408) 778-2793 Fax: (408) 779-2753

Visit us at: www.eta-usa.com
email at: sales@eta-usa.com



ETA-USA

HIGH QUALITY SWITCHING POWER SUPPLIES

EFFICIENCY CURVES

BWS-SX-U Series

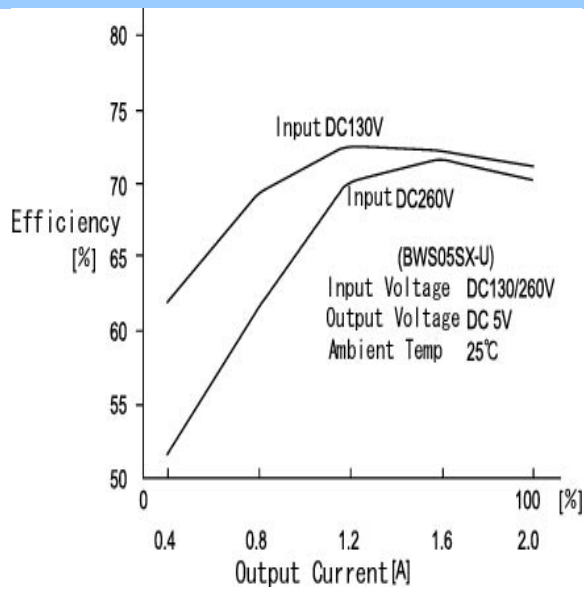

BWSE-SX-U Series

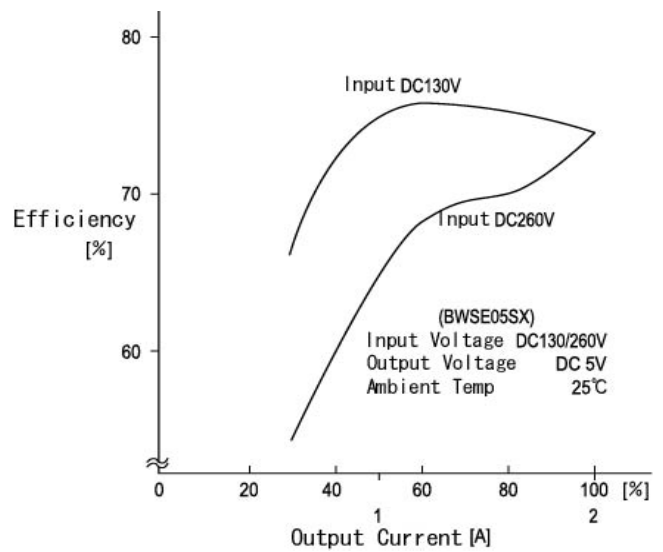

ETA USA

16170 Vineyard Blvd. Suite 180, Morgan Hill, CA 95037
Phone: 1-800-ETA-POWR, (408) 778-2793 Fax: (408) 779-2753

Visit us at: www.eta-usa.com
email at: sales@eta-usa.com



ETA-USA

HIGH QUALITY SWITCHING POWER SUPPLIES

OCP CURVES

BWS-SX-U Series

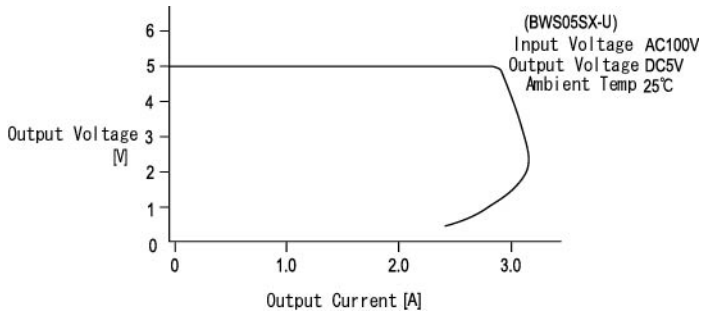

BWSE-SX-U Series

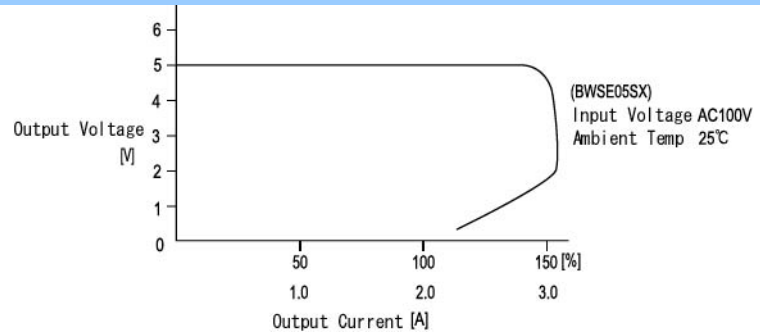

ETA USA

16170 Vineyard Blvd. Suite 180, Morgan Hill, CA 95037
Phone: 1-800-ETA-POWR, (408) 778-2793 Fax: (408) 779-2753

Visit us at: www.eta-usa.com
email at: sales@eta-usa.com

Данный компонент на территории Российской Федерации

Вы можете приобрести в компании MosChip.

Для оперативного оформления запроса Вам необходимо перейти по данной ссылке:

<http://moschip.ru/get-element>

Вы можете разместить у нас заказ для любого Вашего проекта, будь то серийное производство или разработка единичного прибора.

В нашем ассортименте представлены ведущие мировые производители активных и пассивных электронных компонентов.

Нашей специализацией является поставка электронной компонентной базы двойного назначения, продукции таких производителей как XILINX, Intel (ex.ALTERA), Vicor, Microchip, Texas Instruments, Analog Devices, Mini-Circuits, Amphenol, Glenair.

Сотрудничество с глобальными дистрибьюторами электронных компонентов, предоставляет возможность заказывать и получать с международных складов практически любой перечень компонентов в оптимальные для Вас сроки.

На всех этапах разработки и производства наши партнеры могут получить квалифицированную поддержку опытных инженеров.

Система менеджмента качества компании отвечает требованиям в соответствии с ГОСТ Р ИСО 9001, ГОСТ РВ 0015-002 и ЭС РД 009

Офис по работе с юридическими лицами:

105318, г.Москва, ул.Щербаковская д.3, офис 1107, 1118, ДЦ «Щербаковский»

Телефон: +7 495 668-12-70 (многоканальный)

Факс: +7 495 668-12-70 (доб.304)

E-mail: info@moschip.ru

Skype отдела продаж:

moschip.ru

moschip.ru_4

moschip.ru_6

moschip.ru_9